

MONITOUCH

TS series

Connection Manual



Record of Revisions

Reference numbers are shown at the bottom left corner on the back cover of each manual.

Printing Date	Reference No.	Revised Contents
April, 2013	2203NE0	First edition
May, 2013	2203NE1	Second edition

Preface

Thank you for selecting the Techno Shot series (TS series).

For correct set-up of the TS series, you are requested to read through this manual to understand more about the product.

For more information about the TS series, refer to the following related manuals.

Manual Name	Contents	Reference No.
TS Series Hardware Specifications	Notes on usage and hardware specifications for the TS series are explained.	2016NE
TS Series Training Manual	The procedures for creating screens on V-SFT version 5 are explained with examples.	1203NE
V8 Series Reference Manual	The functions and instructions of the V8 series are explained.	1055NE
V8 Series Reference Additional Functions	Functions of the V8 series added to the V-SFT version 5.1.0.0 and later are explained.	1060NE
V series Macro Reference	An overview of macros of V-SFT version 5 as well as macro editor operations and macro command description are explained.	1056NE
V8 Series Operation Manual	The information related to the operations of V-SFT version 5, such as software composition, editing procedure or limitations, is explained in detail.	1058NE
Ladder Monitor Specifications	Instructions for the ladder monitor function are contained.	1045NE
Modbus Slave Communication Specifications	The functions and instructions of the Modbus slave communication are explained.	1046NE
V series DLL Function Specifications	Specifications of DLL files used for Ethernet (HKEtn20.DLL) and CF card (VCFAcs.DLL) are contained.	1059NE

For further details about PLCs, inverters, or temperature controllers, refer to the manual attached to each controller.

Notes:

1. This manual may not, in whole or in part, be printed or reproduced without the prior written consent of Hakko Electronics Co., Ltd.
2. The information in this manual is subject to change without prior notice.
3. Windows and Excel are registered trademarks of Microsoft Corporation in the United States and other countries.
4. All other company names or product names are trademarks or registered trademarks of their respective holders.
5. This manual is intended to give accurate information about TS series hardware. If you have any questions, please contact your local distributor.

Notes on Safe Usage of TS Series

In this manual, you will find various notes categorized under the following two levels with the signal words “Danger” and “Caution”.

 **DANGER** Indicates an imminently hazardous situation which, if not avoided, will result in death or serious injury.

 **CAUTION** Indicates a potentially hazardous situation which, if not avoided, may result in minor or moderate injury and could cause property damage.

Note that there is a possibility that the item listed with  **CAUTION** may have serious ramifications.

DANGER

- Never use the output signal of the TS series for operations that may threaten human life or damage the system, such as signals to be used in case of emergency. Please design the system so that it can cope with the malfunctions of a touch switch. A malfunction of a touch switch will result in machine accident or damage.
- Turn off the power supply when you set up the unit, connect new cables, or perform maintenance or inspections. Otherwise, electrical shock or damage may occur.
- Never touch any terminals while the power is on. Otherwise, electric shock may occur.
- The liquid crystal in the LCD panel is a hazardous substance. If the LCD panel is damaged, do not ingest the leaked liquid crystal. If the liquid crystal spills on skin or clothing, wash off thoroughly with soap.
- Never disassemble, recharge, deform by pressure, short-circuit, reverse the polarity of the lithium battery, nor dispose of the lithium battery in fire. Failure to follow these conditions will lead to explosion or fire.
- Never use a lithium battery that is deformed, leaks, or shows any other signs of abnormality. Failure to follow these conditions will lead to explosion or fire.

CAUTION

- Check the appearance of the TS series when it is unpacked. Do not use the unit if any damage or deformation is found. Failure to do so may lead to fire, damage or malfunction.
- For use in a facility or for a system related to nuclear energy, aerospace, medical, traffic equipment, or mobile installations, please consult your local distributor.
- Operate (or store) the TS series under the conditions indicated in this manual and related manuals. Failure to do so could cause fire, malfunction, physical damage or deterioration.
- Understand the following environmental limits for use and storage of the TS series. Otherwise, fire or damage to the unit may result.
 - Avoid locations where there is a possibility that water, corrosive gas, flammable gas, solvents, grinding fluids or cutting oil can come into contact with the unit.
 - Avoid high temperature, high humidity, and outside weather conditions, such as wind, rain or direct sunlight.
 - Avoid locations where excessive dust, salt, and metallic particles are present.
 - Avoid installing the unit in a location where vibration or physical shock may be transmitted.
- Equipment must be correctly mounted so that the main terminal of the TS series will not be touched inadvertently. Otherwise, electric shock may occur.
- Check periodically that terminal screws on the power supply terminal block and nuts are firmly tightened. Loosened screws may result in fire or malfunction.
- Tighten the terminal screws on the power supply terminal block of the TS series equally to a torque of 0.5 to 0.6 N•m (5 to 6 kgf•cm). Improper tightening of screws may result in fire, malfunction, or other trouble.
- Tighten the nuts of the TS series with an equal torque in the specified range. Excessive tightening may distort the panel surface. Loose tightening may cause the unit to come off, malfunction or be short-circuited.
- The TS series has a glass screen. Do not drop or give physical shock to the unit. Otherwise, the screen may be damaged.
- Connect the cables correctly to the terminals of the TS series in accordance with the specified voltage and wattage. Over-voltage, over-wattage, or incorrect cable connection could cause fire, malfunction or damage to the unit.
- Be sure to establish a ground of the TS series. The FG terminal must be used exclusively for the unit with the level of grounding resistance less than 100 Ω. Otherwise, electric shock or fire may occur.
- Prevent any conductive particles from entering into the TS series. Failure to do so may lead to fire, damage, or malfunction.
- Do not attempt to repair the TS series at your site. Ask Hakko Electronics or the designated contractor for repair.
- Do not repair, disassemble or modify the TS series. Hakko Electronics Co., Ltd. is not responsible for any damages resulting from repair, disassembly or modification of the unit that was performed by an unauthorized person.
- Do not use a sharp-pointed tool when pressing a touch switch. Doing so may damage the display unit.
- Only experts are authorized to set up the unit, connect the cables or perform maintenance and inspection.
- Lithium batteries contain combustible material such as lithium or organic solvent. Mishandling may cause heat, explosion or ignition resulting in fire or injury. Read related manuals carefully and handle the lithium battery correctly as instructed.
- Do not press two or more points on the screen at the same time. If two or more positions are pressed at the same time, a switch located between the pressed positions may be activated.

 **CAUTION**

- Take safety precautions during such operations as setting change during running, forced output, start, and stop. Any misoperation may cause unexpected machine motions, resulting in machine accident or damage.
- In facilities where a failure of the TS series could lead to accident threatening human life or other serious damage, be sure that the facilities are equipped with adequate safeguards.
- At the time of disposal, the TS series must be treated as industrial waste.
- Before touching the TS series, discharge static electricity from your body by touching grounded metal. Excessive static electricity may cause malfunction or trouble.

[General Notes]

- Never bundle control cables nor input/output cables with high-voltage and large-current carrying cables such as power supply cables. Keep these cables at least 200 mm away from the high-voltage and large-current carrying cables. Otherwise, malfunction may occur due to noise.
- When using the TS series in an environment where a source of high-frequency noise is present, it is recommended that the FG shielded cable (communication cable) be grounded at its ends. However, the cable may be grounded only at one end if this is necessary due to unstable communication conditions or for any other reason.
- Plug connectors or sockets of the TS series in the correct orientation. Failure to do so may lead to failure or malfunction.
- Do not use thinners for cleaning because they may discolor the surface of the TS series. Use alcohol or benzine commercially available.
- If a data receive error occurs when the TS series and the counterpart (PLC, temperature controller, etc.) are started at the same time, read the manual for the counterpart unit and remove the error correctly.
- Avoid discharging static electricity on the mounting panel of the TS series. Static charges can damage the unit and cause malfunctions. Otherwise, malfunction may occur due to noise.
- Avoid prolonged display of any fixed pattern. Due to the characteristics of the liquid crystal display, an afterimage may occur. If a prolonged display of a fixed pattern is expected, use the auto OFF function of the backlight.

[Notes on LCD]

Note that the following conditions may occur under normal circumstances.

- The response time, brightness and colors of the TS series may be affected by the ambient temperature.
- Tiny spots (dark or luminescent) may appear on the display due to the liquid crystal characteristics.
- There are variations in brightness and colors on each unit.

Contents

1.	Overview	
1.1	8-way Communication	1-1
1.1.1	Overview	1-1
1.1.2	System Composition	1-2
	Serial Communication	1-2
	Ethernet Communication	1-2
	Mixed Serial-Ethernet Communication	1-3
1.2	Connection Modes	1-4
1.2.1	PLC Connection	1-4
	Serial Communication	1-4
	Ethernet Communication	1-10
1.2.2	Temperature Controller/Servo/Inverter Connection	1-11
	Serial Communication	1-11
1.2.3	Barcode Reader Connection	1-12
	Serial Communication	1-12
	USB Communication	1-12
1.2.4	Slave Communication	1-13
	V-Link	1-13
	Modbus RTU	1-13
	Modbus TCP/IP	1-13
1.2.5	Other Connections	1-13
1.3	Physical Ports	1-14
1.3.1	COM1	1-14
1.3.2	COM2/COM3	1-15
1.3.3	LAN	1-16
1.3.4	USB	1-17
1.4	Wiring	1-18
1.4.1	COM1 Connection	1-18
1.4.2	COM2 Connection	1-20
1.4.3	COM3 Connection	1-21
1.4.4	LAN	1-22
1.4.5	DIP Switch (DIPSW) Setting	1-23
1.5	Settings for the Connected Device	1-24
1.5.1	PLC1 to PLC8	1-24
1.5.2	Read/Write Area	1-27
1.5.3	Others	1-35
2.	ALLEN BRADLEY	
2.1	PLC Connection	2-1
	Serial Connection	2-1
	Ethernet Connection	2-1
2.1.1	PLC-5	2-2
2.1.2	PLC-5 (Ethernet)	2-8
2.1.3	Control Logix / Compact Logix	2-11
2.1.4	Control Logix (Ethernet)	2-14
2.1.5	SLC500	2-16
2.1.6	SLC500 (Ethernet TCP/IP)	2-20
2.1.7	Micro Logix	2-23
2.1.8	Micro Logix (Ethernet TCP/IP)	2-26
2.1.9	NET-ENI (SLC500 Ethernet TCP/IP)	2-29
2.1.10	NET-ENI (MicroLogix Ethernet TCP/IP)	2-33
2.1.11	Wiring Diagrams	2-37
	When Connected at COM1:	2-37
	When Connected at COM2:	2-38

3.	Automationdirect	
3.1	PLC Connection	3-1
	Serial Connection	3-1
	Ethernet Connection	3-1
3.1.1	Direct LOGIC (K-Sequence)	3-2
3.1.2	Direct LOGIC (Ethernet UDP/IP)	3-5
3.1.3	Direct LOGIC (MODBUS RTU)	3-7
3.1.4	Wiring Diagrams	3-9
	When Connected at COM1:	3-9
	When Connected at COM2:	3-10
4.	Baumuller	
4.1	PLC Connection	4-1
	Serial Connection	4-1
4.1.1	BMx-x-PLC	4-2
4.1.2	Wiring Diagrams	4-3
	When Connected at COM1:	4-3
	When Connected at COM2:	4-3
5.	BECKHOFF	
5.1	PLC Connection	5-1
	Ethernet Connection	5-1
5.1.1	ADS Protocol (Ethernet)	5-2
6.	CHINO	
6.1	Temperature Controller/Servo/Inverter Connection	6-1
	Digital Temperature Controller	6-1
	Graphic Recorder	6-2
6.1.1	DP1000	6-3
6.1.2	DB1000B (MODBUS RTU)	6-9
6.1.3	LT230 (MODBUS RTU)	6-10
6.1.4	LT300 (MODBUS RTU)	6-11
6.1.5	LT400 Series (MODBUS RTU)	6-12
6.1.6	LT830 (MODBUS RTU)	6-13
6.1.7	KR2000 (MODBUS RTU)	6-14
6.1.8	Wiring Diagrams	6-15
	When Connected at COM1:	6-15
	When Connected at COM2:	6-16
	When Connected at COM3:	6-17
7.	CIMON	
7.1	PLC Connection	7-1
	Serial Connection	7-1
7.1.1	BP Series	7-2
7.1.2	CP Series	7-5
7.1.3	Wiring Diagrams	7-8
	When Connected at COM1:	7-8
	When Connected at COM2:	7-10
	When Connected at COM3:	7-11
8.	DELTA	
8.1	PLC Connection	8-1
	Serial Connection	8-1
8.1.1	DVP Series	8-2
8.1.2	Wiring Diagrams	8-3
	When Connected at COM1:	8-3
	When Connected at COM2:	8-3
	When Connected at COM3:	8-3

9. DELTA TAU DATA SYSTEMS

9.1	Temperature Controller/Servo/Inverter Connection	9-1
	Serial Connection	9-1
	Ethernet Connection	9-1
9.1.1	PMAC	9-2
9.1.2	PMAC (Ethernet TCP/IP)	9-5
9.1.3	Wiring Diagrams	9-9
	When Connected at COM2:	9-9

10. EATON Cutler-Hammer

10.1	PLC Connection	10-1
	Serial Connection	10-1
10.1.1	ELC	10-2
10.1.2	Wiring Diagrams	10-3
	When Connected at COM1:	10-3
	When Connected at COM2:	10-3
	When Connected at COM3:	10-3

11. EMERSON

11.1	PLC Connection	11-1
	Serial Connection	11-1
11.1.1	EC10/EC20/EC20H (MODBUS RTU)	11-2
11.1.2	Wiring Diagrams	11-3
	When Connected at COM1:	11-3
	When Connected at COM2:	11-3
	When Connected at COM3:	11-3

12. FANUC

12.1	PLC Connection	12-1
	Serial Connection	12-1
12.1.1	Power Mate	12-2
12.1.2	Wiring Diagrams	12-3
	When Connected at COM1:	12-3
	When Connected at COM2:	12-4

13. Fatek Automation

13.1	PLC Connection	13-1
	Serial Connection	13-1
13.1.1	FACON FB Series	13-2
13.1.2	Wiring Diagrams	13-3
	When Connected at COM1:	13-3
	When Connected at COM2:	13-4
	When Connected at COM3:	13-4

14. FUFENG

14.1	PLC Connection	14-1
	Serial Connection	14-1
14.1.1	APC Series Controller	14-2
14.1.2	Wiring Diagrams	14-4
	When Connected at COM1:	14-4
	When Connected at COM2:	14-4
	When Connected at COM3:	14-5

15. Fuji Electric

15.1	PLC Connection	15-1
	Serial Connection	15-1
	Ethernet Connection	15-2
	MICREX-SX Model Selection	15-3
15.1.1	MICREX-F Series	15-4
15.1.2	SPB (N Mode) & FLEX-PC Series	15-7

15.1.3	SPB (N Mode) & FLEX-PC CPU	15-9
15.1.4	MICREX-SX SPH/SPB Series (IEC Mode)	15-10
15.1.5	MICREX-SX SPH/SPB Series (N Mode / F Mode)	15-12
15.1.6	MICREX-SX SPH/SPB CPU (IEC Mode)	15-13
15.1.7	MICREX-SX SPH/SPB CPU (N Mode / F Mode)	15-13
15.1.8	MICREX-SX (Ethernet)	15-14
15.1.9	Wiring Diagrams	15-17
	When Connected at COM1:	15-17
	When Connected at COM2:	15-18
	When Connected at COM3:	15-19
15.2	Temperature Controller/Servo/Inverter Connection	15-20
	Temperature Controller	15-20
	Power Monitor Unit	15-20
	Inverter	15-21
	IH Inverter	15-21
	AC Power Monitor	15-21
	Servo Amplifier	15-22
	Controller	15-22
	Recorder	15-22
	Digital Panel Meter	15-22
	AC Power Regulator	15-22
	Electronic Multimeter	15-23
15.2.1	PYX (MODBUS RTU)	15-24
15.2.2	PXR (MODBUS RTU)	15-25
15.2.3	PXG (MODBUS RTU)	15-26
15.2.4	PXH (MODBUS RTU)	15-27
15.2.5	PUM (MODBUS RTU)	15-28
15.2.6	F-MPC04P (Loader)	15-30
15.2.7	F-MPC Series / FePSU	15-34
15.2.8	FVR-E11S	15-41
15.2.9	FVR-E11S (MODBUS RTU)	15-43
15.2.10	FVR-C11S (MODBUS RTU)	15-44
15.2.11	FRENIC5000 G11S / P11S	15-45
15.2.12	FRENIC5000 G11S / P11S (MODBUS RTU)	15-47
15.2.13	FRENIC5000 VG7S (MODBUS RTU)	15-48
15.2.14	FRENIC-Mini (MODBUS RTU)	15-50
15.2.15	FRENIC-Eco (MODBUS RTU)	15-52
15.2.16	FRENIC-Multi (MODBUS RTU)	15-54
15.2.17	FRENIC-MEGA (MODBUS RTU)	15-56
15.2.18	FRENIC-MEGA SERVO (MODBUS RTU)	15-58
15.2.19	FRENIC-HVAC/AQUA (MODBUS RTU)	15-60
15.2.20	HFR-C9K	15-62
15.2.21	HFR-C11K	15-64
15.2.22	PPMC (MODBUS RTU)	15-66
15.2.23	FALDIC- α Series	15-67
15.2.24	FALDIC-W Series	15-69
15.2.25	PH Series	15-71
15.2.26	PHR (MODBUS RTU)	15-73
15.2.27	WA5000	15-74
15.2.28	APR-N (MODBUS RTU)	15-82
15.2.29	ALPHA5 (MODBUS RTU)	15-83
15.2.30	ALPHA5 Smart (MODBUS RTU)	15-85
15.2.31	WE1MA (Ver. A) (MODBUS RTU)	15-87
15.2.32	WE1MA (Ver. B) (MODBUS RTU)	15-88
15.2.33	WSZ Series	15-89
15.2.34	Wiring Diagrams	15-91
	When Connected at COM1:	15-91
	When Connected at COM2:	15-96
	When Connected at COM3:	15-97

16. GE Fanuc

16.1	PLC Connection	16-1
	Serial Connection	16-1
	Ethernet Connection	16-2
16.1.1	90 Series	16-3
16.1.2	90 Series (SNP-X)	16-5
16.1.3	90 Series (SNP)	16-6
16.1.4	90 Series (Ethernet TCP/IP)	16-8
16.1.5	RX3i (Ethernet TCP/IP)	16-9

16.1.6	Wiring Diagrams	16-10
	When Connected at COM1:	16-10
	When Connected at COM2:	16-11
	When Connected at COM3:	16-12
17.	Hitachi	
17.1	PLC Connection	17-1
	Serial Connection	17-1
	Ethernet Connection	17-1
17.1.1	HIDIC-S10/2 α , S10mini	17-2
17.1.2	HIDIC-S10/2 α , S10mini (Ethernet)	17-4
17.1.3	HIDIC-S10/4 α	17-5
17.1.4	HIDIC-S10V	17-6
17.1.5	HIDIC-S10V (Ethernet)	17-8
17.1.6	Wiring Diagrams	17-10
	When Connected at COM1:	17-10
	When Connected at COM2:	17-10
18.	Hitachi Industrial Equipment Systems	
18.1	PLC Connection	18-1
	Serial Connection	18-1
	Ethernet Connection	18-2
18.1.1	HIDIC-H	18-2
18.1.2	HIDIC-H (Ethernet)	18-8
18.1.3	HIDIC-EHV	18-9
18.1.4	HIDIC-EHV (Ethernet)	18-11
18.1.5	Wiring Diagrams	18-12
	When Connected at COM1:	18-12
	When Connected at COM2:	18-14
	When Connected at COM3:	18-15
18.2	Temperature Controller/Servo/Inverter Connection	18-17
	Inverter	18-17
18.2.1	SJ300 Series	18-18
18.2.2	SJ700 Series	18-22
18.2.3	Wiring Diagrams	18-26
	When Connected at COM1:	18-26
	When Connected at COM3:	18-26
19.	IAI	
19.1	Temperature Controller/Servo/Inverter Connection	19-1
	Serial Connection	19-1
19.1.1	X-SEL Controller	19-2
19.1.2	ROBO CYLINDER (RCP2/ERC)	19-12
19.1.3	ROBO CYLINDER (RCS/E-CON)	19-15
19.1.4	PCON / ACON / SCON (MODBUS RTU)	19-18
19.1.5	Wiring Diagrams	19-20
	When Connected at COM1:	19-20
	When Connected at COM2:	19-20
	When Connected at COM3:	19-22
20.	IDEC	
20.1	PLC Connection	20-1
	Serial Connection	20-1
20.1.1	MICRO 3	20-2
20.1.2	MICRO Smart	20-3
20.1.3	MICRO Smart Pentra	20-4
20.1.4	Wiring Diagrams	20-5
	When Connected at COM1:	20-5
	When Connected at COM2:	20-5
	When Connected at COM3:	20-7

21.	Jetter	
21.1	PLC Connection	21-1
	Ethernet Connection	21-1
21.1.1	JetControl Series2/3 (Ethernet UDP/IP)	21-2
22.	JTEKT	
22.1	PLC Connection	22-1
	Serial Connection	22-1
	Ethernet Connection	22-1
22.1.1	TOYOPUC	22-2
22.1.2	TOYOPUC (Ethernet)	22-5
22.1.3	TOYOPUC (Ethernet PC10 Mode)	22-7
22.1.4	Wiring Diagrams	22-11
	When Connected at COM1:	22-11
	When Connected at COM3:	22-11
23.	KEYENCE	
23.1	PLC Connection	23-1
	Serial Connection	23-1
	Ethernet Connection	23-1
23.1.1	KZ-A500 CPU	23-2
23.1.2	KV10/24 CPU	23-3
23.1.3	KV-700	23-4
23.1.4	KV-700 (Ethernet TCP/IP)	23-6
23.1.5	KV-1000	23-7
23.1.6	KV-1000 (Ethernet TCP/IP)	23-9
23.1.7	KV-3000 / 5000	23-10
23.1.8	KV-3000 / 5000 (Ethernet TCP/IP)	23-12
23.1.9	Wiring Diagrams	23-13
	When Connected at COM1:	23-13
	When Connected at COM2:	23-13
24.	KOYO ELECTRONICS	
24.1	PLC Connection	24-1
	Serial Connection	24-1
24.1.1	SU/SG	24-2
24.1.2	SR-T (K Protocol)	24-9
24.1.3	SU/SG (K-Sequence)	24-10
24.1.4	SU/SG (MODBUS RTU)	24-13
24.1.5	Wiring Diagrams	24-16
	When Connected at COM1:	24-16
	When Connected at COM2:	24-18
	When Connected at COM3:	24-19
25.	LS	
25.1	PLC Connection	25-1
	Serial Connection	25-1
	Ethernet Connection	25-2
25.1.1	MASTER-KxxxS	25-3
25.1.2	MASTER-KxxxS CNET	25-4
25.1.3	GLOFA CNET	25-6
25.1.4	GLOFA GM7 CNET	25-8
25.1.5	GLOFA GM Series CPU	25-9
25.1.6	GLOFA GM Series (Ethernet UDP/IP)	25-10
25.1.7	XGT/XGK Series CNET	25-11
25.1.8	XGT/XGK Series CPU	25-13
25.1.9	XGT / XGK Series (Ethernet)	25-13
25.1.10	XGT / XGI Series CNET	25-14
25.1.11	XGT / XGI Series CPU	25-16
25.1.12	XGT / XGI Series (Ethernet)	25-18

25.1.13	Wiring Diagrams	25-19
	When Connected at COM1:	25-19
	When Connected at COM2:	25-19
	When Connected at COM3:	25-20

26. MITSUBISHI ELECTRIC

26.1	PLC Connection	26-1
	Serial Connection	26-1
	Ethernet Connection	26-4
26.1.1	A Series Link	26-6
26.1.2	QnA Series Link	26-8
26.1.3	QnA Series (Ethernet)	26-10
26.1.4	QnH (Q) Series Link	26-13
26.1.5	QnH (Q) Series CPU	26-15
26.1.6	QnH (Q) Series (Ethernet)	26-16
26.1.7	QnU Series CPU	26-19
26.1.8	Q00J/00/01 CPU	26-19
26.1.9	QnH (Q) Series Link (Multi CPU)	26-19
26.1.10	QnH (Q) Series (Multi CPU) (Ethernet)	26-19
26.1.11	QnH (Q) Series CPU (Multi CPU)	26-19
26.1.12	QnH (Q) Series (Ethernet ASCII)	26-20
26.1.13	QnH (Q) Series (Multi-CPU) (Ethernet ASCII)	26-23
26.1.14	QnU Series (Built-in Ethernet)	26-24
26.1.15	L Series Link	26-27
26.1.16	L Series (Built-in Ethernet)	26-29
26.1.17	FX2N/1N Series CPU	26-32
26.1.18	FX1S Series CPU	26-33
26.1.19	FX Series Link (A Protocol)	26-34
26.1.20	FX-3U/3UC/3G Series CPU	26-36
26.1.21	FX-3U Series (Ethernet)	26-37
26.1.22	FX3U/3UC/3G Series Link (A Protocol)	26-40
26.1.23	Q170MCP (Multi CPU)	26-42
26.1.24	Q170 Series (Multi CPU) (Ethernet)	26-44
26.1.25	Wiring Diagrams	26-47
	When Connected at COM1:	26-47
	When Connected at COM2:	26-48
	When Connected at COM3:	26-49
26.2	Temperature Controller/Servo/Inverter Connection	26-50
	Inverter	26-50
	Servo	26-50
26.2.1	FR-*500	26-51
26.2.2	FR-V500	26-54
26.2.3	MR-J2S-*A	26-57
26.2.4	MR-J3-*A	26-59
26.2.5	MR-J3-*T	26-61
26.2.6	FR-E700	26-64
26.2.7	Wiring Diagrams	26-68
	When Connected at COM1:	26-68
	When Connected at COM2:	26-68
	When Connected at COM3:	26-69

27. MODICON

27.1	PLC Connection	27-1
	Serial Connection	27-1
27.1.1	Modbus RTU	27-2
27.1.2	Wiring Diagrams	27-3
	When Connected at COM2:	27-3

28. MOELLER

28.1	PLC Connection	28-1
	Serial Connection	28-1
28.1.1	PS4	28-2
28.1.2	Wiring Diagrams	28-3
	When Connected at COM2:	28-3

29. M-SYSTEM

29.1	Temperature Controller/Servo/Inverter Connection	29-1
	Remote I/O	29-1
29.1.1	R1M Series	29-2
29.1.2	Wiring Diagrams	29-3
	When Connected at COM1:	29-3
	When Connected at COM2:	29-3
	When Connected at COM3:	29-3

30. OMRON

30.1	PLC Connection	30-1
	Serial Connection	30-1
	Ethernet Connection	30-3
30.1.1	SYSMAC C	30-4
30.1.2	SYSMAC CV	30-9
30.1.3	SYSMAC CS1/CJ1	30-12
30.1.4	SYSMAC CS1/CJ1 (DNA)	30-16
30.1.5	SYSMAC CS1/CJ1 (Ethernet)	30-18
30.1.6	SYSMAC CS1/CJ1 (Ethernet Auto)	30-20
30.1.7	SYSMAC CS1/CJ1 DNA (Ethernet)	30-22
30.1.8	Wiring Diagrams	30-25
	When Connected at COM1:	30-25
	When Connected at COM2:	30-26
	When Connected at COM3:	30-27
30.2	Temperature Controller/Servo/Inverter Connection	30-28
	Temperature Controller	30-28
	ID Controller	30-29
	Power Meter	30-29
30.2.1	E5AK	30-30
30.2.2	E5AK-T	30-31
30.2.3	E5AN/E5EN/E5CN/E5GN	30-32
30.2.4	E5AR/E5ER	30-34
30.2.5	E5CK	30-37
30.2.6	E5CK-T	30-38
30.2.7	E5CN-HT	30-39
30.2.8	E5EK	30-41
30.2.9	E5ZD	30-42
30.2.10	E5ZE	30-44
30.2.11	E5ZN	30-47
30.2.12	V600/620/680	30-49
30.2.13	KM20	30-56
30.2.14	KM100	30-58
30.2.15	Wiring Diagrams	30-60
	When Connected at COM1:	30-60
	When Connected at COM2:	30-62
	When Connected at COM3:	30-63

31. Oriental Motor

31.1	Temperature Controller / Servo / Inverter Connection	31-1
	Stepping Motor	31-1
31.1.1	High-efficiency AR Series (MODBUS RTU)	31-2
31.1.2	CRK Series (MODBUS RTU)	31-4
31.1.3	Wiring diagram	31-6
	When Connected at COM1:	31-6
	When Connected at COM3:	31-6

32. Panasonic

32.1	PLC Connection	32-1
	Serial Connection	32-1
	Ethernet Connection	32-2
32.1.1	FP Series (RS232C/422)	32-3
32.1.2	FP Series (TCP/IP)	32-7
32.1.3	FP Series (UDP/IP)	32-10
32.1.4	FP-X (TCP/IP)	32-13

32.1.5	Wiring Diagrams	32-16
	When Connected at COM1:	32-16
	When Connected at COM2:	32-16
	When Connected at COM3:	32-18
32.2	Temperature Controller/Servo/Inverter Connection	32-19
	Serial Connection	32-19
32.2.1	LP-400 Series	32-20
32.2.2	KW Series	32-56
32.2.3	MINAS A4 Series	32-59
32.2.4	Wiring Diagrams	32-62
	When Connected at COM1:	32-62
	When Connected at COM2:	32-63
	When Connected at COM3:	32-64
33.	RKC	
33.1	Temperature Controller/Servo/Inverter Connection	33-1
	Serial Connection	33-1
33.1.1	CB100/CB400/CB500/CB700/CB900 (MODBUS RTU)	33-2
33.1.2	SRV (MODBUS RTU)	33-3
33.1.3	SR-Mini (MODBUS RTU)	33-4
33.1.4	SR-Mini (Standard Protocol)	33-5
33.1.5	REX-F400/F700/F900 (Standard Protocol)	33-6
33.1.6	MA900 / MA901 (MODBUS RTU)	33-7
33.1.7	SRZ (MODBUS RTU)	33-8
33.1.8	FB100/FB400/FB900 (MODBUS RTU)	33-9
33.1.9	Wiring Diagrams	33-11
	When Connected at COM1:	33-11
	When Connected at COM2:	33-12
	When Connected at COM3:	33-12
34.	RS Automation	
34.1	PLC Connection	34-1
	Serial Connection	34-1
	Ethernet Connection	34-2
34.1.1	NX7/NX Plus Series (70P/700P/CCU+)	34-3
34.1.2	N7/NX Series (70/700/750/CCU)	34-6
34.1.3	X8 Series	34-7
34.1.4	NX700 Series (Ethernet)	34-11
34.1.5	X8 Series (Ethernet)	34-14
34.1.6	Wiring Diagrams	34-16
	When Connected at COM1:	34-16
	When Connected at COM2:	34-17
	When Connected at COM3:	34-20
35.	SAIA	
35.1	PLC Connection	35-1
	Serial Connection	35-1
	Ethernet Connection	35-1
35.1.1	PCD	35-2
35.1.2	PCD S-BUS (Ethernet)	35-3
35.1.3	Wiring Diagrams	35-4
	When Connected at COM1:	35-4
	When Connected at COM2:	35-4
	When Connected at COM3:	35-5
36.	SAMSUNG	
36.1	PLC Connection	36-1
	Serial Connection	36-1
36.1.1	N_plus	36-2
36.1.2	SENET	36-6

36.1.3	Wiring Diagrams	36-7
	When Connected at COM1:	36-7
	When Connected at COM2:	36-7
	When Connected at COM3:	36-9
37.	SanRex	
37.1	Temperature Controller / Servo / Inverter Connection	37-1
	Serial Connection	37-1
37.1.1	DC AUTO (HKD type)	37-2
37.1.2	Wiring Diagrams	37-3
	When Connected at COM1:	37-3
38.	SANMEI	
38.1	Temperature Controller/Servo/Inverter Connection	38-1
	AC Servo Driver	38-1
38.1.1	Cuty Axis	38-2
38.1.2	Wiring Diagrams	38-7
	When Connected at COM1:	38-7
	When Connected at COM2:	38-7
39.	SHARP	
39.1	PLC Connection	39-1
	Serial Connection	39-1
	Ethernet Connection	39-2
39.1.1	JW Series	39-3
39.1.2	JW100/70H COM Port	39-6
39.1.3	JW20 COM Port	39-8
39.1.4	JW300 Series	39-10
39.1.5	JW Series (Ethernet)	39-13
39.1.6	JW311/312/321/322 Series (Ethernet)	39-17
39.1.7	JW331/332/341/342/352/362 Series (Ethernet)	39-18
39.1.8	Wiring Diagrams	39-19
	When Connected at COM1:	39-19
	When Connected at COM2:	39-21
	When Connected at COM3:	39-22
39.2	Temperature Controller/Servo/Inverter Connection	39-23
	ID Controller	39-23
39.2.1	DS-30D	39-24
39.2.2	DS-32D	39-29
39.2.3	Wiring Diagrams	39-34
	When Connected at COM1:	39-34
	When Connected at COM2:	39-34
	When Connected at COM3:	39-35
40.	SHIMADEN	
40.1	Temperature Controller / Servo / Inverter Connection	40-1
	Controller / Indicator / Servo Controller	40-1
40.1.1	SHIMADEN Standard Protocol	40-2
40.1.2	Wiring Diagrams	40-7
	When Connected at COM1:	40-7
	When Connected at COM2:	40-8
	When Connected at COM3:	40-8
41.	SHINKO TECHNOS	
41.1	Temperature Controller/Servo/Inverter Connection	41-1
	Serial Connection	41-1
41.1.1	C Series	41-2
41.1.2	FC Series	41-4
41.1.3	GC Series	41-5
41.1.4	JCx-300 Series	41-6
41.1.5	ACS-13A	41-7
41.1.6	ACD/ACR Series	41-8

41.1.7	WCL-13A	41-9
41.1.8	DCL-33A	41-10
41.1.9	PCD-33A	41-11
41.1.10	PC-900	41-12
41.1.11	Wiring Diagrams	41-13
	When Connected at COM1:	41-13
	When Connected at COM2:	41-14
	When Connected at COM3:	41-15

42. Siemens

42.1	PLC Connection	42-1
	Serial Connection	42-1
	Ethernet Connection	42-2
42.1.1	S5 (PG Port)	42-3
42.1.2	S7	42-5
42.1.3	S7-200PPI	42-6
42.1.4	S7-200(Ethernet ISOTCP)	42-8
42.1.5	S7-300/400MPI	42-11
42.1.6	S7-300/400 (Ethernet ISOTCP)	42-13
42.1.7	S7-300/400 (Ethernet TCP/IP PG Protocol)	42-15
42.1.8	S7-1200 (Ethernet ISOTCP)	42-17
42.1.9	TI500 / 505 Series	42-21
42.1.10	Wiring Diagrams	42-23
	When Connected at COM1:	42-23
	When Connected at COM2:	42-24
	When Connected at COM3:	42-25

43. SINFONIA TECHNOLOGY

43.1	PLC Connection	43-1
	Serial Connection	43-1
43.1.1	SELMART	43-2
43.1.2	Wiring Diagrams	43-4
	When Connected at COM2:	43-4

44. TECO

44.1	PLC Connection	44-1
	Serial Connection	44-1
44.1.1	TP03 (MODBUS RTU)	44-2
44.1.2	Wiring Diagrams	44-4
	When Connected at COM1:	44-4
	When Connected at COM2:	44-4
	When Connected at COM3:	44-5

45. Telemecanique

45.1	PLC Connection	45-1
	Serial Connection	45-1
45.1.1	TSX Micro	45-2
45.1.2	Wiring Diagrams	45-3
	When Connected at COM1:	45-3
	When Connected at COM3:	45-3

46. TOHO

46.1	Temperature Controller/Servo/Inverter Connection	46-1
	Digital Temperature Controller	46-1
46.1.1	TTM-000	46-2
46.1.2	TTM-00BT	46-4
46.1.3	TTM-200 (MODBUS RTU)	46-6
46.1.4	Wiring Diagrams	46-7
	When Connected at COM1:	46-7
	When Connected at COM2:	46-9
	When Connected at COM3:	46-9

47. TOSHIBA

47.1	PLC Connection	47-1
	Serial Connection	47-1
47.1.1	T Series / TS series (T Compatible)	47-2
47.1.2	EX Series	47-6
47.1.3	Wiring Diagrams	47-8
	When Connected at COM1:	47-8
	When Connected at COM2:	47-9
47.2	Temperature Controller/Servo/Inverter Connection	47-10
	Inverter	47-10
47.2.1	VF-S7	47-11
47.2.2	VF-S9	47-13
47.2.3	VF-S11	47-15
47.2.4	VF-A7	47-18
47.2.5	VF-AS1	47-20
47.2.6	VF-P7	47-22
47.2.7	VF-PS1	47-22
47.2.8	VF-FS1	47-23
47.2.9	VF-nC1	47-24
47.2.10	Wiring Diagrams	47-26
	When Connected at COM1:	47-26
	When Connected at COM2:	47-27
	When Connected at COM3:	47-28

48. TOSHIBA MACHINE

48.1	PLC Connection	48-1
	Serial Connection	48-1
48.1.1	TC200	48-2
48.1.2	Wiring Diagrams	48-7
	When Connected at COM1:	48-7
	When Connected at COM2:	48-8
	When Connected at COM3:	48-9
48.2	Temperature Controller/Servo/Inverter Connection	48-10
	Servo Amplifier	48-10
48.2.1	VELCONIC Series	48-11
48.2.2	Wiring Diagrams	48-14
	When Connected at COM1:	48-14
	When Connected at COM3:	48-14

49. UNIPULSE

49.1	Temperature Controller/Servo/Inverter Connection	49-1
	Digital Indicator	49-1
	Load Cell Indicator	49-1
	Weighing Controller	49-1
49.1.1	F340A	49-2
49.1.2	F371	49-4
49.1.3	F800	49-7
49.1.4	F720A	49-11
49.1.5	Wiring Diagrams	49-15
	When Connected at COM1:	49-15
	When Connected at COM2:	49-15
	When Connected at COM3:	49-16

50. UNITRONICS

50.1	PLC Connection	50-1
	Serial Connection	50-1
	Ethernet Connection	50-1
50.1.1	M90/M91/Vision Series (ASCII)	50-2
50.1.2	Vision Series (ASCII Ethernet TCP/IP)	50-8

50.1.3	Wiring Diagrams	50-12
	When Connected at COM1:	50-12
	When Connected at COM2:	50-12
	When Connected at COM3:	50-12
51.	VIGOR	
51.1	PLC Connection	51-1
	Serial Connection	51-1
51.1.1	M Series	51-2
51.1.2	Wiring Diagrams	51-3
	When Connected at COM1:	51-3
	When Connected at COM2:	51-3
	When Connected at COM3:	51-3
52.	WAGO	
52.1	PLC Connection	52-1
	Serial Connection	52-1
	Ethernet Connection	52-1
52.1.1	750 Series (MODBUS RTU)	52-2
52.1.2	750 Series (MODBUS Ethernet)	52-6
52.1.3	Wiring Diagrams	52-10
	When Connected at COM1:	52-10
	When Connected at COM2:	52-10
	When Connected at COM3:	52-10
53.	YAMAHA	
53.1	Temperature Controller/Servo/Inverter Connection	53-1
	Serial Connection	53-1
53.1.1	RCX142	53-2
53.1.2	Wiring Diagrams	53-16
	When Connected at COM2:	53-16
54.	Yamatake	
54.1	PLC Connection	54-1
	Serial Connection	54-1
54.1.1	MX Series	54-2
54.1.2	Wiring Diagrams	54-4
	When Connected at COM2:	54-4
54.2	Temperature Controller/Servo/Inverter Connection	54-5
	Serial Connection	54-5
	Ethernet Connection	54-6
54.2.1	SDC10	54-7
54.2.2	SDC20	54-8
54.2.3	SDC21	54-8
54.2.4	SDC30/31	54-9
54.2.5	SDC35/36	54-10
54.2.6	SDC40A	54-11
54.2.7	SDC40G	54-11
54.2.8	DMC10	54-12
54.2.9	DMC50 (COM)	54-13
54.2.10	AHC2001	54-17
54.2.11	AHC2001+DCP31/32	54-20
54.2.12	DCP31/32	54-23
54.2.13	NX (CPL)	54-24
54.2.14	NX (MODBUS RTU)	54-25
54.2.15	NX (MODBUS TCP/IP)	54-26
54.2.16	Wiring Diagrams	54-28
	When Connected at COM1:	54-28
	When Connected at COM2:	54-29
	When Connected at COM3:	54-30

55. Yaskawa Electric

55.1	PLC Connection	55-1
	Serial Connection	55-1
	Ethernet Connection	55-2
55.1.1	Memobus	55-3
55.1.2	CP9200SH/MP900	55-4
55.1.3	MP2300 (MODBUS TCP/IP)	55-6
55.1.4	CP/MP Expansion Memobus (UDP/IP)	55-8
55.1.5	MP2000 Series	55-9
55.1.6	MP2000 Series (UDP/IP)	55-10
55.1.7	Wiring Diagrams	55-11
	When Connected at COM1:	55-11
	When Connected at COM2:	55-13
	When Connected at COM3:	55-14

56. Yokogawa Electric

56.1	PLC Connection	56-1
	Serial Connection	56-1
	Ethernet Connection	56-2
56.1.1	FA-M3/FA-M3R	56-3
56.1.2	FA-M3/FA-M3R (Ethernet UDP/IP)	56-10
56.1.3	FA-M3/FA-M3R (Ethernet UDP/IP ASCII)	56-12
56.1.4	FA-M3/FA-M3R (Ethernet TCP/IP)	56-14
56.1.5	FA-M3/FA-M3R (Ethernet TCP/IP ASCII)	56-16
56.1.6	Wiring Diagrams	56-18
	When Connected at COM1:	56-18
	When Connected at COM2:	56-18
	When Connected at COM3:	56-19
56.2	Temperature Controller/Servo/Inverter Connection	56-20
	Temperature Controller	56-20
	Digital Indicating Controller	56-20
	Multi-point Temperature Controller	56-20
56.2.1	UT100	56-21
56.2.2	UT750	56-22
56.2.3	UT550	56-23
56.2.4	UT520	56-23
56.2.5	UT350	56-23
56.2.6	UT320	56-23
56.2.7	UT450	56-23
56.2.8	UT2400/2800	56-24
56.2.9	Wiring Diagrams	56-26
	When Connected at COM1:	56-26
	When Connected at COM3:	56-27

57. MODBUS

57.1	PLC Connection	57-1
	Serial Connection	57-1
	Ethernet Connection	57-1
57.1.1	MODBUS RTU	57-2
57.1.2	MODBUS RTU EXT Format	57-4
57.1.3	MODBUS TCP/IP (Ethernet)	57-8
57.1.4	MODBUS TCP/IP (Ethernet) EXT Format	57-9
57.1.5	MODBUS TCP/IP (Ethernet) Sub Station	57-13
57.1.6	Wiring Diagrams	57-15
	When Connected at COM1:	57-15
	When Connected at COM2:	57-15
	When Connected at COM3:	57-16

58. Barcode Reader

58.1	Barcode Reader Connection	58-1
	Serial Connection	58-1
	USB Connection	58-1
58.1.1	Communication Setting	58-2
58.1.2	I/F Memory	58-3

58.1.3	Control Memory	58-4
58.1.4	Wiring Diagrams	58-5
	When Connected at COM2:	58-5

59. Slave Communication Function

59.1	V-Link	59-1
59.1.1	Overview	59-1
59.1.2	Communication Setting	59-2
	Editor	59-2
	TS series	59-3
59.1.3	Wiring Diagrams	59-4
	When Connected at COM1:	59-4
	When Connected at COM2:	59-5
	When Connected at COM3:	59-6
59.1.4	Protocol	59-7
59.1.5	1-byte Character Code List	59-12
59.2	Modbus RTU Slave Communication	59-13
59.3	Modbus TCP/IP Slave Communication	59-13

60. Universal Serial Communication

60.1	Overview	60-1
	Overview of Communication	60-1
	Differences between Connecting to General-purpose Computer and Connecting to PLC	60-2
	System Configuration	60-2
60.2	Wiring Diagrams	60-3
	When Connected at COM1:	60-3
	When Connected at COM2:	60-4
	When Connected at COM3:	60-5
60.3	Device Connection Setting	60-6
	PLC1	60-6
	Read/Write Area	60-9
60.4	Standard Type Protocol	60-11
60.4.1	Standard Type Protocol	60-11
	Connection (1 : 1), Transmission Mode (with Sum Check)	60-12
	Connection (1 : 1), Transmission Mode (with Sum Check and CR/LF)	60-13
	Connection (1 : n), Transmission Mode (with Sum Check)	60-14
	Connection (1 : n), Transmission Mode (with Sum Check and CR/LF)	60-15
60.4.2	Protocol Contents	60-16
	Transmission Control Code	60-16
	Port Number	60-16
	Command	60-16
	Sum Check Code (SUM)	60-17
	Error Codes	60-17
	Response Time and BUSY	60-18
60.4.3	Command	60-19
	RC: Read CHR	60-19
	RM: Read Memory	60-20
	WC: Write CHR	60-21
	WM: Write Memory	60-22
	TR: Retry Command	60-23
	WI: Interrupt Setting Command	60-24
	RI: Interrupt Status Read Command	60-25
60.4.4	Interrupt (ENQ)	60-26
	1-byte Character Code List	60-28
60.5	Memory Map	60-29
	Memory	60-29
	User Memory (\$u)	60-29
	System Memory (\$s)	60-30

Appendix

Appendix 1 Device Memory Map

Device Memory Map Editing	App1-3
Periodical Reading	App1-7
Synchronized Reading	App1-8
Periodical Writing	App1-9
Synchronized Writing	App1-10
Control Memory	App1-11
Sampling	App1-12
TBL_READ / TBL_WRITE	App1-14

Appendix 2 Ethernet

Overview	App2-1
PLC Communication	App2-2
Macro EREAD/EWRITE	App2-4
Connection with Computer	App2-5
Screen Data Transfer	App2-6
E-Mail	App2-6
Web Server	App2-6
IP Address Setting of the TS Series	App2-7
Network Table	App2-10
Macro	App2-12
System Memory	App2-15
Error Display	App2-17

Appendix 3 System Memory

Appendix 4 n : 1 Connection

Appendix 4.1	Multi-link2	App4-1
	System Configuration and Wiring Diagram	App4-2
	Setting on the Editor	App4-4
	Communication Error	App4-5
Appendix 4.2	Multi-link2 (Ethernet)	App4-6
	Available Models	App4-6
	Setting on the Editor	App4-7
	Communication Error	App4-8
Appendix 4.3	1 : n Multi-link2 (Ethernet)	App4-9
	Available Models	App4-9
	Setting on the Editor	App4-10
	Communication Error	App4-11
Appendix 4.4	Multi-link	App4-12
	Wiring Diagrams	App4-13
	Setting on the Editor	App4-14
	TS Series Setting	App4-15

Appendix 5 Ladder Transfer Function

Overview	App5-1
Operating Environment	App5-2
Settings	App5-3
V-SFT Setting	App5-3
LadderComOp Setting	App5-5
PLC Programming Software Setting	App5-15
Notes	App5-16

Connection Compatibility List

1. Overview

- 1.1 8-way Communication
- 1.2 Connection Modes
- 1.3 Physical Ports
- 1.4 Wiring
- 1.5 Settings for the Connected Device

1.1 8-way Communication

1.1.1 Overview

The TS series is equipped with six physical ports consisting of three serial ports, one LAN port, one USB-A port, and one USB-miniB port. The LAN port can open eight ports simultaneously. Through these ports, the TS series can be connected to a maximum of eight different models of devices and communicate with them at the same time. Communicating in this manner is called 8-way communication.

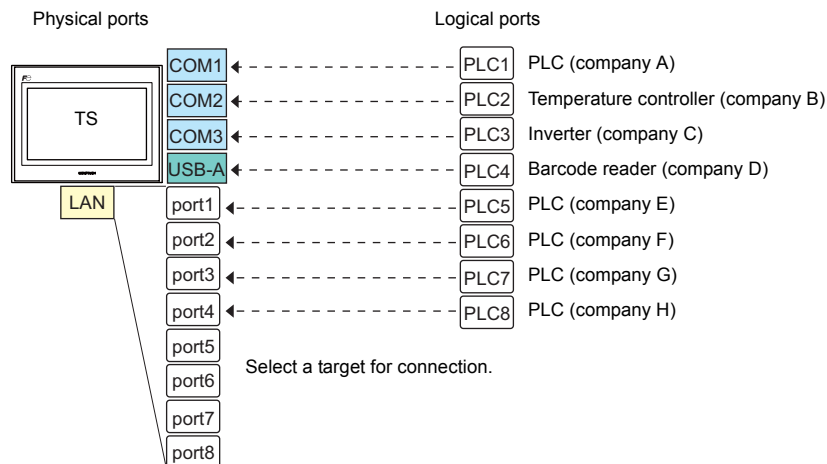

Physical Ports		Number of Ports	Applicable Devices		Remarks
			8-way Communication	Other than 8-way	
Serial	COM1	1	PLC/temperature controller/servo/inverter/V-Link/slave communication (Modbus RTU)	-	
	COM2	1	PLC/temperature controller/servo/inverter/barcode reader/V-Link/slave communication (Modbus RTU)	Serial printer	The same connector used for COM2 and COM3
	COM3	1	PLC/temperature controller/servo/inverter/V-Link/slave communication (Modbus RTU)	-	
Ethernet	LAN	8	PLC/slave communication (Modbus TCP/IP)	-	TSi series only
USB	USB-A	1	Barcode reader	Printer (EPSON STYLUS PHOTO series)/USB memory/USB-CFREC/keyboard/mouse/USB hub	
	USB-miniB	1	-	Printer (PictBridge)/computer (screen data transfer)	

- Only the logical port PLC1 can be selected for the following devices and functions. Thus, they cannot be connected at the same time.
 - Devices
Without PLC connection, Allen-Bradley Control Logix, Siemens S7-200PPI, Siemens S7-300/400 MPI connection
 - Functions
Multi-link2, multi-link, ladder transfer, ladder monitor, Micrex SX variable name cooperation function

1.1.2 System Composition

Serial Communication

The TS series is allowed to communicate with three different models of devices at the same time via three serial ports. A maximum of 31 units of the same model can be connected to the COM1/COM3 port.

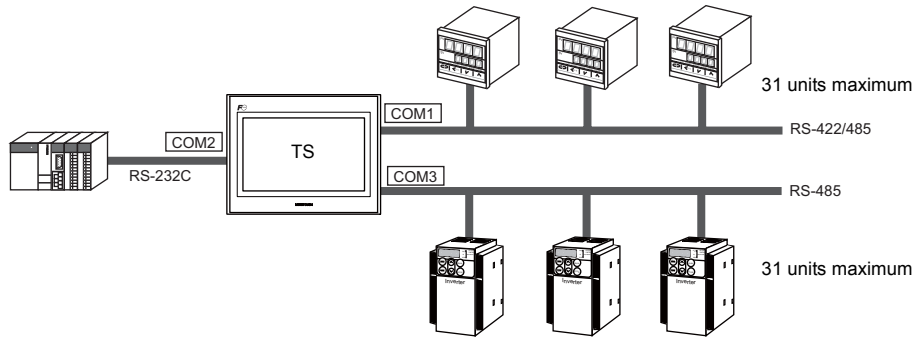

Ethernet Communication

Because eight communication ports can be opened, the TS series is allowed to communicate with eight models of PLCs at the same time.

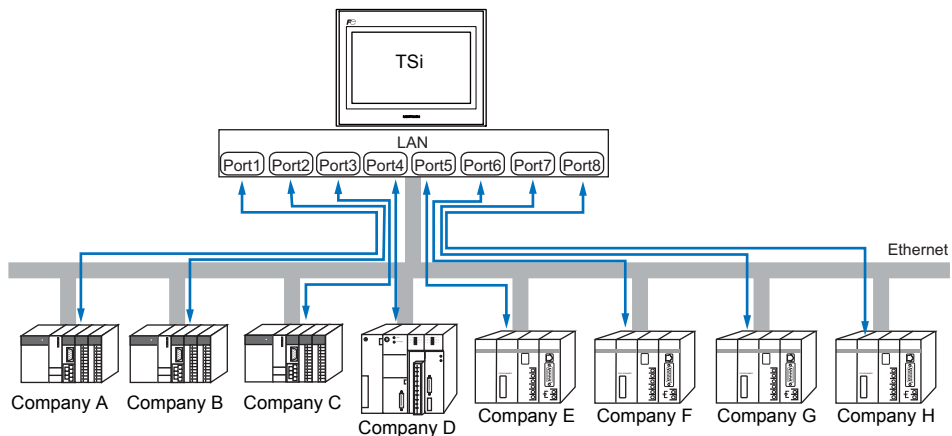

When there are two or more PLCs of the same model, the TS series is allowed to carry out 1 : n communication via one port.

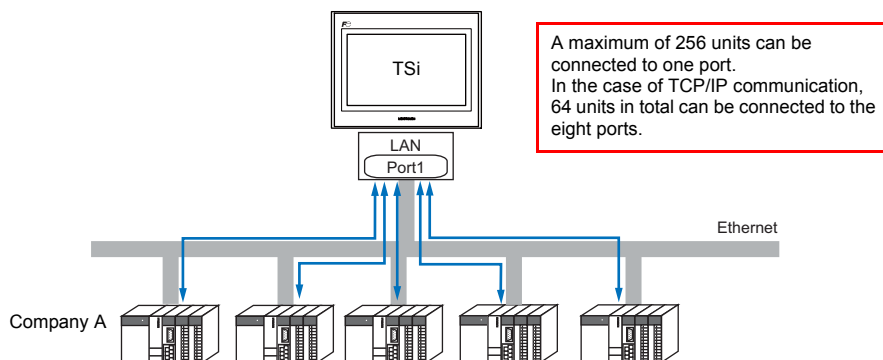

Mixed Serial-Ethernet Communication

In the case of mixed serial-Ethernet communication, the TS series is allowed to communicate with eight different models of devices at the same time.

- Connection of 3 models for serial communication and 5 models for Ethernet communication

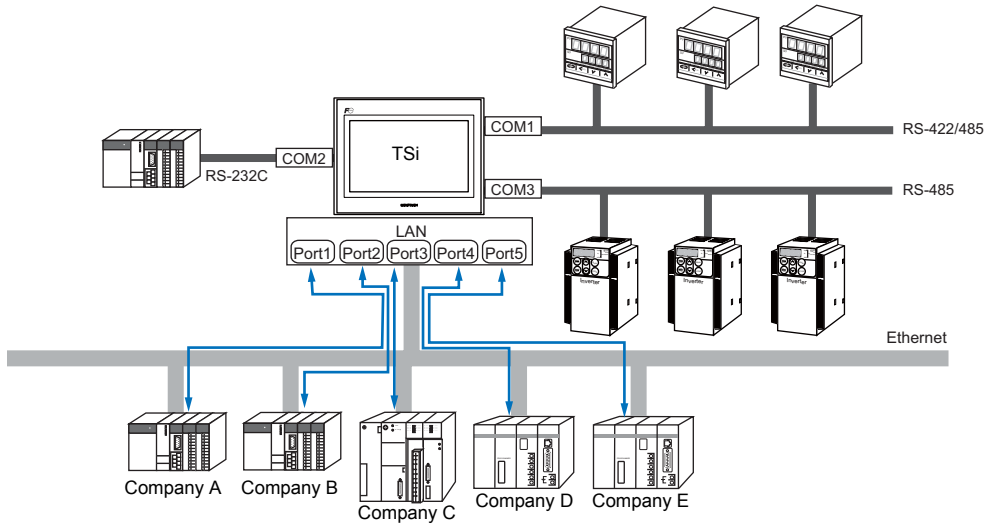

1.2 Connection Modes

1.2.1 PLC Connection

The TS unit(s) can communicate with PLC(s) in serial, Ethernet, or network communication.

Serial Communication

There are six connection modes below to establish serial communication.

1 : 1 Connection

Overview

- One set of the TS is connected to one PLC (1 : 1 connection).
- You can make settings for 1 : 1 communication in the [Communication Setting] tab window for the logical ports PLC1 - PLC8. A communication port is selectable from COM1, COM2, and COM3.

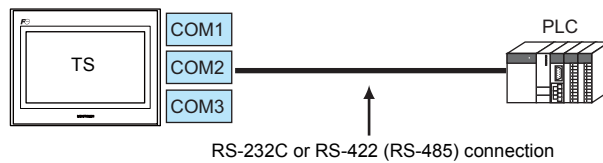

- The TS (master station) communicates with a PLC under the PLC's protocol. Therefore, there is no need to prepare a communication program for the PLC (slave station).
- The TS reads the PLC memory for screen display. It is also possible to write switch data or numerical data entered through the keypad directly to the PLC memory.

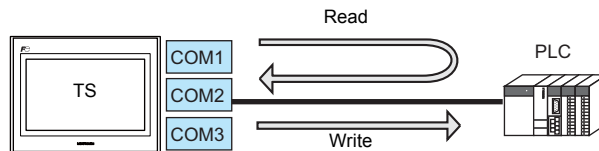

Connection

For more information on connection, see "1.4 Wiring" on page 1-18, "1.5 Settings for the Connected Device" on page 1-24, or the chapters on individual manufacturers.

1 : n Connection (Multi-drop)

Overview

- Multi-drop connection connects one TS unit to multiple PLCs of the same model as 1 : n connection. (Maximum connectable PLCs: 31)
- You can make settings for 1:n communication in the [Communication Setting] tab window for the logical ports PLC1 - PLC8. Select either COM1 or COM3 as the communication port. Note that COM1 supports only RS-422 (4-wire system) connection.

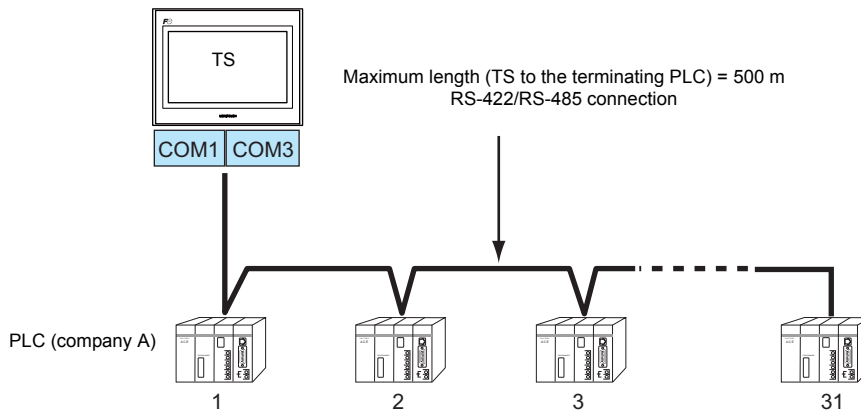

- For models that support multi-drop connection, refer to the list provided at the end of this manual or the chapters on individual manufacturers.

Connection

For more information on connection, see "1.4 Wiring" on page 1-18, "1.5 Settings for the Connected Device" on page 1-24, or the chapters on individual manufacturers.

For description of connecting the PLCs, refer to the manual for the corresponding PLC model.

n : 1 Connection (Multi-link2)

Overview

- One PLC is connected to a maximum of four TS units.
- Multi-link2 enables you to establish an original network consisting of a master TS of local port No. 1 and slave TS units of local port Nos. 2, 3, and 4. The master TS communicates with the PLC directly, and the slave TS units communicate with the PLC through the master.
- Connection example

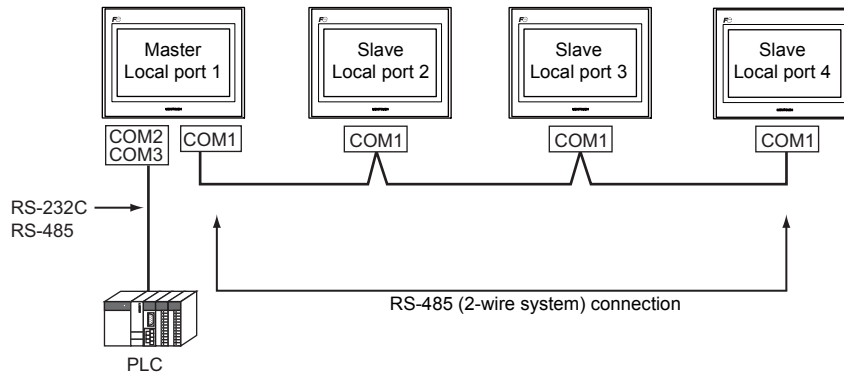

- The [Communication Setting] tab window for the logical port PLC1 is used for multi-link2 settings. Therefore, if [Communication Setting] for PLC1 is already set for a device available as PLC1 only, multi-link2 is disabled.
- Select either COM1 or COM3 as the port for communication among TS units.
- Multi-link2 enables PLC1 memory data to be shared among the TS units. However, sharing data of PLC2 - PLC8 is not possible.
- V7 and V6 cannot be concurrently used with the TS series. However, S8 and V8 can be used with the TS series.
 - * The V7 and V6 series can be connected together with some PLC models. For more information on the available PLC models, refer to page App4-5.
- The communication speed between the master station and the PLC depend on the setting made on the PLC. The maximum communication speed between TS units is 115 kbps, which is higher than the one available with multi-link connection described in "n : 1 Connection (Multi-link)".
- For PLCs that support multi-link2 connection, refer to the list provided at the end of this manual or the chapters on individual manufacturers.

How to connect a master TS and a PLC is the same as the method of 1 : 1 connection.
RS-485 (2-wire system) connection is adopted to connect a master with slaves.

Connection

For more information, see "Appendix 4.1 Multi-link2".

n : 1 Connection (Multi-link2 (Ethernet))

Overview

- One PLC is connected to a maximum of 32 units of the TS series.
- Multi-link2 (Ethernet) enables you to establish an original network consisting of a master TS of local port No. 1 and slave TS units of local port Nos. 2 to 32. The master TS communicates with the PLC directly, and the slave TS units communicate with the PLC through the master.
 - Connection example

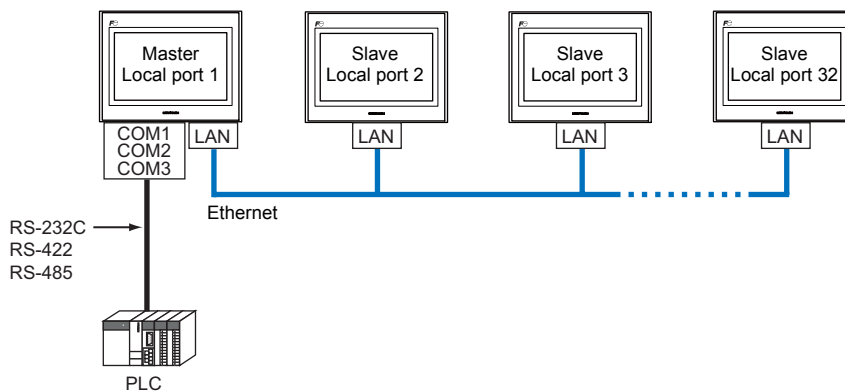

- You can make settings for multi-link2 (Ethernet) in the [Communication Setting] tab window for PLC1.
- Multi-link2 (Ethernet) enables PLC1 memory data to be shared among the TS units. However, sharing data of PLC2 - PLC8 is not possible.
- S8, V7, and V6 cannot be concurrently used with the TS series. However, V8 can be used with the TS series.
- The communication speed between the master station and the PLC depends on the setting made on the PLC; however, communication among TS units is performed via Ethernet, thus, high-speed communication is possible among them.
- For PLCs that support multi-link2 (Ethernet) connection, see the list provided at the end of this manual. The method for connecting a master TS and a PLC is the same as that for 1 : 1 connection. Ethernet connection is adopted to connect a master with slaves.

Connection

For more information, see "Appendix 4.2 Multi-link2 (Ethernet)".

n : n Connection (1 : n Multi-link2 (Ethernet))

Overview

- A maximum of 32 units of the TS series can be connected to a maximum of 31 units of PLCs.
- 1 : n multi-link2 (Ethernet) enables you to establish an original network consisting of a master TS of local port No. 1 and slave TS units of local port Nos. 2 to 32. The master TS communicates with the PLC directly, and the slave TS units communicate with the PLC through the master.

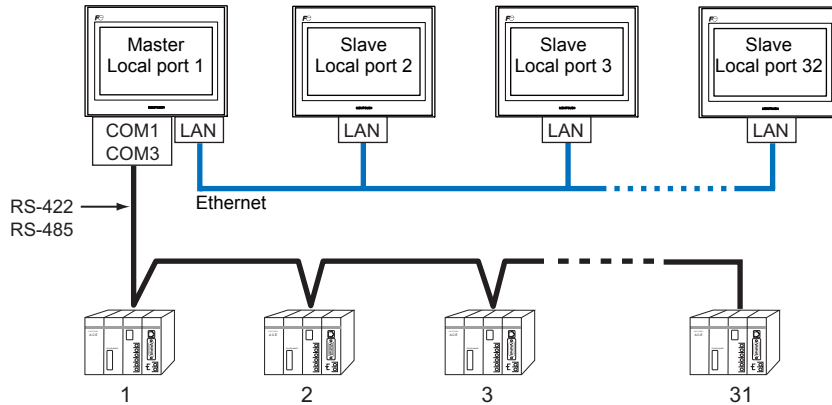

- You can make settings for 1 : n multi-link2 (Ethernet) in the [Communication Setting] tab window for PLC1.
- 1 : n multi-link2 (Ethernet) enables PLC1 memory data to be shared among the TS units. However, sharing data of PLC2 - PLC8 is not possible.
- S8, V7, and V6 cannot be concurrently used with the TS series. However, V8 can be used with the TS series.
- The communication speed between the master station and the PLC depends on the setting made on the PLC; however, communication among TS units is performed via Ethernet, thus, high-speed communication is possible among them.
- For PLCs that support 1 : n multi-link2 (Ethernet) connection, see the list provided at the end of this manual. The method for connecting a master TS and a PLC is the same as that for 1 : n connection. Ethernet connection is adopted to connect a master with slaves.

Connection

For more information, see "Appendix 4.3 1 : n Multi-link2 (Ethernet)".

n : 1 Connection (Multi-link)

Overview

- One PLC is connected to a maximum of 31 TS units. The S8, V8, V7, and V6 series can be used together.
 - Connection Example

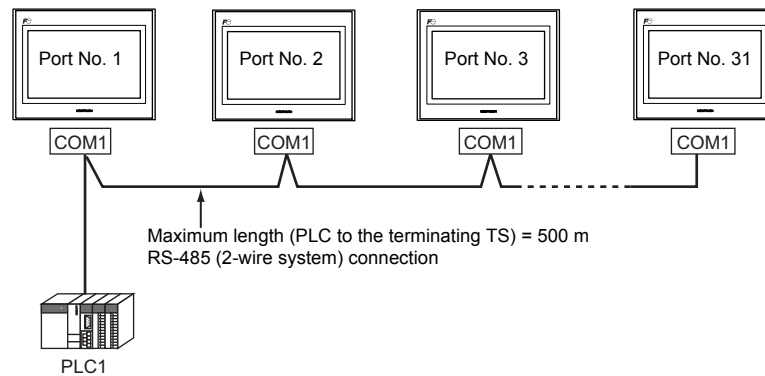

- You can make settings for multi-link using the logical port PLC1. For the TS, a communication port is selectable from COM1, COM2, and COM3. Use COM1 for S8, and CN1 for V8, V7, or V6.
- Only a PLC for the signal level RS422/RS485 and with a port number is available. For PLCs that support multi-link connection, refer to the list provided at the end of this manual or the chapters on individual manufacturers.
- RS-485 (2-wire system) connection is adopted to connect a TS-series unit and a PLC.

Connection

For more information, see "Appendix 4.4 Multi-link".

Ethernet Communication

Overview

- Because eight communication ports can be opened, the TS series is allowed to communicate with eight models of PLCs at the same time.

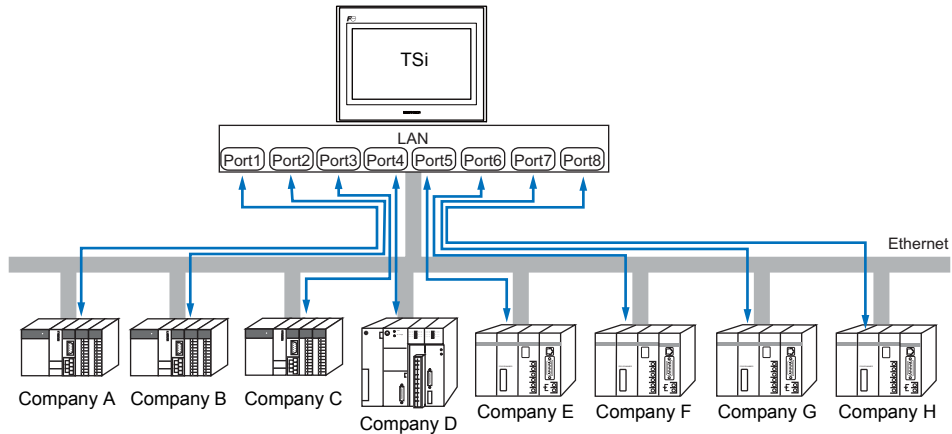

- When there are two or more PLCs of the same model, the TSi series is allowed to carry out 1 : n communication via one port.

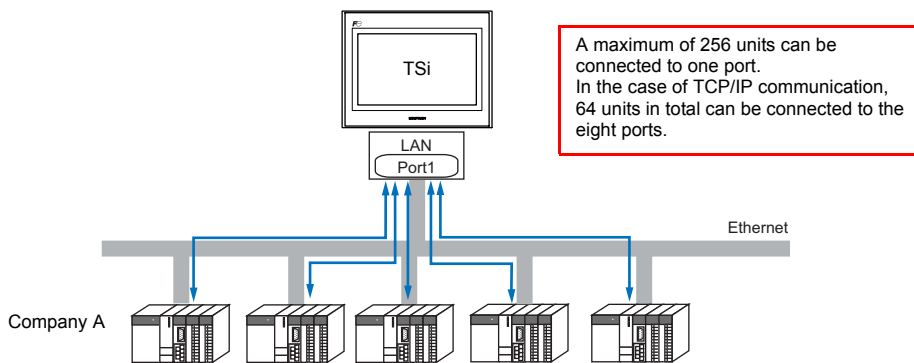

- If multiple TS units are connected to one single PLC, the maximum permissible number of these units depends on the PLC specifications. Refer to the PLC manual issued by the manufacturer.

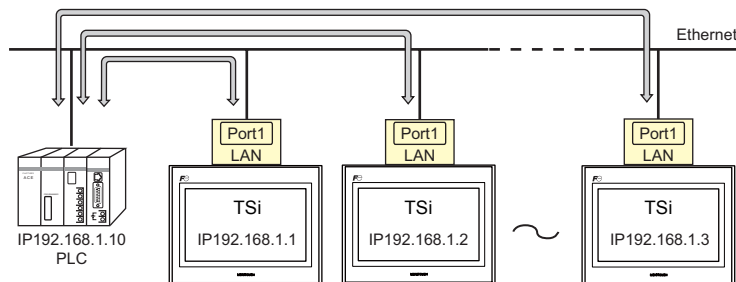

- You can make settings for Ethernet communication in the [Communication Setting] tab window for the logical ports PLC1 - PLC8.

Connection

For more information, see "Appendix 2 Ethernet".

1.2.2 Temperature Controller/Servo/Inverter Connection

The TS series is connected to temperature controllers, servos, or inverters via serial communication.

Serial Communication

1 : n Connection

Overview

- The TS series is connected to multiple temperature controllers, servos, or inverters of the same model as 1 : n connection. (Maximum connectable units: 31)
- For temperature controller/servo/inverter communication settings, go to the [Communication Setting] tab window for the logical ports PLC1 - PLC8. Select either COM1 or COM3 as the communication port. Note that only COM1 supports RS-422 (4-wire system) connection.

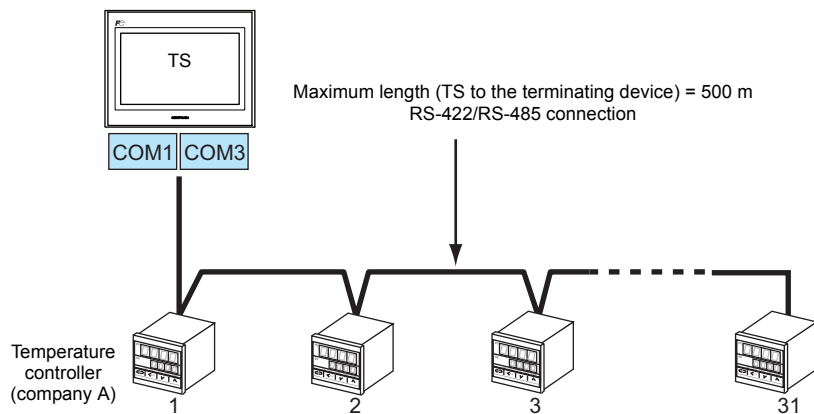

Connection

For more information on connection, see "1.4 Wiring" on page 1-18, "1.5 Settings for the Connected Device" on page 1-24, or the chapters on individual manufacturers.

1.2.3 Barcode Reader Connection

A barcode reader is connected to either port for serial or USB communication.

Serial Communication

Overview

- The TS series is connected to a barcode reader as 1 : 1 connection (RS-232C).
- For barcode reader communication settings, go to the [Communication Setting] tab window for a logical port PLC2 to PLC8. Use COM2 as the communication port.

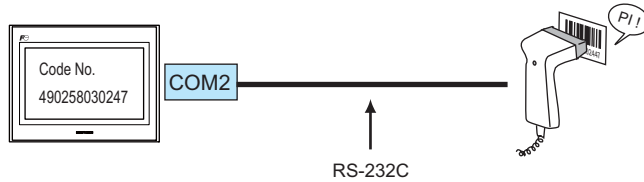

Connection

For more information on connection, see “58.1 Barcode Reader Connection”.

USB Communication

Overview

- Connect the TS unit with a barcode reader in the form of 1 : 1 (USB) connection.
- For barcode reader communication settings, go to the [Communication Setting] tab window for a logical port PLC2 to PLC8. Use USB-A as the communication port.



Connection

For more information on connection, see “58.1 Barcode Reader Connection”.

1.2.4 Slave Communication

Connecting via V-Link, Modbus RTU, or Modbus TCP/IP is applicable to slave communication using the TS. V-Link and Modbus RTU are used for serial communication, and Modbus TCP/IP is used for Ethernet (TCP/IP) communication.

V-Link

- “V-Link” is the network where the computer reads from and writes to the internal memory of the TS series, memory card, or PLC1 to 8 memory using a dedicated protocol.

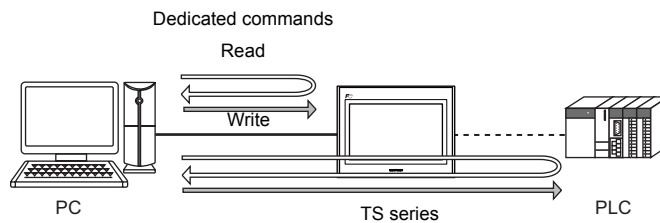

- You can make settings for V-Link in the [Communication Setting] tab window for the logical ports PLC2 - PLC8. A communication port is selectable from COM1, COM2, and COM3.
- For more information, see “59.1 V-Link”.

Modbus RTU

- The TS series is connected to a Modbus RTU master via serial connection.
- The Modbus slave communication memory table is prepared for the TS. The master is allowed to gain access to the memory table and read/write the PLC data.
- For more information, refer to the Modbus Slave Communication manual separately provided.

Modbus TCP/IP

- The TS is connected to a Modbus TCP/IP master via Ethernet communication.
- The Modbus slave communication memory table is prepared for the TS. The master is allowed to gain access to the memory table and read/write the PLC data.
- For more information, refer to the Modbus Slave Communication manual separately provided.

1.2.5 Other Connections

Use the serial port COM2 for connection with a serial printer.
For any other communications than 8-way, use the USB port.

1.3 Physical Ports

1.3.1 COM1

This connector is used to connect controllers via RS-422 (4-wire system) or RS-485 (2-wire system).

Use DIP switches 2 and 3 to switch between RS-422 (4-wire system) and RS-485 (2-wire system). Sliding the DIP switches to ON connects +RD with +SD (pins 1 and 4) and -RD with -SD (pins 2 and 3) in the TS unit. For more information on DIP switches, see "1.4.5 DIP Switch (DIPSW) Setting" (page 1-23).

- RS-422 (4-wire system): DIP switches 2 and 3 OFF
- RS-485 (2-wire system): DIP switches 2 and 3 ON

Pin Arrangement

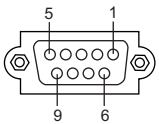
COM1 Dsub 9pin, Female	Pin No.	Signal	RS-422/ RS-485
	SHELL	FG	Frame ground
	1	+RD	Receive data (+)
	2	-RD	Receive data (-)
	3	-SD	Send data (-)
	4	+SD	Send data (+)
	5	SG	Signal ground
	6	NC	Not used
	7	NC	Not used
	8	NC	Not used
9	NC	Not used	

Recommended Connector for Communication Cable

Recommended Connector	
DDK's 17JE-23090-02(D8C)-CG	D-sub 9-pin, male, inch screw thread (#4-40UNC), with hood, lead and cadmium-free type

Applicable Devices

Applicable Devices
PLC, temperature controller, inverter, servo, V-Link, slave communication (Modbus RTU)

1.3.2 COM2/COM3

This connector is used to connect controllers via RS-232C or RS-485 (2-wire system). Communications via RS-232C (COM2) and RS-485 (COM3) can take place at the same time.

Pin Arrangement

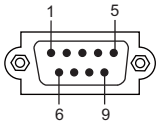
COM2/COM3 D-sub 9-pin, Male	Pin No.	RS-232C(COM2)		RS-485(COM3)	
		Signal	Contents	Signal	Contents
	SHELL	FG	Frame ground	FG	Frame ground
	1	-	-	-SD/RD	Send/receive data (-)
	2	RD	Receive data	-	-
	3	SD	Send data	-	-
	4	NC	Not used	-	-
	5	SG	Signal ground	-	-
	6	-	-	+SD/RD	Send/receive data (+)
	7	RTS	Request to send	-	-
	8	CTS	Permission to send	-	-
9	-	-	SG	Signal ground	

Recommended Connector for Communication Cable

Recommended Connector	
DDK's 17JE-23090-02(D8C)A-CG	D-sub 9-pin, female, inch screw thread (#4-40UNC), with hood, lead and cadmium-free type

Applicable Devices

Applicable Devices
PLC, temperature controller, inverter, servo, barcode reader, V-Link, slave communication (Modbus RTU)

1.3.3 LAN

LAN Port Specifications

Item	Specifications	
	100BASE-TX (IEEE802.3u)	10BASE-T (IEEE802.3)
Baud Rate	100 Mbps	10 Mbps
Transmission Method	Base band	
Maximum Segment Length	100 m (between the node and the hub)	
Connecting Cable	100 Ω, UTP cable, category 5	
Protocol	UDP/IP, TCP/IP *1	
Port	Auto-MDIX function compatible	
Number of concurrently opened ports*2	8 ports	
Maximum number of connectable devices*2	256 sets each via one single port PLC1 - PLC8	
Maximum number of connectable devices (TCP/IP)*2	64 sets in total via PLC1 - PLC8	

*1 For connection with some PLCs
 *2 See the figure shown below.

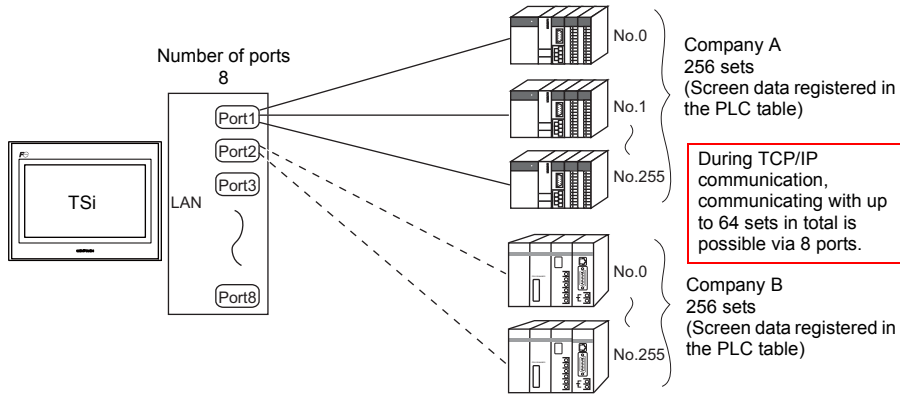

Pin Arrangement

LAN RJ45	Pin No.	Signal	Contents
	1	TX+	Ethernet send signal (+)
	2	TX-	Ethernet send signal (-)
	3	RX+	Ethernet receive signal (+)
	4	NC	Not used
	5		
	6	RX-	Ethernet receive signal (-)
	7	NC	Not used
	8		

LED



LAN RJ45	LED		Contents
	Green	Orange	
	ON	ON	100BASE-TX
	ON	OFF	10BASE-T
	Blinking	ON/OFF	Sending/receiving data

Applicable Devices

Applicable Devices
PLC, slave communication (Modbus TCP/IP), computer (screen data transfer, V-Server, etc.)

1.3.4 USB

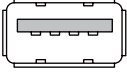
USB Port Specifications

Item		Specifications
USB-A 	Applicable Standards	USB versions 2.0 and 1.1
USB-miniB 	Baud Rate	Version 1.1: Low-speed 1.5 Mbps, full-speed 12 Mbps Version 2.0: High-speed 480 Mbps

Applicable Devices

Port	Applicable Devices
USB-A	Printer (EPSON STYLUS PHOTO series), barcode reader, USB memory, USB-CFREX, keyboard, mouse, USB hub
USB-miniB	Printer (PictBridge), computer (screen data transfer)

1.4 Wiring

This section provides notes on configuring cables. For device wiring diagrams, refer to the chapters on individual manufacturers.



DANGER

Be sure to turn off the power before connecting cables. Otherwise, electrical shock or damage may occur.

1.4.1 COM1 Connection

Use DIP switches 2 and 3 to switch between RS-422 and RS-485.

Sliding the DIP switches to ON connects +RD with +SD (pins 1 and 4) and -RD with -SD (pins 2 and 3) in the TS unit. For more information on DIP switches, see "1.4.5 DIP Switch (DIPSW) Setting" (page 1-23).

- RS-422 (4-wire system): DIP switches 2 and 3 OFF
- RS-485 (2-wire system): DIP switches 2 and 3 ON

RS-422/485 Connection

- Prepare a communication cable on your side. Twisted pairs of 0.3 mm sq. or above are recommended.
 - Connect +SD with -SD and +RD with -RD as pairs respectively.
 - If the PLC has the terminal for signal ground (SG), connect a wire.
 - To use a terminal block for connection, use Hakko Electronics' "TC-D9" optionally available.
 - DIP switches on the back of the TS unit are used to set the terminating resistance. For more information, see "1.4.5 DIP Switch (DIPSW) Setting" (page 1-23).
 - Connect a shielded cable to either the TS series or the connected device. The connection diagram shows the case where the shielded cable is connected to the TS series. When connecting to the TS series, connect a shielded cable to the D-sub 9-pin connector's shell.
- RS-422 (4-wire system)

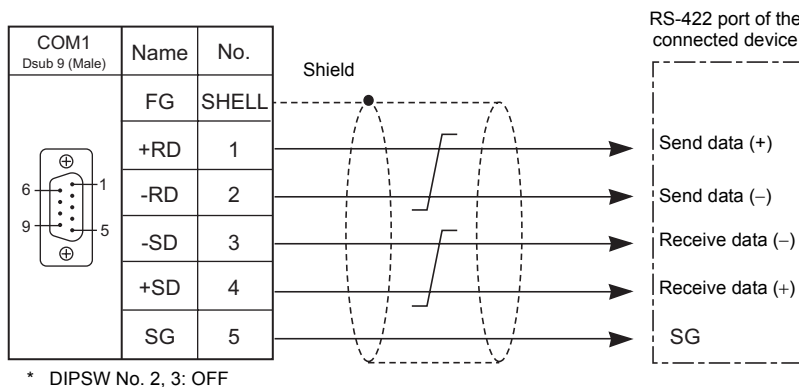

- RS-485 (2-wire system)

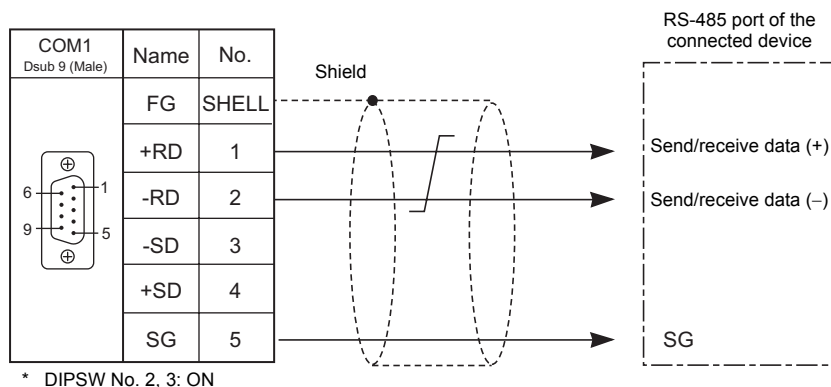

- If noise disturbs communications, connect a shielded cable to both the TS series and the connected device.
 - RS-422 (4-wire system)

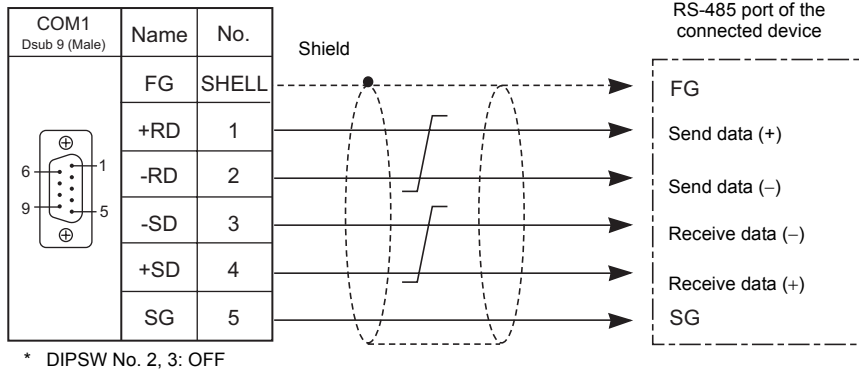

- RS-485 (2-wire system)

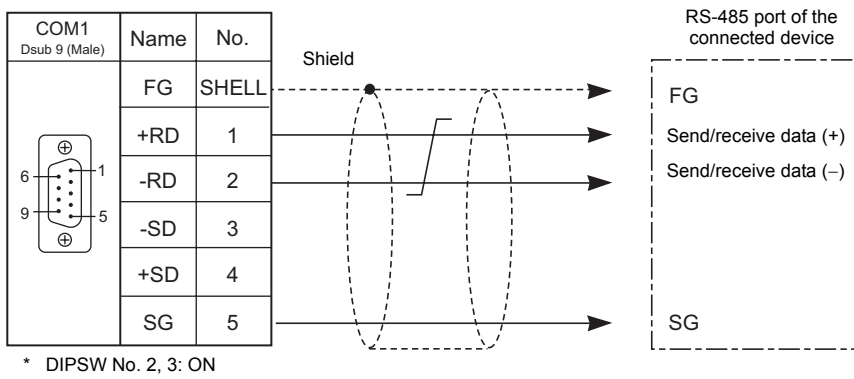

Multi-drop connection (1 : n)

In the case of multi-drop connection, wiring between a TS unit and a connected device is the same as installed for 1 : 1 communication. Meanwhile, for description of wiring between connected devices, refer to the manual issued by the manufacturer.

- Connection example

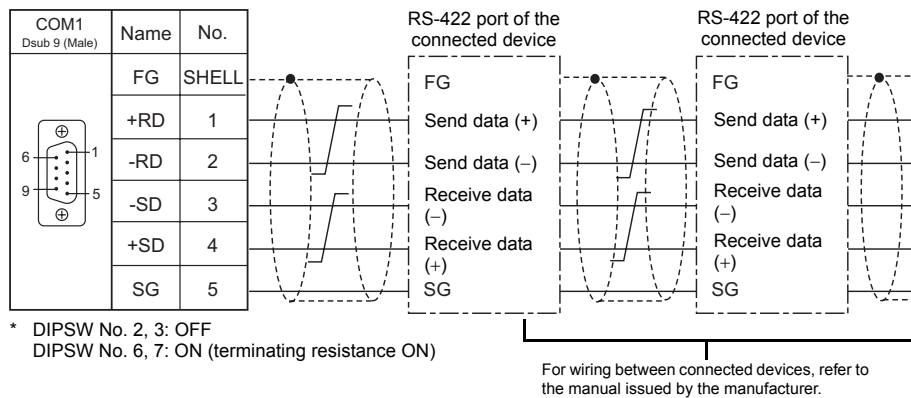

1.4.2 COM2 Connection

RS-232C Connection

- Prepare a communication cable on your side. Twisted pairs of 0.3 mm sq. or above are recommended.
- Connect a shielded cable to either the TS series or the connected device. The connection diagram shows the case where the shielded cable is connected to the TS series. When connecting to the TS series, connect a shielded cable to the D-sub 9-pin connector's shell.

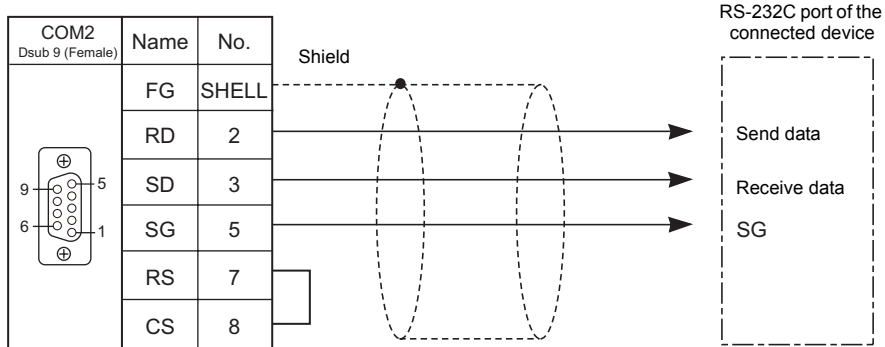

- If noise disturbs communications, connect SD with SG and RD with SG as pairs respectively, and connect a shielded cable to both the TS series and the connected device.

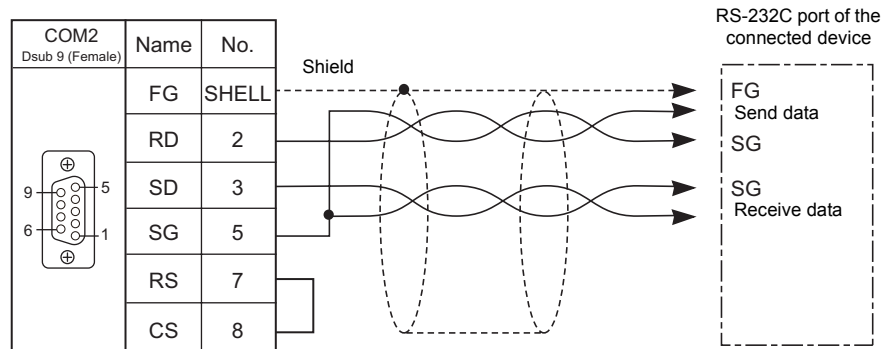

1.4.3 COM3 Connection

RS-485 Connection

- Prepare a communication cable on your side. Twisted pairs of 0.3 mm sq. or above are recommended.
- DIP switches on the back of the TS unit are used to set the terminating resistance. For more information, see "1.4.5 DIP Switch (DIPSW) Setting" (page 1-23).
- Connect a shielded cable to either the TS series or the connected device. The connection diagram shows the case where the shielded cable is connected to the TS series. When connecting to the TS series, connect a shielded cable to the D-sub 9-pin connector's shell.

- RS-485 (2-wire system)

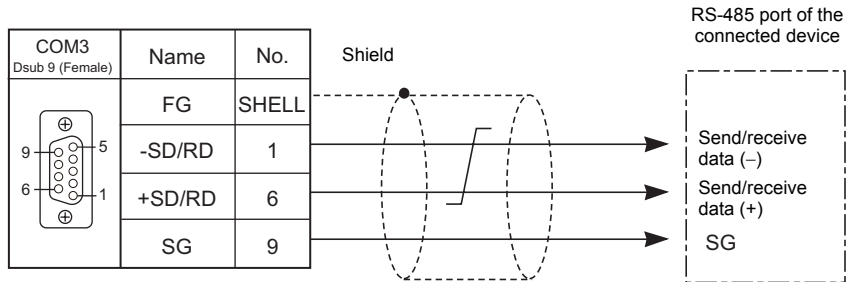

- If noise disturbs communications, connect a shielded cable to both the TS series and the connected device.

- RS-485 (2-wire system)

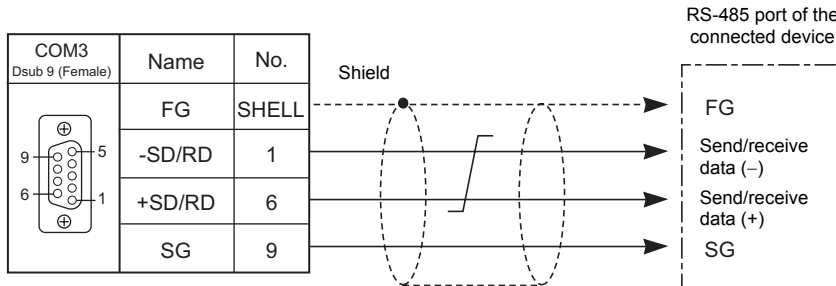

Multi-drop connection (1 : n)

In the case of multi-drop connection, wiring between a TS unit and a connected device is the same as installed for 1 : 1 communication. Meanwhile, for description of wiring between connected devices, refer to the manual issued by the manufacturer.

- Connection example

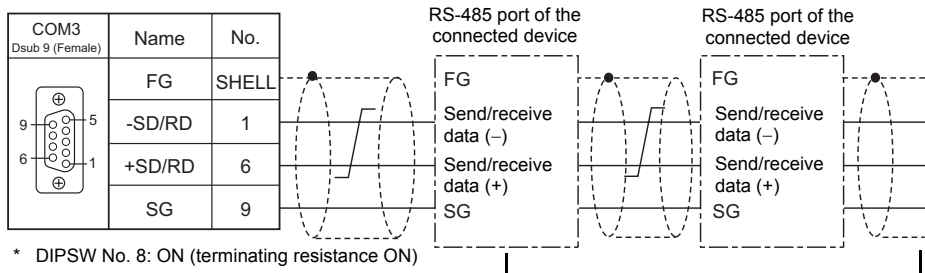

* DIPSW No. 8: ON (terminating resistance ON)

For wiring between connected devices, refer to the manual issued by the manufacturer.

1.4.4 LAN

Connection Example

With hub

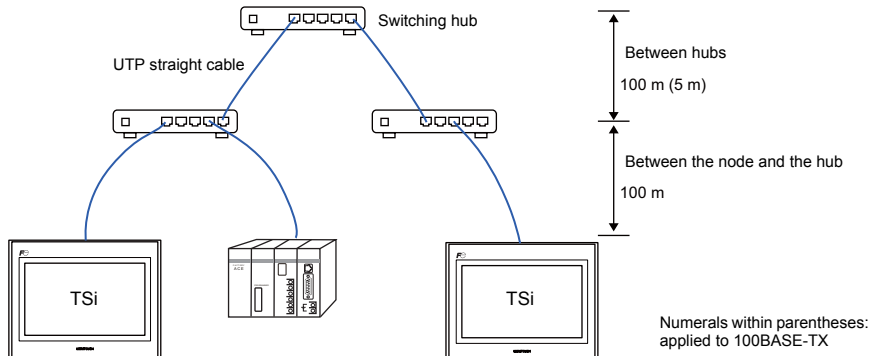

Without hub

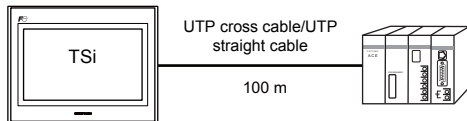

* Both cross cables and straight cables can be used.

Wiring Diagrams

- Use a commercially available cable. Using a self-made cable may cause an error in network connection.

- Straight cable

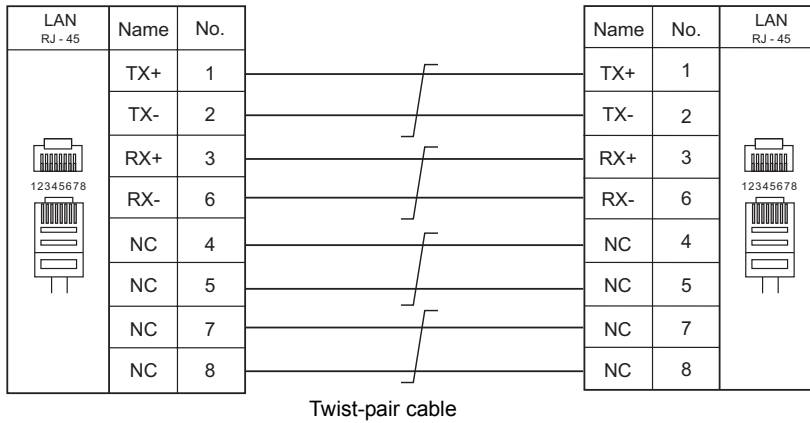

- Cross cable

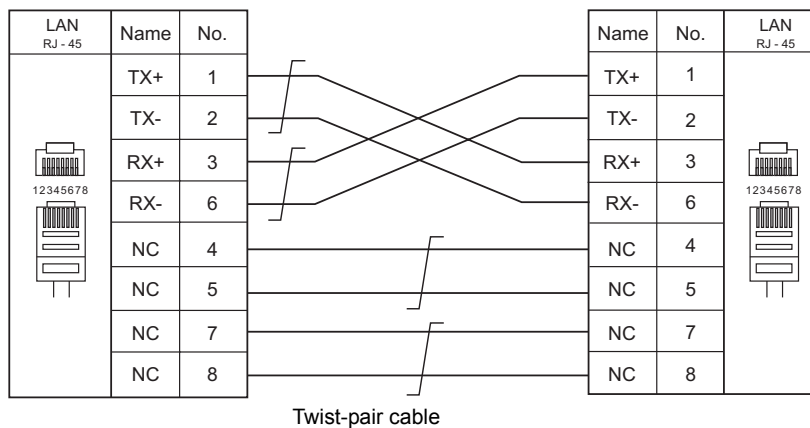

1.4.5 DIP Switch (DIPSW) Setting

DIP switches 1 to 8 are mounted. Turn off the power when setting DIP switches. All the DIP switches are factory-set to OFF before shipment.

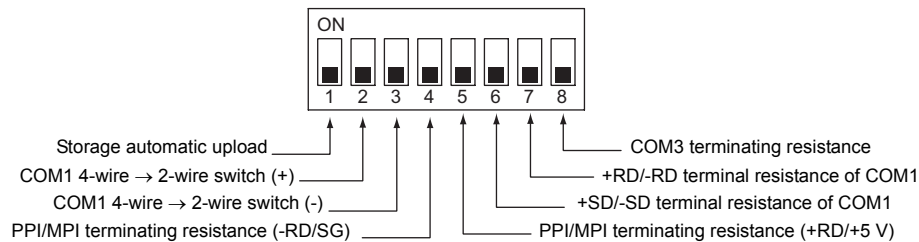

DIPSW1* (Storage automatic upload)

Set this DIP switch to ON when automatically uploading screen data from the storage such as USB memory. For more information, refer to the TS Series Hardware Specifications manual.

* Set the DIPSW1 to OFF whenever automatic upload is not performed.

DIPSW2 and DIPSW3 (COM1 4-wire → 2-wire switch)

Setting these DIP switches to ON connects +RD with +SD (pins 1 and 4) and -RD with -SD (pins 2 and 3) in the TS unit.

- Set the DIPSW2 and 3 to ON when connecting a controller to COM1 via RS-422/485 (2-wire system).
- Set DIPSW2 and 3 to OFF when connecting a controller to COM1 via RS-422/485 (4-wire system).

DIPSW4 and DIPSW5 (PPI/MPI terminating resistance setting)

Set DIPSW4 and 5 to ON when connecting a Siemens PLC (PPI/MPI) to COM1.

DIPSW6, DIPSW7, and DIPSW8 (terminating resistance setting)

- Set DIPSW7 to ON when connecting a controller to COM1 via RS-422/485 (2-wire system).
- Set DIPSW6 and 7 to ON when connecting a controller to COM1 via RS-422/485 (4-wire system).
- Set DIPSW8 to ON when connecting a controller to COM3 via RS-422/485 (2-wire system).

1.5 Settings for the Connected Device

1.5.1 PLC1 to PLC8

To enable communication with a PLC, a temperature controller, an inverter, etc., the following settings are required to be set on the editor. You can see the contents of these settings on the TS Main Menu screen.

For the Main Menu screen, refer to the separate TS Series Hardware Specifications manual.

Selecting a Device to be Connected

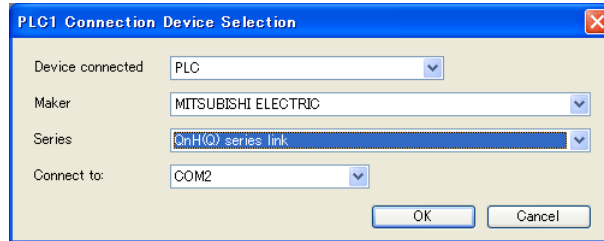

Communication Setting

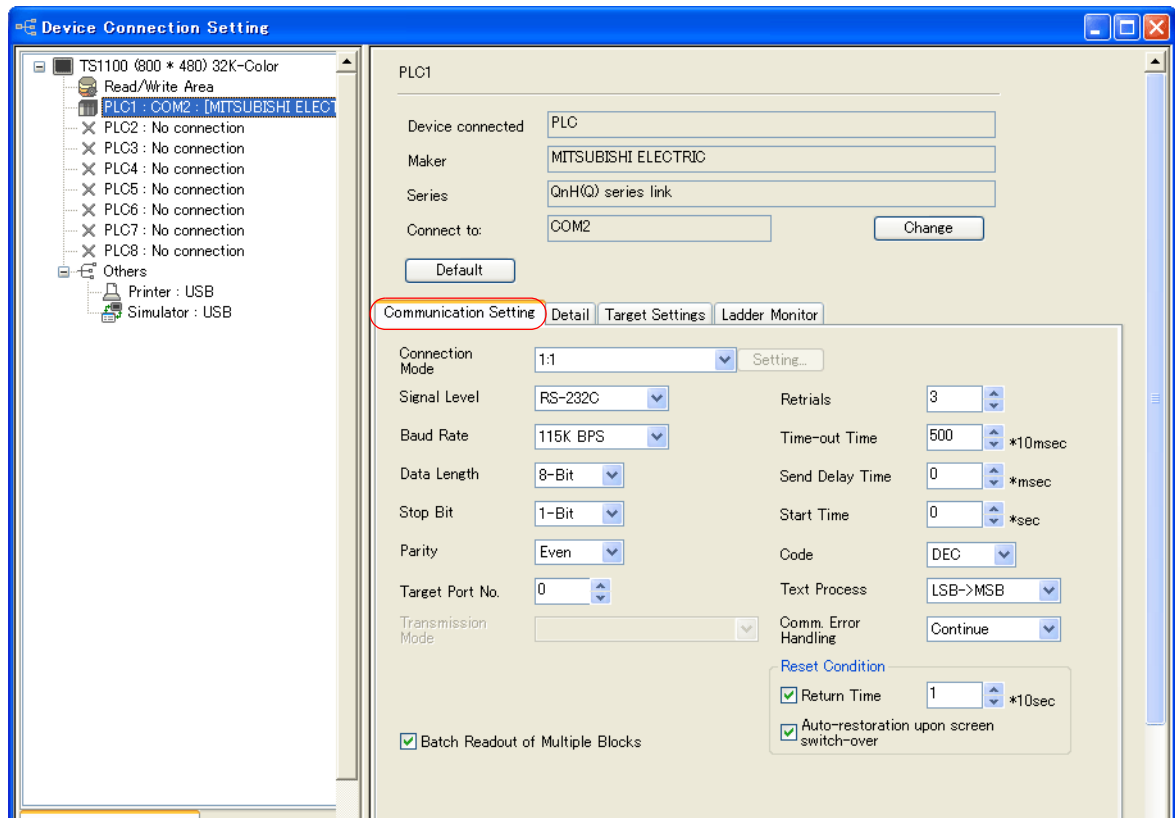

Connection Mode	Select a connection mode. 1 : 1 / 1 : n / Multi-link / Multi-link2 Available options vary, depending on which device is connected. See the list at the end of this manual.
Signal Level ^{*1}	Select a signal level. RS-232C / RS-422/485
Baud Rate ^{*1}	Select a baud rate. 4800 / 9600 / 19200 / 38400 / 57600 / 76800 / 115K / 187.5K ^{*2} bps
Data Length ^{*1}	Select a data length. 7-Bit / 8-Bit
Stop Bit ^{*1}	Select a stop bit. 1-Bit / 2-Bit
Parity ^{*1}	Select an option for parity bit. None / Odd / Even
Target Port No. ^{*1}	Specify a port number of the connected device. 0 to 31 (Modbus RTU: 1 to 255)

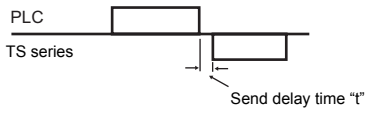
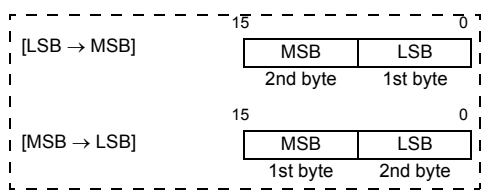
Transmission Mode* ¹	Select a transmission mode for the connected device. This setting is required if a device of Mitsubishi, Omron, Hitachi Industrial Equipment Systems, Yokogawa, JTEKT, or Yaskawa is in use.
Time-out Time	Specify a period of time allowed for TS to monitor a response from its connected device. If TS receives no response within the specified time, it retries to communicate with it. 0 to 999 (× 10 msec)
Retrials	Specify the number of retrials to be allowed in the event of a timeout during communication. If a timeout persists even after as many retrials as specified, an error handling routine will take place. 1 to 255
Send Delay Time	Specify a delay time that elapses before TS sends the next command after receiving a response from its connected device. Normally use the default setting. 0 to 255 (× 1 msec) 
Start Time	Specify a delay time that elapses before TS starts to send commands upon power-up. If TS and its connected device are turned on at the same time and the device is slower to start up, set [Start Time]. 0 to 255 (× 1 sec)
Comm. Error Handling	Select an action to be taken in the event of a communication error. <ul style="list-style-type: none"> [Stop] Communication will be stopped entirely and the communication error screen will be displayed. The [RETRY] switch is available to retry the reestablishment of communication. [Continue] The communication error message will be displayed in the top-left of the screen. The same communication will continue until restoration, and screen operation is not allowed then. When communication has been returned to a normal state, the message disappears and screen operation is allowed. [Disconnect] No error message will appear and communication will proceed to the next.* However, communication with the device, in which a timeout was detected, will be disconnected. * Internal memory must be specified for [Read Area] and [Write Area].
Reset Condition	This setting is valid when [Disconnect] is selected for [Comm. Error Handling]. <ul style="list-style-type: none"> <input type="checkbox"/> Return Time] 1 to 255 sec (× 10 sec) When the specified time has elapsed, TS checks the restoration of the device which discontinued communicating. <input type="checkbox"/> Auto-restoration upon screen switch-over] When the screen is switched, TS checks the restoration of the device which discontinued communicating.
Code	Select a code for the connected device. The selected option is reflected through the data displayed on graphs or trending sampling parts. DEC/BCD
Text Process	Specify a byte order in text data. This setting is valid for macro commands that handle text. LSB → MSB / MSB → LSB 
Port No.	Displayed when models compatible with Ethernet communications are selected under [Device Connection Setting].
KeepAlive	For more information, see "Appendix 2 Ethernet".

*1 Be sure to match the settings to those made on the connected device.

*2 Only when connected with a Siemens device via COM1.

Detail

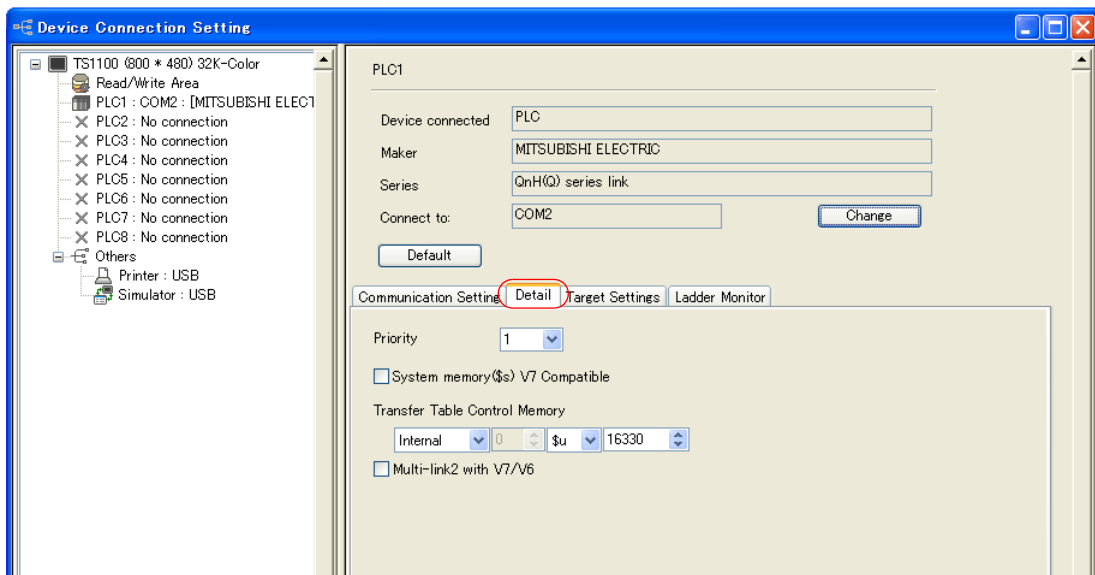

Priority	[1] (higher priority) - [8] (lower priority) Specify a priority taken during 8-way communication. If interrupts from two or more devices occur at the same time, communication with these devices will take place in order of priority.
<input type="checkbox"/> System memory (\$s) V7 Compatible (PLC1)	This box is checked if the V7-series screen data has been converted to the data for the TS series. The system information relevant to 8-way communication will be stored in memory \$P1 and \$s. For more information, see "Appendix 3 System Memory" (page App3-1).
<input type="checkbox"/> System memory (\$s) V7 Compatible (PLC2)	This box is checked if the V7-series screen data (including temperature control network/PLC2Way settings) has been converted to the data for the TS series. <ul style="list-style-type: none"> • Unchecked \$P2:493/494/495 is used as the transfer table control memory. • Checked \$s762/763/764 is used as the transfer table control memory. For more information, see "Appendix 3 System Memory" (page App3-1).
Transfer Table Control Memory	Specify the transfer table control memory for PLC1 - PLC8. The memory specified here is the same as [Control Memory] in the [Device Memory Map Setting] dialog ([System Setting] → [Device Memory Map] → [Device Memory Map Edit] window → [Device Memory Map Setting] dialog). For more information, see "Control Memory" (page App1-11).
<input type="checkbox"/> Multi-link2 with V7/V6	This box is checked when multi-link2 is used for connecting the TS together with the V7 or V6.

Target Settings

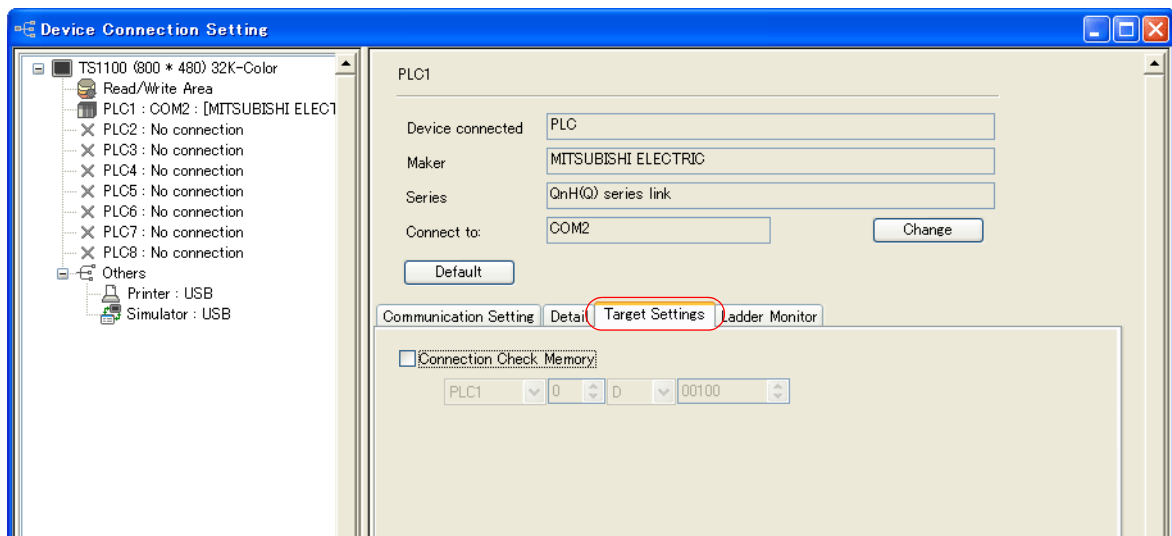

<input type="checkbox"/> Connection Check Memory	Specify a desired memory address used for connection confirmation when communication starts. This memory address will be used mainly during Modbus communication.
Connect To	Set these items for Ethernet communication. See "Appendix 2 Ethernet".
PLC Table	

1.5.2 Read/Write Area

Read/Write Area

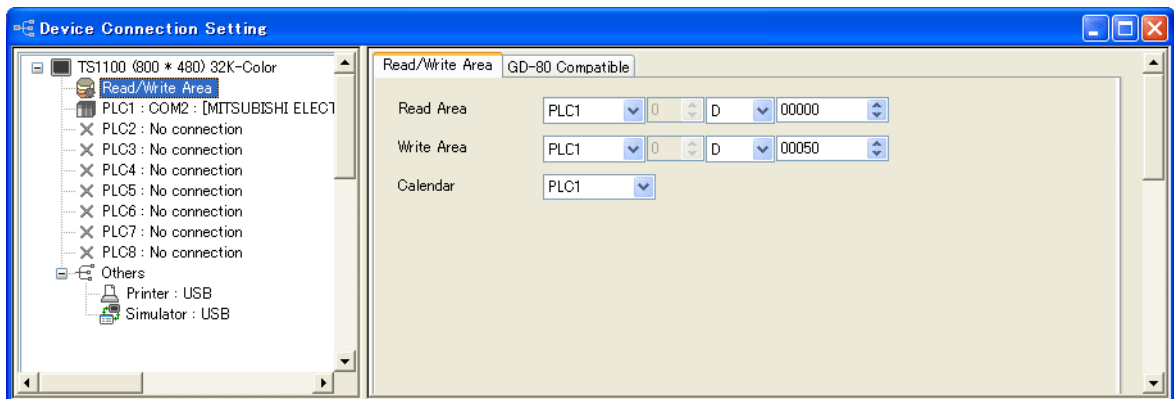

Read Area	Specify a memory address used to give commands for display or operation from the PLC to TS series. Three words (at the minimum) ^{*1} of consecutive memory addresses are secured. For more information, see "Read area" (page 1-27).
Write area	This is the area, to which the screen numbers or overlaps displayed on TS series or a buzzer state will be written. Three words of consecutive memory addresses are secured. For more information, see "Write area" (page 1-31).
Calendar	This setting is valid when the TS's internal clock ^{*2} is not used. The setting allows the calendar data to be read from the device via the selected port at PLC1 - PLC8. The calendar data will be updated when: <ul style="list-style-type: none"> The power is turned on. STOP → RUN The date changes. Bit 11 in the read area "n" is set (ON) (0 → 1 leading edge)

- *1 More words are required if the sampling function is used: sampling control memory (three words maximum), sampling data memory (variable depending on the setting)
- *2 For more information on the internal clock, refer to the V8 Series Reference Manual.

Read area

The read area is the area where the PLC gives commands for display or operation to TS series. Three words (at the minimum) of consecutive memory addresses are secured. TS series always reads data from these three words to display and operate according to the commands.

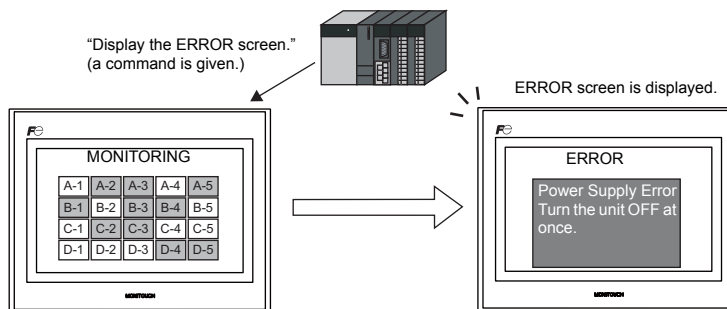

Memory addresses are allocated as shown below.

Address	Contents	Operation
n	Sub command/data	TS series ← PLC
n + 1	Screen status command	
n + 2	Screen number command	

* Data in these memory addresses is saved at \$s460 to 462 of the TS series internal memory. For more information on the internal memory (\$s), refer to the V8 Series Reference Manual.

Read area "n" (sub command/data)															
15	14	13	12	11	10	09	08	07	06	05	04	03	02	01	00
0	0	0	0												
												(1) Free			
												(2) BZ0 [0 → 1] (leading edge)			
												(3) BZ1 [0 → 1] (leading edge)			
												(4) BZ2 [1] (level)			
												(5) Calendar setting ([0 → 1] (leading edge))			
												(6) System reserved			
(1) Free				When data is saved in this area, the same data is written to [Write Area] "n" after the screen has been displayed. Utilizing this operation, these bits can be used for watch dog monitoring ^{*1} or display scanning ^{*2} .											
(2) BZ0				A beep (peep) sounds at the leading edge [0 → 1].											
(3) BZ1				An error buzzer (peep-peep) sounds at the leading edge [0 → 1].											
(4) BZ2				A buzzer (fieee) sounds continuously while the bit remains [1]. When setting this bit, check [Use Continuous Buzzer Sound] ([System Setting] → [Unit Setting] → [General Setting]).											
(5) Calendar setting ^{*3}				This bit is valid when the built-in clock is not used. This bit should be used differently depending on whether the connecting PLC is equipped with the calendar function.											
				When TS series is connected to a PLC with calendar function: When calendar data in the PLC is updated, it can forcibly be read by setting this bit (at the leading edge of [0 → 1]). In addition to calendar data update using this bit, calendar data in the PLC is automatically read and updated when: <ul style="list-style-type: none"> • The power is turned on. • STOP → RUN • The date changes (AM 00:00:00). 											
				When TS series is connected to a PLC without calendar function: A virtual calendar area can be provided by setting [Calendar memory] in the [GD-80 Compatible] tab window ([Read/Write Area] → [GD-80 Compatible]). Then setting this bit (ON) updates the calendar data.											
(6) System reserved				This bit is reserved by the system. This bit must be "0".											

^{*1} Watchdog

When the PLC is communicating with TS series, there is no means for the PLC to know whether or not TS series is doing operations correctly. To solve this one-way communication, change data in bits 0 to 7 in [Read Area] "n" and check that the same data is saved in bits 0 to 7 in [Write Area] "n". This proves that the TS series is correctly doing operations through communications with the PLC. This verification is called "watchdog".

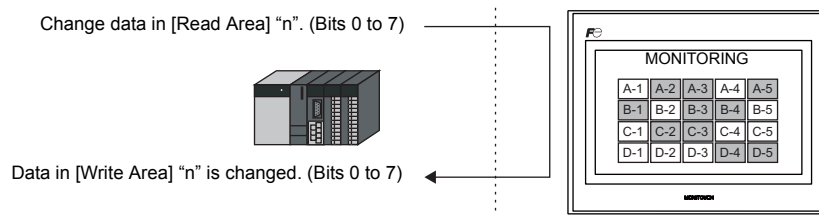

^{*2} Display scanning

This operation can be utilized for display scanning. Change data in bits 0 to 7 in [Read Area] "n" when giving a graphic change command and check that the same data is saved in bits 0 to 7 in [Write Area] "n". This can prove that the graphic change command is received and executed correctly.

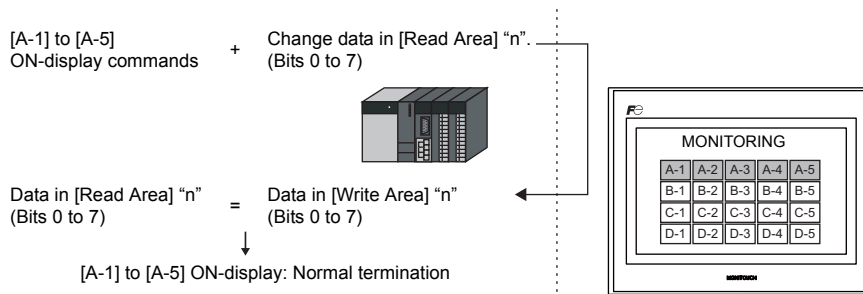

^{*3} If this bit is used during constant sampling, data sampling timing may be shifted. If this bit is set during constant sampling, we recommend you to reset the sampling as well.

Read area "n + 1" (screen status command)															
15	14	13	12	11	10	09	08	07	06	05	04	03	02	01	00
			0					0	0	0	0				
(1) Overlap 0 (2) Overlap 1 (3) Overlap 2	<p>These bits are used for controlling show/hide operations of overlaps.</p> <ul style="list-style-type: none"> • Normal overlap or call-overlap [0 → 1] (leading edge ^{*1}): Show [1 → 0] (falling edge ^{*1}): Hide • Multi-overlap [0] (level ^{*2}): Hide [1] (level ^{*2}): Show It is necessary to specify library No. 0 to 1023 for [Overlap Library Number] for [Multi-Overlap] dialog. 														
(4) Overlap 3	<p>This bit is used for controlling show/hide operations of the global overlap screen. [0 → 1]: Show [1 → 0]: Hide It is necessary to specify library No. 0 to 9999 for [Overlap Library Number] in the [Global Overlap Setting] dialog.</p>														
(5) System reserved	<p>This bit is reserved by the system. This bit must be "0".</p>														
(6) Global macro execution	<p>The macro set for [Macro Block] is executed once at [0 → 1] (leading edge). The macro block number should be specified for [Global Macro Memory] in the dialog that is displayed by selecting [System Setting] → [Macro Setting]. For more information, refer to the Macro Reference manual provided separately.</p>														
(7) Data sheet output	<p>The data sheet is printed out at [0 → 1] (leading edge). This bit becomes valid when the data sheet function is set.</p>														
(8) Screen hard copy	<p>The TS series screen image is printed out at [0 → 1] (leading edge). This bit becomes valid when a printer is connected. It is also possible to make a screen hard copy using an internal switch [Function: Hard Copy].</p>														
(9) Backlight	<p>This bit becomes valid when an option other than [Always ON] is selected in the [Backlight] tab window that is displayed by selecting [System Setting] → [Unit Setting]. [0] (level): OFF when the conditions are satisfied [1] (level): ON</p>														
(10) Screen internal switching	<p>This bit controls screen switching by internal switches. [0]: Screen switching by internal switches is enabled. [1]: Screen switching by internal switches is disabled. * An "internal switch" means a switch you can create for internal processing within TS series by selecting [Screen] or [Return] for [Function:] of the switch.</p>														
(11) Screen forced switching	<p>This bit is used for switching the screen using the read area "n + 2" when the required screen number has already been specified in "n + 2". ^{*3}</p>														
(12) Data read refresh	<p>All the data display items on the screen are refreshed at [0 → 1] (leading edge). This is applied to every data display item regardless of the setting for [Process Cycle].</p>														

*1 It is possible to make this function work with the bit in the level. For more information, refer to the V8 Series Reference Manual provided separately.

*2 As an exception, a multi-overlap may appear/disappear at the edge. For more information, refer to the V8 Series Reference Manual provided separately.

*3 Usage Example

Step a: Screen change according to read area "n + 2"

Step b: Screen change with an internal switch

Step c: Screen change to the same screen number as step 1 according to read area "n + 2"

In this case, however, the same value is stored in read area "n + 2" so the command is not valid. In such a case, it is possible to forcibly switch the screen to the screen number contained in read area "n + 2" at the leading edge [0 → 1] of bit 14.

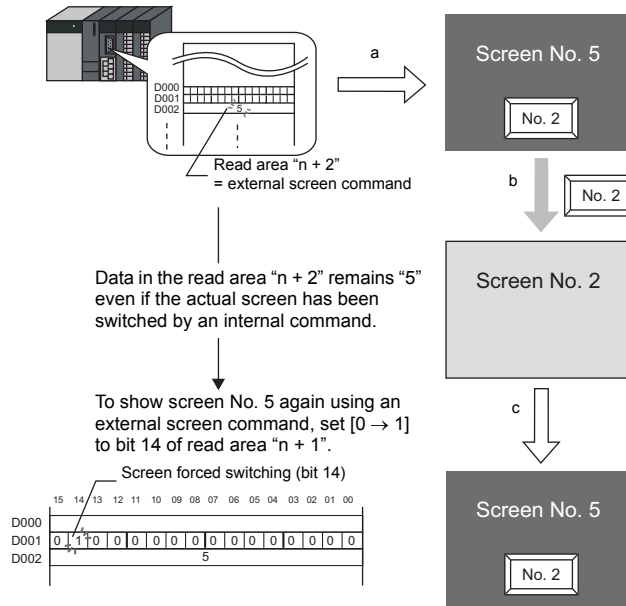

Reset to this bit after you check that bit 14 of write area "n+1" is set to "1" or the same value is stored in write area "n+2" as the value in read area "n+2".

Read area "n + 2" (screen number command)																
15	14	13	12	11	10	09	08	07	06	05	04	03	02	01	00	
																(1) Screen number
(1) Screen number command *1		0 to 9999 These bits are used for switching the screen by an external command. When a screen number is specified in these bits, the screen is displayed. Even if the screen has been switched using an internal switch, it is possible to switch the screen using an external command from the PLC. External commands have priority over internal switches.														

*1 Screen No. Error

When TS series has started communications with the PLC, the screen of the screen number specified in read area "n + 2" is displayed. If the screen number specified in read area "n + 2" does not exist in the screen data, "Screen No. Error" is displayed on TS series.

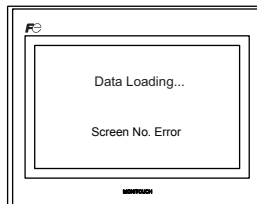

Before starting communications with the PLC, check the data in [Read Area] "n + 2" and confirm that the screen number to be displayed at first is specified.

Write area

This is the area where data is written from [Read Area], such as the displayed screen number, overlap display status, buzzer sounding status, etc. Three words of consecutive memory addresses are secured. TS series writes information to these three words during communications with the PLC. When the TS series has completed a display operation, sub command/data in [Read Area] "n" is written.

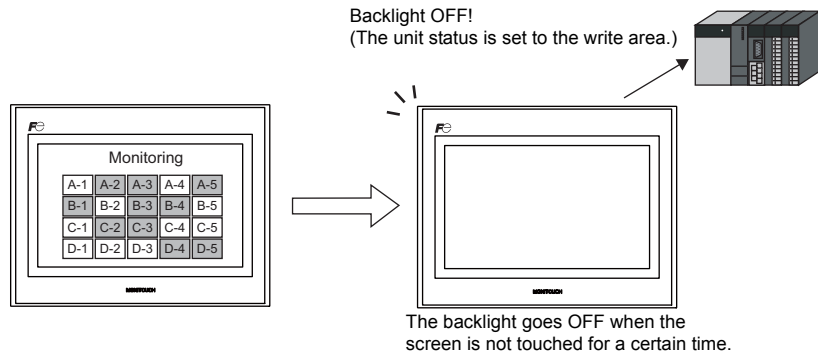

Memory addresses are allocated as shown below.

Address	Contents	Operation
n	Same as data in read area "n"	TS series → PLC
n + 1	Screen status	
n + 2	Displayed screen number	

Write area =

* Data in these memory addresses is saved at \$s464 to 466 of the TS series internal memory. For more information on the internal memory (\$s), refer to the V8 Series Reference Manual.

Write Area "n" (output of read area "n")															
15	14	13	12	11	10	09	08	07	06	05	04	03	02	01	00
0	0	0	0												
												(1) Free			
												(2) BZ0			
												(3) BZ1			
												(4) BZ2			
												(5) Calendar setting			
												(6) System reserved			
(1) Free		These bits reflect the data in read area "n" at the time TS series has been finished with processing.													
(2) BZ0															
(3) BZ1															
(4) BZ2															
(5) Calendar setting															
(6) System reserved		Always "0"													

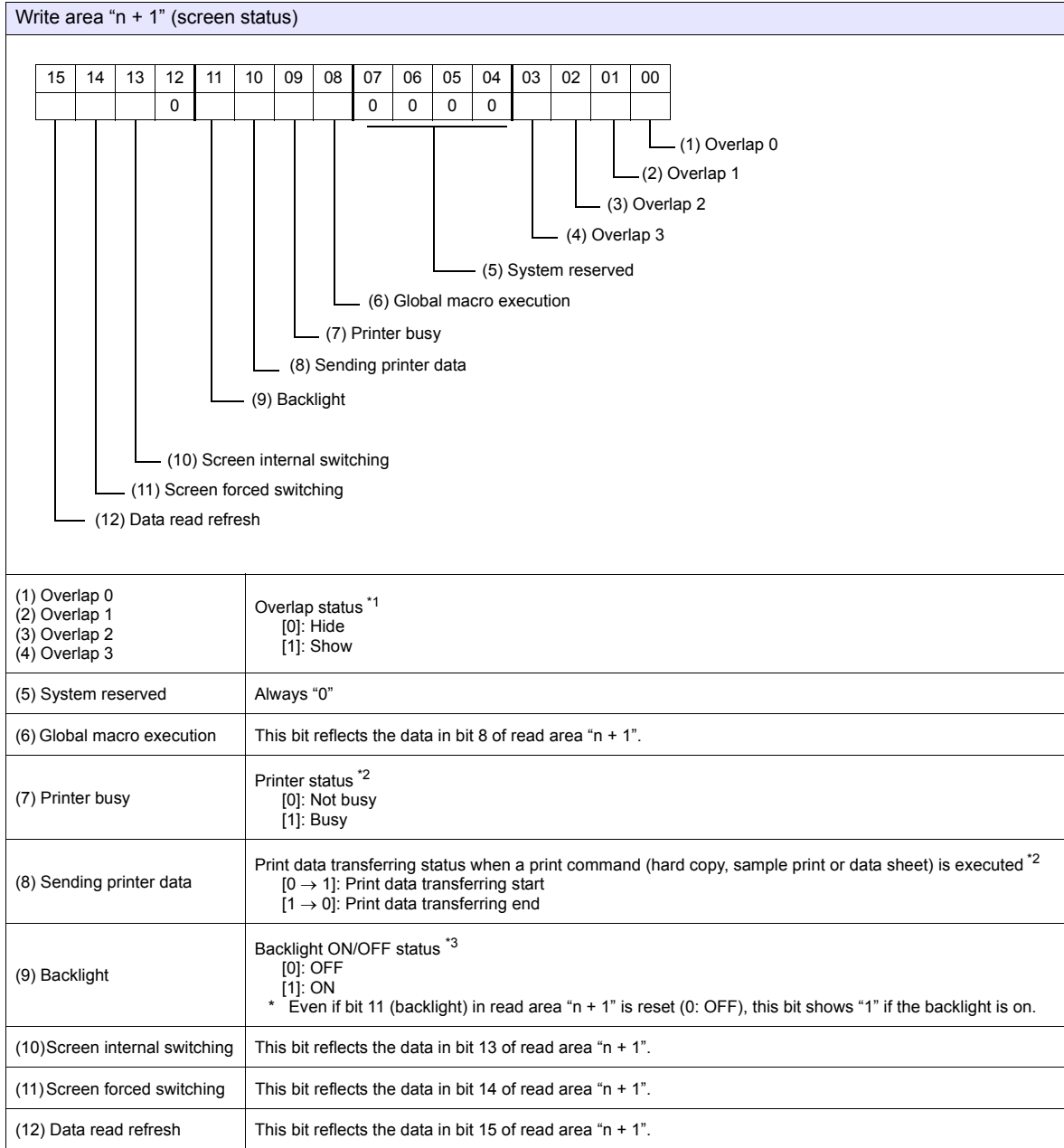

*1 Example:

- a. Display overlap No. 0 from read area (n + 1) using an external command.
 - b. Display overlap No. 0 internally using the [Function: Overlap = ON] switch.
- In either case (a or b), bit 0 of write area "n + 1" is set (ON).
 In the case of b, the bit in read area "n + 1" remains "0".

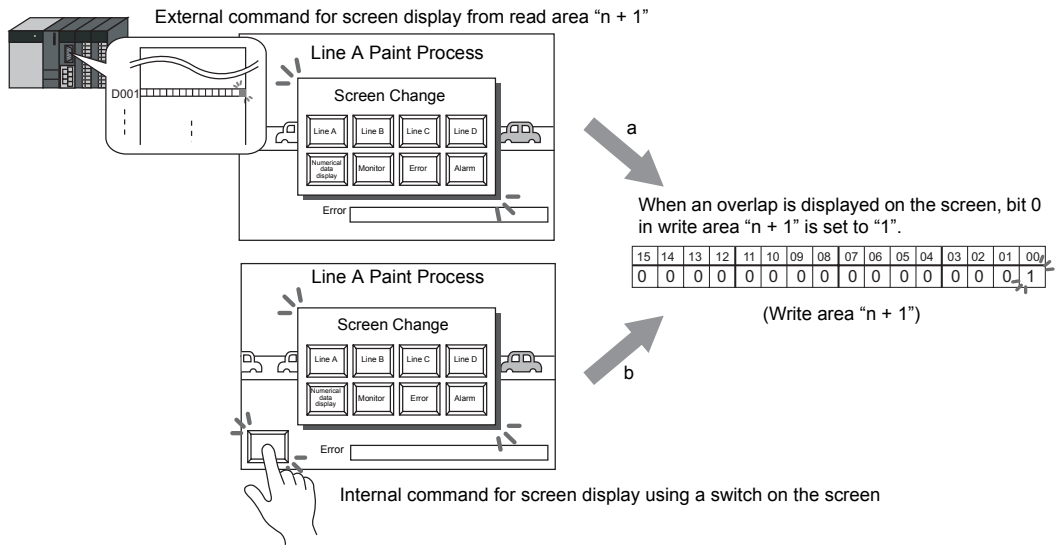

- *2 Data of bits 9 and 10 is output to internal memory address \$s16. For more information on the internal memory (\$s), refer to the V8 Series Reference Manual.
- *3 Data of bit 11 is output to internal memory address \$s17. For more information on the internal memory (\$s), refer to the V8 Series Reference Manual.

Write area "n + 2" (displayed screen number)															
15	14	13	12	11	10	09	08	07	06	05	04	03	02	01	00
											(1) Screen number				
(1) Screen number	0 to 9999 Screen number currently displayed														

GD-80 Compatible

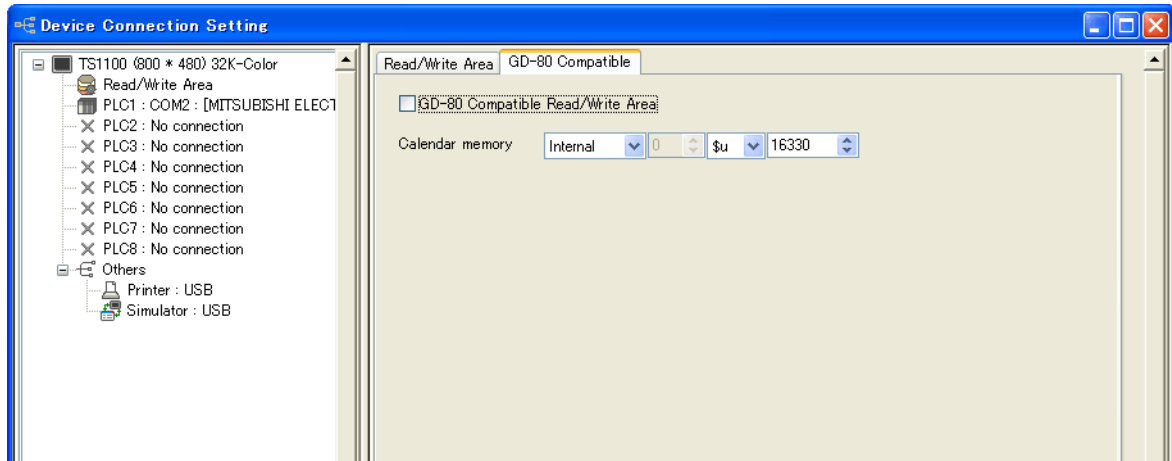

<input type="checkbox"/> GD-80 Compatible Read/Write Area	<p>When converting screen data files created on the MONITOUCH GD-80/81S series into those of the TS series, this option is automatically checked.</p> <ul style="list-style-type: none"> • Unchecked: The memory addresses allocated to the TS series are applied to the read and write areas. (See page 1-27.) • Checked: The memory addresses allocated to the GD-80/81S series are applied to the read and write areas. For more information on [Read Area] and [Write Area] of the GD-80/81S series, refer to the GD-80 User's Manual provided separately.
Calendar memory	Use this memory area when the connected device is not equipped with the calendar function and the TS series built-in clock * is not used.

Calendar memory

Follow the steps below to set the calendar memory.

1. Specify the desired memory address for [Calendar memory]. Six words are occupied consecutively.
2. Save calendar data in the calendar memory addresses specified in step 1 in BCD notation.
The allocation of calendar memory is shown below.

Memory	Contents
n	Year (BCD 0 to 99)
n + 1	Month (BCD 1 to 12)
n + 2	Day (BCD 1 to 31)
n + 3	Hour (BCD 0 to 23)
n + 4	Minute(s) (BCD 0 to 59)
n + 5	Second(s) (BCD 0 to 59)

The day of the week is automatically recognized from the above data. It is not necessary to input any data.

3. Set bit 11 (calendar setting) of read area "n". At the leading edge of this bit (0 → 1), data in calendar memory is set for calendar data.

*1 Calendar data is cleared when the power is turned off. When the power is turned on, set calendar data according to the procedure mentioned above.

*2 When using the calendar memory, automatic reading of calendar data at the time of PLC connection as well as once-a-day automatic correction is not performed. Consequently, some errors may be introduced. Perform the procedure described above at regular intervals.

1.5.3 Others

Printer

Make the setting when connecting to a printer. Refer to the V8 Series Reference Manual.

Simulator

Make the setting if also saving the simulator communication program together with screen data to the storage (e.g. USB memory) under the storage manager.

MEMO

Please use this page freely.

2. ALLEN BRADLEY

2.1 PLC Connection

2.1 PLC Connection

Serial Connection

PLC Selection on the Editor	CPU	Unit/Port	Signal Level	TS Port	Connection	Ladder Transfer ^{*2}
PLC-5	PLC-5/10, PLC-5/12, PLC-5/15, PLC-5/25	1785-KE	RS-232C	COM2	Wiring diagram 3 - COM2	×
		1770-KF2	RS-232C	COM2	Wiring diagram 4 - COM2	
			RS-422	COM1	Wiring diagram 2 - COM1	
	PLC-5/11, PLC-5/20, PLC-5/20E, PLC-5/30, PLC-5/40, PLC-5/40L, PLC-5/40E, PLC-5/60, PLC-5/60L, PLC-5/80, PLC-5/80E	Channel 0	RS-232C	COM2	Wiring diagram 4 - COM2	
			RS-422	COM1	Wiring diagram 3 - COM1	
		1785-KE	RS-232C	COM2	Wiring diagram 3 - COM2	
		1770-KF2	RS-232C	COM2	Wiring diagram 4 - COM2	
			RS-422	COM1	Wiring diagram 2 - COM1	
Control Logix / Compact Logix	1756 Control Logix	Logix 5550	RS-232C	COM2	Wiring diagram 1 - COM2 ^{*1}	
	1769 Compact Logix	Channel 0				
SLC500	SLC5/03 and later	Channel 0	RS-232C	COM2	Wiring diagram 2 - COM2	
		1747-KE DF1	RS-232C	COM2	Wiring diagram 1 - COM1	
			RS-422	COM1		
MicroLogix	MicroLogix 1000 MicroLogix 1100 MicroLogix 1500	Channel 0	RS-232C	COM2	Allen Bradley "1761-CBL-PM02" + "Wiring diagram 5 - COM2 "	

*1 Cable "1756-CP3" (Allen Bradley) also usable

*2 For the ladder transfer function, see "Appendix 5 Ladder Transfer Function".

Ethernet Connection

PLC Selection on the Editor	CPU	Unit	TCP/IP	UDP/IP	Port No.	Ladder Transfer ^{*1}
PLC-5 (Ethernet)	PLC-5/20E PLC-5/40E PLC-5/80E	-	○	×	44818 fixed	×
Control Logix (Ethernet)	Logix 5550	1756-ENBT/A	○	×	44818 fixed	
	1769-L32E 1769-L35E 1769-L27ERM-QBFC1B	-				
SLC500 (Ethernet TCP/IP)	SLC 5/05	1747-L551 1747-L552 1747-L553				
MicroLogix (Ethernet TCP/IP)	MicroLogix 1100	-				
NET-ENI (SLC500 Ethernet TCP/IP)	SLC 5/03 SLC 5/04 SLC 5/05	1761-NET-ENI 1761-NET-ENIW				○
NET-ENI (MicroLogix Ethernet TCP/IP)	MicroLogix 1000 MicroLogix 1100 MicroLogix 1200 MicroLogix 1500	1761-NET-ENI 1761-NET-ENIW	○	×	Fixed to 44818 (Max. 6 units)	

*1 For the ladder transfer function, see "Appendix 5 Ladder Transfer Function".

2.1.1 PLC-5

Communication Setting

Editor

Communication setting

(Underlined setting: default)

Item	Setting	Remarks
Connection Mode	<u>1</u> :1 / 1 : n / Multi-link2 / Multi-link2 (Ethernet) / 1 : n Multi-link2 (Ethernet)	
Signal Level	<u>RS-232C</u> / RS-422/485	
Baud Rate	4800 / 9600 / <u>19200</u> bps	
Data Length	7 / <u>8</u> bits	Fixed to 8 bits except for Channel 0
Stop Bit	<u>1</u> / 2 bits	
Parity	None / <u>Even</u>	
Target Port No.	<u>0</u> to 31	

PLC

Series A 1785-KE

SW-1 (RS-232C Link Features)

No.	Item	Setting	Remarks
1, 2, 5	RS-232C Link Features	SW1: OFF SW2: OFF SW5: OFF	Error check: BCC Parity: None Embedded response: No
		SW1: ON SW2: OFF SW5: OFF	Error check: BCC Parity: Even Embedded response: No
3	Detect duplicate messages	ON	Detect and ignore duplicate messages
4	Hand shaking signals	OFF	Ignore handshaking signals

SW-2 (For Future Use)

No	Setting	Remarks
1, 2	OFF Always OFF (system reserved)	

SW-3, SW-4 (Node Number)

SW	Item	Setting	Remarks
SW-3	First digit (OCT)	No. 0 1 2 3 4 5 6 7	Setting example: Station number 15 (DEC) = 17 (OCT)
		SW1 OFF ON OFF ON OFF ON OFF ON	
		SW2 OFF OFF ON ON OFF OFF ON ON	
		SW3 OFF OFF OFF OFF ON ON ON ON	
SW-4	Second digit (OCT)	No. 0 1 2 3 4 5 6 7	SW-3: ON, OFF, OFF SW-4: ON, ON, ON
		SW1 OFF ON OFF ON OFF ON OFF ON	
		SW2 OFF OFF ON ON OFF OFF ON ON	
		SW3 OFF OFF OFF OFF ON ON ON ON	

SW-5 (Network Link Communication Rate)

No.	Item	Setting	Remarks
1	Network Communication Rate	ON	For DH+ port
2		ON	
		57600 bps	

SW-6 (RS-232C Communication Rate and Diagnostic Commands)

No.	Item	Setting				Remarks
1	RS-232C Communication Rate					Set the same value as the one set on TS.
2			4800 bps	9600 bps	19200 bps	
3		SW1	ON	OFF	ON	
		SW2	OFF	ON	ON	
	SW3	ON	ON	ON		
4	Diagnostic Commands	ON	Execute diagnostic commands			

Series B 1785-KE**SW-1 (RS-232C Link Features)**

No.	Item	Setting		Remarks
1-3	RS-232C Link Features	SW1: OFF SW2: OFF SW3: OFF	Error check: BCC Parity: None Embedded response: No	
		SW1: ON SW2: OFF SW3: OFF	Error check: BCC Parity: Even Embedded response: No	
4	Detect duplicate messages	ON	Detect and ignore duplicate messages	
5	Hand shaking signals	OFF	Ignore handshaking signals	
6	Diagnostic Commands	ON	Execute diagnostic commands	

SW-2 (Node Number)

No.	Item	Setting										Remarks
1	Octal Digit 0	0										
2		SW1: ON SW2: ON										
3-5	Octal Digit 1											Setting example: Station number 15 (DEC) = 17 (OCT)
		No.	0	1	2	3	4	5	6	7		
		SW3	OFF	ON	OFF	ON	OFF	ON	OFF	ON		
		SW4	OFF	OFF	ON	ON	OFF	OFF	ON	ON		
6-8	Octal Digit 2											SW3-5: ON, OFF, OFF SW6-8: ON, ON, ON
		No.	0	1	2	3	4	5	6	7		
		SW6	OFF	ON	OFF	ON	OFF	ON	OFF	ON		
		SW7	OFF	OFF	ON	ON	OFF	OFF	ON	ON		
	SW8	OFF	OFF	OFF	OFF	ON	ON	ON	ON			

SW-3 (Communication Rates and Local/Remote Option)

No.	Item	Setting				Remarks
1	Network Communication Rate	ON		57600 bps		For DH+ port
2		ON				
3-5	RS-232 Link Baud Rate					Set the same value as the one set on TS.
			4800 bps	9600 bps	19200 bps	
		SW3	ON	OFF	ON	
		SW4	OFF	ON	ON	
	SW5	ON	ON	ON		
6	Local / Remote operation	ON	Local mode			

SW-4 (For Future Use)

No.	Setting		Remarks
1-4	OFF	Always OFF (system reserved)	

* Series B 1785-KE switch: ON = 0: DOWN (lower), OFF = 1: UP (upper)

1770-KF2

Setting changes will take effect when the power is turned on. After changing a setting, turn the power off and back on again.

SW-1 (Asynchronous Link Features)

No.	Item	Setting		Remarks
1, 2, 5	Asynchronous Link Features	SW1: OFF SW2: OFF SW5: OFF	Error check: BCC Parity: None Embedded response: No	
		SW1: ON SW2: OFF SW5: OFF	Error check: BCC Parity: Even Embedded response: No	
3	Detect duplicate messages	ON	Detect and ignore duplicate messages	
4	Hand shaking signals	OFF	Ignore handshaking signals	

SW-2, SW-3, SW-4 (Station Number)

SW	Item	Setting								Remarks	
SW-2	First Digit	0 SW1: ON SW2: ON								Setting example: Station number 15 (DEC) = 17 (OCT) SW-3: ON, OFF, OFF SW-4: ON, ON, ON	
SW-3	Second Digit (OCT)	No.	0	1	2	3	4	5	6		7
		SW3	OFF	ON	OFF	ON	OFF	ON	OFF		ON
		SW4	OFF	OFF	ON	ON	OFF	OFF	ON		ON
SW-4	Third Digit (OCT)	No.	0	1	2	3	4	5	6	7	
		SW6	OFF	ON	OFF	ON	OFF	ON	OFF	ON	
		SW7	OFF	OFF	ON	ON	OFF	OFF	ON	ON	
		SW8	OFF	OFF	OFF	OFF	ON	ON	ON	ON	

SW-5 (Network Link Communication Rate)

No.	Item	Setting		Remarks
1	Network Communication Rate	ON	57600 bps	For DH+ port
2		ON		

SW-6 (Asynchronous Link Communication Rate and Diagnostic Commands)

No.	Item	Setting			Remarks
1, 2, 3	Asynchronous Communication Rate		4800 bps	9600 bps	Set the same value as the one set on TS.
		SW1	ON	OFF	
		SW2	OFF	ON	
		SW3	ON	ON	
4	Diagnostic Commands	ON	Execute Received Diagnostic Commands		

SW-7 (Selecting the Network Link)

No.	Item	Setting		Remarks
1	Selecting the Network Link	ON	Peer Communication Link	
2		OFF		

SW-8 (RS-232-C/RS-422-A Selection)

No.	Item	Setting			Remarks
1, 2	Selection of RS-232C / RS-422-A		RS-232C	RS-422	
		SW1	OFF	ON	
		SW2	ON	OFF	

Channel 0

SW-2 (Selection of RS-232C/RS-422A)

SW	Setting			Remarks
	No.	RS-232C	RS-422A	
SW2	1	ON	OFF	ON: Lower position OFF: Upper position
	2	ON	OFF	
	3	ON	ON	
	4	OFF	OFF	
	5	OFF	OFF	
	6	ON	OFF	
	7	ON	OFF	
	8	OFF	OFF	
	9	ON	ON	
	10	OFF	OFF	

Channel Configuration

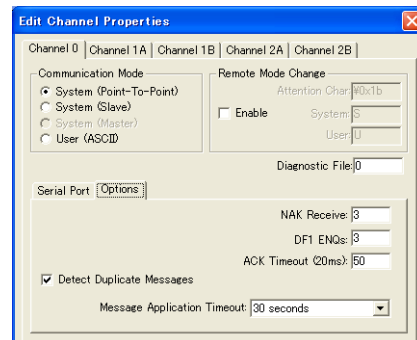
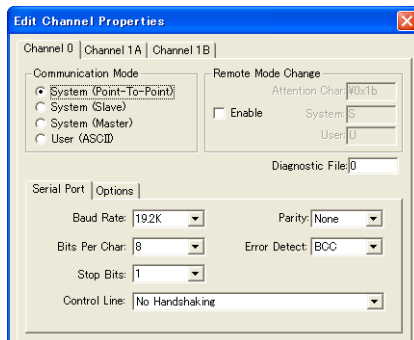

	Item	Setting	Remarks
Channel 0	Communication Mode	System (Point to Point)	
	Remote Mode Change	Unchecked	
Serial Port	Baud Rate	4800 / 9600 / 19.2 K	
	Bits Per Char	7 / 8	
	Stop Bits	1 / 2	
	Control Line	No Handshaking	
	Parity	NONE / EVEN	
Options	Error Detect	BCC	
	Detect Duplicate Messages	Checked	
	NAK Receive	3	
	DF1 ENQs	3	
	ACK Timeout (20 msec)	50	
	Message application timeout	30 seconds	

Available Memory

The available memory setting range varies depending on the PLC model. Be sure to set within the range available for the PLC. Use [TYPE] when assigning the indirect memory for macro programs.

Memory	TYPE	Remarks
N (integer)	00H	
B (bit)	01H	
T.ACC (timer/current value)	02H	
T.PRE (timer/set value)	03H	
C.ACC (counter/current value)	04H	
C.PRE (counter/set value)	05H	
I (input)	06H	
O (output)	07H	
S (status)	08H	
T (timer/control)	09H	
C (counter/control)	0AH	
R (control)	0BH	
R.LEN (control/data length)	0CH	
R.POS (control/data position)	0DH	
D (BCD)	0EH	
A (ASCII)	0FH	
F (FLOAT)	10H	Real number
ST (STRING)	11H	

Make settings for "Data Files" using the ladder tool. Otherwise, "Error Code F007", etc. is displayed on TS series. For more information, refer to the PLC manual issued by the manufacturer.

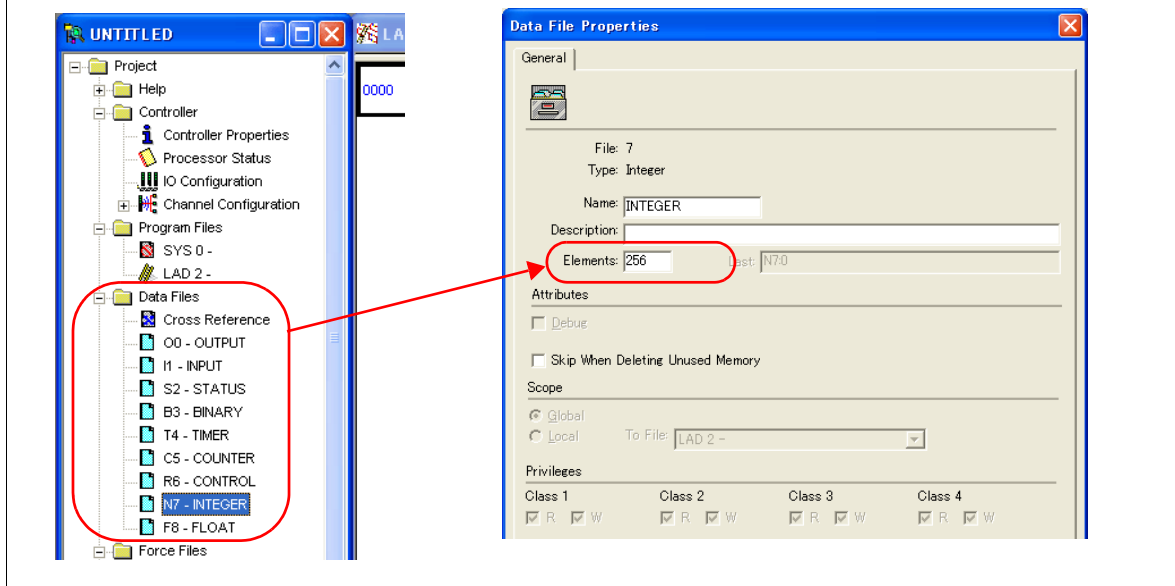

Address denotations

The assigned memory is indicated when editing the screen as shown below.

Example: For word access

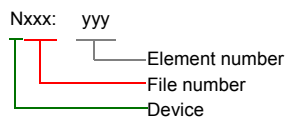

For bit access

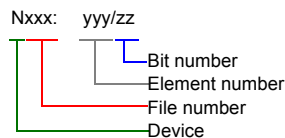

The file number will not be displayed for the input, output or status memory.

Indirect Memory Designation

- For the file numbers 0 to 65:

	15	MSB	8	7	LSB	0
n + 0	Model			Memory type		
n + 1	Address No.					
n + 2	00			Bit designation		
n + 3	00			Station number		

- For the file numbers 66 to 255:

	15	MSB	8	7	LSB	0
n + 0	Model			Memory type		
n + 1	Lower address No.					
n + 2	Higher address No.					
n + 3	00			Bit designation		
n + 4	00			Station number		

- Specify the file number as well as the element number for the address number.

Example: When specifying N007:123
Specify "7123" (DEC) for the address number.

Example: When specifying N120:123
Specify "120123" (DEC) for the address number.
120123 (DEC) is equivalent to 1D53B (HEX). Specify "D53B (HEX)" for the lower address number and "0001" for the upper address number.

- When specifying an address for the timer (control), counter (control) or control device in bit designation, specify the bit number in decimal notation as shown below:
 - T: Timer (control)
DN = 13, TT = 14, EN = 15
 - C: Counter (control)
UA = 10, UN = 11, OV = 12, DN = 13, CD = 14, CU = 15
 - R: Control
FD = 08, IN = 09, UL = 10, ER = 11, EM = 12, DN = 13, EU = 14, EN = 15

2.1.2 PLC-5 (Ethernet)

Communication Setting

Editor

Make the following settings on the editor. For more information, see “Appendix 2 Ethernet”.

- IP address for the TS unit
 - When specified on the screen data:
[System Setting] → [Ethernet Communication] → [Local Port IP Address]
 - When specified on the TS unit:
Main Menu screen → [Ethernet]
- Port number for the TS unit (for communication with PLC)
[System Setting] → [Device Connection Setting] → [Communication Setting]
- IP address and port number (No. 44818) of the PLC
[System Setting] → [Device Connection Setting] → [PLC Table]

PLC

Channel 2

Channel Configuration (Channel 2)

The screenshot shows the 'Edit Channel Properties' window for Channel 2. It is divided into two main sections: 'Ethernet Configuration' and 'Advanced Functions'.
 In the 'Ethernet Configuration' section:
 - Ethernet Address: 00:00:BC:1C:BF:D2
 - Network Configuration Type: Static (selected), Dynamic (unselected)
 - Use DHCP to obtain network configuration: (unselected)
 - Use BOOTP to obtain network configuration: (selected)
 - IP Address: 192.168.1.2
 - Message Connect Timeout (msec): 15000
 - Message Reply Timeout (msec): 3000
 - Inactivity Timeout (minutes): 30
 - Link ID: 0
 In the 'Advanced Functions' section:
 - Subnet Mask: 255.255.255.0
 - Gateway Address: 0.0.0.0

Item	Setting	Remarks
Network Configuration Type	Static	
IP Address	Set the IP address of the PLC.	
Subnet Mask	Set the subnet mask of the PLC.	
Gateway Address	Specify according to the environment.	

Available Memory

The available memory setting range varies depending on the PLC model. Be sure to set within the range available for the PLC. Use [TYPE] when assigning the indirect memory for macro programs.

Memory	TYPE	Remarks
N (integer)	00H	
B (bit)	01H	
T.ACC (timer/current value)	02H	
T.PRE (timer/set value)	03H	
C.ACC (counter/current value)	04H	
C.PRE (counter/set value)	05H	
I (input)	06H	
O (output)	07H	
S (status)	08H	
T (timer/control)	09H	
C (counter/control)	0AH	
R (control)	0BH	
R.LEN (control/data length)	0CH	
R.POS (control/data position)	0DH	
D (BCD)	0EH	
A (ASCII)	0FH	
F (FLOAT)	10H	Real number
ST (STRING)	11H	

Make settings for "Data Files" using the ladder tool. Otherwise, "Error Code F007", etc. is displayed on TS series. For more information, refer to the PLC manual issued by the manufacturer.

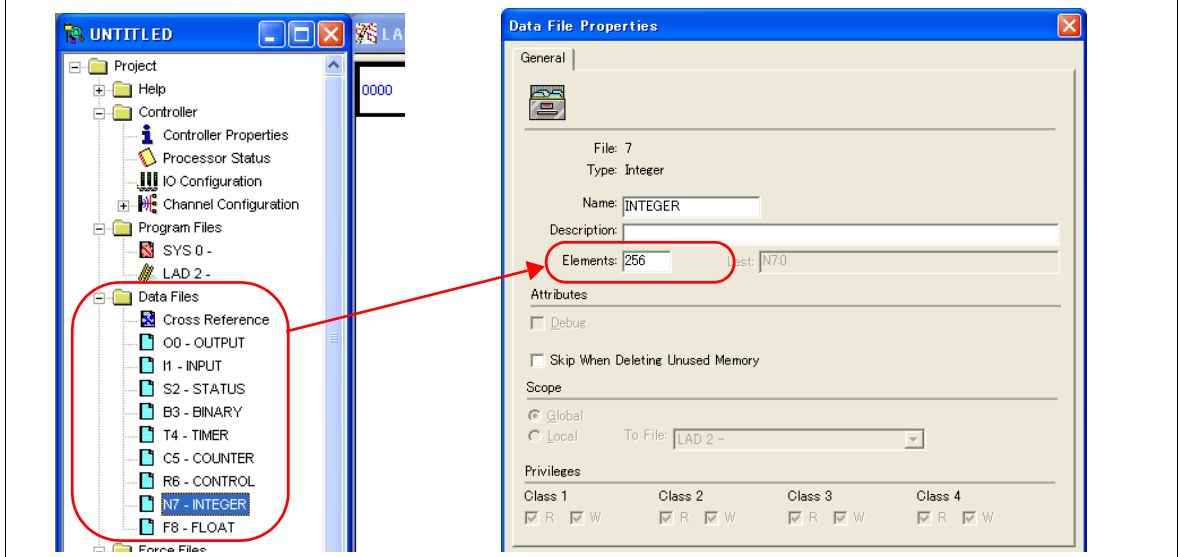

Address denotations

The assigned memory is indicated when editing the screen as shown below.

Example: For word access

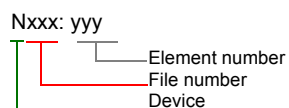

For bit access

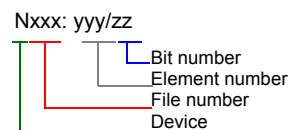

The file number will not be displayed for the input, output or status memory.

Indirect Memory Designation

- For the file numbers 0 to 65:

	15	MSB	8	7	LSB	0
n+0	Model			Memory type		
n+1	Address No.					
n+2	00			Bit designation		
n+3	00			Station number		

- For the file numbers 66 to 255:

	15	MSB	8	7	LSB	0
n+0	Model			Memory type		
n+1	Lower address No.					
n+2	Higher address No.					
n+3	00			Bit designation		
n+4	00			Station number		

- Specify the file number as well as the element number for the address number.

Example: When specifying N007:123
Specify "7123" (DEC) for the address number.

Example: When specifying N120:123
Specify "120123" (DEC) for the address number.
120123 (DEC) is equivalent to 1D53B (HEX). Specify "D53B (HEX)" for the lower address number and "0001" for the higher address number.

- When specifying an address for the timer (control), counter (control) or control device in bit designation, specify the bit number in decimal notation as shown below:
 - T: Timer (control)
DN = 13, TT = 14, EN = 15
 - C: Counter (control)
UA = 10, UN = 11, OV = 12, DN = 13, CD = 14, CU = 15
 - R: Control
FD = 08, IN = 09, UL = 10, ER = 11, EM = 12, DN = 13, EU = 14, EN = 15

2.1.3 Control Logix / Compact Logix

The logical port PLC1 can only be selected because the tag table is used.

Communication Setting

Editor

Communication setting

(Underlined setting: default)

Item	Setting	Remarks
Connection Mode	<u>1</u> : 1 / Multi-link2	For multi-link2, be sure to use the same tag table.
Signal Level	<u>RS-232C</u> / RS-422/485	
Baud Rate	4800 / 9600 / <u>19200</u> / 38400 / 57600 115k bps	
Data Length	<u>8</u> bits	
Stop Bit	<u>1</u> / 2 bits	
Parity	<u>None</u> / Odd / Even	
Target Port No.	<u>0</u> to 31	

PLC

Control Logix

Serial port

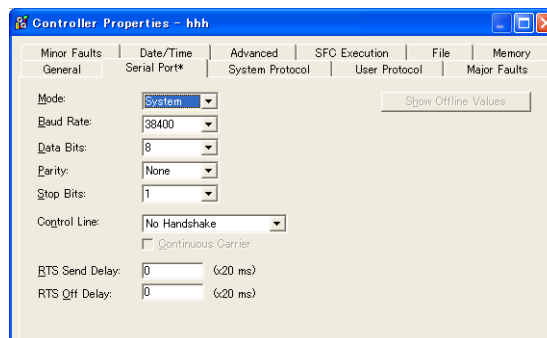

Item	Setting	Remarks
MODE	System	
Baud Rate	38400	
Data Bits	8	
Parity	None	
Stop Bits	1	
Control Line	No Handshake	

System protocol

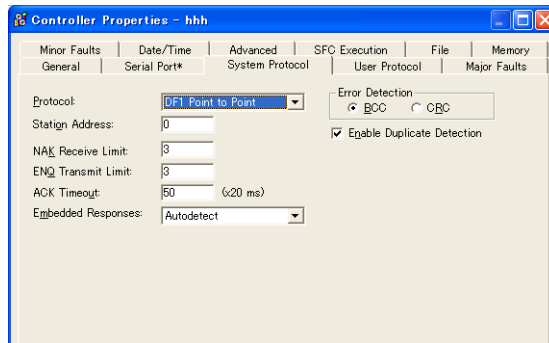

Item	Setting	Remarks
Protocol	DF1 Point to Point	
Station Address	0	
NAK Receive Limit	3	
ENQ Transmit Limit	3	
ACK Timeout	50	
Embedded Responses	Autodetect	
Error Detection	BCC	
Enable Duplicate Detection	Checked	

Compact Logix

CH0 - serial port

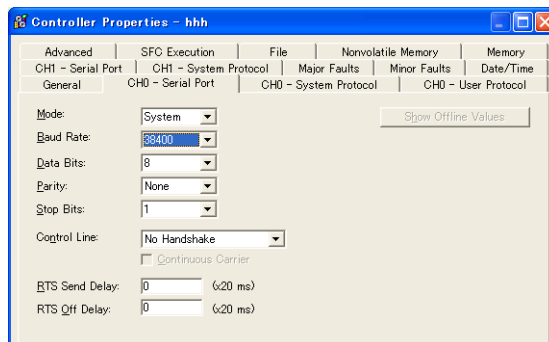

Item	Setting	Remarks
MODE	System	
Baud Rate	38400	
Data Bits	8	
Parity	None	
Stop Bits	1	
Control Line	No Handshake	

CH0 - system protocol

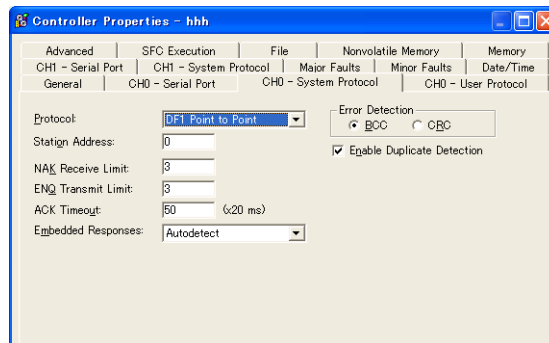

Item	Setting	Remarks
Protocol	DF1 Point to Point	
Station Address	0	
NAK Receive Limit	3	
ENQ Transmit Limit	3	
ACK Timeout	50	
Embedded Responses	Autodetect	
Error Detection	BCC	
Enable Duplicate Detection	Checked	

Available Memory

Create a CSV file by exporting "tag" created by using the ladder tool of the PLC. Then import the CSV file into the editor to set the PLC memory.

For more information on importing, exporting and creating a tag, refer to "Connection with A*B Control Logix" provided separately.

Indirect Memory Designation

Not available

2.1.4 Control Logix (Ethernet)

The logical port PLC1 can only be selected because the tag table is used.

Communication Setting

Editor

Make the following settings on the editor. For more information, see “Appendix 2 Ethernet”.

- IP address for the TS unit
 - When specified on the screen data:
[System Setting] → [Ethernet Communication] → [Local Port IP Address]
 - When specified on the TS unit:
Main Menu screen → [Ethernet]
- Port number for the TS unit (for communication with PLC)
[System Setting] → [Device Connection Setting] → [Communication Setting]
- IP address and port number (No. 44818) of the PLC
[System Setting] → [Device Connection Setting] → [PLC Table]

Valid only for 1 : 1 connection

IP address and port number (No. 44818) for the PLC

No.	Port Name	IP Address	Port No.
0			
1	PLC1	192.168.1.1	44818
2			
3			
4			
5			
6			
7			
8			
9			
10			
11			
12			
13			

- Others
[System Setting] → [Device Connection Setting] → [Communication Setting] → [CPU Slot No. Setting]
 - Unchecked (default)
The CPU slot No. is fixed to “0”.

CPU SlotNo Setting

CPU	Ethernet		
Slot No.0	Slot No.1	Slot No.2	Slot No.3

- Checked
Specify the CPU slot number for [PLC Table] in the [Target Settings] tab window ([System Setting] → [Device Connection Setting]).
Setting range: 0 to 16

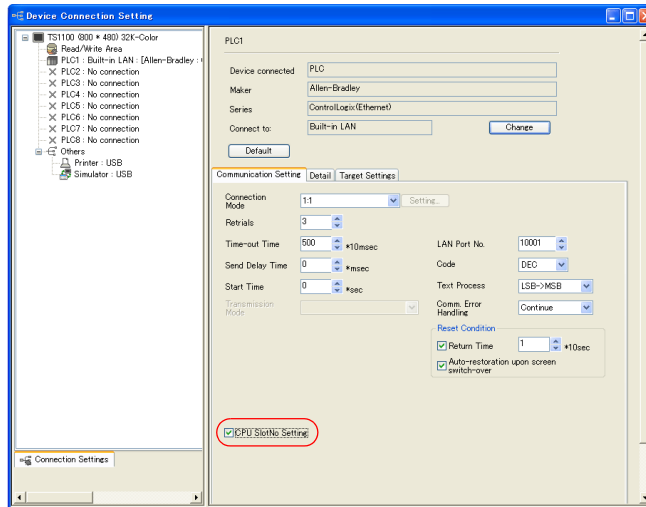

	Ethernet	CPU	
Slot No.0	Slot No.1	Slot No.2	Slot No.3

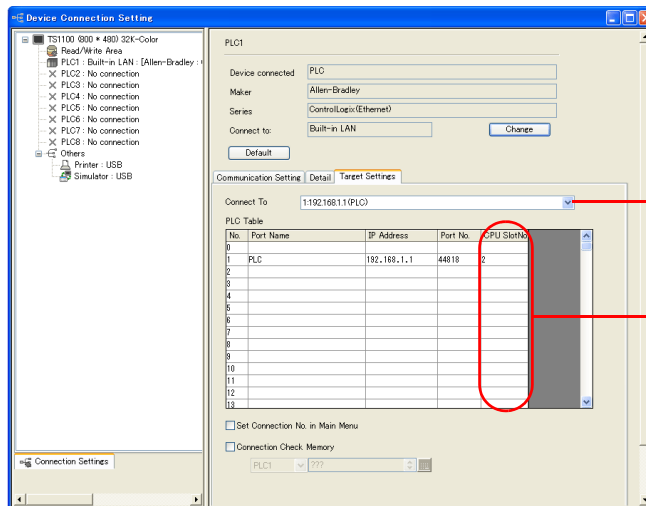

Valid only for 1 : 1 connection

CPU slot No. 0 to 16

PLC

Use one of the following utilities to set an IP address. For more information, refer to the PLC manual issued by the manufacturer.

- BOOTP utility
- RSLinx software
- RSLogix 5000 software

Available Memory

Create a CSV file by exporting "tag" created by using the ladder tool of the PLC. Then import the CSV file into the editor to set the PLC memory.

For more information on importing, exporting and creating a tag, refer to "Connection with A*B Control Logix" provided separately.

Indirect Memory Designation

Not available

2.1.5 SLC500

Communication Setting

Editor

Communication setting

(Underlined setting: default)

Item	Setting	Remarks
Connection Mode	<u>1</u> :1 / 1:n / Multi-link2	
Signal Level	<u>RS-232C</u> / RS-422/485	
Baud Rate	4800 / 9600 / <u>19200</u> / 38400 bps	
Data Length	7 / <u>8</u> bits	
Stop Bit	<u>1</u> / 2 bits	
Parity	None / <u>Even</u>	
Target Port No.	<u>0</u> to 31	

PLC

Channel 0

Channel Configuration (chan. 0 - system)



The screenshot shows the 'Channel Configuration' dialog box with the following settings:

- Driver: DF1 Full Duplex
- Baud: 19200
- Parity: NONE
- Stop Bits: 1
- Source ID: 9 (decimal)
- Control Line: No Handshaking
- Error Detection: BCC
- Embedded Responses: Auto Detect
- Duplicate Packet Detect
- ACK Timeout (x20 ms): 50
- NAK Retries: 3
- ENQ Retries: 3

(Underlined setting: default)

Item	Setting	Remarks
Driver	DF1 Full Duplex	
Baud	9600 / 19200 / 38400	
Parity	<u>None</u> / Even	
Stop Bits	<u>1</u> / 2	
Control Line	No Handshaking	
Error Detection	BCC	
Embedded Responses	Auto Detect	
Duplicate Packet Detect	Checked	

1747-KE**Jumper JW2**

Item	Setting	Remarks
RS-232		
RS-422		

DF1 port setup menu

Item	Setting	Remarks
Baudrate	19200	
Bits Per Character	8	
Parity	Even	
Stop Bits	1	

DF1 full-duplex setup menu

Item	Setting	Remarks
Duplicate Packet Detection	Enabled	
Checksum	BCC	
Constant Carrier Detect	Disabled	
Message Timeout	400	
Hardware Handshaking	Disabled	
Embedded Response Detect	Auto Detect	
ACK Timeout (× 5 ms)	90	
ENquiry Retries	3	
NAK Received Retries	3	

Available Memory

The available memory setting range varies depending on the PLC model. Be sure to set within the range available for the PLC. Use [TYPE] when assigning the indirect memory for macro programs.

Memory	TYPE	Remarks
N (integer)	00H	
B (bit)	01H	
T. ACC (timer/current value)	02H	
T. PRE (timer/set value)	03H	
C. ACC (counter/current value)	04H	
C. PRE (counter/set value)	05H	
I (input)	06H	
O (output)	07H	
S (status)	08H	
T (timer/control)	09H	
C (counter/control)	0AH	
R (control)	0BH	
R. LEN (control/data length)	0CH	
R. POS (control/data position)	0DH	
D (BCD)	0EH	
A (ASCII)	0FH	
F (FLOAT)	10H	Real number
ST (STRING)	11H	

Make settings for "Data Files" using the ladder tool. Otherwise, "Error Code 10 00" is displayed on TS series. For more information, refer to the PLC manual issued by the manufacturer.

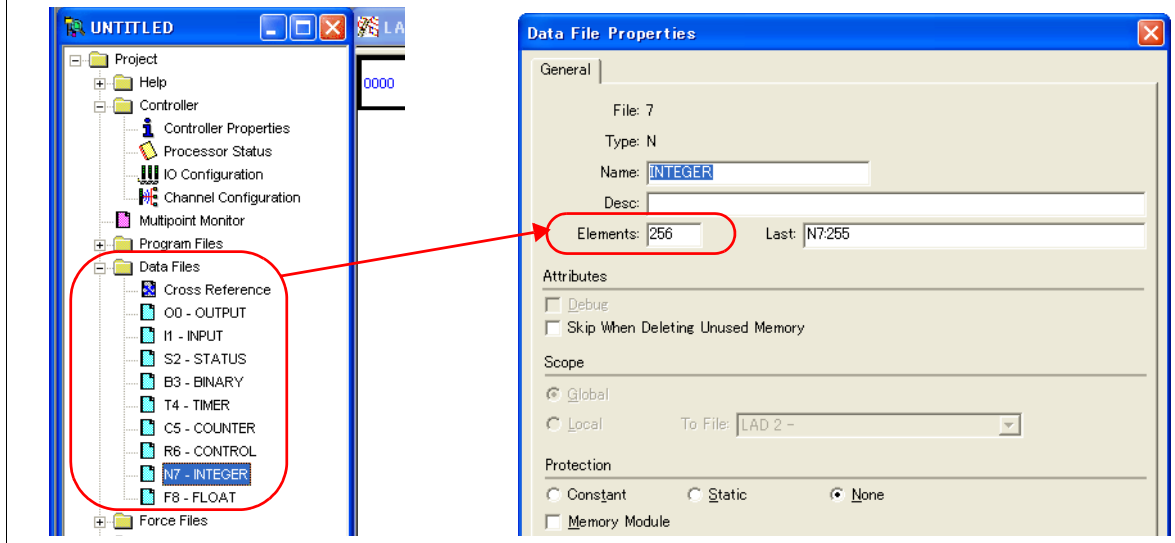

Address denotations

The assigned memory is indicated when editing the screen as shown below.

- Address other than input/output
- For word access

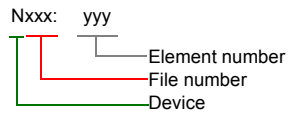

For bit access

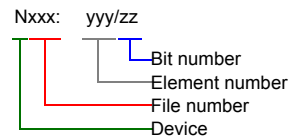

The file number will not be displayed for the input, output or status memory.

- Input/output address
- For word access

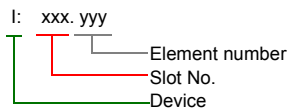

For bit access

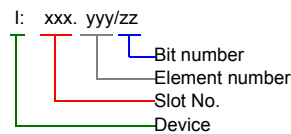

Indirect Memory Designation

- For the file or slot numbers 0 to 65:

	15	MSB	8	7	LSB	0
n + 0	Model			Memory type		
n + 1	Address No.					
n + 2	00		Bit designation			
n + 3	00		Station number			

- For the file or slot numbers 66 to 255:

	15	MSB	8	7	LSB	0
n + 0	Model			Memory type		
n + 1	Lower address No.					
n + 2	Higher address No.					
n + 3	00		Bit designation			
n + 4	00		Station number			

- Specify the file number or slot number and the element number for the address number.

Example: When specifying N007:123
Specify "7123" (DEC) for the address number.

Example: When specifying N120:123
Specify "120123" (DEC) for the address number.
120123 (DEC) is equivalent to 1D53B (HEX). Specify "D53B (HEX)" for the lower address number and "0001" for the upper address number.

- When specifying an address for the timer (control), counter (control) or control device in bit designation, specify the bit number in decimal notation as shown below:

- T: Timer (control)
DN = 13, TT = 14, EN = 15
- C: Counter (control)
UA = 10, UN = 11, OV = 12, DN = 13, CD = 14, CU = 15
- R: Control
FD = 08, IN = 09, UL = 10, ER = 11, EM = 12, DN = 13, EU = 14, EN = 15

2.1.6 SLC500 (Ethernet TCP/IP)

Communication Setting

Editor

Make the following settings on the editor. For more information, see “Appendix 2 Ethernet”.

- IP address for the TS unit
 - When specified on the screen data:
[System Setting] → [Ethernet Communication] → [Local Port IP Address]
 - When specified on the TS unit:
Main Menu screen → [Ethernet]
- Port number for the TS unit (for communication with PLC)
[System Setting] → [Device Connection Setting] → [Communication Setting]
- IP address and port number (No. 44818) of the PLC
[System Setting] → [Device Connection Setting] → [PLC Table]

PLC

Channel 1

Channel Configuration (Channel 1)

The screenshot shows the 'Channel Configuration' dialog box for 'Channel 1'. The 'Driver' is set to 'Ethernet'. The 'Hardware Address' is 000F:7301:07:FD. The 'IP Address' is 10.91.131.188, 'Subnet Mask' is 255.255.255.0, and 'Gateway Address' is 10.91.131.1. The 'DHRIO Link ID' is 0. Under 'Protocol Control', 'HTTP Server Enable' and 'Auto Negotiate' are checked. 'Msg Connection Timeout (x 1mS)' is 15000 and 'Msg Reply Timeout (x 1mS)' is 3000. The 'Port Setting' is 10/100 Mbps Full Duplex/Half Duplex.

Item	Setting	Remarks
Driver	Ethernet	
IP Address	PLC's IP address	
Subnet Mask	PLC's subnet mask	
Gateway Address	Make settings in accordance with the network environment.	

Available Memory

The available memory setting range varies depending on the PLC model. Be sure to set within the range available for the PLC. Use [TYPE] when assigning the indirect memory for macro programs.

Memory	TYPE	Remarks
N (integer)	00H	
B (bit)	01H	
T. ACC (timer/current value)	02H	
T. PRE (timer/set value)	03H	
C. ACC (counter/current value)	04H	
C. PRE (counter/set value)	05H	
I (input)	06H	
O (output)	07H	
S (status)	08H	
T (timer/control)	09H	
C (counter/control)	0AH	
R (control)	0BH	
R. LEN (control/data length)	0CH	
R. POS (control/data position)	0DH	
A (ASCII)	0FH	
F (FLOAT)	10H	Real number
ST (STRING)	11H	

Make settings for "Data Files" using the ladder tool. Otherwise, "Error Code 10 00" is displayed on TS series. For more information, refer to the PLC manual issued by the manufacturer.

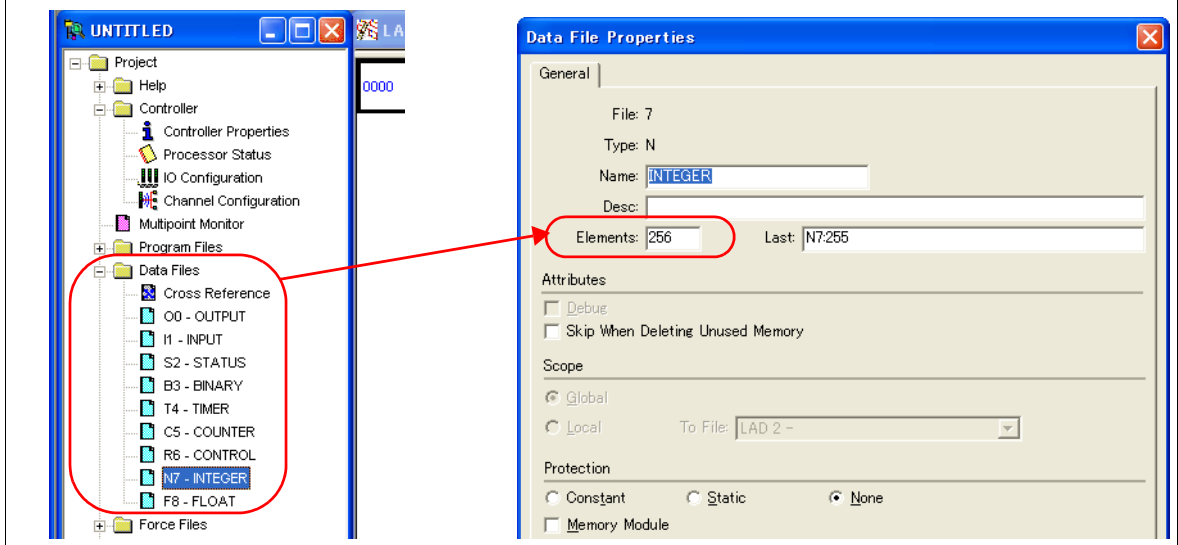

Address denotations

The assigned memory is indicated when editing the screen as shown below.

- Address other than input/output
- For word access

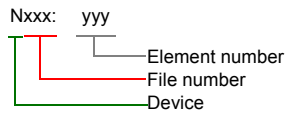

For bit access

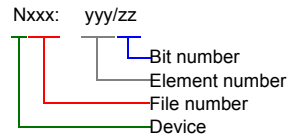

The file number will not be displayed for the input, output or status memory.

- Input/output address
- For word access

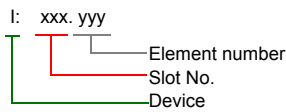

For bit access

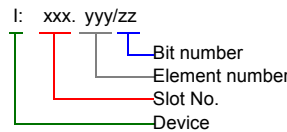

Indirect Memory Designation

- For the file or slot numbers 0 to 65:

	15	MSB	8	7	LSB	0
n + 0	Model			Memory type		
n + 1	Address No.					
n + 2	00		Bit designation			
n + 3	00		Station number			

- For the file or slot numbers 66 to 255:

	15	MSB	8	7	LSB	0
n + 0	Model			Memory type		
n + 1	Lower address No.					
n + 2	Higher address No.					
n + 3	00		Bit designation			
n + 4	00		Station number			

- Specify the file number or slot number and the element number for the address number.

Example: When specifying N007:123
Specify "7123" (DEC) for the address number.

Example: When specifying N120:123
Specify "120123" (DEC) for the address number.
120123 (DEC) is equivalent to 1D53B (HEX). Specify "D53B (HEX)" for the lower address number and "0001" for the upper address number.

- When specifying an address for the timer (control), counter (control) or control device in bit designation, specify the bit number in decimal notation as shown below:

- T: Timer (control)
DN = 13, TT = 14, EN = 15
- C: Counter (control)
UA = 10, UN = 11, OV = 12, DN = 13, CD = 14, CU = 15
- R: Control
FD = 08, IN = 09, UL = 10, ER = 11, EM = 12, DN = 13, EU = 14, EN = 15

2.1.7 Micro Logix

Communication Setting

Editor

Communication setting

(Underlined setting: default)

Item	Setting	Remarks
Connection Mode	<u>1</u> : 1 / Multi-link2	
Signal Level	<u>RS-232C</u> / RS-422/485	
Baud Rate	4800 / <u>9600</u> / 19200 / 38400 bps	
Data Length	7 / <u>8</u> bits	
Stop Bit	1 bit	
Parity	<u>None</u> / Even	
Target Port No.	<u>0</u> to 31	

PLC

Channel Configuration

Micro Logix 1000

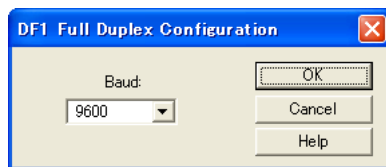

(Underlined setting: default)

Item	Setting	Remarks
Baud	4800 / <u>9600</u> / 19200 / 38.4K	

Micro Logix 1100, 1500

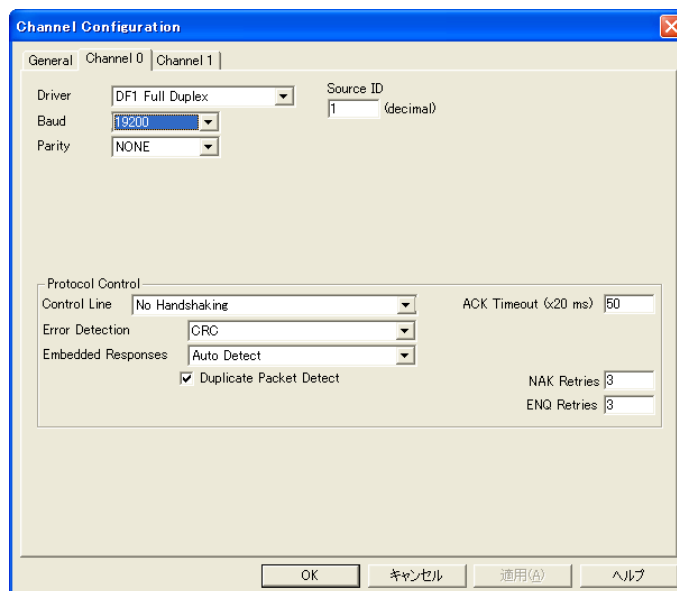

(Underlined setting: default)

Item	Setting	Remarks
Channel 0	Driver	DF1 Full Duplex
	Baud	4800 / 9600 / <u>19200</u> / 38.4K
	Parity	<u>None</u> / Even
	Control Line	No Handshaking
	Error Detection	BCC
	Embedded Responses	Auto Detect
	Duplicate Packet Detect	Checked

Calendar

This model is not equipped with the calendar function. Use the built-in clock of the TS series.

Available Memory

The available memory setting range varies depending on the PLC model. Be sure to set within the range available for the PLC. Use [TYPE] when assigning the indirect memory for macro programs.

Memory	TYPE	Remarks
N (integer)	00H	
B (bit)	01H	
T. ACC (timer/current value)	02H	
T. PRE (timer/set value)	03H	
C. ACC (counter/current value)	04H	
C. PRE (counter/set value)	05H	
I (input)	06H	
O (output)	07H	
S (status)	08H	
T (timer/control)	09H	
C (counter/control)	0AH	
R (control)	0BH	
R. LEN (control/data length)	0CH	
R. POS (control/data position)	0DH	
D (BCD)	0EH	
A (ASCII)	0FH	
F (FLOAT)	10H	Real number
ST (STRING)	11H	
L (LONG)	12H	Double-word

Make settings for "Data Files" using the ladder tool. Otherwise, "Error Code 10 00" is displayed on TS series. For more information, refer to the PLC manual issued by the manufacturer.

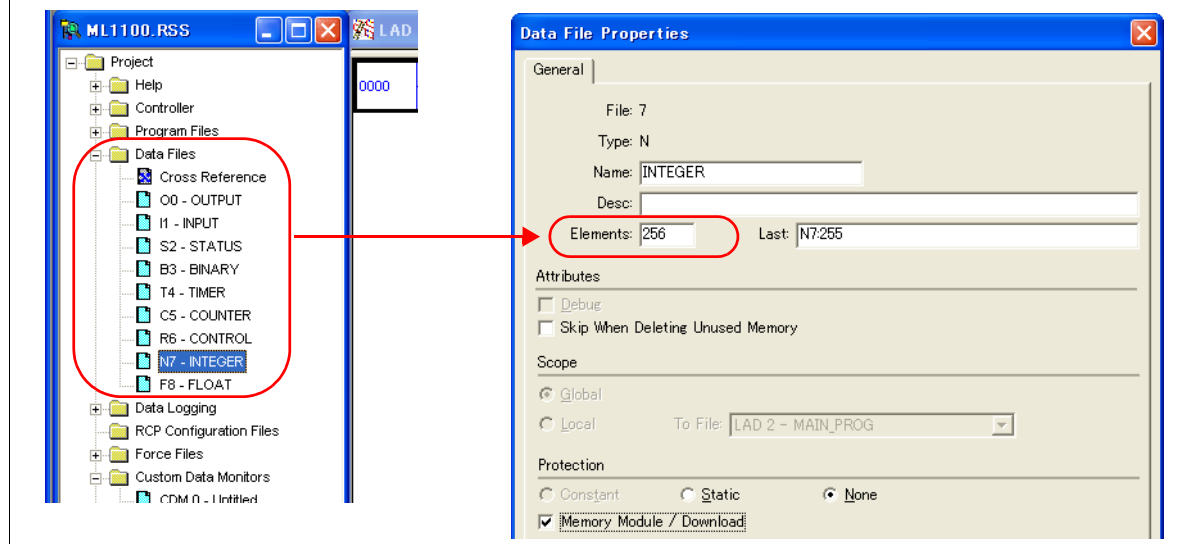

Address denotations

The assigned memory is indicated when editing the screen as shown below.

- Address other than input/output
- For word access

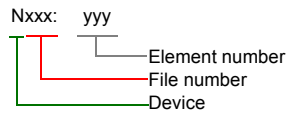

For bit access

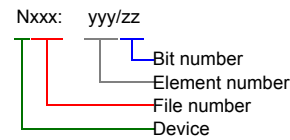

The file number will not be displayed for the input, output or status memory.

- Input/output address
- For word access

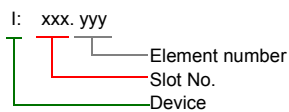

For bit access

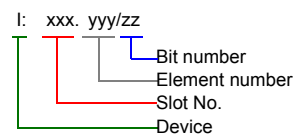

Indirect Memory Designation

- For the file or slot numbers 0 to 65:

	15	MSB	8	7	LSB	0
n + 0	Model			Memory type		
n + 1	Address No.					
n + 2	00		Bit designation			
n + 3	00		Station number			

- For the file or slot numbers 66 to 255:

	15	MSB	8	7	LSB	0
n + 0	Model			Memory type		
n + 1	Lower address No.					
n + 2	Higher address No.					
n + 3	00		Bit designation			
n + 4	00		Station number			

- Specify the file number or slot number and the element number for the address number.

Example: When specifying N007:123
Specify "7123" (DEC) for the address number.

Example: When specifying N120:123
Specify "120123" (DEC) for the address number.
120123 (DEC) is equivalent to 1D53B (HEX). Specify "D53B (HEX)" for the lower address number and "0001" for the upper address number.

- When specifying an address for the timer (control), counter (control) or control device in bit designation, specify the bit number in decimal notation as shown below:

- T: Timer (control)
DN = 13, TT = 14, EN = 15
- C: Counter (control)
UA = 10, UN = 11, OV = 12, DN = 13, CD = 14, CU = 15
- R: Control
FD = 08, IN = 09, UL = 10, ER = 11, EM = 12, DN = 13, EU = 14, EN = 15

2.1.8 Micro Logix (Ethernet TCP/IP)

Communication Setting

Editor

Make the following settings on the editor. For more information, see “Appendix 2 Ethernet”.

- IP address for the TS unit
 - When specified on the screen data:
[System Setting] → [Ethernet Communication] → [Local Port IP Address]
 - When specified on the TS unit:
Main Menu screen → [Ethernet]
- Port number for the TS unit (for communication with PLC)
[System Setting] → [Device Connection Setting] → [Communication Setting]
- IP address and port number (No. 44818) of the PLC
[System Setting] → [Device Connection Setting] → [PLC Table]

PLC

Channel 1

Channel Configuration (Channel 1)

The screenshot shows the 'Channel Configuration' dialog box for 'Channel 1'. The 'Driver' is set to 'Ethernet'. The 'Hardware Address' is 000F:7301:07:FD. The 'IP Address' is 10.91.131.188, 'Subnet Mask' is 255.255.255.0, and 'Gateway Address' is 10.91.131.1. The 'DHRIO Link ID' is 0. Under 'Protocol Control', 'HTTP Server Enable' and 'Auto Negotiate' are checked. 'Msg Connection Timeout (x 1mS)' is 15000 and 'Msg Reply Timeout (x 1mS)' is 3000. The 'Port Setting' is '10/100 Mbps Full Duplex/Half Duplex'. There are empty fields for 'Contact' and 'Location'.

Item	Setting	Remarks
Driver	Ethernet	
IP Address	PLC's IP address	
Subnet Mask	PLC's subnet mask	
Gateway Address	Make settings in accordance with the network environment.	

Calendar

This model is not equipped with the calendar function. Use the built-in clock of the TS series.

Available Memory

The available memory setting range varies depending on the PLC model. Be sure to set within the range available for the PLC. Use [TYPE] when assigning the indirect memory for macro programs.

Memory	TYPE	Remarks
N (integer)	00H	
B (bit)	01H	
T. ACC (timer/current value)	02H	
T. PRE (timer/set value)	03H	
C. ACC (counter/current value)	04H	
C. PRE (counter/set value)	05H	
I (input)	06H	
O (output)	07H	
S (status)	08H	
T (timer/control)	09H	
C (counter/control)	0AH	
R (control)	0BH	
R. LEN (control/data length)	0CH	
R. POS (control/data position)	0DH	
A (ASCII)	0FH	
F (FLOAT)	10H	Real number
ST (STRING)	11H	
L (LONG)	12H	Double-word

Make settings for "Data Files" using the ladder tool. Otherwise, "Error Code 10 00" is displayed on TS series. For more information, refer to the PLC manual issued by the manufacturer.

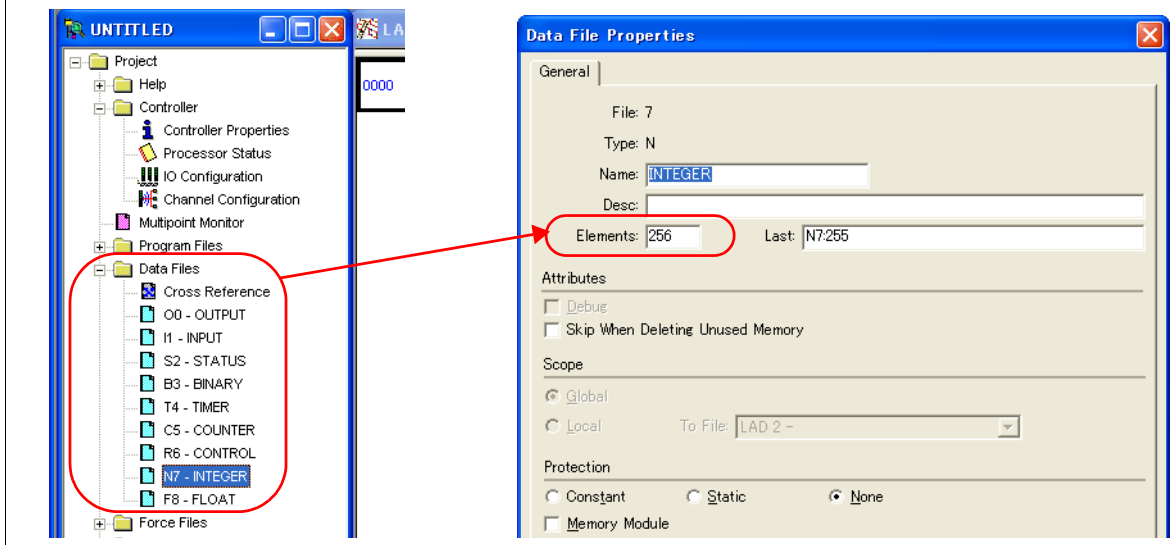

Address denotations

The assigned memory is indicated when editing the screen as shown below.

- Address other than input/output
- For word access

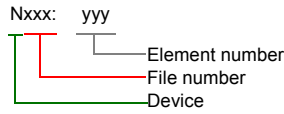

For bit access

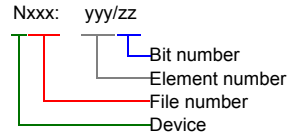

The file number will not be displayed for the input, output or status memory.

- Input/output address
- For word access

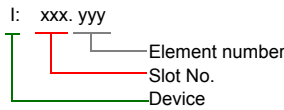

For bit access

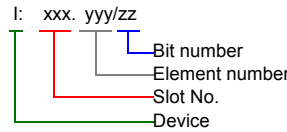

Indirect Memory Designation

- For the file or slot numbers 0 to 65:

	15	MSB	8	7	LSB	0
n + 0	Model			Memory type		
n + 1	Address No.					
n + 2	00		Bit designation			
n + 3	00		Station number			

- For the file or slot numbers 66 to 255:

	15	MSB	8	7	LSB	0
n + 0	Model			Memory type		
n + 1	Lower address No.					
n + 2	Higher address No.					
n + 3	00		Bit designation			
n + 4	00		Station number			

- Specify the file number or slot number and the element number for the address number.

Example: When specifying N007:123
Specify "7123" (DEC) for the address number.

Example: When specifying N120:123
Specify "120123" (DEC) for the address number.
120123 (DEC) is equivalent to 1D53B (HEX). Specify "D53B (HEX)" for the lower address number and "0001" for the upper address number.

- When specifying an address for the timer (control), counter (control) or control device in bit designation, specify the bit number in decimal notation as shown below:

- T: Timer (control)
DN = 13, TT = 14, EN = 15
- C: Counter (control)
UA = 10, UN = 11, OV = 12, DN = 13, CD = 14, CU = 15
- R: Control
FD = 08, IN = 09, UL = 10, ER = 11, EM = 12, DN = 13, EU = 14, EN = 15

2.1.9 NET-ENI (SLC500 Ethernet TCP/IP)

The TS series establishes communication with SLC500 via NET-ENI.

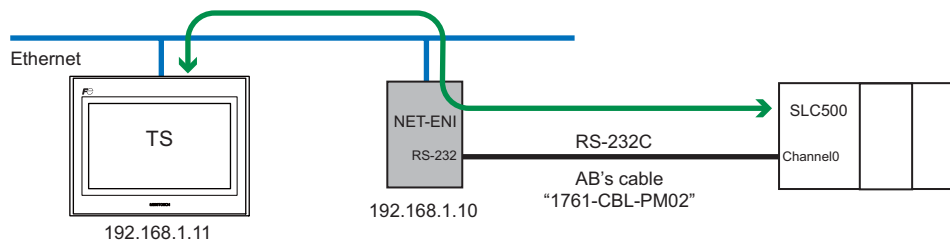

Communication Setting

Editor

Make the following settings on the editor. For more information, see "Appendix 2 Ethernet".

- IP address for the TS unit
 - When specified on the screen data:
[System Setting] → [Ethernet Communication] → [Local Port IP Address]
 - When specified on the TS unit:
Main Menu screen → [Ethernet]
- Port number for the TS unit (for communication with PLC)
[System Setting] → [Device Connection Setting] → [Communication Setting]
- IP address and port number (No. 44818) of the PLC
[System Setting] → [Device Connection Setting] → [PLC Table]

PLC

NET-ENI / NET-ENIW

ENI / ENIW Utility

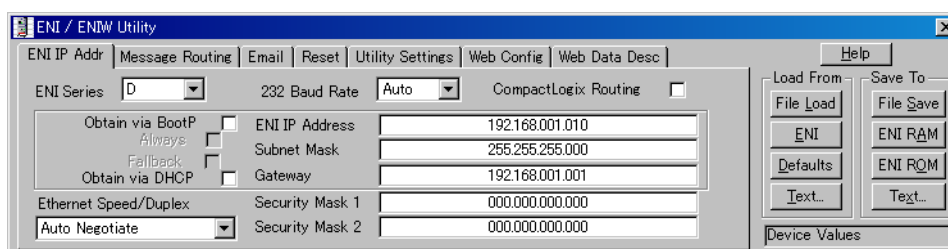

Item	Setting	Remarks
ENI IP Addr	232 Baud Rate	Auto
	ENI IP Address	Set the IP address of NET-ENI.
	Subnet Mask	Set the subnet mask of NET-ENI.
	Gateway	Make settings in accordance with the network environment.

Press [ENI RQM] to save the settings.

SLC500

Channel Configuration

Channel Configuration

General | Chan. 1 - System | **Chan. 0 - System** | Chan. 0 - User

Driver: DF1 Full Duplex | Source ID: 9 (decimal)

Baud: 19200

Parity: NONE

Stop Bits: 1

Protocol Control

Control Line: No Handshaking | ACK Timeout (x20 ms): 50

Error Detection: CRC

Embedded Responses: Auto Detect

Duplicate Packet Detect | NAK Retries: 3 | ENQ Retries: 3

	Item	Setting	Remarks
Chan. 0 - System	Driver	DF1 Full Duplex	
	Baud	9600 / 19200 / 38400	
	Parity	None	
	Stop Bits	1	
	Control Line	No Handshaking	
	Error Detection	CRC	
	Embedded Responses	Auto Detect	
	Duplicate Packet Detect	Checked	

Available Memory

The available memory setting range varies depending on the PLC model. Be sure to set within the range available for the PLC. Use [TYPE] when assigning the indirect memory for macro programs.

Memory	TYPE	Remarks
N (integer)	00H	
B (bit)	01H	
T. ACC (timer/current value)	02H	
T. PRE (timer/set value)	03H	
C. ACC (counter/current value)	04H	
C. PRE (counter/set value)	05H	
I (input)	06H	
O (output)	07H	
S (status)	08H	
T (timer/control)	09H	
C (counter/control)	0AH	
R (control)	0BH	
R. LEN (control/data length)	0CH	
R. POS (control/data position)	0DH	
A (ASCII)	0FH	
F (FLOAT)	10H	Real number
ST (STRING)	11H	

Make settings for "Data Files" using the ladder tool. Otherwise, "Error Code 10 00" is displayed on TS series. For more information, refer to the PLC manual issued by the manufacturer.

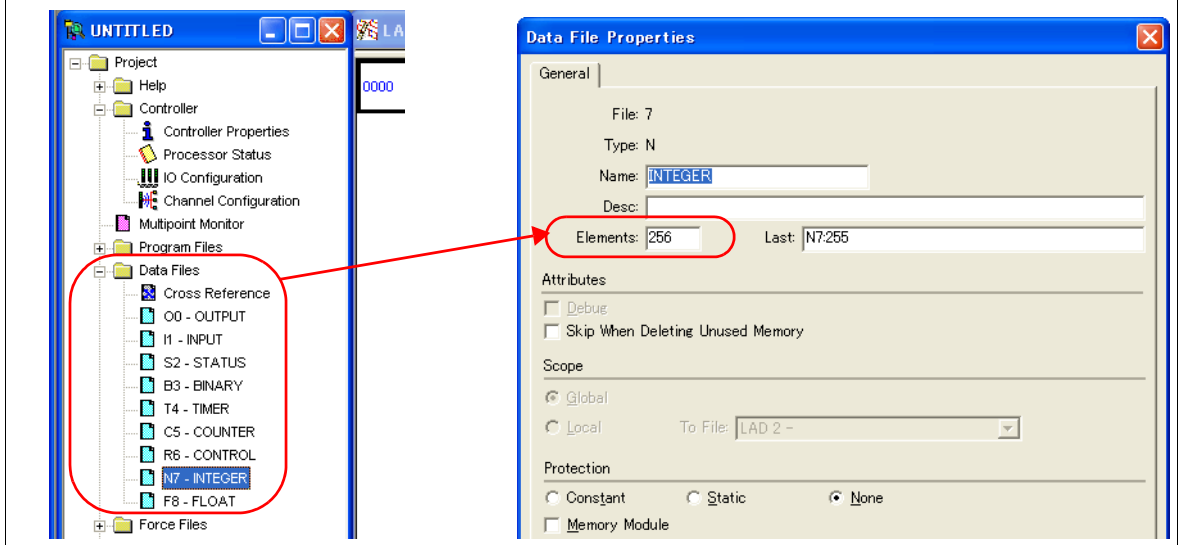

Address denotations

The assigned memory is indicated when editing the screen as shown below.

- Address other than input/output
- For word access

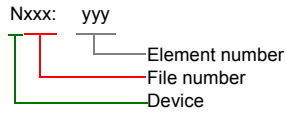

For bit access

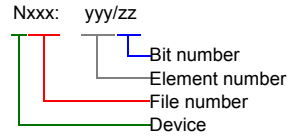

The file number will not be displayed for the input, output or status memory.

- Input/output address
- For word access

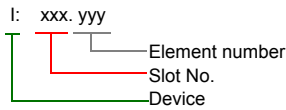

For bit access

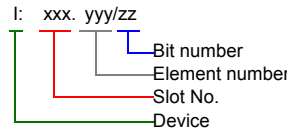

Indirect Memory Designation

- For the file or slot numbers 0 to 65:

	15	MSB	8	7	LSB	0
n + 0	Model			Memory type		
n + 1	Address No.					
n + 2	00		Bit designation			
n + 3	00		Station number			

- For the file or slot numbers 66 to 255:

	15	MSB	8	7	LSB	0
n + 0	Model			Memory type		
n + 1	Lower address No.					
n + 2	Higher address No.					
n + 3	00		Bit designation			
n + 4	00		Station number			

- Specify the file number or slot number and the element number for the address number.

Example: When specifying N007:123
Specify "7123" (DEC) for the address number.

Example: When specifying N120:123
Specify "120123" (DEC) for the address number.
120123 (DEC) is equivalent to 1D53B (HEX). Specify "D53B (HEX)" for the lower address number and "0001" for the upper address number.

- When specifying an address for the timer (control), counter (control) or control device in bit designation, specify the bit number in decimal notation as shown below:

- T: Timer (control)
DN = 13, TT = 14, EN = 15
- C: Counter (control)
UA = 10, UN = 11, OV = 12, DN = 13, CD = 14, CU = 15
- R: Control
FD = 08, IN = 09, UL = 10, ER = 11, EM = 12, DN = 13, EU = 14, EN = 15

2.1.10 NET-ENI (MicroLogix Ethernet TCP/IP)

The TS series establishes communication with MicroLogix via NET-ENI.

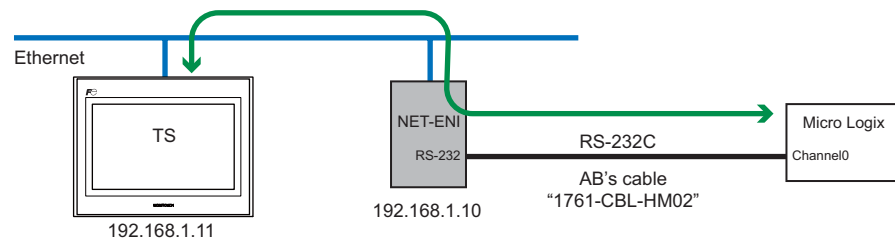

Communication Setting

Editor

Make the following settings on the editor. For more information, see "Appendix 2 Ethernet".

- IP address for the TS unit
 - When specified on the screen data:
[System Setting] → [Ethernet Communication] → [Local Port IP Address]
 - When specified on the TS unit:
Main Menu screen → [Ethernet]
- Port number for the TS unit (for communication with PLC)
[System Setting] → [Device Connection Setting] → [Communication Setting]
- IP address and port number (No. 44818) of the PLC
[System Setting] → [Device Connection Setting] → [PLC Table]

PLC

NET-ENI / NET-ENIW

ENI / ENIW Utility

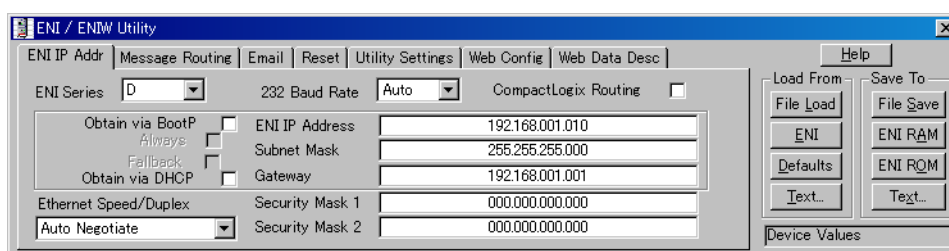

Item	Setting	Remarks
ENI IP Addr	232 Baud Rate	Auto
	ENI IP Address	Set the IP address of NET-ENI.
	Subnet Mask	Set the subnet mask of NET-ENI.
	Gateway	Make settings in accordance with the network environment.

Press [ENI RQM] to save the settings.

MicroLogix

Channel Configuration

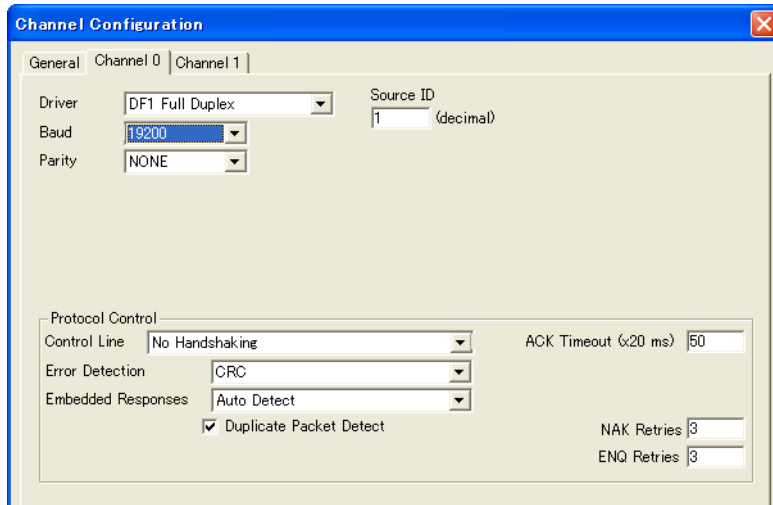

(Underlined setting: default)

Item		Setting	Remarks
Chan. 0	Driver	DF1 Full Duplex	
	Baud	4800 / 9600 / <u>19200</u> / 38.4K	
	Parity	None	
	Control Line	No Handshaking	
	Error Detection	CRC	
	Embedded Responses	Auto Detect	
	Duplicate Packet Detect	Checked	

Calendar

This model is not equipped with the calendar function. Use the built-in clock of the TS series.

Available Memory

The available memory setting range varies depending on the PLC model. Be sure to set within the range available for the PLC. Use [TYPE] when assigning the indirect memory for macro programs.

Memory	TYPE	Remarks
N (integer)	00H	
B (bit)	01H	
T. ACC (timer/current value)	02H	
T. PRE (timer/set value)	03H	
C. ACC (counter/current value)	04H	
C. PRE (counter/set value)	05H	
I (input)	06H	
O (output)	07H	
S (status)	08H	
T (timer/control)	09H	
C (counter/control)	0AH	
R (control)	0BH	
R. LEN (control/data length)	0CH	
R. POS (control/data position)	0DH	
A (ASCII)	0FH	
F (FLOAT)	10H	Real number
ST (STRING)	11H	
L (LONG)	12H	Double-word

Make settings for "Data Files" using the ladder tool. Otherwise, "Error Code 10 00" is displayed on TS series. For more information, refer to the PLC manual issued by the manufacturer.

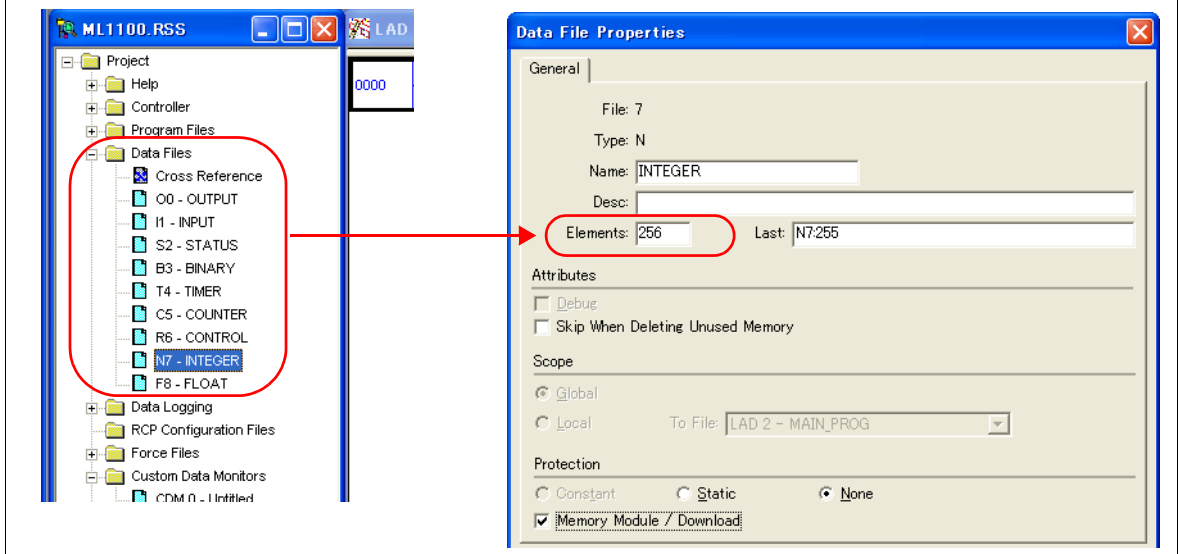

Address denotations

The assigned memory is indicated when editing the screen as shown below.

- Address other than input/output
- For word access

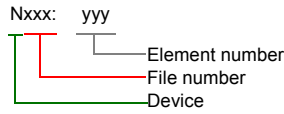

For bit access

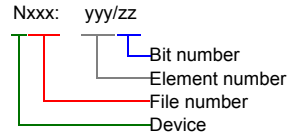

The file number will not be displayed for the input, output or status memory.

- Input/output address
- For word access

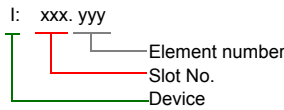

For bit access

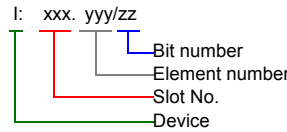

Indirect Memory Designation

- For the file or slot numbers 0 to 65:

	15	MSB	8	7	LSB	0
n + 0	Model			Memory type		
n + 1	Address No.					
n + 2	00		Bit designation			
n + 3	00		Station number			

- For the file or slot numbers 66 to 255:

	15	MSB	8	7	LSB	0
n + 0	Model			Memory type		
n + 1	Lower address No.					
n + 2	Higher address No.					
n + 3	00		Bit designation			
n + 4	00		Station number			

- Specify the file number or slot number and the element number for the address number.

Example: When specifying N007:123
Specify "7123" (DEC) for the address number.

Example: When specifying N120:123
Specify "120123" (DEC) for the address number.
120123 (DEC) is equivalent to 1D53B (HEX). Specify "D53B (HEX)" for the lower address number and "0001" for the upper address number.

- When specifying an address for the timer (control), counter (control) or control device in bit designation, specify the bit number in decimal notation as shown below:

- T: Timer (control)
DN = 13, TT = 14, EN = 15
- C: Counter (control)
UA = 10, UN = 11, OV = 12, DN = 13, CD = 14, CU = 15
- R: Control
FD = 08, IN = 09, UL = 10, ER = 11, EM = 12, DN = 13, EU = 14, EN = 15

2.1.11 Wiring Diagrams

When Connected at COM1:

RS-422

Wiring diagram 1 - COM1

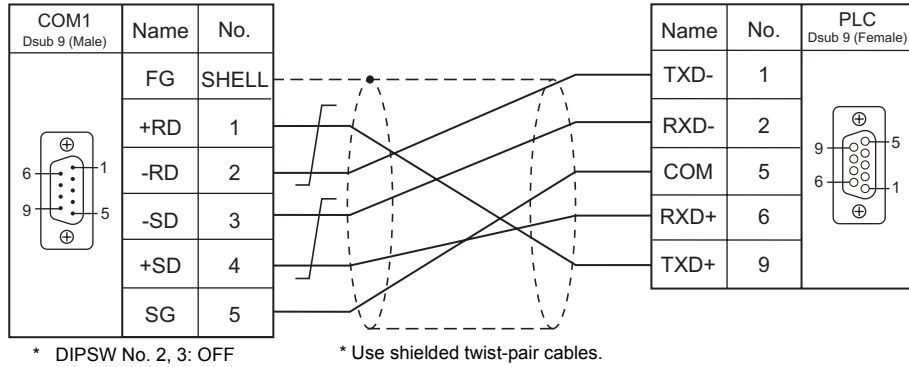

Wiring diagram 2 - COM1

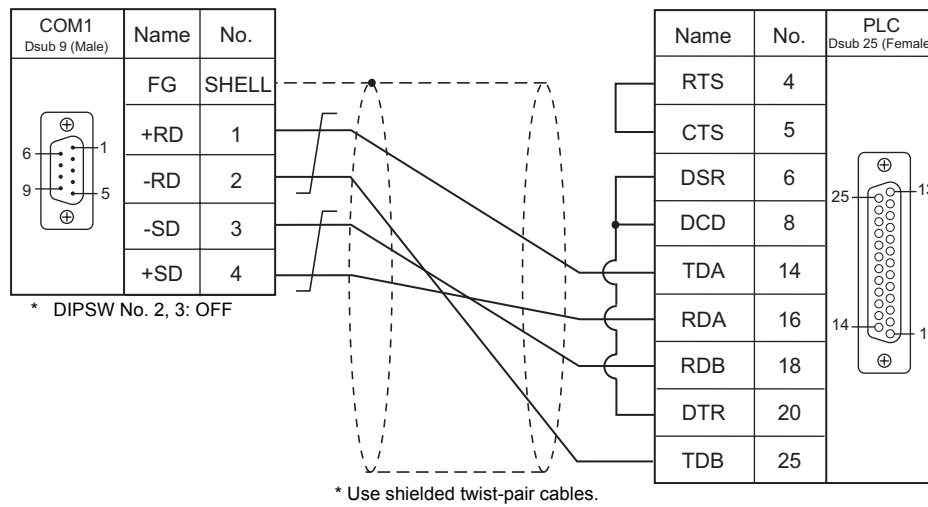

Wiring diagram 3 - COM1

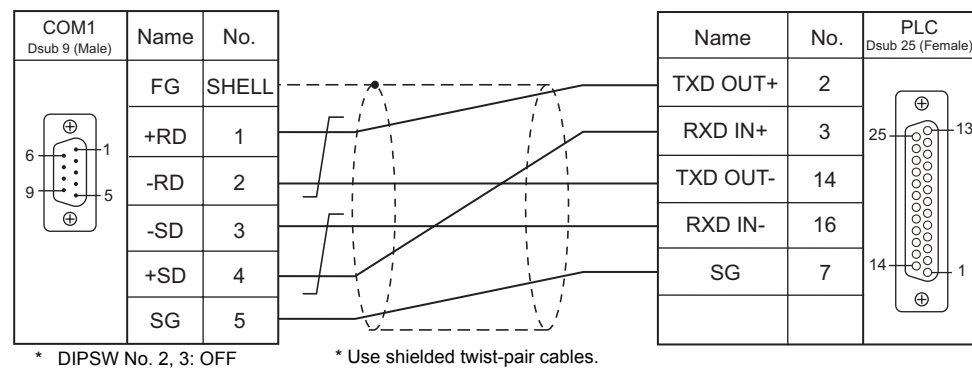

When Connected at COM2:

RS-232C

Wiring diagram 1 - COM2

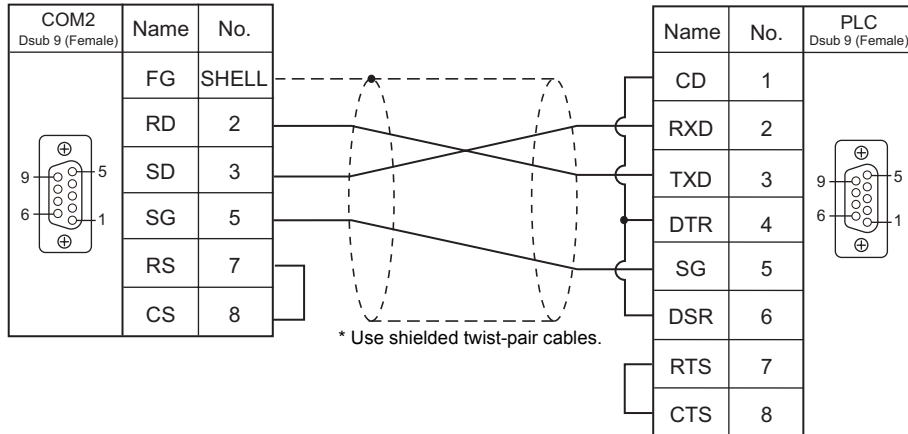

Wiring diagram 2 - COM2

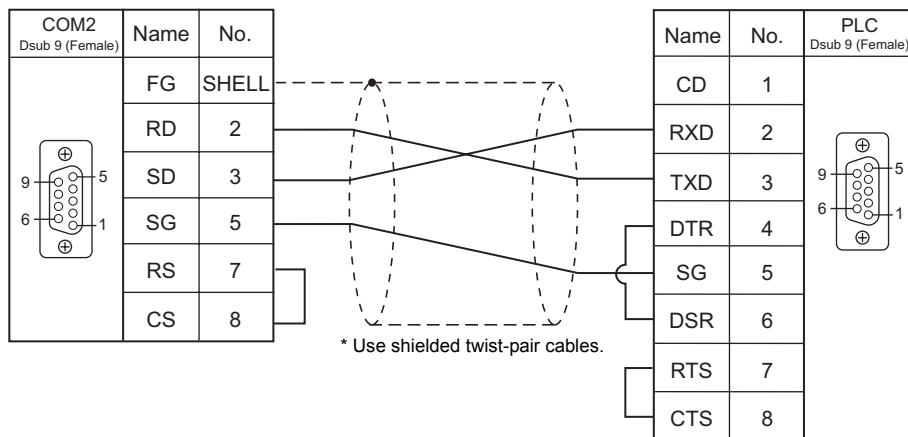

Wiring diagram 3 - COM2

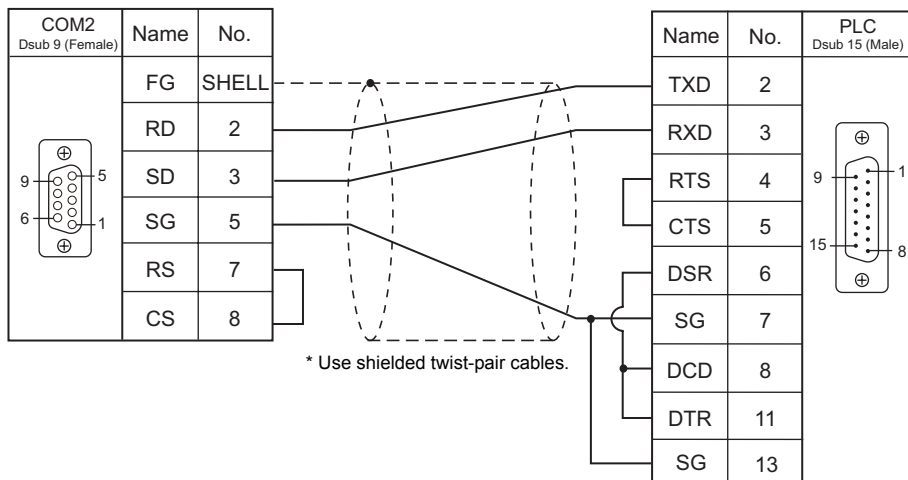

Wiring diagram 4 - COM2

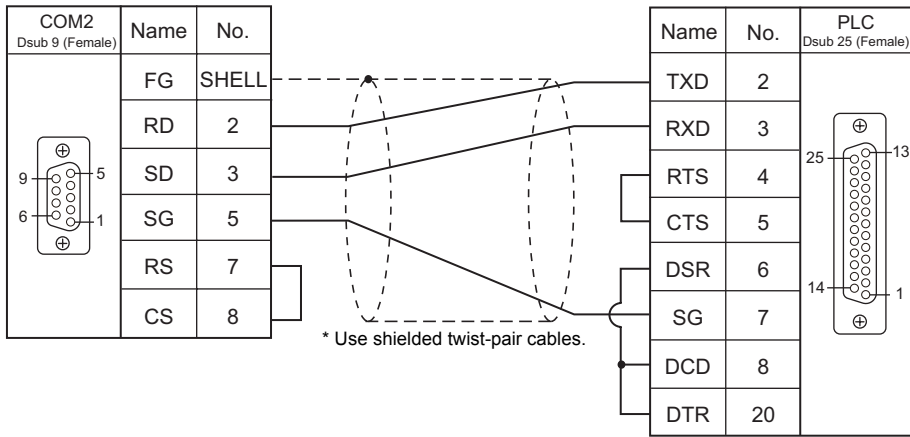

Wiring diagram 5 - COM2

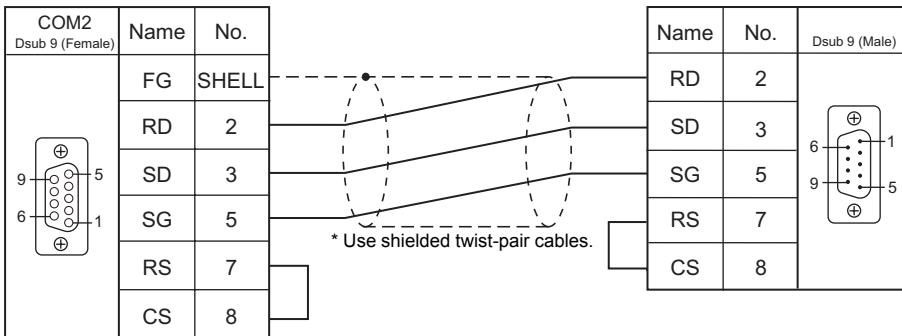

MEMO

Please use this page freely.

3. Automationdirect

3.1 PLC Connection

3.1 PLC Connection

Serial Connection

PLC Selection on the Editor	PLC	Port	Signal Level	TS Port	Connection	Ladder Transfer *1
Direct LOGIC (K-Sequence)	D4-430 D4-440	Port 0	RS-232C	COM2	Wiring diagram 4 - COM2	×
		Port 1	RS-232C	COM2	Wiring diagram 1 - COM2	
			RS-422	COM1	Wiring diagram 1 - COM1	
	D4-450	Port 0	RS-232C	COM2	Wiring diagram 4 - COM2	
		Port 1	RS-232C	COM2	Wiring diagram 1 - COM2	
			RS-422	COM1	Wiring diagram 1 - COM1	
		Port 2	RS-232C	COM2	Wiring diagram 3 - COM2	
		Port 3	RS-422	COM1	Wiring diagram 2 - COM1	
	D2-230	PORT1	RS-232C	COM2	Wiring diagram 3 - COM2	
	D2-240 DL05	PORT1				
		PORT2				
	D2-250-1 D2-260 DL06	PORT1	RS-232C	COM2	Wiring diagram 2 - COM2	
PORT2		RS-422			COM1	Wiring diagram 3 - COM1
Direct LOGIC (MODBUS RTU)	D4-450	Port 1	RS-232C	COM2	Wiring diagram 1 - COM2	
			RS-422	COM1	Wiring diagram 1 - COM1	
		Port 3	RS-422	COM1	Wiring diagram 2 - COM1	
	D2-250-1 D2-260	PORT2	RS-232C	COM2	Wiring diagram 2 - COM2	
			RS-422	COM1	Wiring diagram 3 - COM1	

*1 For the ladder transfer function, see "Appendix 5 Ladder Transfer Function".

Ethernet Connection

PLC Selection on the Editor	CPU	Unit	TCP/IP	UDP/IP	Port No.	Ladder Transfer *1
Direct LOGIC (Ethernet UDP/IP)	DL05 DL06	H0-ECOM H0-ECOM100	×	○	28784 (fixed)	×
	D2-240 D2-250-1 D2-260	H2-ECOM H2-ECOM100				

*1 For the ladder transfer function, see "Appendix 5 Ladder Transfer Function".

3.1.1 Direct LOGIC (K-Sequence)

Communication Setting

Editor

Communication setting

(Underlined setting: default)

Item	Setting	Remarks
Connection Mode	<u>1</u> : 1 / Multi-link2	
Signal Level	<u>RS-232C</u> / RS-422/485	
Baud Rate	4800 / 9600 / <u>19200</u> / 38400 bps	
Data Length	8 bits	
Stop Bit	<u>1</u> / 2 bits	
Parity	None / <u>Odd</u> / Even	
Target Port No.	0 to 31	

D4-450

PORT0

No particular setting is necessary on the PLC. The PLC always performs communication functions using the following parameters. Set the following parameters on the [Communication Setting] tab window of the editor.

Item	Setting	Remarks
Baud Rate	9600 bps	
Parity	Odd	
Data Length	8	
Stop Bit	1	
Data Type	HEX	

PORT1

Set parameters into the special register "R772, 773", then set "AA5A" (HEX) into the setting complete register "R767". When the set value at R767 is changed to "AAAA" (HEX), it is regarded as normal; if it is changed to "AAEA" (HEX), it is regarded as erroneous.

Parameter setting register

(Underlined setting: default)

Register	Setting	Setting Example
R772	<p>0 0 <u>E</u> 0</p> <p>Communication protocol 80: K-Sequence <u>EQ</u>: Automatic recognition (Modbus, CCM, K-Sequence)</p> <p>Communication timeout 0: 800 ms</p> <p>Response delay time 0: 0 ms</p>	<p>00E0H K-Sequence</p>

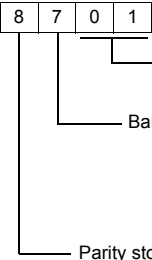
Register	Setting	Setting Example
R773	 <p>Station number 01 to 1F (HEX)</p> <p>Baud rate 4: 4800 bps 5: 9600 bps 6: 19200 bps 7: 38400 bps</p> <p>Parity stop bit 0: Without parity, stop bit 1 2: Without parity, stop bit 2 8: <u>Odd parity, stop bit 1</u> A: Odd parity, stop bit 2 C: Even parity, stop bit 1 E: Even parity, stop bit 2</p>	<p>8701H</p> <p>38400 bps Odd parity Stop bit 1 Station number 01</p>

PORT2

Set parameters into the special register "R774, 775", then set "A5AA" (HEX) into the setting complete register "R767". When the set value at R767 is changed to "AAAA" (HEX), it is regarded as normal; if it is changed to "AEAA" (HEX), it is regarded as erroneous.

Parameter setting register

Register	Setting	Setting Example
R774	Same as the setting register R772 for PORT1	00E0H
R775	Same as the setting register R773 for PORT1	8701H

PORT3

Set parameters into the special register "R776, 777", then set "5AAA" (HEX) into the setting complete register "R767". When the set value at R767 is changed to "AAAA" (HEX), it is regarded as normal; if it is changed to "EAAA" (HEX), it is regarded as erroneous.

Parameter setting register

Register	Setting	Setting Example
R776	Same as the setting register R772 for PORT1	00E0H
R777	Same as the setting register R773 for PORT1	8701H

D2-240/D2-250-1**PORT1 / PORT2**

No particular setting is necessary on the PLC. The PLC performs communication functions using the following parameters. Set the following parameters on the [Communication Setting] tab window of TS.

Item	Setting	Remarks
Baud Rate	9600 bps	For PORT2: 19200 bps can be set in the special register.
Parity	Odd	
Data Length	8	
Stop Bit	1	
Data Type	HEX	

Available Memory

The available memory setting range varies depending on the PLC model. Be sure to set within the range available for the PLC. Use [TYPE] when assigning the indirect memory for macro programs.

Memory	TYPE	Remarks
V (data register)	00H	
X (input)	01H	
Y (output)	02H	
C (internal relay)	03H	
S (stage)	04H	
GX (transmission relay for all stations)	05H	
GY (transmission relay for specified station)	06H	
T (timer/contact)	07H	
CT (counter/contact)	08H	

3.1.2 Direct LOGIC (Ethernet UDP/IP)

Communication Setting

Editor

Make the following settings on the editor. For more information, see Appendix 2 Ethernet.

- IP address for the TS unit
 - When specified on the screen data:
[System Setting] → [Ethernet Communication] → [Local Port IP Address]
 - When specified on the TS unit:
Main Menu screen → [Ethernet]
- Port number for the TS unit (for communication with PLC)
[System Setting] → [Device Connection Setting] → [Communication Setting]
- Others
[System Setting] → [Device Connection Setting] → [Communication Setting]
 - For [Transfer Speed], select the same setting as the specification of the connected communication module.*
For Hx-ECOM: 10BASE-T
For Hx-ECOM100: 100BASE-TX
 - * If the transfer speed is not selected correctly, a check code error occurs.

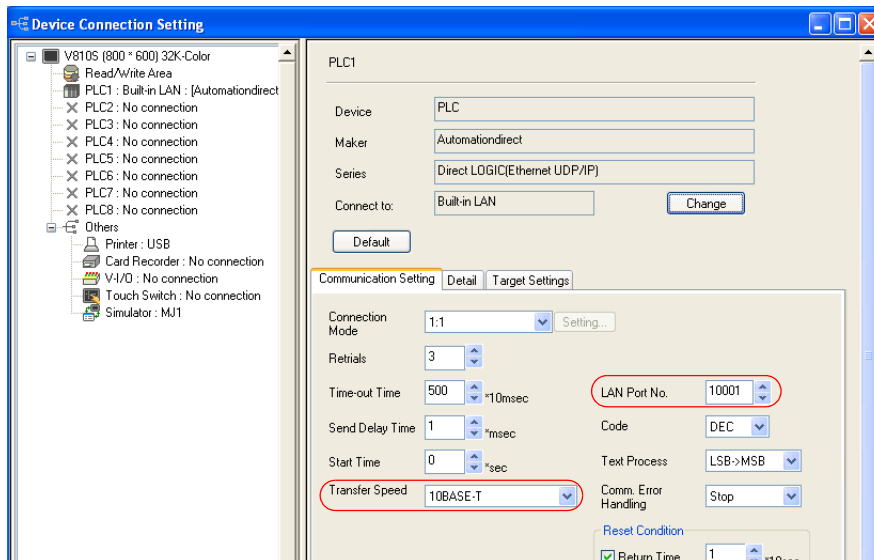

- IP address and port number of the PLC
[System Setting] → [Device Connection Setting] → [PLC Table]

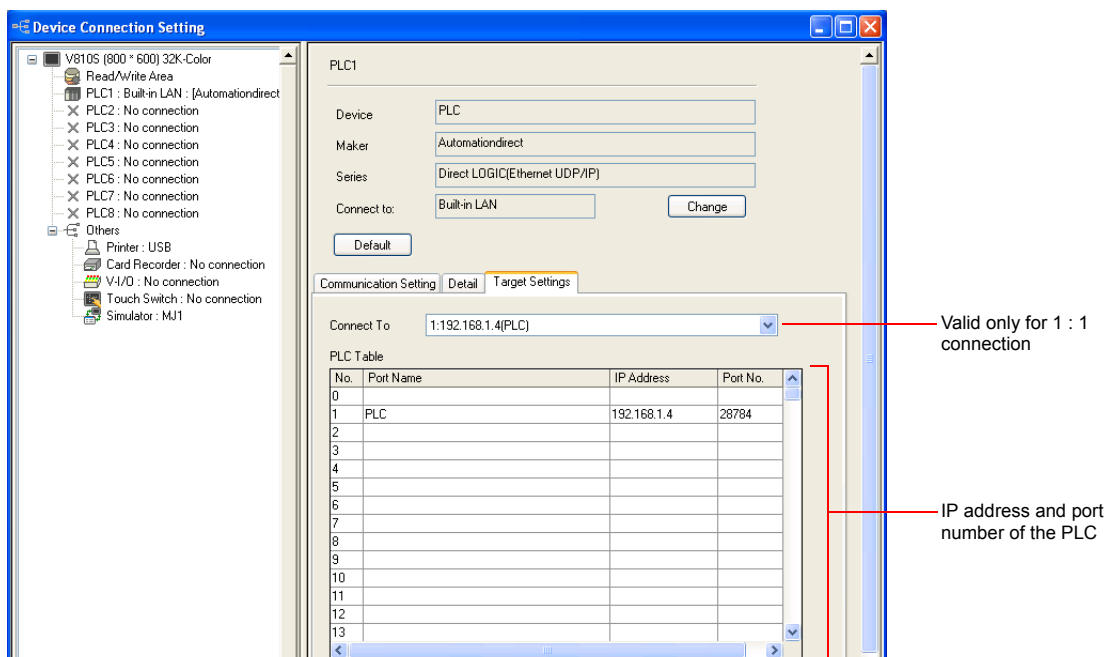

DirectLOGIC/SU Series

Make PLC settings by using the software "DirectSOFT". For more information, refer to the PLC manual issued by the manufacturer.

Link wizard

Contents	Setting	Remarks
Transport Protocol	UDP/IP	
Module ID	Make settings in accordance with the network environment.	"0" cannot be set. Set all DIP switches on Hx-ECOM to the OFF positions.
IP Address		

* The port number is fixed to "28784".

* The module ID or IP address can also be set by using the Hx-ECOM configuration software "NetEdit3" or HTML of the module (only for Hx-ECOM100). For more information, refer to the PLC manual issued by the manufacturer.

DIP switch

The module ID can be set by the DIP switch.

When any of the DIP switches is set in the ON position upon power-on, the module ID set by the DIP switch will take effect.

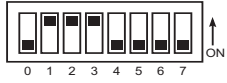
DIP Switch	Setting Example	Remarks
	$14 (= 2^1 + 2^2 + 2^3)$	Setting range: 1 to 63 Set the value in binary notation by referring to the figures printed on the PCB. Note that the DIP switches 6 and 7 are not used.

Available Memory

The available memory setting range varies depending on the PLC model. Be sure to set within the range available for the PLC. Use [TYPE] when assigning the indirect memory for macro programs.

Memory	TYPE	Remarks
V (data register)	00H	
X (input)	01H	
Y (output)	02H	
C (internal relay)	03H	
S (stage)	04H	
GX (transmission relay for all stations)	05H	
GY (transmission relay for specified station)	06H	
T (timer/contact)	07H	
CT (counter/contact)	08H	

3.1.3 Direct LOGIC (MODBUS RTU)

Communication Setting

Editor

Communication setting

(Underlined setting: default)

Item	Setting	Remarks
Connection Mode	<u>1</u> : 1 / 1 : n / Multi-link2	
Signal Level	<u>RS-232C</u> / RS-422/485	
Baud Rate	4800 / 9600 / <u>19200</u> / 38400 bps	
Data Length	8 bits	
Stop Bit	<u>1</u> / 2 bits	
Parity	None / Odd / Even	
Target Port No.	1	

D4-450

PORT1

Set parameters into the special register "R772, 773", then set "AA5A" (HEX) into the setting complete register "R767". When the set value at R767 is changed to "AAAA" (HEX), it is regarded as normal; if it is changed to "AAEA" (HEX), it is regarded as erroneous.

Parameter setting register

(Underlined setting: default)

Register	Setting	Setting Example
R772	<p> Communication protocol 20: MODBUS RTU <u>E0</u>: Automatic recognition (Modbus, CCM, K-Sequence) </p> <p> Communication timeout 0: 800 ms </p> <p> Response delay time 0: 0 ms </p>	00E0H
R773	<p> Station number 01 to 1F (HEX) </p> <p> Baud rate 4: 4800 bps 5: 9600 bps <u>6</u>: 19200 bps 7: 38400 bps </p> <p> Parity stop bit 0: Without parity, stop bit 1 2: Without parity, stop bit 2 <u>8</u>: <u>Odd parity, stop bit 1</u> A: Odd parity, stop bit 2 C: Even parity, stop bit 1 E: Even parity, stop bit 2 </p>	8701H 38400 bps Odd parity Stop bit 1 Station number 01

PORT3

Set parameters into the special register "R776, 777", then set "5AAA" (HEX) into the setting complete register "R767". When the set value at R767 is changed to "AAAA" (HEX), it is regarded as normal; if it is changed to "EAAA" (HEX), it is regarded as erroneous.

Parameter setting register

Register	Setting	Setting Example
R776	Same as the setting register R772 for PORT1	00E0H
R777	Same as the setting register R773 for PORT1	8701H

D2-250-1

PORT2

Set parameters into the special register "R7655, 7656", then set "0500" (HEX) into the setting complete register "R7657". When the set value at R7657 is changed to "0A00" (HEX), it is regarded as normal; if it is changed to "0E00" (HEX), it is regarded as erroneous.

Parameter setting register

(Underlined setting: default)

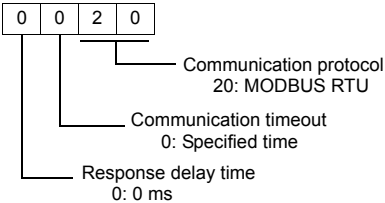
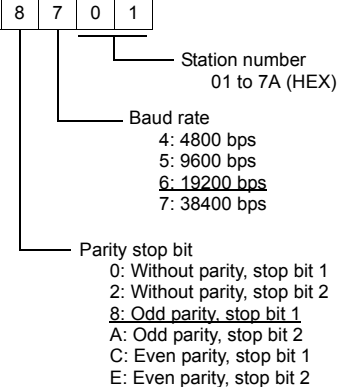
Register	Setting	Setting Example
R7655	 <p>0 0 2 0</p> <p>Communication protocol 20: MODBUS RTU</p> <p>Communication timeout 0: Specified time</p> <p>Response delay time 0: 0 ms</p>	0020H
R7656	 <p>8 7 0 1</p> <p>Station number 01 to 7A (HEX)</p> <p>Baud rate 4: 4800 bps 5: 9600 bps <u>6: 19200 bps</u> 7: 38400 bps</p> <p>Parity stop bit 0: Without parity, stop bit 1 2: Without parity, stop bit 2 <u>8: Odd parity, stop bit 1</u> A: Odd parity, stop bit 2 C: Even parity, stop bit 1 E: Even parity, stop bit 2</p>	8701H 38400 bps Odd parity Stop bit 1 Station number 01

Available Memory

The available memory setting range varies depending on the PLC model. Be sure to set within the range available for the PLC. Use [TYPE] when assigning the indirect memory for macro programs.

Memory	TYPE	Remarks
V (data register)	00H	
X (input)	01H	
Y (output)	02H	
C (internal relay)	03H	
S (stage)	04H	
GX (transmission relay for all stations)	05H	
GY (transmission relay for specified station)	06H	
T (timer/contact)	07H	
CT (counter/contact)	08H	

3.1.4 Wiring Diagrams

When Connected at COM1:

RS-422

Wiring diagram 1 - COM1

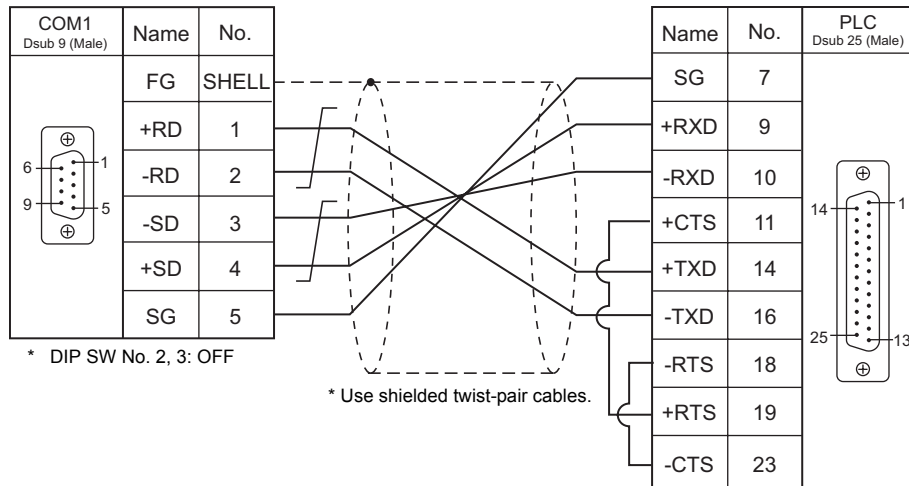

Wiring diagram 2 - COM1

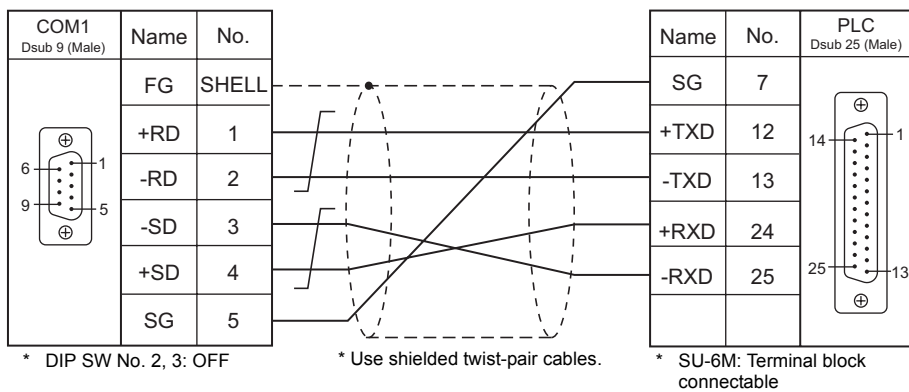

Wiring diagram 3 - COM1

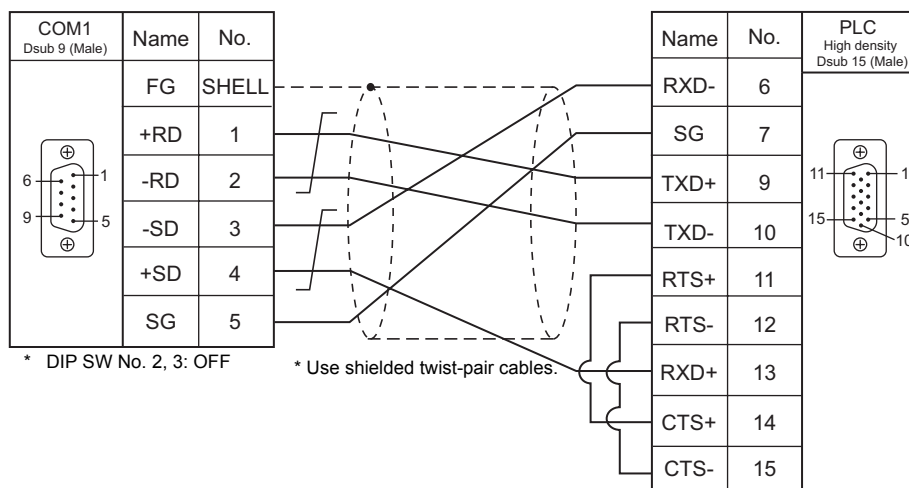

When Connected at COM2:

RS-232C

Wiring diagram 1 - COM2

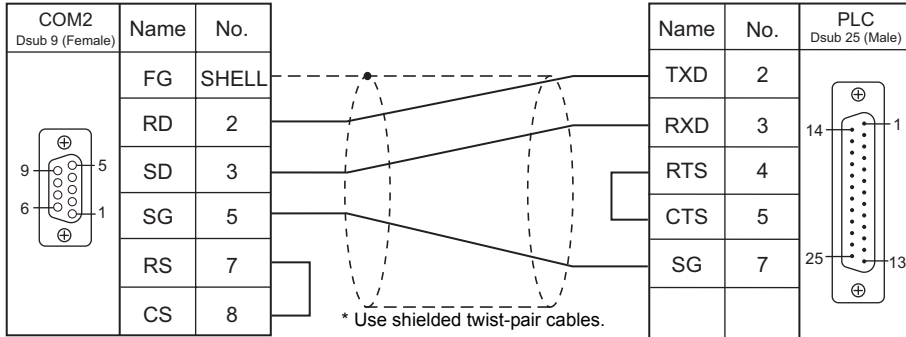

Wiring diagram 2 - COM2

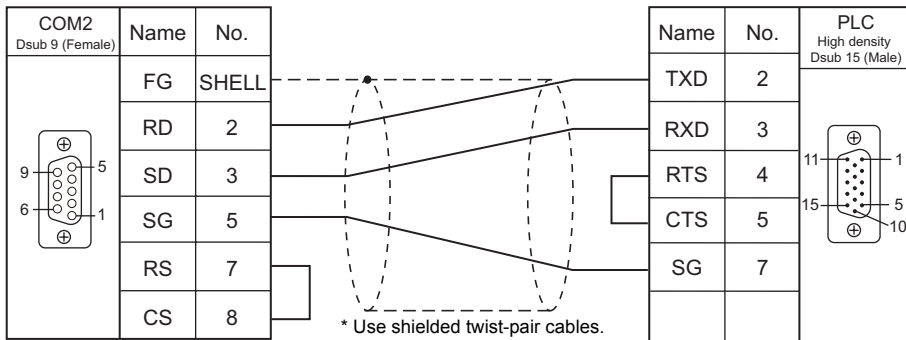

Wiring diagram 3 - COM2

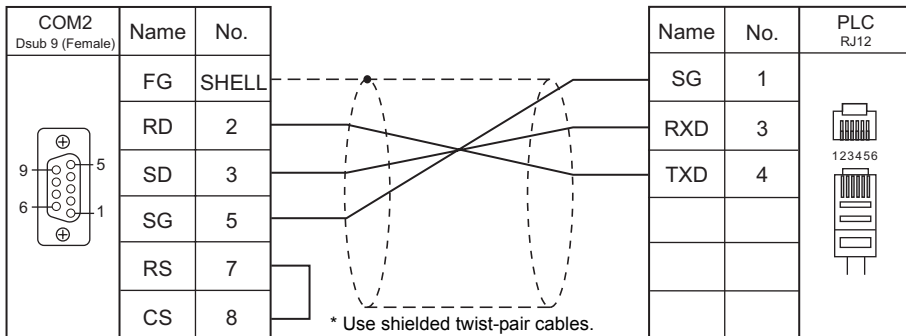

Wiring diagram 4 - COM2

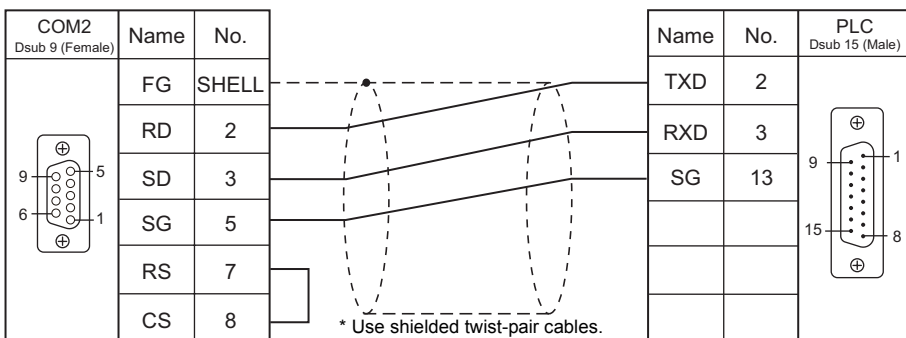

4. Baumuller

4.1 PLC Connection

4.1 PLC Connection

Serial Connection

PLC Selection on the Editor	CPU	Unit/Port	Signal Level	TS Port	Connection	Ladder Transfer *1
BMx-x-PLC	BMx-x-PLC	RS-422 port	RS-422	COM1	Wiring diagram 1 - COM1	×
		RS-232C port	RS-232C	COM2	Wiring diagram 1 - COM2	

*1 For the ladder transfer function, see "Appendix 5 Ladder Transfer Function".

4.1.1 BMx-x-PLC

Communication Setting

Editor

Communication setting

(Underlined setting: default)

Item	Setting	Remarks
Connection Mode	<u>1</u> :1 / Multi-link2	
Signal Level	RS-232C / <u>RS-422/485</u>	
Baud Rate	4800 / 9600 / <u>19200</u> / 38400 bps	
Data Length	<u>8</u> bits	
Stop Bit	<u>1</u> bit	
Parity	<u>Even</u>	

PLC

No particular setting is necessary on the PLC.

Available Memory

The available memory setting range varies depending on the PLC model. Be sure to set within the range available for the PLC. Use [TYPE] when assigning the indirect memory for macro programs.

Memory	TYPE	Remarks
DB (Data Block)	00H	

* The assigned memory is indicated when editing the screen as shown on the right.

Example: DB xxx yyy

↑ 0 to 255 (decimal)
↑ 0 to 255 (decimal)

4.1.2 Wiring Diagrams

When Connected at COM1:

RS-422

Wiring diagram 1 - COM1

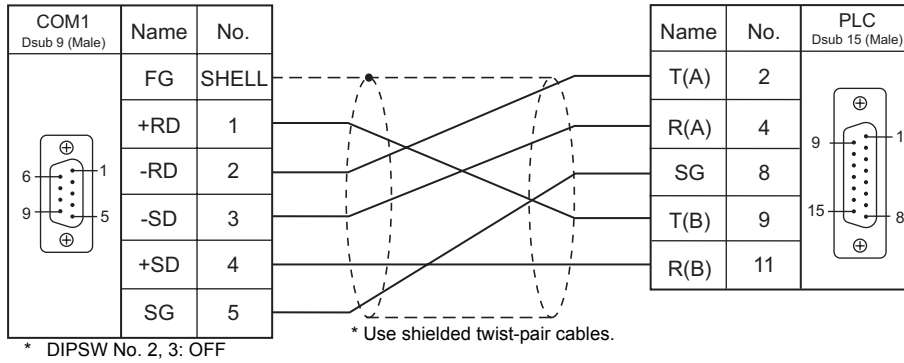

When Connected at COM2:

RS-232C

Wiring diagram 1 - COM2

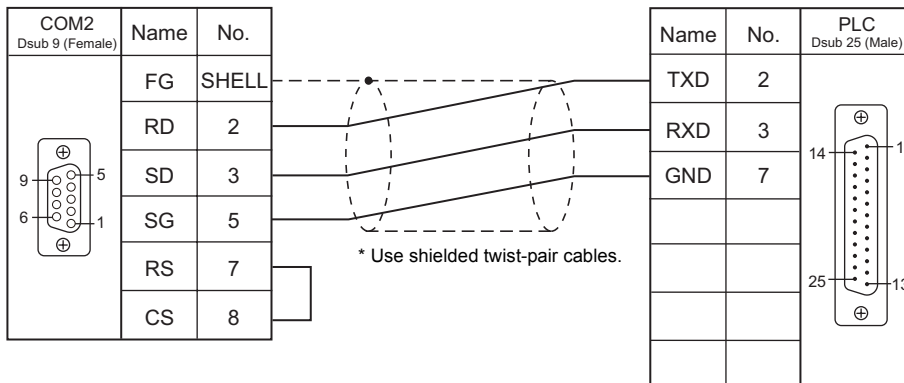

MEMO

Please use this page freely.

5. BECKHOFF

5.1 PLC Connection

5.1 PLC Connection

Ethernet Connection

PLC Selection on the Editor	CPU	Unit	LAN port	TCP/IP	UDP/IP	Port No.	Ladder Transfer *1
ADS protocol (Ethernet)	BC9000 BC9100 BX9000	KLxxxx *2	CPU (built-in)	○	×	48898 fixed	×

*1 For the ladder transfer function, see "Appendix 5 Ladder Transfer Function".

*2 Use the same voltage (24 V) as for the CPU.

5.1.1 ADS Protocol (Ethernet)

Communication Setting

Editor

Communication setting

Make the following settings on the editor. For more information, see “Appendix 2 Ethernet”.

- IP address for the TS unit
 - When specified on the screen data:
[System Setting] → [Ethernet Communication] → [Local Port IP Address]
 - When specified on the TS unit
Main Menu screen → [Ethernet]
- Port number for the TS unit (for communication with PLC)
[System Setting] → [Device Connection Setting] → [Communication Setting]
- IP address and port number of the PLC
[System Setting] → [Device Connection Setting] → [PLC Table]

PLC

IP address setting

1. Set the DIP switches 9 and 10 to OFF.
2. Connect the PLC with the computer.
3. Launch “Command Prompt” on the computer.
4. Enter “Arp -a” and execute it.
The IP address (xxx.xxx.xxx.xxx) and the MAC address (zzz.zzz.zzz.zzz) of the PLC previously set are displayed.
(Check whether you can ping the IP address of the PLC (“ping xxx.xxx.xxx.xxx”) successfully.)
5. Enter “Arp -d xxx.xxx.xxx.xxx” (IP address displayed in step 4.) and execute.
6. Enter “Arp -s yyy.yyy.yyy.yyy zzz.zzz.zzz.zzz” (new IP address and MAC address) and execute.
7. Enter “ping -l 123 yyy.yyy.yyy.yyy” (new IP address) and execute it. The new IP address becomes valid.

Port No.

TCP/IP port No. 48898 (fixed)

Available Memory

The available memory setting range varies depending on the PLC model. Be sure to set within the range available for the PLC. Use [TYPE] when assigning the indirect memory for macro programs.

Memory		TYPE	Remarks
P100-0	Port 100 - Index group 0	00H	
P300-I	Port 300 - Inputs	01H	Read only *1
P300-O	Port 300 - Outputs	02H	Write only *1
P800-I	Port 800 - Inputs	03H	*1
P800-O	Port 800 - Outputs	04H	*1
P800-F	Port 800 - Flags	05H	*1
P801-I	Port 801 - Inputs	06H	*1
P801-O	Port 801 - Outputs	07H	*1
P801-F	Port 801 - Flags	08H	*1

* Access to the memory area is not allowed if a password is set for the area.

*1 The addresses are expressed in "bytes". For word designation, specify an even-numbered address.

Address denotations

The assigned memory is indicated when editing the screen as shown below.

Example: P800 - F00000001

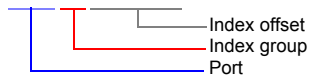

Indirect Memory Designation

For P300 / P800 / P801 device:

Specify a value obtained by dividing the address by 2. (Discard the fraction.)

Example: With indirect memory designation, "9" is assigned for "P300-I00000013".

13 (HEX) = 19 (DEC)

$19 \div 2 = 9.5$

PLC_CTL

Macro command "PLC_CTL F0 F1 F2"

Contents	F0	F1 (= \$u n)		F2
Access Inputs	1 - 8 (PLC1 - 8)	n	Station number	7
		n + 1	Command: 0001H	
		n + 2	Port *1	
		n + 3	Index Group *2	
		n + 4		
		n + 5	Index Offset *2	
		n + 6		
n + 7	Data			
Access Outputs	1 - 8 (PLC1 - 8)	n	Station number	8
		n + 1	Command: 0002H	
		n + 2	Port *1	
		n + 3	Index Group *2	
		n + 4		
		n + 5	Index Offset *2	
		n + 6		
n + 7	Data			

Return data: Data stored from temperature controller to TS series

*1 Port setting values

Port	Name
100	Logger (only NT - Log)
110	Eventlogger
300	IO
301	Additional Task 1
302	Additional Task 2
801	PLC Run-time System 1
811	PLC Run-time System 2
821	PLC Run-time System 3
831	PLC Run-time System 4
900	Camshaft Controller
10000	System Service
14000	Scope

*2 Setting values for "Index Group" and "Index Offset"

Access		Index Group	Index Offset	Description
Input	Output			
<input type="radio"/>	<input type="radio"/>	00004020H	0 - 65535	READ_M / WRITE_M
<input type="radio"/>	<input checked="" type="radio"/>	00004025H	0	PLCADS_IGR_RMSIZE
<input type="radio"/>	<input type="radio"/>	0000F003H	0	GET_SYMHANDLE_BYNAME
<input type="radio"/>	<input type="radio"/>	0000F005H	0 - 4294967295	READ_SYMVAL_BYHANDLE WRITE_SYMVAL_BYHANDLE
<input checked="" type="radio"/>	<input type="radio"/>	0000F006H	0	RELEASE_SYMHANDLE
<input type="radio"/>	<input type="radio"/>	0000F020H	0 - 4294967295	READ_I / WRITE_I
<input type="radio"/>	<input checked="" type="radio"/>	0000F025H	0	ADSIGRP_IOIMAGE_RISIZE
<input type="radio"/>	<input type="radio"/>	0000F030H	0 - 4294967295	READ_Q / WRITE_Q
<input type="radio"/>	<input checked="" type="radio"/>	0000F035H	0	ADSIGRP_IOIMAGE_ROSIZE

6. CHINO

6.1 Temperature Controller/Servo/Inverter Connection

6.1 Temperature Controller/Servo/Inverter Connection

Digital Temperature Controller

PLC Selection on the Editor	Model	Port		Signal Level	TS Port	Connection	Lst File	
DP1000	DP1xxxBRxx	Terminal block		RS-232C	COM2	Wiring diagram 1 - COM2	DP1000.Lst	
	DP1xxxBAxx	Terminal block		RS-422	COM1	Wiring diagram 1 - COM1		
	DP10xxGRxx-xxx	Terminal block	COM1	RS-232C	COM2	Wiring diagram 1 - COM2		
	DP10xxGSxx-xxx	Terminal block	COM1	RS-485	COM1	Wiring diagram 2 - COM1		
					COM3	Wiring diagram 1 - COM3		
	DP10xxGAxx-xxx	Terminal block	COM1	RS-422	COM1	Wiring diagram 1 - COM1		
	DP10xxGBxx-xxx	Terminal block	COM1	RS-232C	COM2	Wiring diagram 2 - COM2		
			COM2			Wiring diagram 3 - COM2		
	DP10xxGCxx-xxx	Terminal block	COM1	RS-485	COM1	Wiring diagram 3 - COM1		
			COM2		RS-232C	COM2		Wiring diagram 3 - COM2
	DP10xxGDxx-xxx	Terminal block	COM1	RS-422	COM1	Wiring diagram 4 - COM1		
			COM2	RS-232C	COM2	Wiring diagram 3 - COM2		
	DP10xxGExx-xxx	Terminal block	COM1	RS-232C	COM2	Wiring diagram 2 - COM2		
			COM2		RS-485	COM1		Wiring diagram 5 - COM1
					COM3	Wiring diagram 3 - COM3		
	DP10xxGFxx-xxx	Terminal block	COM1	RS-485	COM1	Wiring diagram 3 - COM1		
COM3					Wiring diagram 2 - COM3			
COM2			RS-485	COM1	Wiring diagram 5 - COM1			
				COM3	Wiring diagram 3 - COM3			
DP10xxGGxx-xxx	Terminal block	COM1	RS-422	COM1	Wiring diagram 4 - COM1			
		COM2	RS-485	COM1	Wiring diagram 5 - COM1			
				COM3	Wiring diagram 3 - COM3			
DB1000B (MODBUS RTU)	DB1xxxBRxx-xxx	Terminal block		RS-232C	COM2	Wiring diagram 1 - COM2	DB1000B.Lst	
	DB1xxxBAxx-xxx			RS-422	COM1	Wiring diagram 1 - COM1		
	DB1xxxBSxx-xxx			RS-485	COM1	Wiring diagram 2 - COM1		
COM3		Wiring diagram 1 - COM3						
LT230 (MODBUS RTU)	LT23xxxS00-xx	Terminal block		RS-485	COM1	Wiring diagram 2 - COM1	LT230.Lst	
	LT23xxx200-xx				COM3	Wiring diagram 1 - COM3		
LT300 (MODBUS RTU)	LT35xxxRx0-xxx	Terminal block		RS-232C	COM2	Wiring diagram 1 - COM2	LT300.Lst	
	LT37xxxRx0-xxx				RS-422	COM1		Wiring diagram 1 - COM1
	LT35xxxAx0-xxx			RS-485		COM1		Wiring diagram 2 - COM1
	LT37xxxAx0-xxx				COM3	Wiring diagram 1 - COM3		
LT400 Series (MODBUS RTU)	LT45xxxRx-xxx	Terminal block		RS-232C	COM2	Wiring diagram 1 - COM2	LT400.Lst	
	LT47xxxRx-xxx				RS-422	COM1		Wiring diagram 1 - COM1
	LT45xxxSxx-xxx			RS-485		COM1		Wiring diagram 2 - COM1
	LT47xxxSxx-xxx				COM3	Wiring diagram 1 - COM3		
LT830 (MODBUS RTU)	LT830xx000-2xx	Terminal block		RS-485	COM1	Wiring diagram 2 - COM1	LT830.Lst	
					COM3	Wiring diagram 1 - COM3		

Graphic Recorder

PLC Selection on the Editor	Model	Port	Signal Level	TS Port	Connection	Lst File
KR2000 (MODBUS RTU)	KR21xxxRxA	Terminal block	RS-232C	COM2	Wiring diagram 1 - COM2	KR2000.Lst
			RS-485	COM1	Wiring diagram 2 - COM1	
				COM3	Wiring diagram 1 - COM3	
	KR21xxxQxA	Terminal block	RS-232C	COM2	Wiring diagram 1 - COM2	
			RS-485	COM1	Wiring diagram 2 - COM1	
				COM3	Wiring diagram 1 - COM3	

6.1.1 DP1000

Communication Setting

Editor

Communication setting

(Underlined setting: default)

Item	Setting	Remarks
Connection Mode	1 : 1 / <u>1:n</u> / Multi-link2 / Multi-link2 (Ethernet)	
Signal Level	<u>RS-232C</u> / RS-422/485	
Baud Rate	4800 / <u>9600</u> / 19200 / 38400 bps	
Data Length	<u>7</u> / 8 bits	
Stop Bit	<u>1</u> / 2 bits	
Parity	None / Odd / <u>Even</u>	
Target Port No.	<u>1</u> to 99	

Digital Program Controller

DP1000

The communication parameters can be set using keys attached to the digital program controller. Be sure to match the settings to those made on the [Communication Setting] tab window of the editor.

(Underlined setting: default)

Mode No.	Item	Setting	Remarks
Mode 1 (Operation status selection)	Program start method *	MASTER COM.: Start by communication	
	Pattern selection method *	COM: Selection by communication	
Mode 8 (Communication setting)	Communication function, type	COM: Host communication	
	Device No.	01 to 99	Invalid during RS-232C communication 00: Communication not possible
	Baud rate	4800 / 9600 bps	
	Communication characters (Data length, parity, stop bit)	Data length: <u>7</u> / 8 bits Parity: <u>Even</u> / Odd / None Stop bit: <u>1</u> / 2 bits	

* To start program operation from the TS series, select "MASTER COM." for program start method. To select a pattern number from the TS series, select "COM" for pattern selection method.

DP1000G

The communication parameters can be set using keys attached to the digital program controller. Be sure to match the settings to those made on the [Communication Setting] tab window of the editor.

(Underlined setting: default)

Mode No.	Item	Setting		Remarks
		COM1	COM2	
Mode 1 (Operation status selection)	Program start method *	COM: Start by communication		
	Pattern selection method *	COM: Selection by communication		
Mode 8 (Communication setting)	Communication type	Fixed according to communication specification	PORT2	
	Protocol	PRIVATE: CHINO's conventional protocol		When establishing a connection by using MODBUS RTU format, refer to "57. MODBUS".
	Communication function, type	COMM: Host communication		
	Device No.	01 to 99		Invalid during RS-232C communication 00: Communication not possible
	Baud rate	4800 / 9600 / <u>19200</u> / 38400 bps		
	Communication characters (Data length, parity, stop bit)	7N1: data length 7 bits, without parity, stop bit 1 7N2: data length 7 bits, without parity, stop bit 2 7E1: data length 7 bits, even parity, stop bit 1 7E2: data length 7 bits, even parity, stop bit 2 7O1: data length 7 bits, odd parity, stop bit 1 7O2: data length 7 bits, odd parity, stop bit 2 <u>8N1: data length 8 bits, without parity, stop bit 1</u> 8N2: data length 8 bits, without parity, stop bit 2 8E1: data length 8 bits, even parity, stop bit 1 8E2: data length 8 bits, even parity, stop bit 2 8O1: data length 8 bits, odd parity, stop bit 1 8O2: data length 8 bits, odd parity, stop bit 2		

* To start program operation from the TS series, select "COM" for program start method. To select a pattern number from the TS series, select "COM" for pattern selection method.

Notes on parameter change from the TS series

Before changing parameters from the TS series, function keys and the related mode in the setting menu must be locked using keys on the digital program controller. For more information, refer to the instruction manual for the controller issued by the manufacturer.

Available Memory

The available memory setting range varies depending on the device. Be sure to set within the range available with the device to be used. Use [TYPE] when assigning the indirect memory for macro programs.

Memory	TYPE	Remarks
D (data)	00H	Double-word
DN (individual data)	01H	Double-word
PG (program)	02H	Double-word

Address denotations

The assigned memory is indicated when editing the screen as shown below.

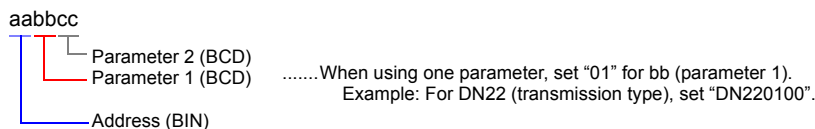

Note on memory setting

Do not access addresses that are not assigned in the memory map.

Memory D (Data)

Address Denotations			Name	Decimal Place	Command	
Address (BIN)	Parameter 1 (BCD)	Parameter 2 (BCD)			Read	Write
00	0	0	Pattern No.	-	△ 1, △ 1	-
01	0	0	Step No.	-	△ 1, △ 1	-
02	0	0	PV status	-	△ 1, △ 1	-
03	0	0	PV (measurement value)	4	△ 1, △ 1	-
04	0	0	SV (setting value)	4	△ 1, △ 1	-
05	0	0	Time display method	-	△ 1, △ 1	△ 2, △ 8
06	0	0	Time unit 1	-	△ 1, △ 1	-
07	0	0	Time	2	△ 1, △ 1	-
08	0	0	MV1 status	-	△ 1, △ 1	-
09	0	0	MV1	2	△ 1, △ 1	△ 2, △ 3
0a	0	0	MV2 status	-	△ 1, △ 1	-
0b	0	0	MV2	2	△ 1, △ 1	△ 2, △ 3
0e	0	0	Execution target SV	4	△ 1, △ 2	-
0f	0	0	Execution P	1	△ 1, △ 2	△ 2, △ 2
10	0	0	Execution I	-	△ 1, △ 2	△ 2, △ 2
11	0	0	Execution D	-	△ 1, △ 2	△ 2, △ 2
12	0	0	Execution AL1	4	△ 1, △ 2	△ 2, △ 2
13	0	0	Execution AL2	4	△ 1, △ 2	△ 2, △ 2
14	0	0	Execution AL3	4	△ 1, △ 2	△ 2, △ 2
15	0	0	Execution AL4	4	△ 1, △ 2	△ 2, △ 2
16	0	0	Execution OL	1	△ 1, △ 2	△ 2, △ 2
17	0	0	Execution OH	1	△ 1, △ 2	△ 2, △ 2
18	0	0	Execution change amount (OSL)	1	△ 1, △ 2	△ 2, △ 2
19	0	0	Execution sensor offset	4	△ 1, △ 2	△ 2, △ 2
1a	0	0	SV value offset	4	△ 1, △ 2	△ 2, △ 2
1b	0	0	2nd P	1	△ 1, △ 2	-
1c	0	0	2nd I	-	△ 1, △ 2	-
1d	0	0	2nd D	-	△ 1, △ 2	-
20	0	0	Controller / setting device	-	△ 1, △ 6	-
21	0	0	Setting device / thermoelectric type / resistance type	-	△ 1, △ 6	-
22	0	0	1st output	-	△ 1, △ 6	-
23	0	0	2nd output	-	△ 1, △ 6	-
24	0	0	Transmission	-	△ 1, △ 6	-
25	0	0	Time signal	-	△ 1, △ 6	-
26	0	0	External drive	-	△ 1, △ 6	-
27	0	0	Pattern select	-	△ 1, △ 6	-
28	0	0	Time unit 2	-	△ 1, △ 6	-
2b	0	0	FNC key (lock / non-lock)	-	△ 1, △ 7	△ 2, △ 7
2c	0	0	Mode 0 (lock / non-lock)	-	△ 1, △ 7	△ 2, △ 7
2d	0	0	Lock 1 (lock / non-lock)	-	△ 1, △ 7	△ 2, △ 7
2e	0	0	Lock 2 (lock / non-lock)	-	△ 1, △ 7	△ 2, △ 7
2f	0	0	Lock 3 (lock / non-lock)	-	△ 1, △ 7	△ 2, △ 7
30	0	0	Lock 4 (lock / non-lock)	-	△ 1, △ 7	△ 2, △ 7
31	0	0	Lock 5 (lock / non-lock)	-	△ 1, △ 7	△ 2, △ 7
32	0	0	Lock 6 (lock / non-lock)	-	△ 1, △ 7	△ 2, △ 7
33	0	0	Lock 7 (lock / non-lock)	-	△ 1, △ 7	△ 2, △ 7
34	0	0	Lock 8 (lock / non-lock)	-	△ 1, △ 7	△ 2, △ 7
35	0	0	Lock 9 (lock / non-lock)	-	△ 1, △ 7	△ 2, △ 7
38	0	0	AL1 (ON/OFF)	-	△ 1, △ 8	-
39	0	0	AL2 (ON/OFF)	-	△ 1, △ 8	-
3a	0	0	AL3 (ON/OFF)	-	△ 1, △ 8	-
3b	0	0	AL4 (ON/OFF)	-	△ 1, △ 8	-
3c	0	0	Wait time alert	-	△ 1, △ 8	-
3d	0	0	Error	-	△ 1, △ 8	-

Address Denotations			Name	Decimal Place	Command	
Address (BIN)	Parameter 1 (BCD)	Parameter 2 (BCD)			Read	Write
3e	0	0	TS1 (ON/OFF)	-	△ 1, △ 8	-
3f	0	0	TS2 (ON/OFF)	-	△ 1, △ 8	-
40	0	0	TS3 (ON/OFF)	-	△ 1, △ 8	-
41	0	0	TS4 (ON/OFF)	-	△ 1, △ 8	-
42	0	0	TS5 (ON/OFF)	-	△ 1, △ 8	-
43	0	0	TS6 (ON/OFF)	-	△ 1, △ 8	-
44	0	0	TS7 (ON/OFF)	-	△ 1, △ 8	-
45	0	0	TS8 (ON/OFF)	-	△ 1, △ 8	-
46	0	0	TS9 (ON/OFF)	-	△ 1, △ 8	-
47	0	0	TS10 (ON/OFF)	-	△ 1, △ 8	-
4a	Pattern No.	0	RUN	-	△ 1, △ 9	△ 2, △ 1
4b	0	0	STOP	-	△ 1, △ 9	△ 2, △ 1
4c	0	0	RESET	-	△ 1, △ 9	△ 2, △ 1
4d	0	0	END	-	△ 1, △ 9	-
4e	0	0	ADV	-	△ 1, △ 9	△ 2, △ 1
4f	0	0	CONST	-	△ 1, △ 9	△ 2, △ 4
50	0	0	MAN1	-	△ 1, △ 9	△ 2, △ 3
51	0	0	MAN2	-	△ 1, △ 9	△ 2, △ 3
52	0	0	WAIT	-	△ 1, △ 9	-
53	0	0	AT	-	△ 1, △ 9	△ 2, △ 6
54	0	0	FNC key LOCK	-	△ 1, △ 9	-
55	0	0	M/S	-	△ 1, △ 9	-
56	0	0	FAST	-	△ 1, △ 9	-
57	0	0	SV Up	-	△ 1, △ 9	-
58	0	0	SV Down	-	△ 1, △ 9	-
5b	0	0	Constant SV	4	△ 1, △ 1	△ 2, △ 4

Memory DN (Individual Data)

Address Denotations			Name	Decimal Place	Command	
Address (BIN)	Parameter 1 (BCD)	Parameter 2 (BCD)			Read	Write
00	Alarm No. (1 to 8)	0	AL1	4	△ 1, △ 4	△ 12
01	Alarm No. (1 to 8)	0	AL2	4	△ 1, △ 4	△ 12
02	Alarm No. (1 to 8)	0	AL3	4	△ 1, △ 4	△ 12
03	Alarm No. (1 to 8)	0	AL4	4	△ 1, △ 4	△ 12
06	PID No. (1 to 8, 91 to 98)	0	P	1	△ 1, △ 4	△ 13
07	PID No. (1 to 8, 91 to 98)	0	I	-	△ 1, △ 4	△ 13
08	PID No. (1 to 8, 91 to 98)	0	D	-	△ 1, △ 4	△ 13
0b	Parameter No. (1 to 8)	0	Output change amount limit	1	△ 1, △ 4	△ 14
0e	Parameter No. (1 to 8)	0	Output lower limit	1	△ 1, △ 4	△ 15
0f	Parameter No. (1 to 8)	0	Output upper limit	1	△ 1, △ 4	△ 15
12	Parameter No. (1 to 8)	0	Sensor offset	4	△ 1, △ 4	△ 16
15	Parameter No. (1 to 8)	0	Actual temperature compensation	4	△ 1, △ 4	△ 17
18	Parameter No. (1 to 8)	0	Wait time alert	2	△ 1, △ 4	△ 18
1b	Parameter No. (1 to 8)	0	Time signal ON time	2	△ 1, △ 4	△ 19
1c	Parameter No. (1 to 8)	0	Time signal OFF time	2	△ 1, △ 4	△ 19
1f	1	0	Digital filter	1	△ 1, △ 4	△ 20
22	1	0	Transmission type	-	△ 1, △ 4	△ 21

Address Denotations			Name	Decimal Place	Command	
Address (BIN)	Parameter 1 (BCD)	Parameter 2 (BCD)			Read	Write
23	1	0	Scale (min.)	4	△ 1, △ 4	△ 21
24	1	0	Scale (max.)	4	△ 1, △ 4	△ 21
27	1	0	2nd output gap	1	△ 1, △ 4	△ 22
2a	1	0	2nd output P	1	△ 1, △ 4	△ 23
2b	1	0	2nd output I	-	△ 1, △ 4	△ 23
2c	1	0	2nd output D	-	△ 1, △ 4	△ 23
2f	1	0	2nd output change amount limit	1	△ 1, △ 4	△ 24
32	1	0	2nd OL	1	△ 1, △ 4	△ 25
33	1	0	2nd OH	1	△ 1, △ 4	△ 25
36	1	0	2nd deadband	1	△ 1, △ 4	△ 26
39	1	0	2nd PV output error	1	△ 1, △ 4	△ 27
3c	1	0	2nd output normal/reverse	-	△ 1, △ 4	△ 28
3f	1	0	2nd pulse cycle	-	△ 1, △ 4	△ 29
42	1	0	Measurement input unit (input type No.)	-	△ 1, △ 4	△ 30
43	1	0	Measurement input unit (unit)	-	△ 1, △ 4	△ 30
46	1	0	CJ INT/EXT	-	△ 1, △ 4	△ 31
49	1	0	SV decimal place	-	△ 1, △ 4	△ 32
4c	1	0	PV decimal place	-	△ 1, △ 4	△ 33
4f	1	0	Alarm filter	-	△ 1, △ 4	△ 34
52	Alarm No. (1 to 4)	0	Alarm mode	-	△ 1, △ 4	△ 35
53	1	0	Alarm deadband	4	△ 1, △ 4	△ 35
56	1	0	Deadband	1	△ 1, △ 4	△ 36
59	1	0	Pulse cycle	-	△ 1, △ 4	△ 37
5c	1	0	Zero	1	△ 1, △ 4	△ 38
5d	1	0	Span	1	△ 1, △ 4	△ 38
5e	1	0	Deadband	1	△ 1, △ 4	△ 38
61	1	0	Output preset	1	△ 1, △ 4	△ 39
64	1	0	Output in PV error	1	△ 1, △ 4	△ 40
67	1	0	Output normal/reverse	-	△ 1, △ 4	△ 41
6a	1	0	Linear range (zero)	4	△ 1, △ 4	△ 42
6b	1	0	Linear range (span)	4	△ 1, △ 4	△ 42
6e	1	0	Linear scale (min.)	4	△ 1, △ 4	△ 43
6f	1	0	Linear scale (max.)	4	△ 1, △ 4	△ 43
72	1	0	ARW (lower limit)	1	△ 1, △ 4	△ 44
73	1	0	ARW (upper limit)	1	△ 1, △ 4	△ 44
76	Parameter No. (1 to 8)	0	AT2SV (ON/OFF)	-	△ 1, △ 4	△ 45
77	Parameter No. (1 to 8)	0	AT2SV	4	△ 1, △ 4	△ 45
7a	Parameter No. (1 to 7)	0	Break SV	4	△ 1, △ 4	△ 46
7d	Parameter No. (1 to 8)	0	AT3SV (ON/OFF)	-	△ 1, △ 4	△ 47
7e	Parameter No. (1 to 8)	0	AT3SV	4	△ 1, △ 4	△ 47
81	1	0	AT start direction	-	△ 1, △ 4	△ 48
84	1	0	SV at reset	4	△ 1, △ 4	△ 49
87	1	0	SV display scale (min.)	4	△ 1, △ 4	△ 50
88	1	0	SV display scale (max.)	4	△ 1, △ 4	△ 50
8b	1	0	Thermocouple type (thermocouple No.)	-	△ 1, △ 4	△ 51
8c	1	0	Thermocouple type (unit)	-	△ 1, △ 4	△ 51
8f	1	0	SV scale (min.)	4	△ 1, △ 4	△ 52
90	1	0	SV scale (max.)	4	△ 1, △ 4	△ 52

Memory PG (Program)

Address Denotations			Name	Decimal Place	Command	
Address (BIN)	Parameter 1 (BCD)	Parameter 2 (BCD)			Read	Write
00	Pattern No.	0	Start SV	4	△ 1, △ 3	△ 3, △ 1
01	Pattern No.	0	SV/PV start	-	△ 1, △ 3	△ 3, △ 1
04	Pattern No.	Step No.	Program setting SV	4	△ 1, △ 3	△ 3, △ 2
05	Pattern No.	Step No.	Program setting time	2	△ 1, △ 3	△ 3, △ 2
06	Pattern No.	Step No.	Step repeat times	-	△ 1, △ 3	-
07	Pattern No.	Step No.	PID No.	-	△ 1, △ 3	△ 3, △ 4
08	Pattern No.	Step No.	ALM No.	-	△ 1, △ 3	△ 3, △ 4
09	Pattern No.	Step No.	OPL No.	-	△ 1, △ 3	△ 3, △ 4
0a	Pattern No.	Step No.	OSL No.	-	△ 1, △ 3	△ 3, △ 4
0b	Pattern No.	Step No.	Sensor offset No.	-	△ 1, △ 3	△ 3, △ 4
0c	Pattern No.	Step No.	Actual temperature compensation No.	-	△ 1, △ 3	△ 3, △ 4
0d	Pattern No.	Step No.	Wait time No.	-	△ 1, △ 3	△ 3, △ 4
0e	Pattern No.	Step No.	TS1	-	△ 1, △ 3	△ 3, △ 4
0f	Pattern No.	Step No.	TS2	-	△ 1, △ 3	△ 3, △ 4
10	Pattern No.	Step No.	TS3	-	△ 1, △ 3	△ 3, △ 4
11	Pattern No.	Step No.	TS4	-	△ 1, △ 3	△ 3, △ 4
12	Pattern No.	Step No.	TS5	-	△ 1, △ 3	△ 3, △ 4
13	Pattern No.	Step No.	TS6	-	△ 1, △ 3	△ 3, △ 4
14	Pattern No.	Step No.	TS7	-	△ 1, △ 3	△ 3, △ 4
15	Pattern No.	Step No.	TS8	-	△ 1, △ 3	△ 3, △ 4
16	Pattern No.	Step No.	TS9	-	△ 1, △ 3	△ 3, △ 4
17	Pattern No.	Step No.	TS10	-	△ 1, △ 3	△ 3, △ 4
1a	Pattern No.	Step No.	Link target pattern No.	-	△ 1, △ 3	△ 3, △ 3
1b	Pattern No.	Step No.	Output at 1st end	-	△ 1, △ 3	△ 3, △ 3
1c	Pattern No.	Step No.	Output at 2nd end	-	△ 1, △ 3	△ 3, △ 3
1f	0	0	Pattern repeat times	-	△ 1, △ 3	△ 3, △ 6
22	Pattern No.	0	Set number of steps	-	△ 1, △ 5	-
23	Pattern No.	0	Remaining number of steps	-	△ 1, △ 5	-

PLC_CTL

Macro command "PLC_CTL F0 F1 F2"

Contents	F0	F1 (= \$u n)		F2
Alarm reset	1 - 8 (PLC1 - 8)	n	Station number	2
		n + 1	Command: 0000H	
Pattern select	1 - 8 (PLC1 - 8)	n	Station number	3
		n + 1	Command: 0001H	
		n + 2	Pattern No.	
Step repeat	1 - 8 (PLC1 - 8)	n	Station number	6
		n + 1	Command: 0002H	
		n + 2	Pattern No.	
		n + 3	Start step	
		n + 4	End step	
		n + 5	Repeat times Reset: 0000H Times: 0001H to 0099H	
Pattern copy	1 - 8 (PLC1 - 8)	n	Station number	4
		n + 1	Command: 0003H	
		n + 2	Copy source pattern No.	
		n + 3	Copy target pattern No.	
Pattern clear	1 - 8 (PLC1 - 8)	n	Station number	3
		n + 1	Command: 0004H	
		n + 2	Pattern No. Clear all patterns: 0000H Clear individual pattern: 0001H to 0030H	

6.1.2 DB1000B (MODBUS RTU)

Communication Setting

Editor

Communication setting

(Underlined setting: default)

Item	Setting	Remarks
Connection Mode	1 : 1 / <u>1:n</u> / Multi-link2 / Multi-link2 (Ethernet)	
Signal Level	RS-232C / <u>RS-422/485</u>	
Baud Rate	4800 / <u>9600</u> / 19200 / 38400 bps	
Data Length	<u>8 bits</u>	
Stop Bit	<u>1</u> / 2 bits	
Parity	<u>None</u> / Odd / Even	
Target Port No.	<u>1</u> to 99	

Digital Indicating Controller

The communication parameters can be set using keys attached to the digital indicating controller. Be sure to match the settings to those made on the [Communication Setting] tab window of the editor.

(Underlined setting: default)

Mode No.	Item	Setting	Remarks
Mode 7 (Communication setting)	Baud rate	4800 / <u>9600</u> / 19200 / 38400 bps	
	Device No.	<u>01</u> to 99	
	Communication function	<u>COM: Host communication</u>	
	Communication protocol	<u>MODBUS (RTU)</u>	
	Communication characters (Data length, parity, stop bit)	<u>8 bits / without parity / 1 bit</u> 8 bits / without parity / 2 bits 8 bits / even parity / 1 bit 8 bits / even parity / 2 bits 8 bits / odd parity / 1 bit 8 bits / odd parity / 2 bits	

Notes on parameter change from the TS series

Before changing parameters from the TS series, all modes on the setting screen must be locked using keys on the digital indicating controller. For more information, refer to the instruction manual for the controller issued by the manufacturer.

Available Memory

The available memory setting range varies depending on the device. Be sure to set within the range available with the device to be used. Use [TYPE] when assigning the indirect memory for macro programs.

Memory	TYPE	Remarks
4 (analog setting value)	00H	
3 (analog input data)	01H	Read only
0 (digital setting value)	02H	
1 (digital input data)	03H	Read only

Indirect Memory Designation

Specify the value obtained by subtracting "1" from the real memory address for the memory address number.

6.1.3 LT230 (MODBUS RTU)

Communication Setting

Editor

Communication setting

(Underlined setting: default)

Item	Setting	Remarks
Connection Mode	1 : 1 / <u>1:n</u> / Multi-link2 / Multi-link2 (Ethernet)	
Signal Level	<u>RS-422/485</u>	
Baud Rate	<u>9600</u> / 19200 bps	
Data Length	<u>8 bits</u>	
Stop Bit	<u>1</u> / 2 bits	
Parity	<u>None</u> / Odd / Even	
Target Port No.	<u>1</u> to 99	

Digital Indicating Controller

The communication parameters can be set using keys attached to the digital indicating controller. Be sure to match the settings to those made on the [Communication Setting] tab window of the editor.

(Underlined setting: default)

Mode	Indication	Item	Setting
Mode 1 eng (engineering)	LoCK	Key lock	4: All items prohibited *
Mode 7 com (communication setting)	PtCL	Communication protocol	<u>rtU: MODBUS (RTU)</u>
	FUnC	Communication function	<u>Com: Host communication</u>
	AdrS	Device No.	<u>1</u> to 99
	rAtE	Baud rate	<u>9600</u> / 19200 bps
	CHAR	Character (Data length, parity, stop bit)	<u>5: 8 bits / without parity / 1 bit</u> 6: 8 bits / without parity / 2 bits 7: 8 bits / even parity / 1 bit 8: 8 bits / even parity / 2 bits 9: 8 bits / odd parity / 1 bit 10: 8 bits / odd parity / 2 bits

* When changing parameters from the TS series, set "LoCK (key lock): 4".

Available Memory

The available memory setting range varies depending on the device. Be sure to set within the range available with the device to be used. Use [TYPE] when assigning the indirect memory for macro programs.

Memory	TYPE	Remarks
4 (analog setting value)	00H	
3 (analog input data)	01H	Read only
0 (digital setting value)	02H	
1 (digital input data)	03H	Read only

Indirect Memory Designation

Specify the value obtained by subtracting "1" from the real memory address for the memory address number.

6.1.4 LT300 (MODBUS RTU)

Communication Setting

Editor

Communication setting

(Underlined setting: default)

Item	Setting	Remarks
Connection Mode	1 : 1 / <u>1:n</u> / Multi-link2 / Multi-link2 (Ethernet)	
Signal Level	RS-232C / <u>RS-422/485</u>	
Baud Rate	<u>9600</u> / 19200 bps	
Data Length	<u>8 bits</u>	
Stop Bit	<u>1</u> / 2 bits	
Parity	<u>None</u> / Odd / Even	
Target Port No.	<u>1</u> to 99	

Digital Indicating Controller

The communication parameters can be set using keys attached to the digital indicating controller.

Be sure to match the settings to those made on the [Communication Setting] tab window of the editor.

(Underlined setting: default)

Mode	Indication	Item	Setting
Mode 1 eng (engineering)	LoCK	Key lock	4: All items prohibited *
Mode 7 com (communication setting)	PTCL	Communication protocol	<u>rtU: MODBUS (RTU)</u>
	FUnC	Communication function	<u>Com: Host communication</u>
	AdrS	Device No.	<u>01</u> to 99
	rAtE	Baud rate	<u>9600</u> / 19200 bps
	CHAR	Character (Data length, parity, stop bit)	<u>5: 8 bits / without parity / 1 bit</u> 6: 8 bits / without parity / 2 bits 7: 8 bits / even parity / 1 bit 8: 8 bits / even parity / 2 bits 9: 8 bits / odd parity / 1 bit 10: 8 bits / odd parity / 2 bits

* When changing parameters from the TS series, set "LoCK (key lock): 4".

Available Memory

The available memory setting range varies depending on the device. Be sure to set within the range available with the device to be used. Use [TYPE] when assigning the indirect memory for macro programs.

Memory	TYPE	Remarks
4 (analog setting value)	00H	
3 (analog input data)	01H	Read only
0 (digital setting value)	02H	
1 (digital input data)	03H	Read only

Indirect Memory Designation

Specify the value obtained by subtracting "1" from the real memory address for the memory address number.

6.1.5 LT400 Series (MODBUS RTU)

Communication Setting

Editor

Communication setting

(Underlined setting: default)

Item	Setting	Remarks
Connection Mode	1 : 1/1 : n / Multi-link2 / Multi-link2 (Ethernet) / 1 : n Multi-link2 (Ethernet)	
Signal Level	RS-232C / <u>RS-422/485</u>	
Baud Rate	<u>9600</u> / 19200 bps	
Data Length	<u>8 bits</u>	
Stop Bit	<u>1</u> / 2 bits	
Parity	<u>None</u> / Odd / Even	
Target Port No.	<u>1</u> to 99	

Digital Indicating Controller

The communication parameters can be set using keys attached to the digital indicating controller. Be sure to match the settings to those made on the [Communication Setting] tab window of the editor.

(Underlined setting: default)

Mode	Display	Item	Setting
Mode 1 eng (engineering)	LoCK	Key lock	4: All items prohibited *
Mode 7 commu (communication setting)	PrtCL	Communication protocol	<u>rtU: MODBUS (RTU)</u>
	FUnC	Communication function	<u>Com: Host communication</u>
	AdrS	Device No.	<u>01</u> to 99
	rAtE	Baud rate	<u>9600</u> / 19200 bps
	CHARA	Character (Data length, parity, stop bit)	<u>8N1: 8 bits / without parity / 1 bit</u> 8N2: 8 bits / without parity / 2 bits 8E1: 8 bits / even parity / 1 bit 8E2: 8 bits / even parity / 2 bits 8O1: 8 bits / odd parity / 1 bit 8O2: 8 bits / odd parity / 2 bits

* When changing parameters from the TS series, set "LoCK (key lock): 4".

Available Memory

The available memory setting range varies depending on the device. Be sure to set within the range available with the device to be used. Use [TYPE] when assigning the indirect memory for macro programs.

Memory	TYPE	Remarks
4 (analog setting value)	00H	
3 (analog input data)	01H	Read only
0 (digital setting value)	02H	
1 (digital input data)	03H	Read only

Indirect Memory Designation

Specify the value obtained by subtracting "1" from the actual memory address for the memory address number.

6.1.6 LT830 (MODBUS RTU)

Communication Setting

Editor

Communication setting

(Underlined setting: default)

Item	Setting	Remarks
Connection Mode	1 : 1 / <u>1:n</u> / Multi-link2 / Multi-link2 (Ethernet)	
Signal Level	<u>RS-422/485</u>	
Baud Rate	<u>9600</u> / 19200 bps	
Data Length	<u>8 bits</u>	
Stop Bit	<u>1</u> / 2 bits	
Parity	<u>None</u> / Odd / Even	
Target Port No.	<u>1</u> to 99	

Digital Indicating Controller

The communication parameters can be set using keys attached to the digital indicating controller.

Be sure to match the settings to those made on the [Communication Setting] tab window of the editor.

(Underlined setting: default)

Mode	Indication	Item	Setting	Remarks
Mode 5	LoCK	Lock function	3: All items prohibited *	
tyPE (type)	PtCL	Communication protocol	<u>rtU: MODBUS (RTU)</u>	
	FUnC	Communication function	<u>Com: Host communication</u>	
Mode 6	AdrS	Device No.	<u>1</u> to 99	
com (communication setting)	rAtE	Baud rate	<u>9600</u> / 19200 bps	
	CHAr	Character (Data length, parity, stop bit)	<u>8n1: 8 bits / without parity / 1 bit</u> 8n2: 8 bits / without parity / 2 bits 8E1: 8 bits / even parity / 1 bit 8E2: 8 bits / even parity / 2 bits 8o1: 8 bits / odd parity / 1 bit 8o2: 8 bits / odd parity / 2 bits	

* When changing parameters from the TS series, set "LoCK (lock function): 3".

Available Memory

The available memory setting range varies depending on the device. Be sure to set within the range available with the device to be used. Use [TYPE] when assigning the indirect memory for macro programs.

Memory	TYPE	Remarks
4 (analog setting value)	00H	
3 (analog input data)	01H	Read only
0 (digital setting value)	02H	
1 (digital input data)	03H	Read only

Indirect Memory Designation

Specify the value obtained by subtracting "1" from the real memory address for the memory address number.

6.1.7 KR2000 (MODBUS RTU)

Communication Setting

Editor

Communication setting

(Underlined setting: default)

Item	Setting	Remarks
Connection Mode	1: 1 / <u>1:n</u> / Multi-link2 / Multi-link2 (Ethernet)	
Signal Level	RS-232C / <u>RS-422/485</u>	
Baud Rate	<u>9600</u> / 19200 bps	
Data Length	<u>8</u> bits	
Stop Bit	<u>1</u> / 2 bits	
Parity	<u>None</u> / Odd / Even	
Target Port No.	<u>1</u> to 31	

Graphic Recorder

Selector switch

When establishing a communication with a graphic recorder, set the selector switch at the top of the unit.

(Underlined setting: default)

Selector switch	Setting	Remarks
	232C: RS-232C connection <u>485: RS-485 connection</u>	Switch the signal with the power to the recorder OFF.

Communication setting

The communication parameters can be set using MENU keys attached to the graphic recorder.

Be sure to match the settings to those made on the [Communication Setting] tab window of the editor.

(Underlined setting: default)

Setting Menu	Menu	Item	Setting	Remarks
System setting	Host communication	Communication mode	<u>RTU: MODBUS (RTU)</u>	
		Device address	<u>01</u> to 31	
		Bit rate	<u>9600</u> / 19200 bps	
		Communication characters (Data length, parity, stop bit)	<u>8N1: 8 bits / without parity / 1 bit</u> 8N2: 8 bits / without parity / 2 bits 8E1: 8 bits / even parity / 1 bit 8E2: 8 bits / even parity / 2 bits 8O1: 8 bits / odd parity / 1 bit 8O2: 8 bits / odd parity / 2 bits	

Available Memory

The available memory setting range varies depending on the device. Be sure to set within the range available with the device to be used. Use [TYPE] when assigning the indirect memory for macro programs.

Memory	TYPE	Remarks
4 (analog setting value)	00H	
3 (analog input data)	01H	Read only
0 (digital setting value)	02H	
1 (digital input data)	03H	Read only

Indirect Memory Designation

Specify the value obtained by subtracting "1" from the real memory address for the memory address number.

6.1.8 Wiring Diagrams

When Connected at COM1:

RS-422/RS-485

Wiring diagram 1 - COM1

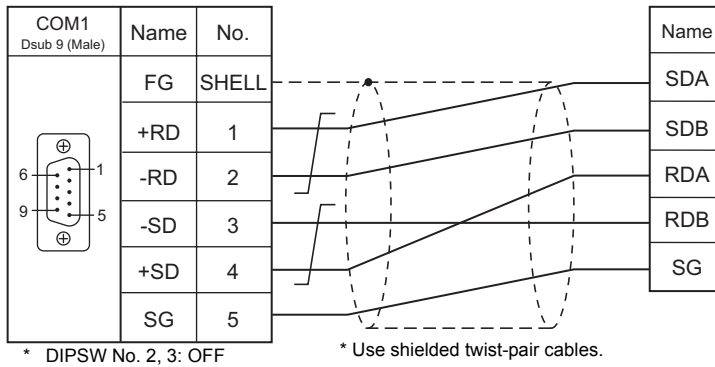

Wiring diagram 2 - COM1

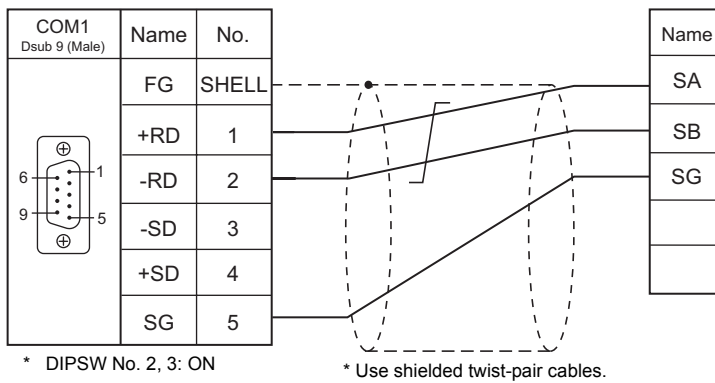

Wiring diagram 3 - COM1

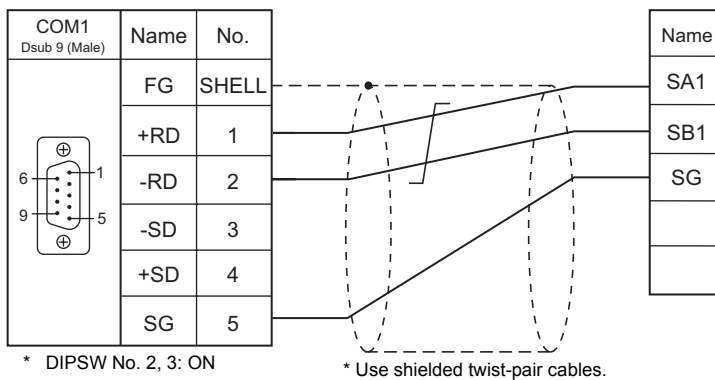

Wiring diagram 4 - COM1

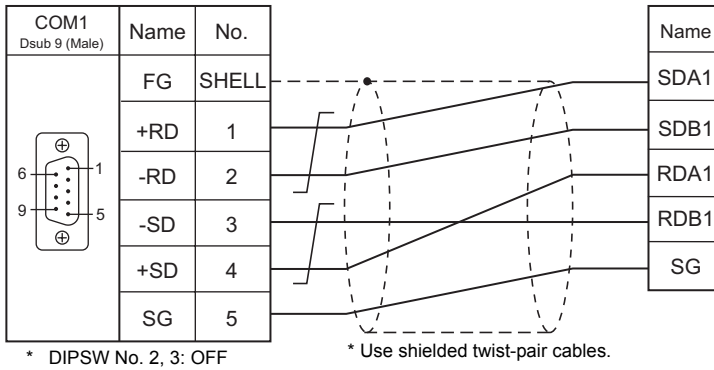

Wiring diagram 5 - COM1

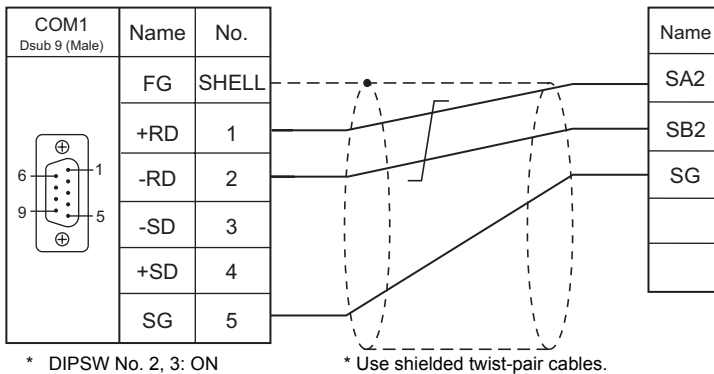

When Connected at COM2:

RS-232C

Wiring diagram 1 - COM2

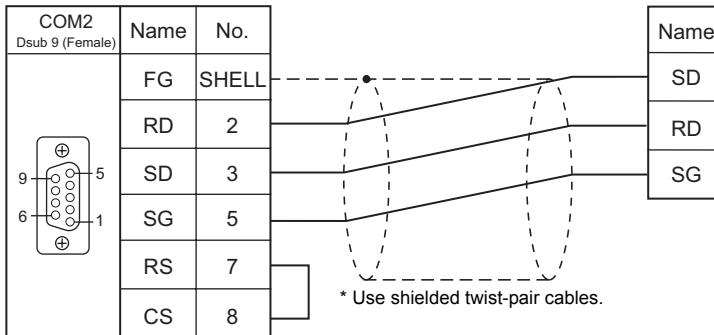

Wiring diagram 2 - COM2

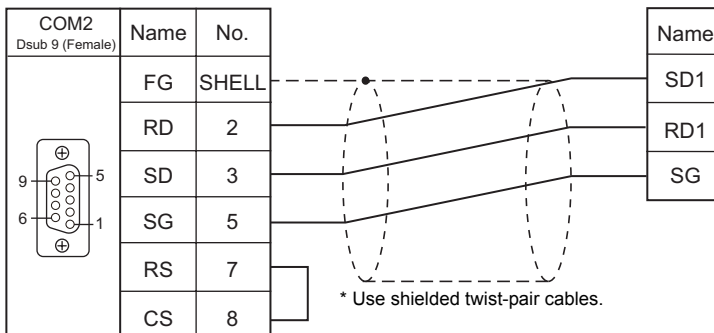

Wiring diagram 3 - COM2

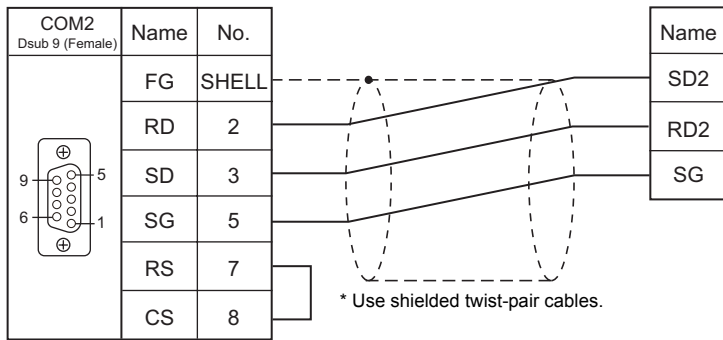

When Connected at COM3:

RS-485

Wiring diagram 1 - COM3

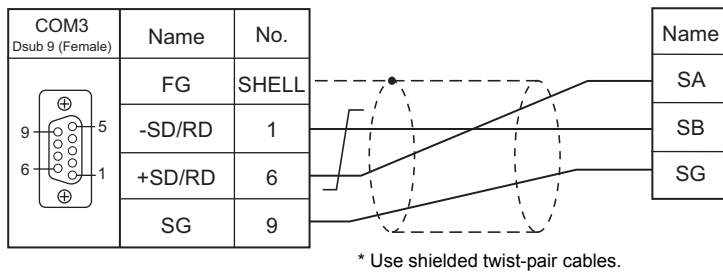

Wiring diagram 2 - COM3

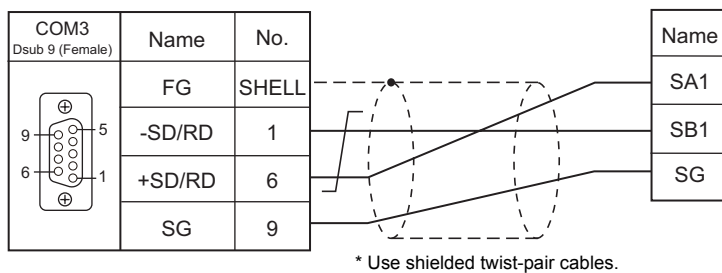

Wiring diagram 3 - COM3

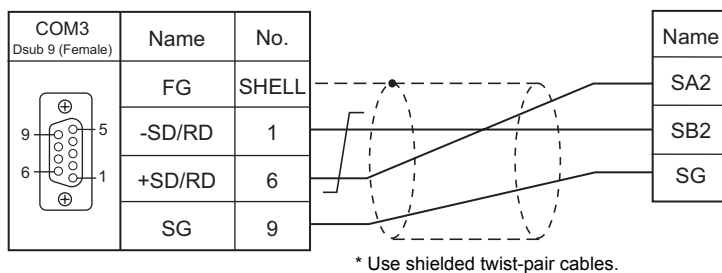

MEMO

Please use this page freely.

7. CIMON

7.1 PLC Connection

7.1 PLC Connection

Serial Connection

PLC Selection on the Editor	CPU	Unit/Port		Signal Level	TS Port	Connection	Ladder Transfer ^{*1}
BP series	CM2-BPxxMDxx-R CM2-BPxxMDxx-T CM2-BPxxMDxx-S CM2-BPxxMDxx-U	LOADER port		RS-232C	COM2	Wiring diagram 1 - COM2	×
	CM2-BPxxMDxx-R	Comm port		RS-232C	COM2	Wiring diagram 3 - COM2	
	CM2-BPxxMDxx-T	CH1		RS-232C	COM2	Wiring diagram 2 - COM2	
		CH2		RS-422	COM1	Wiring diagram 3 - COM1	
				RS-485	COM3	Wiring diagram 1 - COM3	
	CM2-BPxxMDxx-S	Comm port		RS-422	COM1	Wiring diagram 1 - COM1	
				RS-485	COM3	Wiring diagram 2 - COM3	
	CM2-BPxxMDxx-U	CH1		RS-422	COM1	Wiring diagram 2 - COM1	
		CH2		RS-422	COM1	Wiring diagram 3 - COM1	
				RS-485	COM3	Wiring diagram 1 - COM3	
CP series	CM1-CPxx	LOADER port		RS-232C	COM2	Wiring diagram 1 - COM2	×
	CM1-CP4C	Comm port		RS-232C	COM2	Wiring diagram 4 - COM2	
	CM1-CP4D	Comm port		RS-422	COM1	Wiring diagram 4 - COM1	
				RS-485	COM3	Wiring diagram 3 - COM3	
	CM1-CPxx	CM1-SC01A	CH1	RS-232C	COM2	Wiring diagram 2 - COM2	
			CH1	RS-422	COM1	Wiring diagram 5 - COM1	
		CM1-SC01B		CH2	RS-422	COM1	
				RS-485	COM3	Wiring diagram 4 - COM3	
		CM1-SC02A	CH1	RS-232C	COM2	Wiring diagram 2 - COM2	
			CH2	RS-422	COM1	Wiring diagram 5 - COM1	
	RS-485	COM3		Wiring diagram 4 - COM3			

*1 For the ladder transfer function, see "Appendix 5 Ladder Transfer Function".

7.1.1 BP Series

Communication Setting

Editor

Communication setting

(Underlined setting: default)

Item	Setting	Remarks
Connection Mode	<u>1</u> :1 / Multi-link2 / Multi-link2 (Ethernet)	
Signal Level	<u>RS-232C</u> / RS-422/485	
Baud Rate	9600 / 19200 / <u>38400</u> bps	
Data Length	7 / <u>8</u> bits	
Stop Bit	<u>1</u> / 2 bits	
Parity	<u>None</u> / Odd / Even	

PLC

CM2-BPxxMDxx-R, T, S, U (LOADER Port)

No particular setting is necessary on the PLC.

The communication parameters are fixed; signal level: RS-232C, baud rate: 38400 bps, data length: 8 bits, stop bit: 1 bit, parity: none.

CM2-BPxxMDxx-T, U (CH1)

Make communication settings using the application software "CICON". For more information, refer to the instruction manual issued by CIMON.

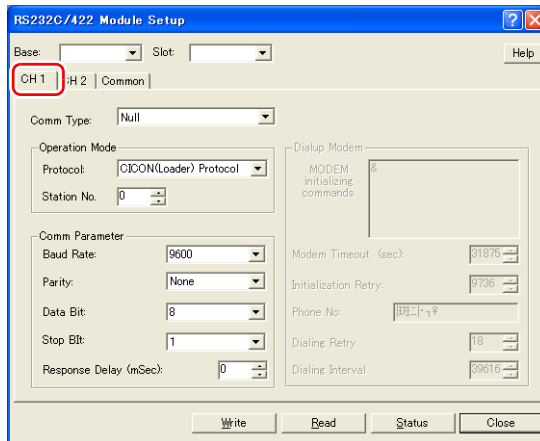

Item	Setting	Remarks
Protocol	CICON(Loader) Protocol	
Baud Rate	9600 / 19200 / 38400 bps	
Parity	Even / Odd / None	
Data Bit	7 / 8 bits	
Stop Bit	1 / 2 bits	

CM2-BPxxMDxx-T, U (CH2)

Make communication settings using the application software "CICON". For more information, refer to the instruction manual issued by CIMON.

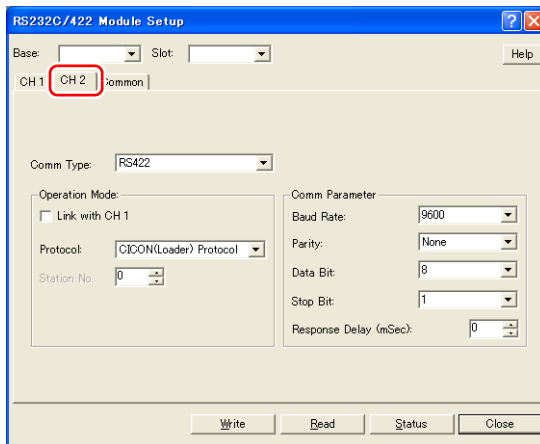

Item	Setting	Remarks
Comm Type	RS422 / RS485	RS-422: 4-wire RS-485: 2-wire
Protocol	CICON(Loader) Protocol	
Baud Rate	9600 / 19200 / 38400 bps	
Parity	Even / Odd / None	
Data Bit	7 / 8 bits	
Stop Bit	1 / 2 bits	

CM2-BPxxMDxx-R, S

Make communication settings using the application software "CICON". For more information, refer to the instruction manual issued by CIMON.

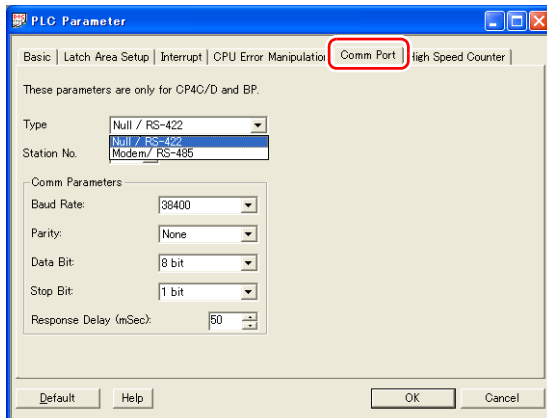

Item	Setting	Remarks
Type	Null / RS-422, Modem / RS-485	RS-232C connection: Null / RS-422 RS-422 (4-wire) connection: Null / RS-422 RS-485 (2-wire) connection: Modem / RS-485
Baud Rate	9600 / 19200 / 38400 bps	
Parity	Even / Odd / None	
Data Bit	7 / 8 bits	
Stop Bit	1 / 2 bits	

Available Memory

The available memory setting range varies depending on the PLC model. Be sure to set within the range available for the PLC. Use [TYPE] when assigning the indirect memory for macro programs.

Memory	TYPE	Remarks
D (Data Memory)	00H	
X (External Input)	01H	
Y (External Output)	02H	
M (Internal Relay)	03H	
L (Internal Relay)	04H	
K (Latch Relay)	05H	
F (Flags)	06H	Read only
T (Timer Output)	07H	
TS (Timer SV)	08H	
TC (Timer PV)	09H	
C (Counter Output)	0AH	
CS (Counter SV)	0BH	
CC (Counter PV)	0CH	
S (Step Control Relay)	0DH	*1

*1 The addresses are expressed in "bytes". For word designation, specify an even-numbered address.

7.1.2 CP Series

Communication Setting

Editor

Communication setting

(Underlined setting: default)

Item	Setting	Remarks
Connection Mode	<u>1:1</u> / Multi-link2 / Multi-link2 (Ethernet)	
Signal Level	<u>RS-232C</u> / RS-422/485	
Baud Rate	9600 / 19200 / <u>38400</u> bps	
Data Length	7 / <u>8</u> bits	
Stop Bit	<u>1</u> / 2 bits	
Parity	<u>None</u> / Odd / Even	

PLC

LOADER Port

No particular setting is necessary on the PLC.

The communication parameters are fixed; signal level: RS-232C, baud rate: 38400 bps, data length: 8 bits, stop bit: 1 bit, parity: none.

CM1-CP4C/CM1-CP4D

Make communication settings using the application software "CICON". For more information, refer to the instruction manual issued by CIMON.

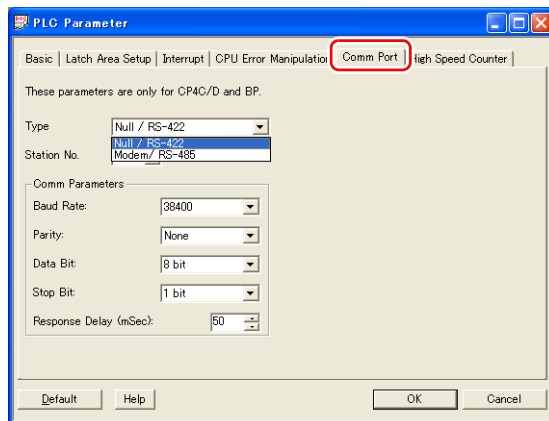

Item	Setting	Remarks
Type	Null / RS-422, Modem / RS-485	RS-232C connection: Null / RS-422 RS-422 (4-wire) connection: Null / RS-422 RS-485 (2-wire) connection: Modem / RS-485
Baud Rate	9600 / 19200 / 38400 bps	
Parity	Even / Odd / None	
Data Bit	7 / 8 bits	
Stop Bit	1 / 2 bits	

CM1-SC01A, CM1-SC01B, CM1-SC02A (CH1)

Make communication settings using the application software "CIMON". For more information, refer to the instruction manual issued by CIMON.

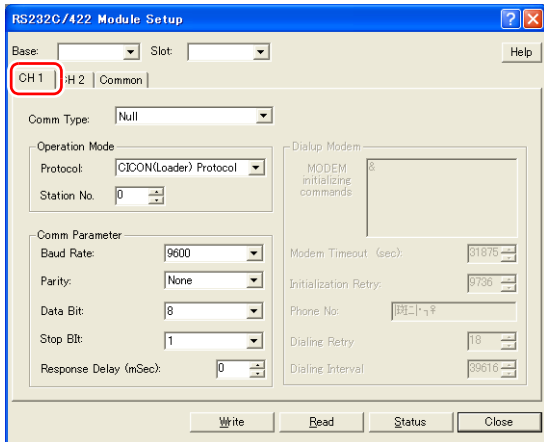

Item	Setting	Remarks
Protocol	CICON(Loader) Protocol	
Baud Rate	9600 / 19200 / 38400 bps	
Parity	Even / Odd / None	
Data Bit	7 / 8 bits	
Stop Bit	1 / 2 bits	

CM1-SC01B, CM1-SC02A (CH2)

Make communication settings using the application software "CIMON". For more information, refer to the instruction manual issued by CIMON.

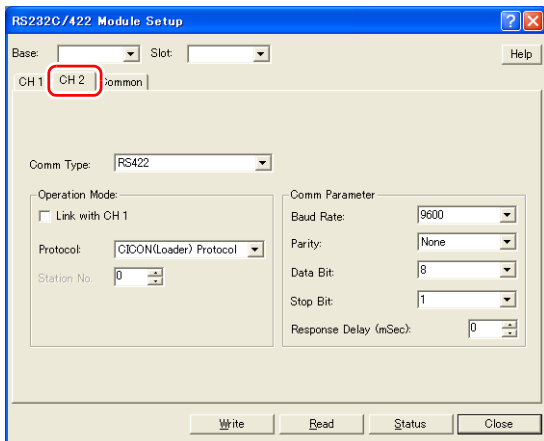

Item	Setting	Remarks
Comm Type	RS422 / RS485	RS-422: 4-wire RS-485: 2-wire
Protocol	CICON(Loader) Protocol	
Baud Rate	9600 / 19200 / 38400 bps	
Parity	Even / Odd / None	
Data Bit	7 / 8 bits	
Stop Bit	1 / 2 bits	

Available Memory

The available memory setting range varies depending on the PLC model. Be sure to set within the range available for the PLC. Use [TYPE] when assigning the indirect memory for macro programs.

Memory	TYPE	Remarks
D (Data Memory)	00H	
X (External Input)	01H	
Y (External Output)	02H	
M (Internal Relay)	03H	
L (Internal Relay)	04H	
K (Latch Relay)	05H	
F (Flags)	06H	Read only
T (Timer Output)	07H	
TS (Timer SV)	08H	
TC (Timer PV)	09H	
C (Counter Output)	0AH	
CS (Counter SV)	0BH	
CC (Counter PV)	0CH	
S (Step Control Relay)	0DH	*1

*1 The addresses are expressed in "bytes". For word designation, specify an even-numbered address.

7.1.3 Wiring Diagrams

When Connected at COM1:

RS-422

Wiring diagram 1 - COM1

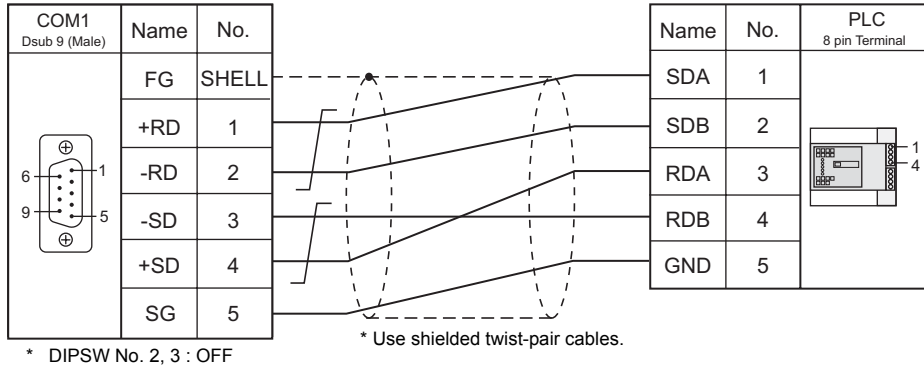

Wiring diagram 2 - COM1

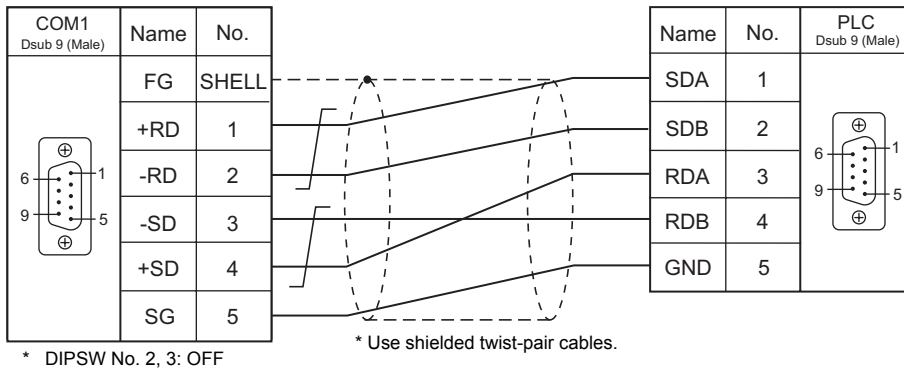

Wiring diagram 3 - COM1

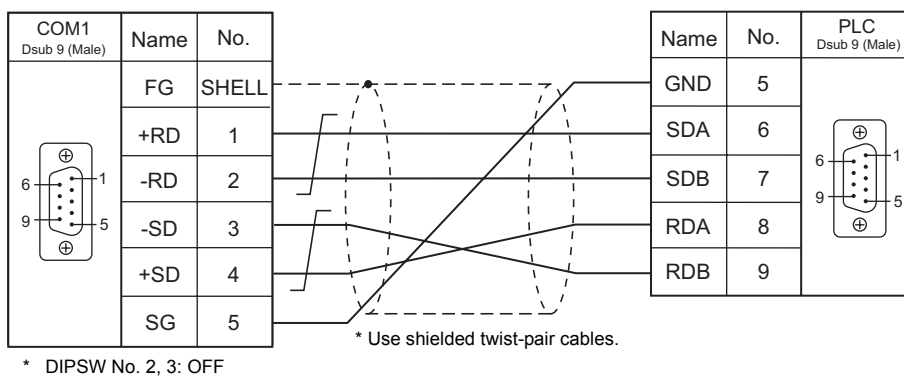

Wiring diagram 4 - COM1

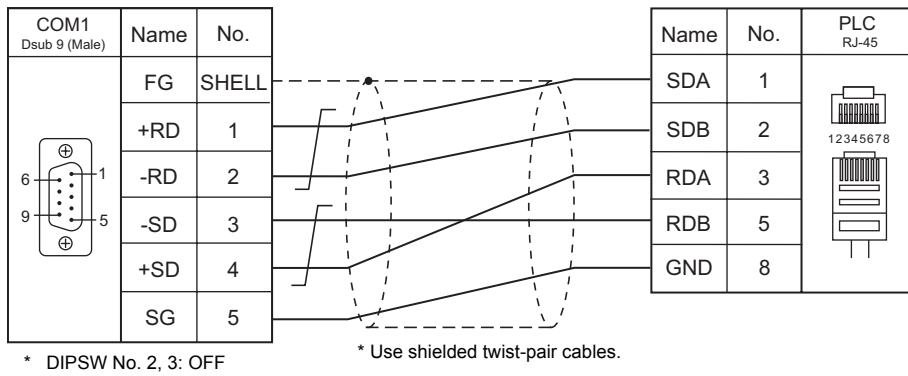

Wiring diagram 5 - COM1

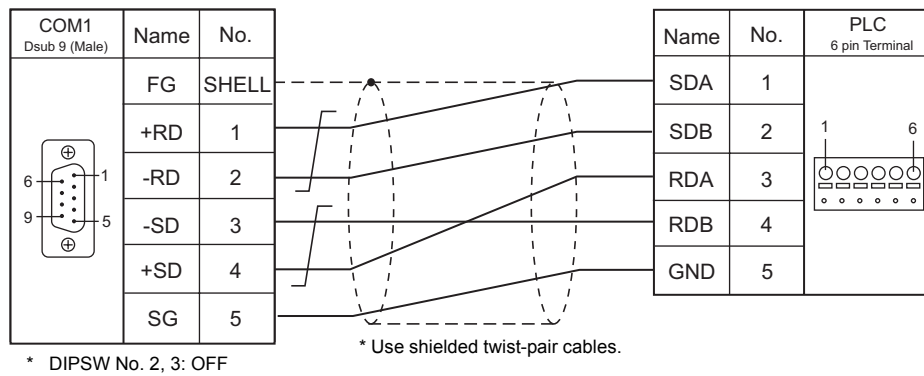

When Connected at COM2:

RS-232C

Wiring diagram 1 - COM2

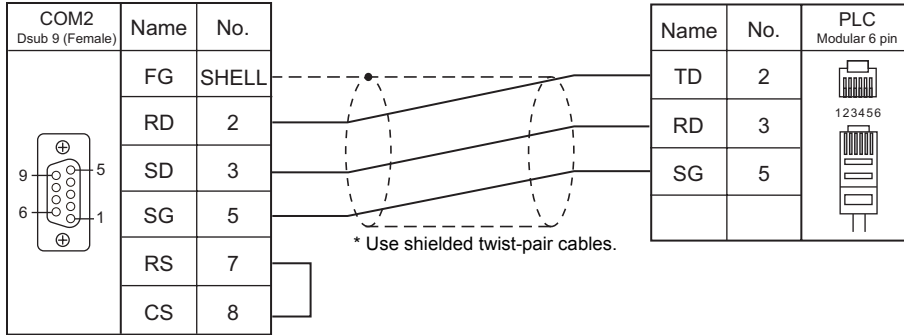

Wiring diagram 2 - COM2

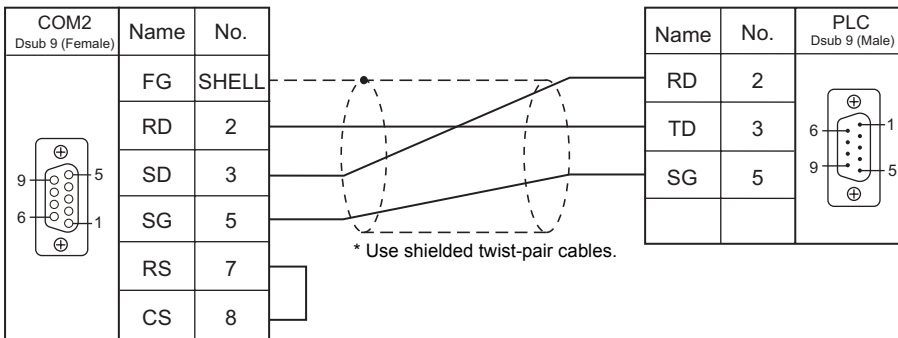

Wiring diagram 3 - COM2

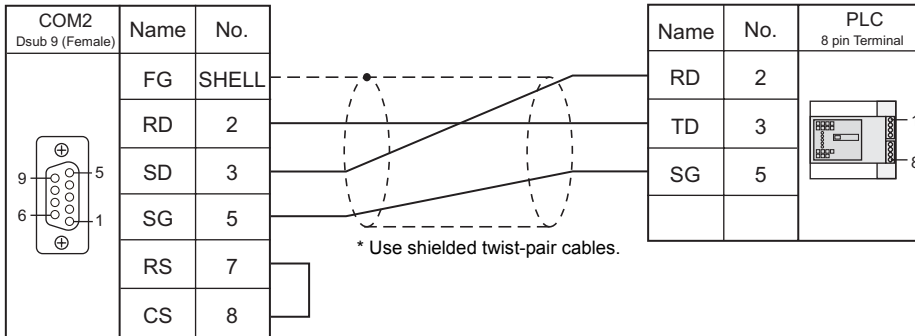

Wiring diagram 4 - COM2

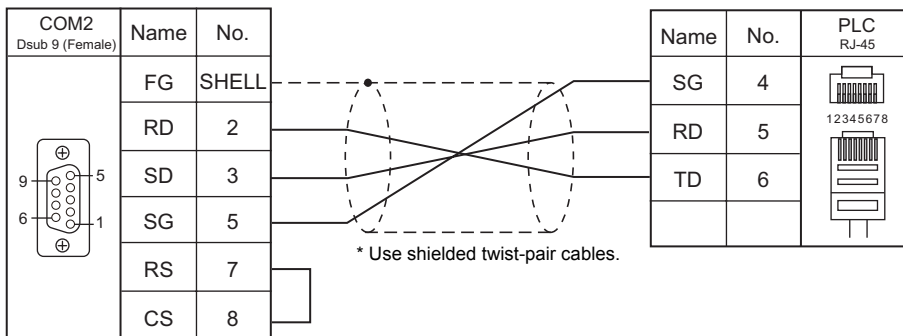

When Connected at COM3:

RS-485

Wiring diagram 1 - COM3

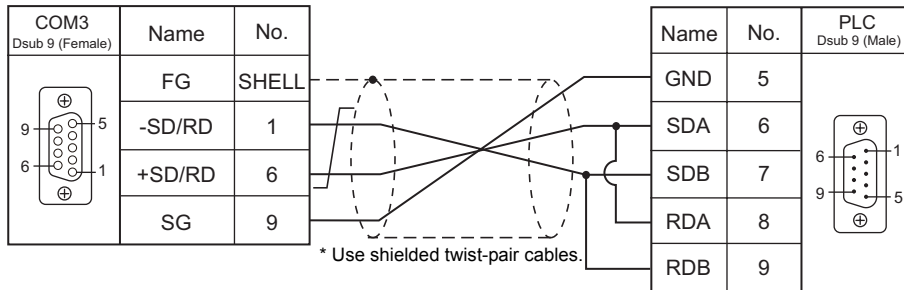

Wiring diagram 2 - COM3

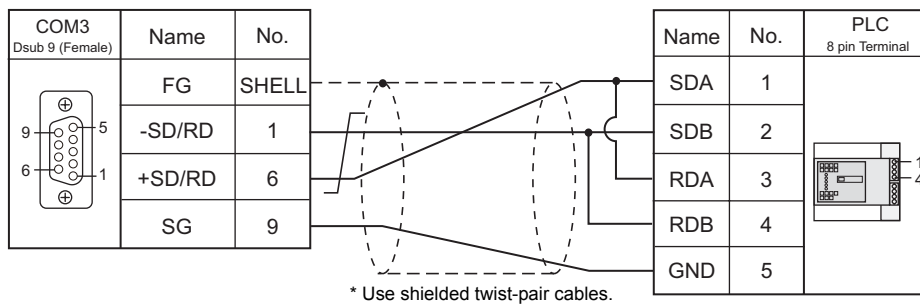

Wiring diagram 3 - COM3

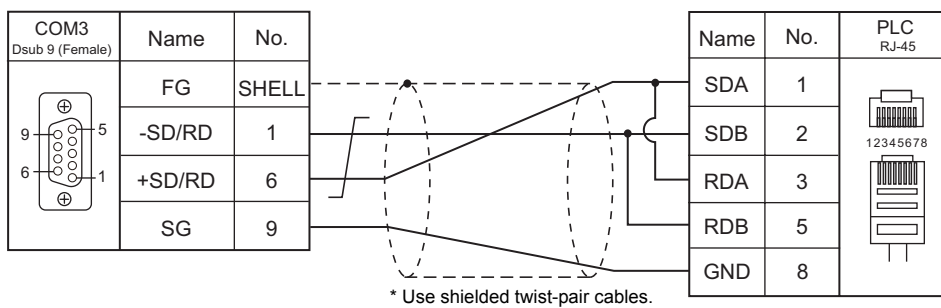

Wiring diagram 4 - COM3

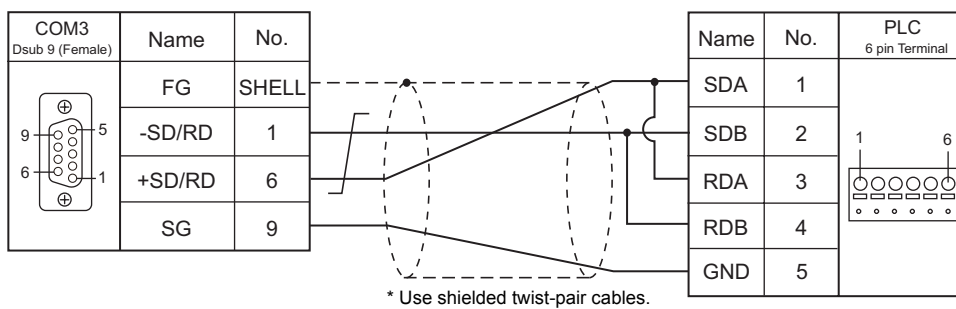

MEMO

Please use this page freely.

8. DELTA

8.1 PLC Connection

8.1 PLC Connection

Serial Connection

PLC Selection on the Editor	CPU	Unit/Port	Signal Level	TS Port	Connection	Ladder Transfer ^{*1}
DVP series	DVP-EH2 DVP-ES DVP-EX DVP-SS DVP-SA DVP-SX DVP-SC DVP-SV DVP-PM	RS-485 communication port	RS-485	COM1	Wiring diagram 1 - COM1	×
				COM3	Wiring diagram 1 - COM3	
		RS-232C communication port	RS-232C	COM2	Wiring diagram 1 - COM2	

*1 For the ladder transfer function, see "Appendix 5 Ladder Transfer Function".

8.1.1 DVP Series

Communication Setting

Editor

Communication setting

(Underlined setting: default)

Item	Setting	Remarks
Connection Mode	<u>1</u> : 1 / 1 : n / Multi-link2	
Signal Level	RS-232C / <u>RS-422/485</u>	
Baud Rate	<u>9600</u> / 19200 / 38400 / 57600 / 115200 bps	
Data Length	<u>7</u> / 8 bits	
Stop Bit	<u>1</u> / 2 bits	
Parity	None / Odd / <u>Even</u>	
Target Port No.	<u>1</u> to 31	

PLC

Item	Setting	Remarks
Baud rate	9600	For more information, refer to the PLC manual issued by the manufacturer.
Station number	1	
Data length	7	
Stop bit	1	
Parity	Even	

Available Memory

The available memory setting range varies depending on the PLC model. Be sure to set within the range available for the PLC. Use [TYPE] when assigning the indirect memory for macro programs.

Memory	TYPE	Remarks
D (Data register)	00H	
X (Input relay)	01H	Read only
Y (Output relay)	02H	
M (Auxiliary relay)	03H	
S	04H	
T (Timer)	05H	
C (Counter)	06H	
32C (High-speed counter)	07H	Double-word

8.1.2 Wiring Diagrams

When Connected at COM1:

RS-485

Wiring diagram 1 - COM1

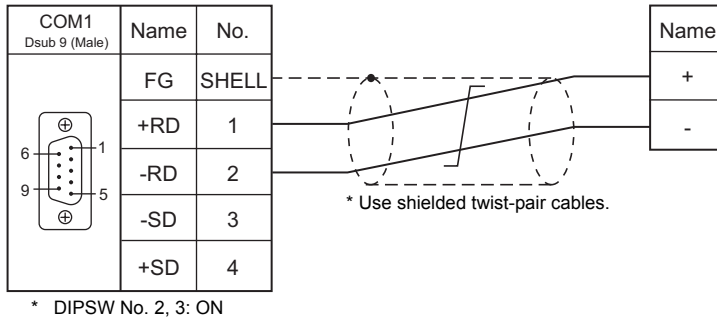

When Connected at COM2:

RS-232C

Wiring diagram 1 - COM2

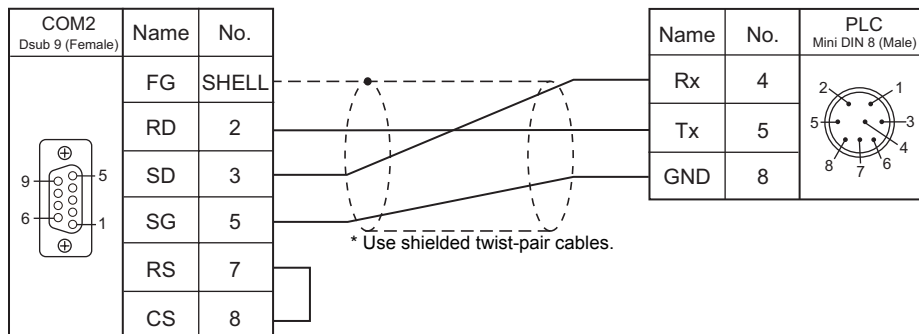

When Connected at COM3:

RS-485

Wiring diagram 1 - COM3

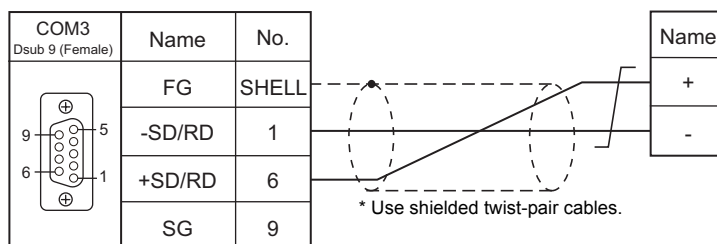

MEMO

Please use this page freely.

9. DELTA TAU DATA SYSTEMS

9.1 Temperature Controller/Servo/Inverter Connection

9.1 Temperature Controller/Servo/Inverter Connection

Serial Connection

Motion Controller

PLC Selection on the Editor	Model	Port		Signal Level	TS Port	Connection	Lst File
PMAC	PMAC PCI	Serial port	J4	RS-232C	COM2	Wiring diagram 1 - COM2	PMAC.Lst
	Turbo PMAC PCI	Option-9T	J8	RS-232C	COM2	Wiring diagram 2 - COM2	
	PMAC2 PCI	Serial port	J5				
	Turbo PMAC2 PCI	Option-9T	J8				
	UMAC Turbo CPU	Serial port	J7				
		Sub-serial port	J8				
	3U Turbo PMAC2	Serial port	J7	RS-232C	COM2	Wiring diagram 1 - COM2	
		Option-9T	J8	RS-232C	COM2	Wiring diagram 2 - COM2	

Ethernet Connection

Motion Controller

PLC Selection on the Editor	Model	Unit	TCP/IP	UDP/IP	Port No.	Lst File
PMAC (Ethernet TCP/IP)	UMAC Turbo CPU	CPU with built-in Ethernet	○	×	1025 (max. 4 units)	PMAC_Eth.Lst

9.1.1 PMAC

Communication Setting

Editor

Communication setting

(Underlined setting: default)

Item	Setting	Remarks
Connection Mode	<u>1</u> :1 / Multi-link2	
Signal Level	RS-232C	
Baud Rate	4800 / 9600 / 19200 / <u>38400</u> / 57600 / 76800 / 115K bps	
Data Length	8 bits	
Stop Bit	1 bit	
Parity	None	
Target Port No.	<u>0</u> to 31	

PMAC

Make PMAC settings by using the software "PEWIN32PRO2". For more information, refer to the PMAC instruction manual issued by the manufacturer.

Values after change are saved in FROM and determined when the power is turned off and back on again.

I-Variables By Number

Address	Contents	Setting
I0	Serial card number	0: 1:1 connection
I1	Serial port mode	0: CTS signal used
I3	Handshake I/O control	2
I4	Communication sum check mode	0: Without sum check
I6	Error notification mode	1
I43	Protocol selection *1	0: Standard protocol
I53	Sub port *2	Baud rate 6: 4800, 8: 9600, 10: 19200, 12: 38400, 13: 57600, 14: 78600, 15: 115K *3 bps
I54	Main port	Baud rate 6: 4800, 8: 9600, 10: 19200, 12: 38400, 13: 57600, 14: 78600, 15: 115K *3 bps
I63	Echo back selection	1: Valid



*1 Set when Turbo PMAC PCI, Turbo PMAC2 CPCI, UMAC Turbo CPU or 3U Turbo PMAC2 is used.

*2 Valid when "Option-9T" is used with Turbo PMAC PCI, Turbo PMAC2 CPCI / 3U Turbo PMAC2 or the sub port of UMAC Turbo CPU is used.

*3 When "115K bps" is set, set the multiples of 30 MHz for "I52" (CPU frequency).

PMAC PCI



MAIN BOARD E-POINT

E-POINT	Contents	Setting
 E49	Parity control for serial communication	No parity: Install a jumper between pins 1 and 2.
 E110	Serial port setting	RS-232C: Install a jumper between pins 1 and 2.

PMAC2 PCI**BASE BOARD E-POINT**

E-POINT	Contents	Setting
	E17 E18	Serial port type selection RS-232C: Install a jumper between pins 1 and 2.

Turbo PMAC PCI**MAIN BOARD E-POINT**

E-POINT	Contents	Setting
	E49	Parity control for serial communication No parity: Install a jumper between pins 1 and 2.
	E110	Serial port setting RS-232C: Install a jumper between pins 1 and 2.

Turbo PMAC2 PCI**BASE BOARD E-POINT**

E-POINT	Contents	Setting
	E17 E18	Serial port type selection RS-232C: Install a jumper between pins 1 and 2.

UMAC Turbo CPU**TURBO CPU BOARD E-POINT**

E-POINT	Contents	Setting
	E17A	PHASE+ valid/invalid Invalid: Install a jumper between pins 1 and 2.
	E17B	PHASE- valid/invalid Invalid: Install a jumper between pins 1 and 2.
	E18A	SERVO+ valid/invalid Invalid: Install a jumper between pins 1 and 2.
	E18B	SERVO- valid/invalid Invalid: Install a jumper between pins 1 and 2.

3U Turbo MPMAC2**TURBO CPU BOARD E-POINT**

E-POINT	Contents	Setting
	E17 E18	Serial port selection RS-232C: Install a jumper between pins 1 and 2.

Available Memory

The available memory setting range varies depending on the device. Be sure to set within the range available with the device to be used. Use [TYPE] when assigning the indirect memory for macro programs.

Memory	TYPE	Remarks
P (variable P)	00H	Real number
Q (variable Q)	01H	Real number
M (variable M)	02H	Real number
I (variable I)	03H	Real number
M_INT (variable M (integer))	04H	Double-word
I_INT (variable I (integer))	05H	Double-word
P_INT (variable P (integer))	06H	Double-word

Indirect Memory Designation

	15	8	7	0
n + 0	Model		Memory type	
n + 1	Address No.			
n + 2	Expansion code *		Bit designation	
n + 3	00		Station number	

* In the expansion code, set which word, higher or lower, is to be read when a double-word address is specified (expansion bit designation).

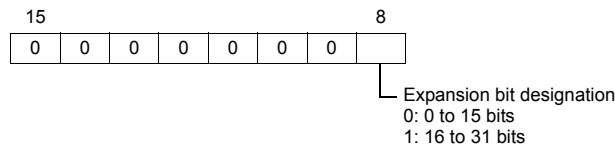

PLC_CTL

Macro command "PLC_CTL F0 F1 F2"

Contents	F0	F1 (= \$u n)	F2
Write of data	1 - 8 (PLC1 - 8)	n	Station number
		n + 1	Command: 0000H
		n + 2	Timeout time: 1 to 300 sec. (0: Time set on the editor*)
Control-X	1 - 8 (PLC1 - 8)	n	Station number
		n + 1	Command: 0001H

* Depends on the time set for [Time-out Time] in the [Communication Setting] tab window ([System Setting] → [Device Connection Setting]).

9.1.2 PMAC (Ethernet TCP/IP)

Communication Setting

Editor

Make the following settings on the editor. For more information, see Appendix 2 Ethernet.

- IP address for the TS unit
 - When specified on the screen data:
[System Setting] → [Ethernet Communication] → [Local Port IP Address]
 - When specified on the TS unit:
Main Menu screen → [Ethernet]
- Port number for the TS unit (for communication with PLC)
[System Setting] → [Device Connection Setting] → [Communication Setting]

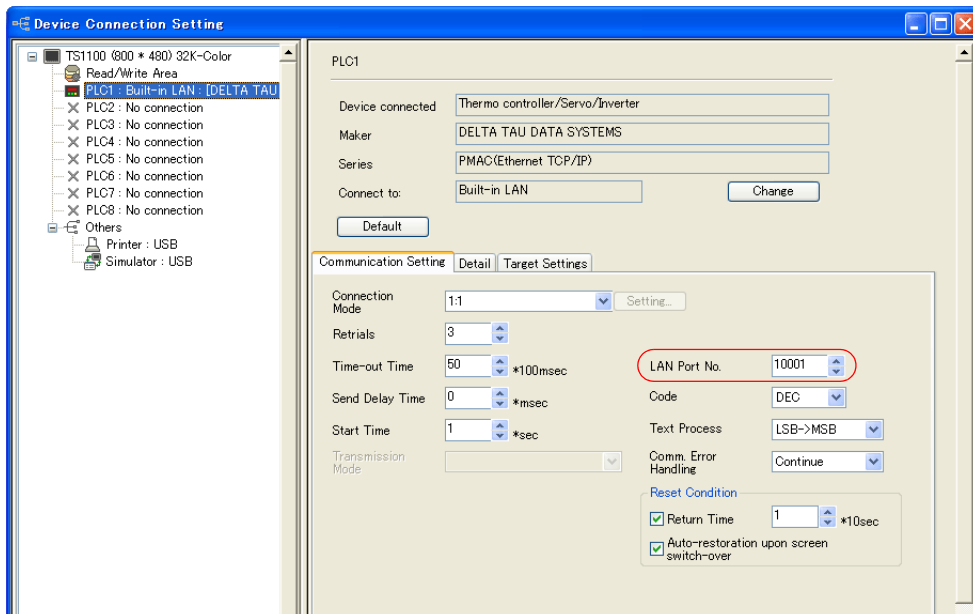

- IP address and port number of the PLC
[System Setting] → [Device Connection Setting] → [PLC Table]

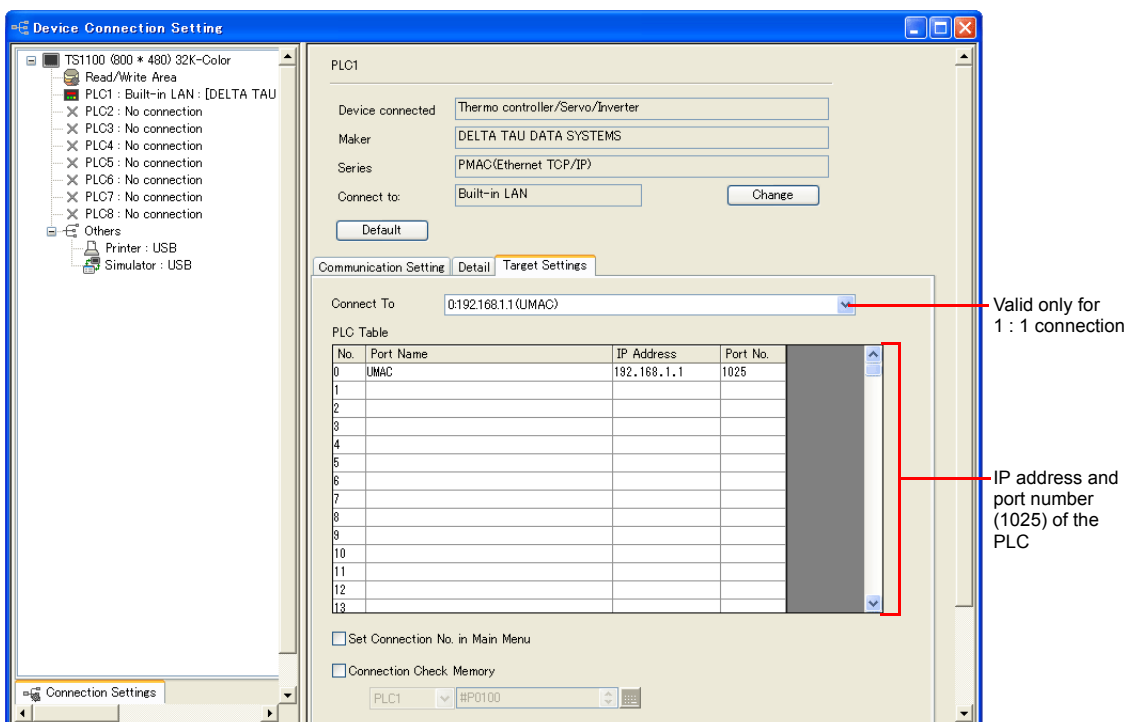

UMAC

Make UMAC settings by using the software "PEWIN32PRO2 *". For more information, refer to the UMAC manual issued by the manufacturer.

* For Ethernet communication, PEWIN32PRO service pack 2.0 and later is necessary.

Ethernet Configuration

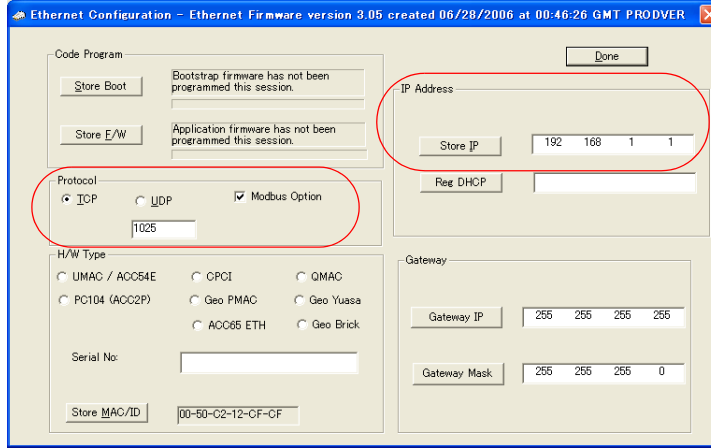

Item	Setting	Remarks
Protocol	TCP	For more information, refer to the UMAC instruction manual.
	Port No. 1025 (fixed)	
IP Address	IP address of UMAC	

Procedure for changing the IP address

1. Change the IP address on the [Ethernet Configuration] dialog.
2. Click [Store IP] on the [Ethernet Configuration] dialog.

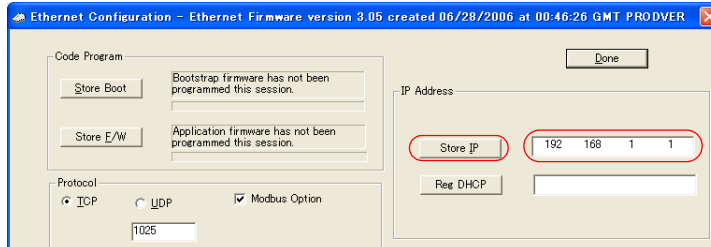

3. The [Ethernet Configure] dialog is displayed. Click [Yes].

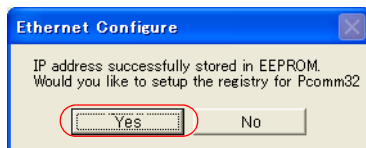

4. The [Dialog] dialog is displayed. Set "0" for [Card Instance] and click [OK].

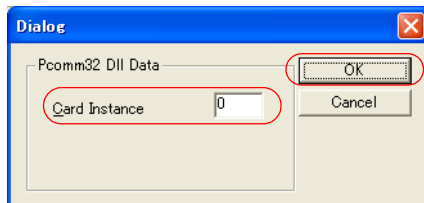

- The [ETHUSBConfigure] dialog is displayed.
Click [OK].

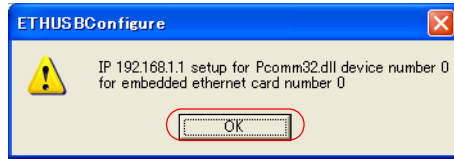

- The [Ethernet Configuration] dialog is displayed again.
Click [Done] in the dialog.

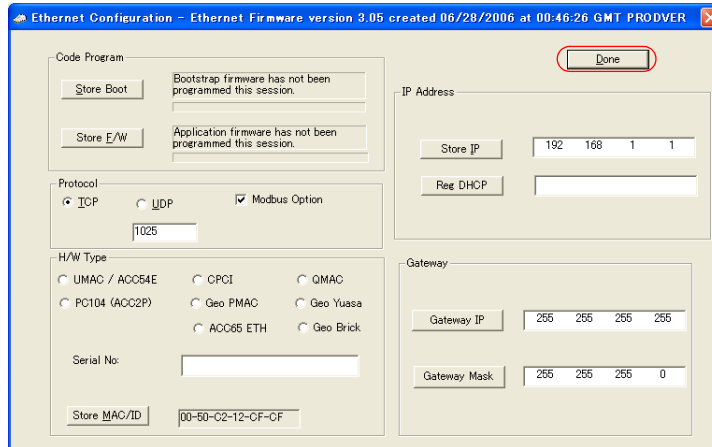

- Turn the power off and back on again.

* UMAC settings must be made via USB communication.
Before performing Ethernet communication with TS series, turn the power to UMAC off and remove the USB cable. Then, insert the Ethernet cable and turn the power on again.

I-Variables By Number

Address	Contents	Setting
I3	Handshake I/O control	2
I6	Error notification mode	1
I63	<Control-X> Echo valid/invalid	1: Valid

* Values after change are saved in FROM and determined when the power is turned off and back on again.

UMAC Turbo CPU

TURBO CPU BOARD E-POINT

E-POINT	Contents	Setting
 E6	Reloading the micro controller firmware	Normal operation: Install a jumper between pins 1 and 2.

Available Memory

The available memory setting range varies depending on the device. Be sure to set within the range available with the device to be used. Use [TYPE] when assigning the indirect memory for macro programs.

Memory	TYPE	Remarks
P (variable P)	00H	Real number
Q (variable Q)	01H	Real number
M (variable M)	02H	Real number
I (variable I)	03H	Real number
M_INT (variable M (integer))	04H	Double-word
I_INT (variable I (integer))	05H	Double-word
P_INT (variable P (integer))	06H	Double-word

Indirect Memory Designation

	15	8	7	0
n + 0	Model		Memory type	
n + 1	Address No.			
n + 2	Expansion code *		Bit designation	
n + 3	00		Station number	

* In the expansion code, set which word, higher or lower, is to be read when a double-word address is specified (expansion bit designation).

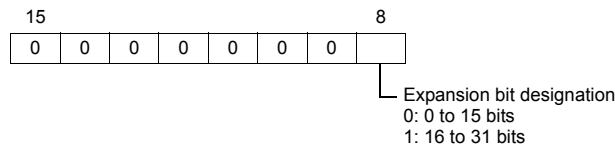

PLC_CTL

Macro command "PLC_CTL F0 F1 F2"

Contents	F0	F1 (= \$u n)	F2
Write of data	1 - 8 (PLC1 - 8)	n	Station number
		n + 1	Command: 0000H
		n + 2	Timeout time: 1 to 300 sec. (0: Time set on the editor*)
Control-X	1 - 8 (PLC1 - 8)	n	Station number
		n + 1	Command: 0001H

* Depends on the time set for [Time-out Time] in the [Communication Setting] tab window ([System Setting] → [Device Connection Setting]).

9.1.3 Wiring Diagrams

When Connected at COM2:

RS-232C

Wiring diagram 1 - COM2

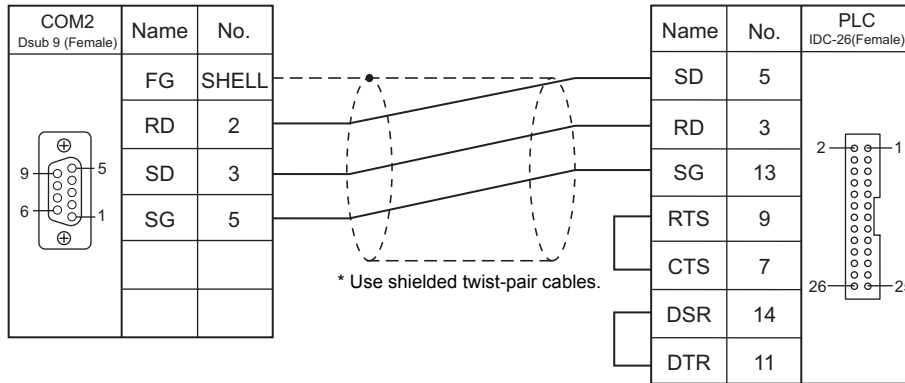

Wiring diagram 2 - COM2

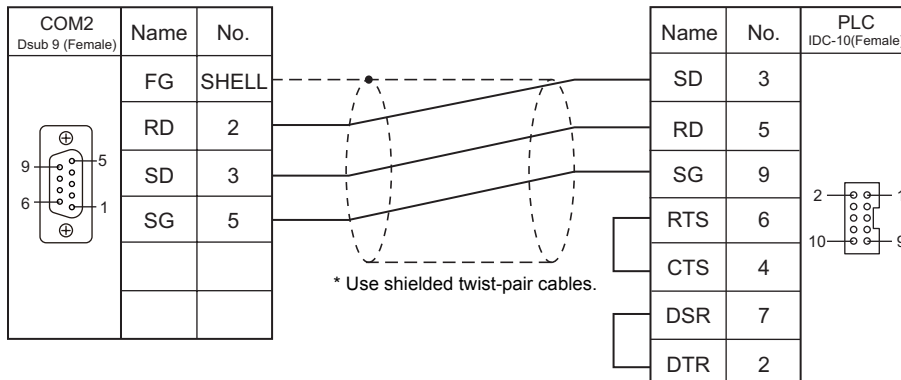

MEMO

Please use this page freely.

10. EATON Cutler-Hammer

10.1 PLC Connection

10.1 PLC Connection

The PLC models shown below can be connected.

Serial Connection

PLC Selection on the Editor	CPU	Unit/Port	Signal Level	TS Port	Connection	Ladder Transfer ^{*1}
ELC	ELC-PA10 ELC-PC12 ELC-PH12 ELC-PB14	Programming port on the CPU unit (COM1)	RS-232C	COM2	Wiring diagram 1 - COM2	×
		Communication port on the CPU unit (COM2)	RS-485	COM1	Wiring diagram 1 - COM1	
				COM3	Wiring diagram 1 - COM3	

*1 For the ladder transfer function, see "Appendix 5 Ladder Transfer Function".

10.1.1 ELC

Communication Setting

Editor

Communication setting

(Underlined setting: default)

Item	Setting	Remarks
Connection Mode	<u>1</u> :1 / 1:n / Multi-link2	
Signal Level	RS-232C / <u>RS-422/485</u>	
Baud Rate	4800 / <u>9600</u> / 19200 / 38400 / 57600 / 115200 bps	
Data Length	<u>7</u> / 8 bits	
Stop Bit	<u>1</u> / 2 bits	
Parity	None / Odd / <u>Even</u>	
Target Port No.	<u>1</u> to 31	

PLC

Make the PLC setting using data register memory "D". For more information, refer to the PLC manual issued by the manufacturer.

Available Memory

The available memory setting range varies depending on the PLC model. Be sure to set within the range available for the PLC. Use [TYPE] when assigning the indirect memory for macro programs.

	Memory	TYPE	Remarks
D	(data register)	00H	
X	(input)	01H	Read only
Y	(output)	02H	
M	(auxiliary relay)	03H	
S	(step point)	04H	
T	(timer)	05H	
C	(counter)	06H	
32C	(high-speed counter)	07H	Double-word

10.1.2 Wiring Diagrams

When Connected at COM1:

RS-485

Wiring diagram 1 - COM1

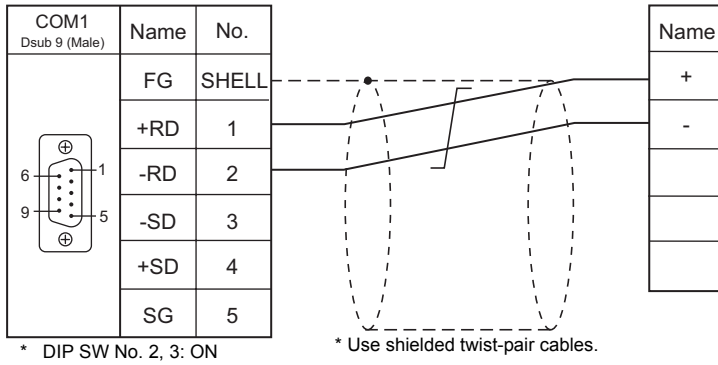

When Connected at COM2:

RS-232C

Wiring diagram 1 - COM2

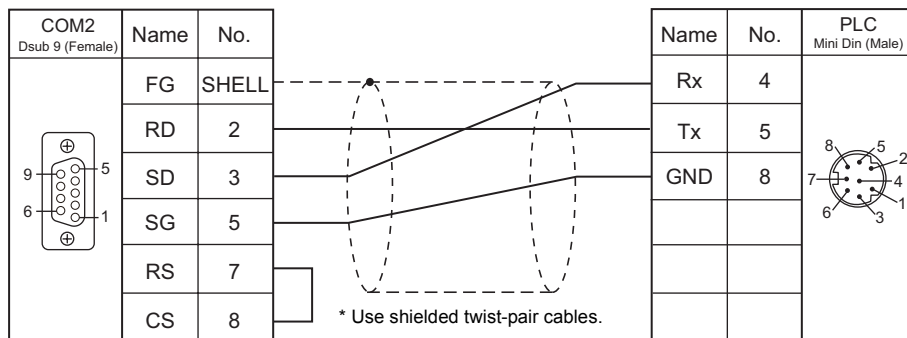

When Connected at COM3:

RS-485

Wiring diagram 1 - COM3

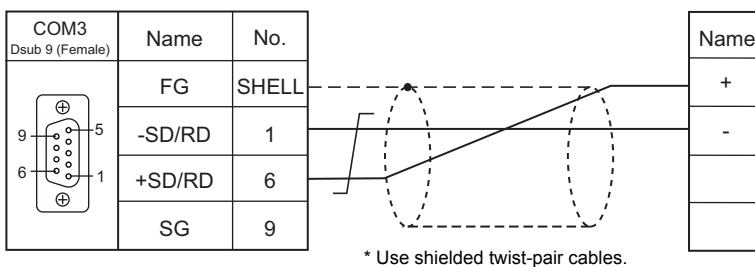

MEMO

Please use this page freely.

11. EMERSON

11.1 PLC Connection

11.1 PLC Connection

Serial Connection

PLC Selection on the Editor	CPU	Unit/Port	Signal Level	TS Port	Connection	Ladder Transfer ^{*1}
EC10/EC20/EC20H (MODBUS RTU)	EC10	Port1 ^{*2}	RS-232C	COM2	Wiring diagram 1 - COM2	×
			RS-485	COM1	Wiring diagram 1 - COM1	
				COM3	Wiring diagram 1 - COM3	
	EC20	COM2 ^{*2}	RS-232C	COM2	Wiring diagram 1 - COM2	
			RS-485	COM1	Wiring diagram 1 - COM1	
				COM3	Wiring diagram 1 - COM3	

*1 For the ladder transfer function, see "Appendix 5 Ladder Transfer Function".

*2 The concurrent use of RS-232C and RS-485 terminals is not allowed for connection.

11.1.1 EC10/EC20/EC20H (MODBUS RTU)

Communication Setting

Editor

Communication setting

(Underlined setting: default)

Item	Setting	Remarks
Connection Mode	<u>1</u> : 1 / 1:n / Multi-link2 / Multi-link2 (Ethernet)	
Signal Level	<u>RS-232C</u> / RS-422/485	
Baud Rate	4800 / 9600 / <u>19200</u> / 38400 bps	
Data Length	8 bits	
Stop Bit	<u>1</u> / 2 bits	
Parity	Odd / <u>Even</u> / None	
Target Port No.	<u>1</u> to 247	

PLC

Be sure to match the settings to those made on the [Communication Setting] tab window of the editor.

Calendar

This model is equipped with a calendar function; however, the calendar data cannot be written from the TS series. Thus, time correction must be performed on the controller side.

Available Memory

The available memory setting range varies depending on the PLC model. Be sure to set within the range available for the PLC. Use [TYPE] when assigning the indirect memory for macro programs.

Memory	TYPE	Remarks
D (Data register)	00H	
SD (Special data register)	01H	
Y (Output I/O)	02H	
X (Input I/O)	03H	
M (Auxiliary relay)	04H	
SM (Special auxiliary relay)	05H	
S (State relay)	06H	
T (Timer)	07H	
C (Counter)	08H	
Z (Offset addressing register)	09H	
TW (Timer)	0AH	
CW (Counter)	0BH	
CDW (Counter)	0CH	Double-word
R (R)	0DH	

Indirect Memory Designation

	15	8 7	0
n+0	Model		Memory type
n+1	Address No.		
n+2	Expansion code *		Bit designation
n+3	00		Station number

* For bit designation, an expansion code setting is required.

00H: when designating bit 0 to 15

01H: when designating bit 16 to 31

11.1.2 Wiring Diagrams

When Connected at COM1:

RS-485

Wiring diagram 1 - COM1

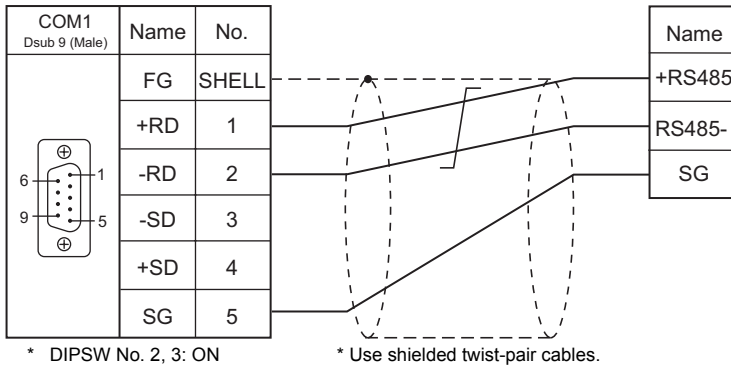

When Connected at COM2:

RS-232C

Wiring diagram 1 - COM2

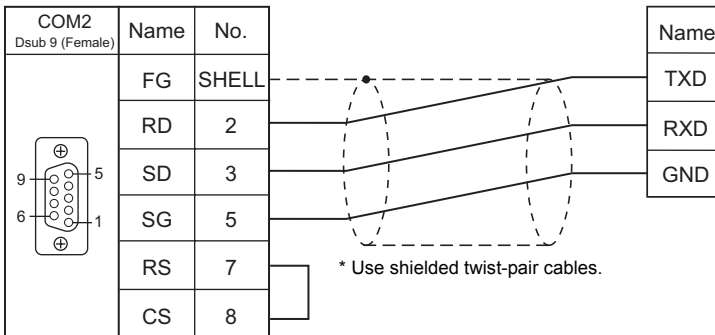

When Connected at COM3:

RS-485

Wiring diagram 1 - COM3

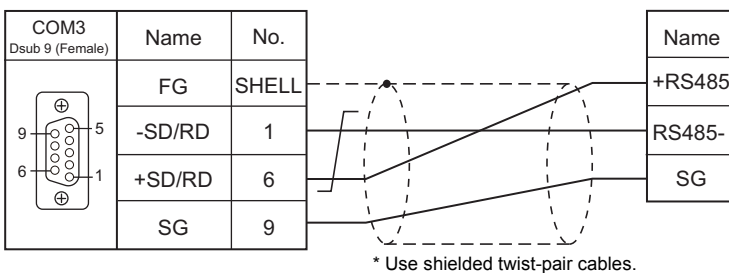

MEMO

Please use this page freely.

12. FANUC

12.1 PLC Connection

12.1 PLC Connection

Serial Connection

PLC Selection on the Editor	CPU	Port	Signal Level	TS Port	Connection	Ladder Transfer ^{*1}
Power Mate	Power Mate Model H/D	JD14	RS-422	COM1	Wiring diagram 1 - COM1	×
	Power Mate i Model H/D	JD40	RS-422	COM1	Wiring diagram 2 - COM1	
		JD42	RS-232C	COM2	Wiring diagram 1 - COM2	
	16-Model C	JD5B	RS-232C	COM2	Wiring diagram 2 - COM2	
	16i-Model A 16i-Model B 18i-Model A 18i-Model B 18-Model C 21i-Model A 21i-Model B	JD36B	RS-232C			
	30i-Model A 31i-Model A 32i-Model A	JD36A	RS-232C			
		JD54		COM2	Wiring diagram 3 - COM2	

*1 For the ladder transfer function, see "Appendix 5 Ladder Transfer Function".

12.1.1 Power Mate

Communication Setting

Editor

Communication setting

(Underlined setting: default)

Item	Setting	Remarks
Connection Mode	<u>1:1</u> / Multi-link2	
Signal Level	RS-232C / <u>RS-422/485</u>	
Baud Rate	19200 bps (fixed)	
Data Length	8 bits (fixed)	
Stop Bit	1 bit (fixed)	
Parity	Even (fixed)	

Available Memory

The available memory setting range varies depending on the PLC model. Be sure to set within the range available for the PLC. Use [TYPE] when assigning the indirect memory for macro programs.

Memory	TYPE	Remarks
D (data table)	00H	
X (input relay)	01H	WX as word device
Y (output relay)	02H	WY as word device
R (internal relay)	03H	WR as word device
K (keep relay)	04H	WK as word device
T (timer)	05H	
C (counter)	06H	
E (extensional relay)	07H	WE as word device, available only with 30i/31i/32i-ModelA

12.1.2 Wiring Diagrams

When Connected at COM1:

RS-422

Wiring diagram 1 - COM1

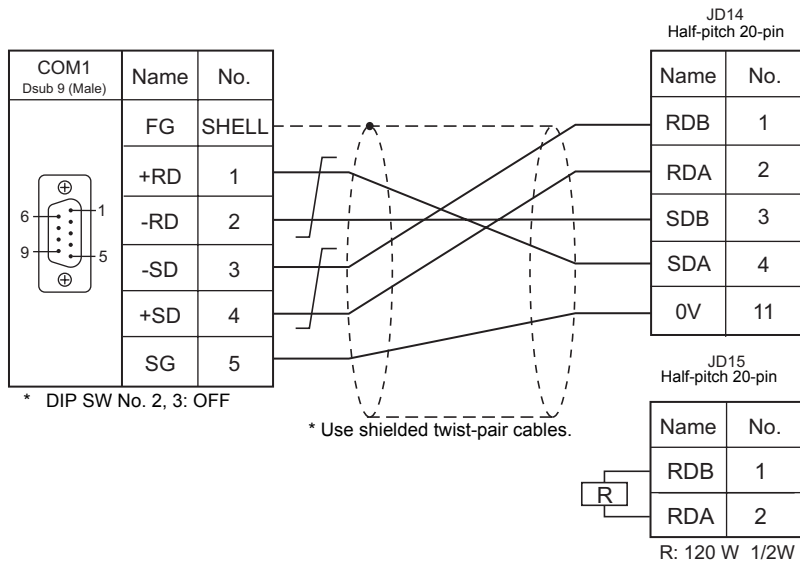

Wiring diagram 2 - COM1

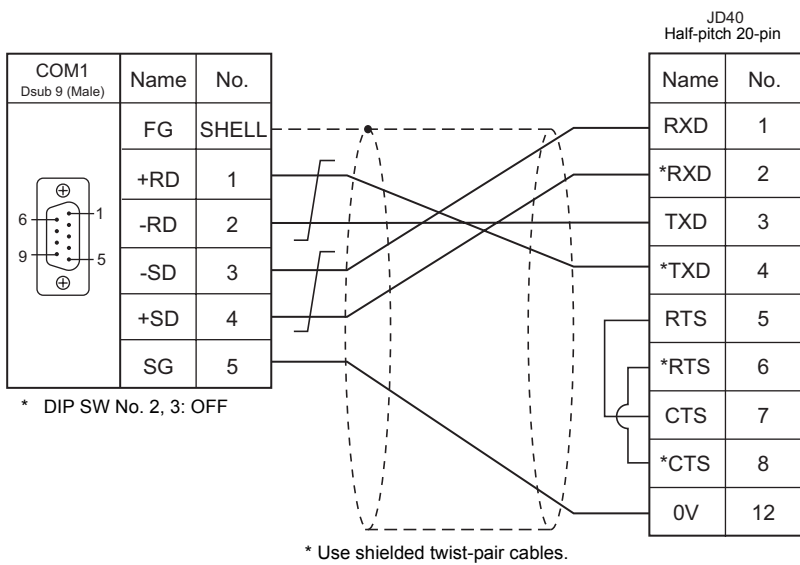

When Connected at COM2:

RS-232C

Wiring diagram 1 - COM2

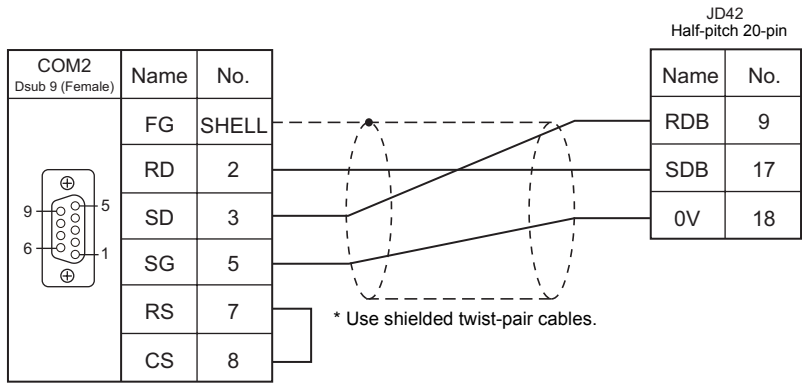

Wiring diagram 2 - COM2

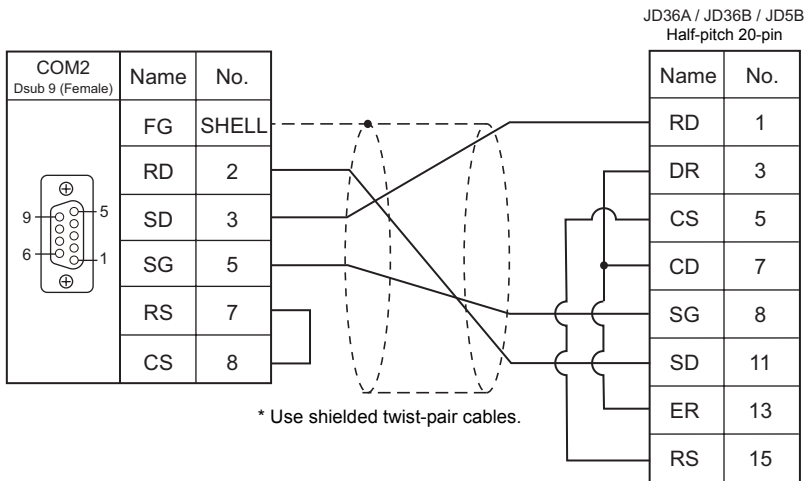

Wiring diagram 3 - COM2

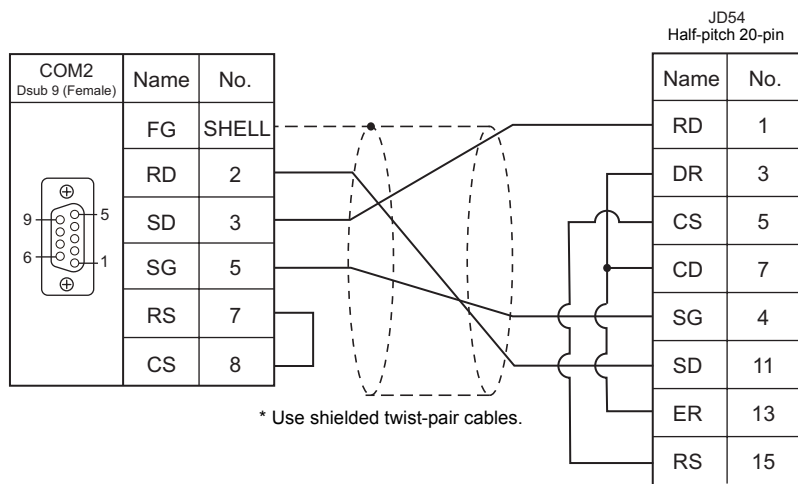

13. Fatek Automation

13.1 PLC Connection

13.1 PLC Connection

Serial Connection

PLC Selection on the Editor	CPU	Unit/Port		Signal Level	TS Port	Connection	Ladder Transfer ^{*1}
FACON FB series	FBE-20MC FBE-28MC FBE-40MC	CPU unit Programming port	Port1	RS-232C	COM2	Wiring diagram 1 - COM2	×
			Port2	RS-485	COM1	Wiring diagram 1 - COM1	
				COM3	Wiring diagram 1 - COM3		
		FB-DTBR	Port1 (D-sub 15)	RS-232C	COM2	Wiring diagram 1 - COM2	
			Port1 (D-sub 9)	RS-232C	COM2	Wiring diagram 2 - COM2	
			Port2 (terminal block)	RS-485	COM1	Wiring diagram 2 - COM1	
				COM3	Wiring diagram 2 - COM3		

*1 For the ladder transfer function, see "Appendix 5 Ladder Transfer Function".

13.1.1 FACON FB Series

Communication Setting

Editor

Communication setting

(Underlined setting: default)

Item	Setting	Remarks
Connection Mode	<u>1</u> : 1 / 1 : n / Multi-link2	
Signal Level	<u>RS-232C</u> / RS-422/485	
Baud Rate	<u>9600</u> / 19200 / 38400 bps	
Data Length	<u>Z</u> / 8 bits	
Stop Bit	<u>1</u> / 2 bits	
Parity	None / Odd / <u>Even</u>	
Target Port No.	<u>1</u> to 31	

PLC

Make the PLC setting using the configuration tool "PRO_LADDER". For more information, refer to the PLC manual issued by the manufacturer.

Available Memory

The available memory setting range varies depending on the PLC model. Be sure to set within the range available for the PLC. Use [TYPE] when assigning the indirect memory for macro programs.

Memory	TYPE	Remarks
HR (data register)	00H	
DR (data register)	01H	
X (input relay)	02H	WX as word device
Y (output relay)	03H	WY as word device
M (internal relay)	04H	WM as word device
S (step relay)	05H	WS as word device
T (timer/contact)	06H	WT as word device
C (counter/contact)	07H	WC as word device
RT (timer/current value)	08H	
RC (counter/current value)	09H	
DRC (32-bit counter/current value)	0AH	*1

*1 For items where double-words can be used (Num. Display, Graph, Sampling), data is processed as double-words.
 For those where bits or words can be used, data is processed as words consisting of lower 16 bits.
 For input: Upper 16 bits are ignored.
 For output: "0" is written for upper 16 bits.

13.1.2 Wiring Diagrams

When Connected at COM1:

RS-485

Wiring diagram 1 - COM1

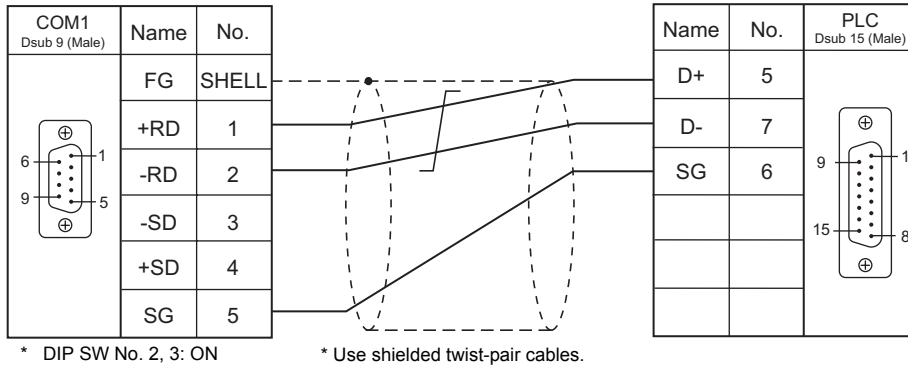

Wiring diagram 2 - COM1

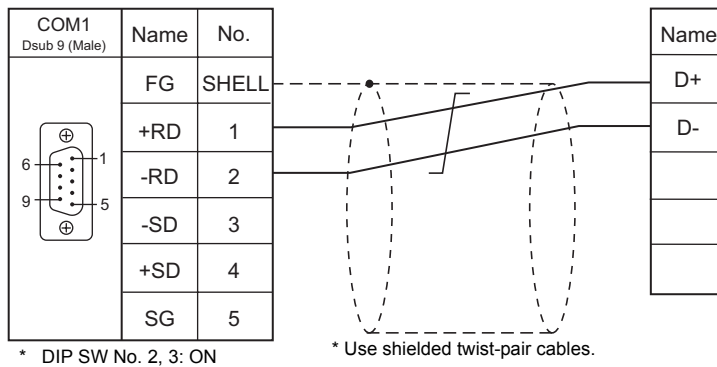

When Connected at COM2:

RS-232C

Wiring diagram 1 - COM2

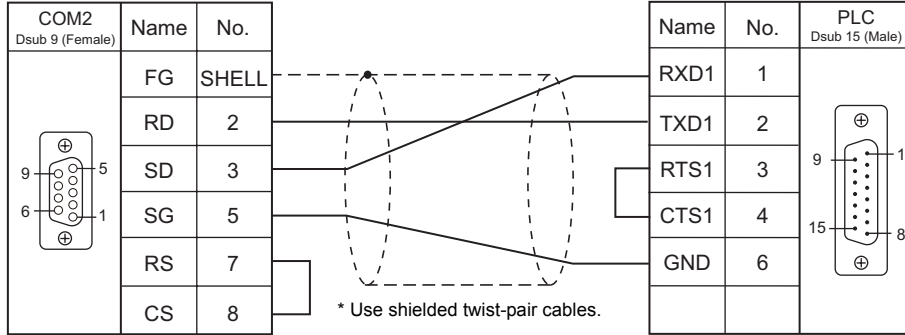

Wiring diagram 2 - COM2

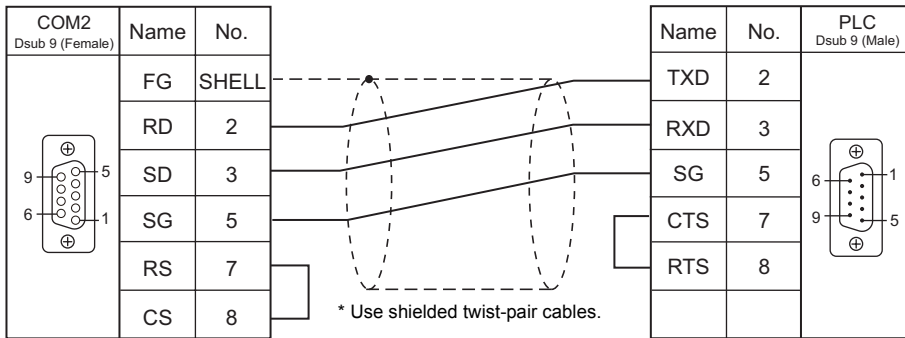

When Connected at COM3:

RS-485

Wiring diagram 1 - COM3

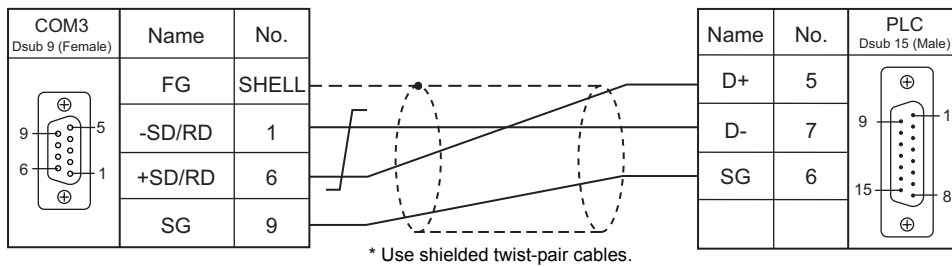

Wiring diagram 2 - COM3

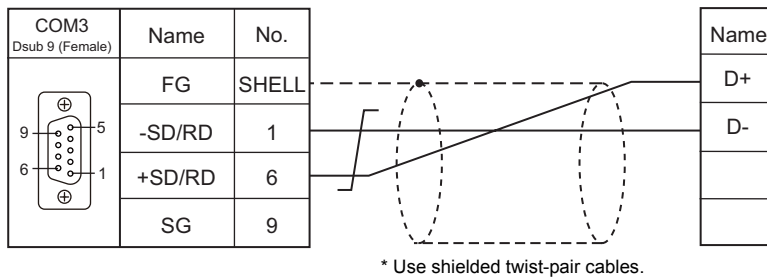

14. FUFENG

14.1 PLC Connection

14.1 PLC Connection

Serial Connection

PLC Selection on the Editor	CPU	Unit/Port	Signal Level	TS Port	Connection	Ladder Transfer *1
APC Series Controller	APB-50	COM1	RS-232C	COM2	Wiring diagram 1 - COM2	×
			RS-485	COM1	Wiring diagram 1 - COM1	
		COM3		Wiring diagram 1 - COM3		
		COM2	RS-232C	COM2	Wiring diagram 2 - COM2	

*1 For the ladder transfer function, see "Appendix 5 Ladder Transfer Function".

14.1.1 APC Series Controller

Communication Setting

Editor

Communication setting

(Underlined setting: default)

Item	Setting	Remarks
Connection Mode	<u>1</u> :1 / 1 : n / Multi-link2 / Multi-link2 (Ethernet) / 1 : n Multi-link2 (Ethernet)	
Signal Level	<u>RS-232C</u> / RS-422/485	
Baud Rate	4800 / 9600 / 19200 / 38400 / <u>115K</u> bps	
Data Length	<u>8</u> bits	
Stop Bit	<u>1</u> bit	
Parity	<u>None</u>	
Target Port No.	<u>0</u> to 98	

PLC

COM1

Communication setting

Make PLC settings using the application software "APC Pro". For more information, refer to the PLC manual issued by the manufacturer.

Item	Setting	Remarks
APC system	APC number setup	0 to 98
	APC baud rate setup	115200 / 38400 / 19200 / 9600 / 4800

Parity: none, data length: 8 bits, stop bit: 1 bit (fixed)

Signal level selection

Item	Setting	Remarks
Jumper	RS-232C	J1-1: Jumper across pins 2 and 3 J1-2: Jumper across pins 2 and 3 J1-3: Jumper across pins 2 and 3
	RS-485	J1-1: Jumper across pins 1 and 2 J1-2: Jumper across pins 1 and 2 J1-3: Jumper across pins 1 and 2

COM2

Station number: 0, parity: none, data length: 8 bits, stop bit: 1 bit, baud rate: 115200 bps (fixed)

Calendar

This model is not equipped with the calendar function. Use the calendar function of the TS series.

Available Memory

The available memory setting range varies depending on the PLC model. Be sure to set within the range available for the PLC. Use [TYPE] when assigning the indirect memory for macro programs.

Memory	TYPE	Remarks
D (Data area)	00H	
T (Timer relay area)	01H	Read only
C (Counter relay area)	02H	Read only
R (Accessory relay area)	03H	Common to D0 to D15 *1
X (Input channel)	04H	Common to D16 to D30 *1
Y (Output channel)	05H	Common to D31 to D40 *1
S (System relay area)	06H	Common to D41 to D55 *1
K (Thermal control relay area)	07H	Common to D56 to D63 *1
TSW (Timer setting area)	08H	Common to D208 to D335
TP (Present timer setting area)	09H	Read only, common to D336 to D463
CSW (Counter setting area)	0AH	Common to D464 to D591
CP (Present counter setting area)	0BH	Read only, common to D592 to D719
KJS (Thermal control temperature setting)	0CH	Common to D80 to D95
KP (Present thermal control temperature setting)	0DH	Read only, common to D96 to D111
KJL (Thermal control low-temperature alarm setting)	0EH	Common to D112 to D127
KJH (Thermal control high-temperature alarm setting)	0FH	Common to D128 to D143
KI (Present thermal control current setting)	10H	Read only, common to D144 to D159
KJC (Insufficient thermal control)	11H	Common to D160 to D175
KJR (Thermal control cycle setting)	12H	Common to D192 to D207

*1 When using consecutive bit devices, select device D for improved performance.

14.1.2 Wiring Diagrams

When Connected at COM1:

RS-485

Wiring diagram 1 - COM1

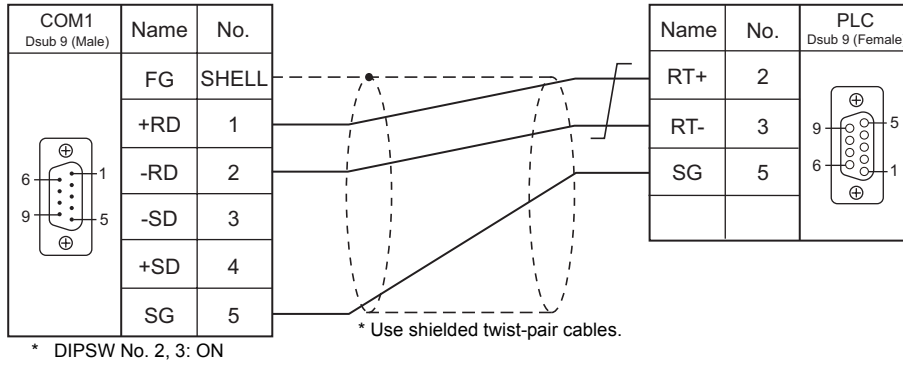

When Connected at COM2:

RS-232C

Wiring diagram 1 - COM2

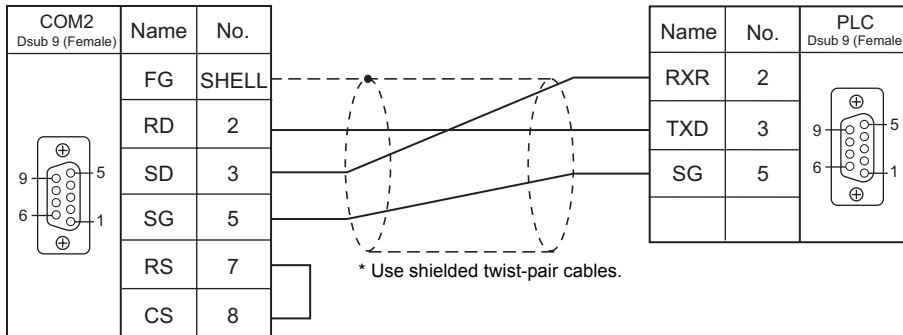

Wiring diagram 2 - COM2

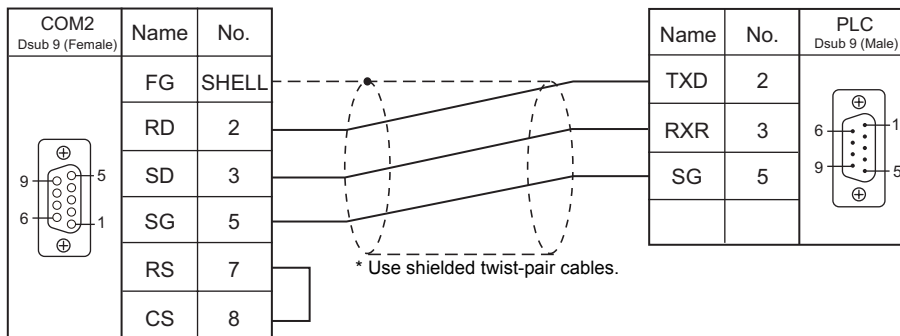

When Connected at COM3:

RS-485

Wiring diagram 1 - COM3

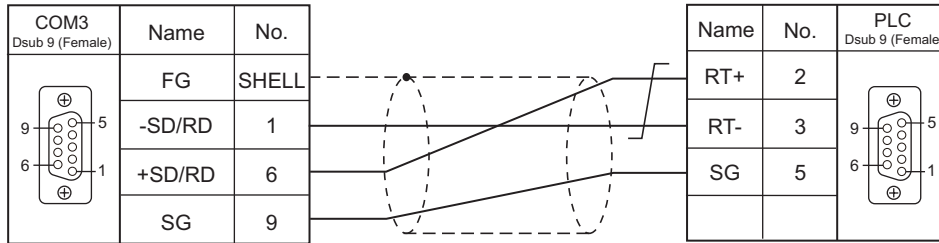

* Use shielded twist-pair cables.

MEMO

Please use this page freely.

15. Fuji Electric

15.1 PLC Connection

15.2 Temperature Controller/Servo/Inverter Connection

15.1 PLC Connection

The PLC models shown below can be connected.

Serial Connection

MICREX-F Series

PLC Selection on the Editor	CPU	Unit/Port	Signal Level	TS Port	Connection	Ladder Transfer ^{*1}
MICREX-F series	NV1P-x (F55)	NV1L-RS2	RS-232C	COM2	Wiring diagram 1 - COM2	×
	NC1P-E (F70) NC1P-S (F70S)	NC1L-RS2	RS-232C	COM2	Wiring diagram 1 - COM2	
		NC1L-RS4	RS-422	COM1	Wiring diagram 1 - COM1	
			RS-485	COM3	Wiring diagram 1 - COM3	
	FPU080H (F80H) FPU120H (F120H) FPU120S (F120S) FPU140S (F140S) FPU15xS (F15xS)	FFU120B	RS-232C	COM2	Wiring diagram 1 - COM2	
		FFK120A	RS-422	COM1	Wiring diagram 1 - COM1	
			RS-485	COM3	Wiring diagram 1 - COM3	

*1 For the ladder transfer function, see "Appendix 5 Ladder Transfer Function".

SPB (N Mode), FLEX-PC

PLC Selection on the Editor	CPU	Unit/Port	Signal Level	TS Port	Connection	Ladder Transfer ^{*1}
SPB (N mode) & FLEX-PC series	NS-CPU-xx	NS-RS1	RS-232C	COM2	Wiring diagram 1 - COM2	×
			RS-422	COM1	Wiring diagram 1 - COM1	
	NJ-CPU-xx	NJ-RS2	RS-232C	COM2	Wiring diagram 1 - COM2	
			NJ-RS4	RS-422	COM1	
	NBxx	NB-RS1	RS-232C	COM2	Wiring diagram 1 - COM2	
			RS-422	COM1	Wiring diagram 1 - COM1	
	NW0Pxx (SPB)	NW0LA-RS2	RS-232C	COM2	Wiring diagram 3 - COM2	
			RS-422	COM1	Wiring diagram 1 - COM1	
		NW0LA-RS4	RS-422	COM1	Wiring diagram 2 - COM1	
			RS-485	COM3	Wiring diagram 1 - COM3	
SPB (N Mode) & FLEX-PC CPU	NS-CPU-xx NJ-CPU-xx NBxx NW0Pxx (SPB)	CPU port	RS-422	COM1	Hakko Electronics "D9-FU-SPBCPU" ^{*2}	
	NJ-CPU-B16	RS-232C port	RS-232C	COM2	Wiring diagram 2 - COM2	

*1 For the ladder transfer function, see "Appendix 5 Ladder Transfer Function".

*2 Cable length: XXX-FU-SPBCPU-□M (□ = 2, 3, 5 m)

MICREX-SX, SPB (IEC Mode)

PLC Selection on the Editor	CPU	Unit/Port	Signal Level	TS Port	Connection	Ladder Transfer *1
MICREX-SX SPH/SPB series	NP1Px-xx (SPH)	NP1L-RS1	RS-232C	COM2	Wiring diagram 4 - COM2	×
			RS-422	COM1	Wiring diagram 3 - COM1	
		NP1L-RS2 , NP1L-RS3	RS-232C	COM2	Wiring diagram 4 - COM2	
			RS-422	COM1	Wiring diagram 3 - COM1	
	NW0Pxx (SPB)	NW0LA-RS2	RS-232C	COM2	Wiring diagram 3 - COM2	
			RS-422	COM1	Wiring diagram 1 - COM1	
MICREX-SX SPH/SPB CPU	NP1Px-xx (SPH)	CPU port	RS-422	COM1	Hakko Electronics "D9-FU-SPHCPU" *2	○
	NW0Pxx (SPB)	CPU port	RS-422	COM1	Hakko Electronics "D9-FU-SPBCPU" *2	

*1 For the ladder transfer function, see "Appendix 5 Ladder Transfer Function".

*2 Cable length: XXX-FU-SPHCPU-□M, XXX-FU-SPBCPU-□M (□ = 2, 3, 5 m)

Ethernet Connection

MICREX-SX Series

PLC Selection on the Editor	CPU	Unit	TCP/IP	UDP/IP	Port No.	Ladder Transfer
MICREX-SX (Ethernet)	NP1PH-xx (SPH200) NP1PS-xx (SPH300) NP1PM-xx (SPH2000)	NP1L-ET1	○	×	Self port standard No. + 251	×
	NP1PM-xx (SPH2000)	CPU with built-in Ethernet				

MICREX-SX Model Selection

When the MICREX-SX SPH or SPB series is connected, a mode selection may be required on the TS editor depending on the programming tool used on the PLC or the setting on the programming tool.

PLC	PLC Programming Tool		Setting on the TS Editor		
		Address Expression	PLC Selection	Mode Selection *2	
SPH series	SX-Programmer Expert (D300win)		MICREX-SX SPH/SPB series MICREX-SX SPH / SPB CPU MICREX-SX (Ethernet)	IEC Mode	
	SX-Programmer Standard (Ver. 1 / 2)	Unchecked *1		N Mode	
		Checked *1		F Mode	
	SX-Programmer Standard (Ver. 3)	FLEX-PC *1		N Mode	
MICREX-F *1		F Mode			
SPF series	SX-Programmer Expert (D300win)		MICREX-SX SPH/SPB series MICREX-SX SPH / SPB CPU	IEC Mode	
	SX-Programmer Standard (Ver. 1 / 2)	SX-MODE		Unchecked *1	N Mode
				Checked *1	F Mode
	SX-Programmer Standard (Ver. 3)	FLEX-PC *1		N Mode	
		MICREX-F *1		F Mode	
	SX-Programmer Standard (Ver. 1 / 2)	N-MODE		-	-
FLEX-PC Programmer	-	-	-		

*1 The setting procedure differs depending on the version of the SX-Programmer Standard tool.

- Ver. 1 or 2:

Check or uncheck the box for [Express address in MICREX-F address type] on the [Editor Options] tab window in the [Environment Options for MICREX-SX] dialog ([Options] → [MICREX-SX Environment]).

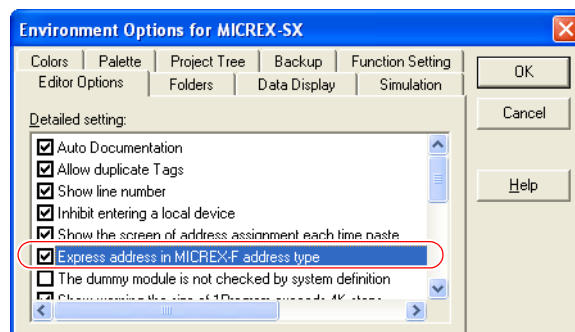

- Ver. 3:

Select "MICREX-F" from [Address display mode] ([Tool] → [Options] → [Category: General]).

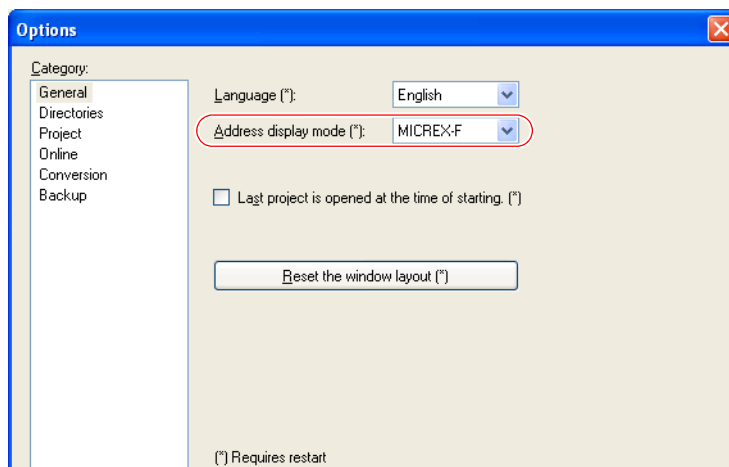

*2 [Mode Select] dialog on the TS editor

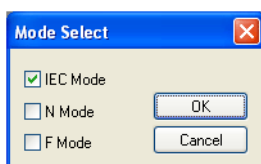

- [IEC Mode]: Variable name cooperation function
 - [N Mode]: Address denotation "hexadecimal" *
 - [F Mode]: Address denotation "decimal" *
- * Except bit addresses

15.1.1 MICREX-F Series

Communication Setting

Editor

Communication setting

(Underlined setting: default)

Item	Setting	Remarks
Connection Mode	<u>1</u> : 1 / 1 : n / Multi-link / Multi-link2	
Signal Level	<u>RS-232C</u> / RS-422/485	
Baud Rate	4800 / 9600 / <u>19200</u> bps	
Data Length	<u>7</u> / 8 bits	
Stop Bit	<u>1</u> / 2 bits	
Parity	None / Odd / <u>Even</u>	
Target Port No.	<u>0</u> to 31	

PLC

Be sure to match the settings to those made on the [Communication Setting] tab window of the editor.

Mode setting

MODE	Setting	Contents	
	1	RS-232C	Command-defined asynchronous communication (non-procedure)
	3	RS-485	Command-defined asynchronous communication (non-procedure)

* The mode setting switch is common to NV1L-RS2, NC1L-RS2, NC1L-RS4, FFU120B and FFK120A.

Station number setting

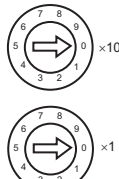
ADDRESS	Setting	Contents
	0 to 31	Station number ×10: the tens place ×1: the ones place

* The station number setting switch is common to NC1L-RS4, FFU120B and FFK120A.
It is not provided on NV1L-RS2 nor NC1L-RS2.

Transmission setting

NV1L-RS2, NC1L-RS2, NC1L-RS4, FFU120B

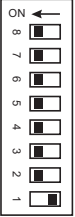
Switch	Contents	ON	OFF	E.g.) Editor Default Setting
8	Initializing method	Switch	Initial file	
7	Parity	Provided	Not provided	
6	Parity bit	Even	Odd	
5	Data bit length	7 bits	8 bits	
4	Stop bit length	1 bit	2 bits	
	Baud rate	19200	9600	
3		ON	ON	
2		ON	OFF	
1		OFF	ON	

FFK120A

- Character switches

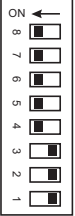
Switch	Contents	ON	OFF	E.g.) Editor Default Setting
8	Initializing method	Switch	Initial file	
7	Parity	Provided	Not provided	
6	Parity bit	Even	Odd	
5	Data bit length	7 bits	8 bits	
4	Stop bit length	2 bits	1 bit	
3	Not used	-	OFF	
2		-	OFF	
1		-	OFF	

- Baud rate setting switches
Set a switch to the ON position.

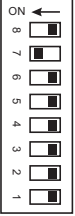
Switch	Contents	Example: 19,200 bps
8	Not used	
7	19,200 bps	
6	9,600 bps	
5	4,800 bps	
4	2,400 bps	
3	1,200 bps	
2	600 bps	
1	300 bps	

Available Memory

The available memory setting range varies depending on the PLC model. Be sure to set within the range available with the PLC to be used. Use [TYPE] when assigning the indirect memory for macro programs.

Memory	TYPE	Remarks
M (auxiliary relay)	00H	WM as word device
K (keep relay)	01H	WK as word device
B (input/output relay)	02H	WB as word device
L (link relay)	09H	WL as word device
F (special relay)	0AH	WF as word device
TS (timer/set value)	0BH	*1
TR (timer/current value)	0CH	*1
W9 (0.1-sec timer/current value)	0DH	*1
CS (counter/set value)	0EH	*1
CR (counter/current value)	0FH	*1
BD (data memory)	10H	*1
WS (step relay)	11H	*2
Wn (file memory)	12H	*3, *4

*1 For items where double-words can be used (Num. Display, Graph, Sampling), data is processed as double-words. For those where bits or words can be used, data is processed as words consisting of lower 16 bits.

For input: Upper 16 bits are ignored.

For output: "0" is written for upper 16 bits.

*2 Byte device such as step relay is processed as described below.

For input: Upper 8 bits are "0".

For output: Lower 8 bits are written.

*3 To set up the file memory on the editor, enter "file number" + ":" (colon) + "address" in order. Example: W30 : 00002

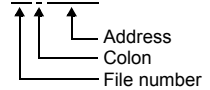

*4 Define the file area as "**SI**".

15.1.2 SPB (N Mode) & FLEX-PC Series

Communication Setting

Editor

Communication setting

(Underlined setting: default)

Item	Setting	Remarks
Connection Mode	<u>1</u> : 1 / 1 : n / Multi-link2	
Signal Level	<u>RS-232C</u> / RS-422/485	
Baud Rate	4800 / 9600 / <u>19200</u> / 38400 bps	
Data Length	<u>7</u> / 8 bits	
Stop Bit	<u>1</u> / 2 bits	
Parity	None / Odd / <u>Even</u>	
Target Port No.	<u>Q</u> to 31	

PLC

Be sure to match the settings to those made on the [Communication Setting] tab window of the editor.

NS-RS1, NJ-RS2, NJ-RS4, NB-RS1

Mode setting

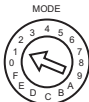
MODE	Setting	Contents	
	1	RS-232C	Command-defined asynchronous communication (non-procedure)
	3	RS-485	Command-defined asynchronous communication (non-procedure)

Station number setting

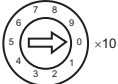
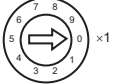
ADDRESS	Setting	Contents
 	0 to 31	Station number ×10: the tens place ×1: the ones place

* The station number setting switch is not provided on NJ-RS2.

Transmission setting

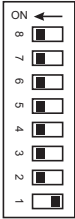
Switch	Contents	ON	OFF	E.g.) Editor Default Setting	
8	Initializing method	Switch	Initial file		
7	Parity	Provided	Not provided		
6	Parity bit	Even	Odd		
5	Data bit length	7 bits	8 bits		
4	Stop bit length	1 bit	2 bits		
3	Baud rate	19200	9600		
2		ON	ON		
1		ON	OFF		
1		OFF	ON		

NW0LA-RS2, NW0LA-RS4 (Parameter Setting)

On the PLC loader, set parameters for general communications.

Be sure to match the settings to those made on the [Communication Setting] tab window of the editor.

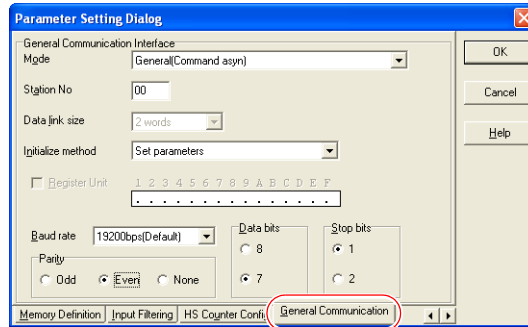

Item	Setting	Remarks
Mode	General (Command asyn)	These settings can also be specified for the parameter area. For more information, refer to the MICREX-SX SPB Series User's Manual <Communication Adapter> (FE405).
Station No.	RS-232C: 0, RS-485: 0 to 31	
Initialize method	Set parameters	
Baud rate	4800 / 9600 / 19200 / 38400	
Parity	Odd / Even / None	
Data bits	8 / 7	
Stop bits	1 / 2	

Notes on use of 2-wire connection with NW0LA-RS4

The settings show above are not enough to establish a 2-wire connection with NW0LA-RS4.

To establish a connection, select [Initial file transfer] for [Initial Setting Mode] on the PLC loader, and select 2-wire connection for [485 mode] in the initial setting file.

For more information, refer to the MICREX-SX SPB Series User's Manual <Communication Adapter> (FE405).

Available Memory

The available memory setting range varies depending on the PLC model. Be sure to set within the range available with the PLC to be used. Use [TYPE] when assigning the indirect memory for macro programs.

Standard Memory	TYPE	Remarks
D (data register)	00H	
W (link register)	01H	
M (internal relay)	02H	WM as word device
L (latch relay)	03H	WL as word device
X (input relay)	04H	WX as word device
Y (output relay)	05H	WY as word device
R (file register)	06H	
TN (timer/current value)	07H	
CN (counter/current value)	08H	
T (timer/contact)	09H	
C (counter/contact)	0AH	
WS (step relay)	0BH	

15.1.3 SPB (N Mode) & FLEX-PC CPU

Communication Setting

Editor

Communication setting

(Underlined setting: default)

Item	Setting	Remarks
Connection Mode	<u>1</u> :1 / Multi-link2	
Signal Level	RS-232C / <u>RS-422/485</u>	When connecting TS series to the RS-232C port on NJ-CPU-B16, select [RS-232C]. In other cases, select [RS-485].
Baud Rate	<u>19200</u> bps	
Data Length	<u>8</u> bits	
Stop Bit	<u>1</u> bit	
Parity	<u>Odd</u>	
Target Port No.	<u>0</u>	

PLC

SPB, FLEX-PC CPU Port

No particular setting is necessary on the PLC.

Built-in RS-232C Port on NJ-CPU-B16

On the PLC loader, set parameters for the built-in RS-232C port.

Be sure to match the settings to those made on the [Communication Setting] tab window of the editor.

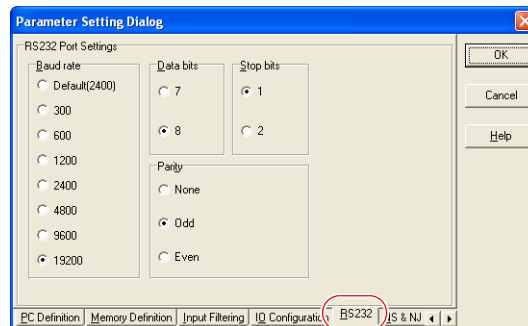

Available Memory

The available memory is the same as the one described in "15.1.2 SPB (N Mode) & FLEX-PC Series".

15.1.4 MICREX-SX SPH/SPB Series (IEC Mode)

Communication Setting

Editor

Communication setting

(Underlined setting: default)

Item	Setting	Remarks
Connection Mode	<u>1:1</u> / Multi-link2	
Signal Level	<u>RS-232C</u> / RS-422/485	
Baud Rate	38400 bps	For the SPH series: Do not change the default setting.
Data Length	8 bits	
Stop Bit	1 bits	
Parity	Even	
Target Port No.	<u>Q</u> to 31	

PLC

NP1L-RS1, NP1L-RS2, NP1L-RS3, NP1L-RS4, NP1L-RS5

Mode setting

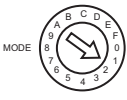
MODE	Setting	RS1, 2, 4	RS-232C Port	RS-485 Port	Remarks
		RS3, 5	CH1	CH2	
	0		General equipment	General equipment	
	1		Loader	General equipment	
	2		General equipment	Loader	
	3		Loader	Loader	
	4		General equipment	General equipment	RS3 and 5 are not used.
	5		Not used		
	6		Modem loader 19200 bps	General equipment	
	7		Self-diagnosis mode 1		
	8		Self-diagnosis mode 2		
	9		Modem loader 19200 bps	Loader	
	A		Modem loader 9600 bps	General equipment	
	B		Modem loader 9600 bps	Loader	
	C		Modem loader 38400 bps	General equipment	
	D		Modem loader 38400 bps	Loader	
	E		Modem loader 76800 bps	General equipment	
	F		Modem loader 115200 bps	Modem loader 115200 bps	

* Set the port (or CH No.) where the TS is connected to "loader".
Communication parameters are fixed to 38400 bps (baud rate), 8 bits (data length), 1 bit (stop bit), and even (parity).

* When the PLC is connected with the TS, the station number setting switch for RS-485 is not used.

NW0LA-RS2, NW0LA-RS4 (Parameter Setting)

On the PLC loader, set parameters for general communications.
Be sure to match the settings to those made on the [Communication Setting] tab window of the editor.

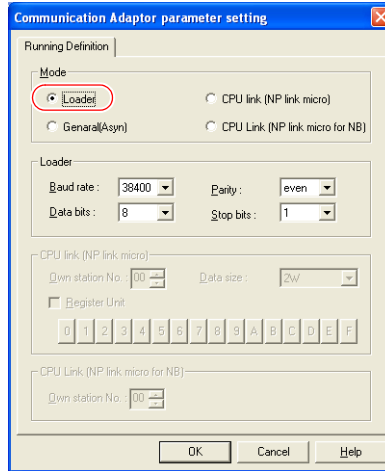

Item	Setting	Remarks
Mode	Loader	
Baud rate	4800 / 9600 / 19200 / 38400	
Parity	Odd / Even / None	
Data bits	8	
Stop bits	1 / 2	

Available Memory

Variable name cooperation function
The variable name cooperation function can be used only for PLC1. For memory assignment, basically use the variable name cooperation function. **It is recommended that you specify a memory address in the [AT] field to define the area (variable) that is used for communications with the TS.**

The available memory setting range varies depending on the PLC model. Be sure to set within the range available for the PLC. Use [TYPE] when assigning the indirect memory for macro programs.

Memory	TYPE	Remarks
%IX (input memory) *1	-	%IW as word device, %ID as double-word device *3
%QX (output memory) *1	-	%QW as word device, %QD as double-word device *3
%MX1. (standard memory)	02H	%MW1. as word device, %MD1. as double-word device *2 *3
%MX3. (retain memory)	04H	%MW3. as word device, %MD3. as double-word device *2 *3
%MX10. (system memory)	08H	%MW10. as word device, %MD10. as double-word device *2 *3

- *1 For the input/output memory, the variable name cooperation function of the PLC1 must be used. Indirect designation is not available with the input/output memory.
- *2 Double-word addresses (%MD1., %MD3., %MD10.) can be specified only for PLC1. In the case with PLC2 to PLC8, access to the above addresses is possible when the data length is set to 2 words in the word address (%MW1., %MW3., %MW10.).
Example: When accessing the address in %MD1.100:
Set the data length to 2 words for %MW1.100.
- *3 The assigned memory is indicated when editing the screen as shown below.
 - For %IX or %QX:

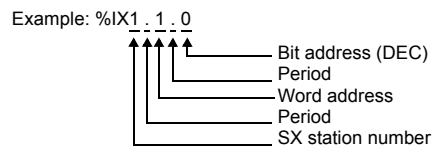
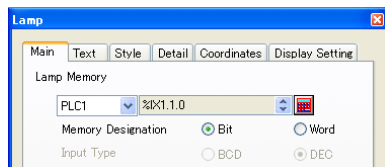

- For %MX1., %MX3., or %MX10:

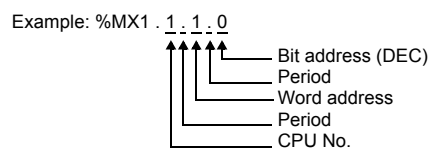
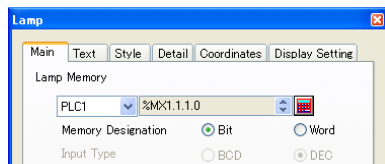

Indirect Memory Designation

Specify the CPU number in the expansion code.

PLC_CTL

Macro command "PLC_CTL F0 F1 F2"

Contents	F0	F1 (= \$u n)		F2
All start	1 - 8 (PLC1 - 8)	n	Station number: 0000H	2
		n + 1	Command: 0400H	
All stop	1 - 8 (PLC1 - 8)	n	Station number: 0000H	2
		n + 1	Command: 0402H	
Operation / standby switching *	1 - 8 (PLC1 - 8)	n	Station number: 0000H	3
		n + 1	Command: 040BH	
		n + 2	CPU No. operated by default: m (0, 2, 4, 6)	

* Valid only for the redundant system.

15.1.5 MICREX-SX SPH/SPB Series (N Mode / F Mode)

Communication Setting

The communication setting is the same as the one described in "15.1.4 MICREX-SX SPH/SPB Series (IEC Mode)".

Available Memory

The available memory setting range varies depending on the PLC model. Be sure to set within the range available with the PLC to be used. Use [TYPE] when assigning the indirect memory for macro programs.

Memory	TYPE	Remarks
X (input memory) *1	-	WX as word device, DX as double-word device *3
Y (output memory) *1	-	WY as word device, DY as double-word device *3
M (standard memory)	02H	WM as word device, DM as double-word device *2 *3
L (retain memory)	04H	WL as word device, DL as double-word device *2 *3
SM (system memory)	08H	WSM as word device, DSM as double-word device *2 *3

*1 Input/output memory does not operate normally unless you import the ".ini" file created using [Export Device Information] in the PLC programming tool. Indirect designation is not available with the input/output memory.

*2 Double-word addresses (DM, DL, DSM) can be specified only for PLC1. In the case with PLC2 to PLC8, access to the above addresses is possible when the data length is set to 2 words in the word address (WM, WL, WSM).

Example: When accessing the address in DM100:
Set the data length to 2 words for WM100.

*3 The assigned memory is indicated when editing the screen as shown on the right.

- For X or Y:

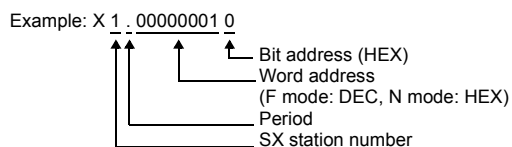
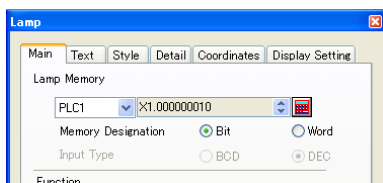

- For M, L or SM

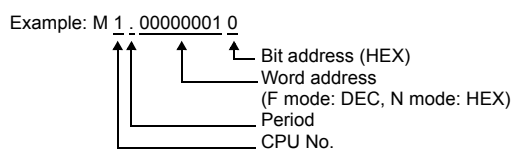
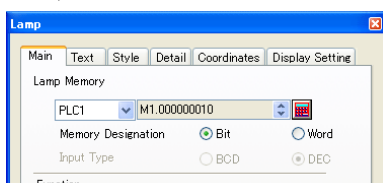

Indirect Memory Designation

Specify the CPU number in the expansion code.

PLC_CTL

The macro command is the same as the one described in “15.1.4 MICREX-SX SPH/SPB Series (IEC Mode)”.

15.1.6 MICREX-SX SPH/SPB CPU (IEC Mode)

Communication Setting

Editor

Communication setting

(Underlined setting: default)

Item	Setting	Remarks
Connection Mode	<u>1 : 1</u> / Multi-link2	
Signal Level	RS-422/485	Do not change the setting from default.
Baud Rate	38400 bps	
Data Length	8 bits	
Stop Bit	1 bit	
Parity	Even	
Target Port No.	<u>0</u> to 31	

PLC

No particular setting is necessary on the PLC.

Communication parameters are fixed to 38400 bps (baud rate), RS-422 (signal level), 8 bits (data length), 1 bit (stop bit), and even (parity).

Available Memory

The available memory is the same as the one described in “15.1.4 MICREX-SX SPH/SPB Series (IEC Mode)”.

PLC_CTL

The macro command is the same as the one described in “15.1.4 MICREX-SX SPH/SPB Series (IEC Mode)”.

15.1.7 MICREX-SX SPH/SPB CPU (N Mode / F Mode)

Communication Setting

The communication setting is the same as the one described in “15.1.6 MICREX-SX SPH/SPB CPU (IEC Mode)”.

Available Memory

The available memory is the same as the one described in “15.1.5 MICREX-SX SPH/SPB Series (N Mode / F Mode)”.

PLC_CTL

The macro command is the same as the one described in “15.1.4 MICREX-SX SPH/SPB Series (IEC Mode)”.

15.1.8 MICREX-SX (Ethernet)

Communication Setting

Editor

Make the following settings on the editor. For more information, see “Appendix 2 Ethernet”.

- IP address for the TS unit
 - When specified on the screen data:
[System Setting] → [Ethernet Communication] → [Local Port IP Address]
 - When specified on the TS unit:
Main Menu screen → [Ethernet]
- TS unit's port number in the [Communication Setting] tab window ([System Setting] → [Device Connection Setting])
- PLC's IP address and port number for [PLC Table] in the [Target Settings] tab window ([System Setting] → [Device Connection Setting])
The PLC port number is “Self port standard No.” plus 251 set on the PLC.

PLC (Ethernet Parameter Setting)

The table below shows settings required for communication with the TS.

(Underlined setting: default)

Item	Setting	Remarks
IP Address	<u>192.168.0.1</u>	
Subnet Mask	<u>255.255.255.0</u>	
Self-port Standard No.	<u>256</u>	

For more information on other setting items, refer to the PLC manual issued by the manufacturer.

Setting Example

The following example shows the setting for communication between MICREX-SX ET1 module and the TS unit via Ethernet.

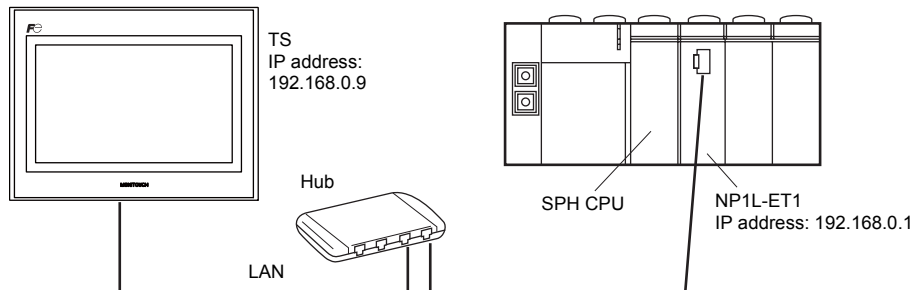

Setting on the PLC loader

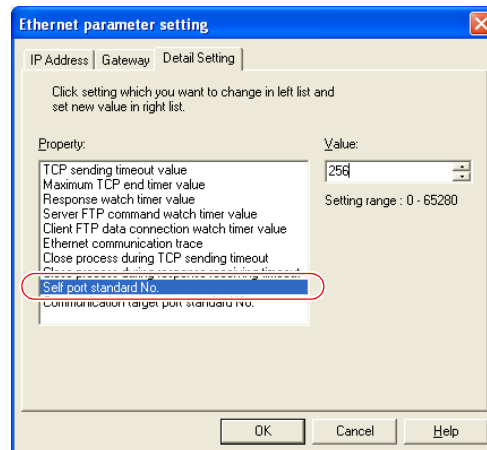
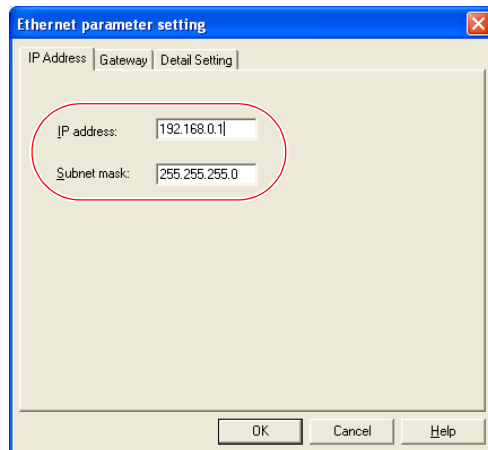

When the Ethernet module is used, the module driver must be transferred to the PLC.
To transfer it to the PLC, check [Module driver] on the relevant PLC transfer setting dialog.

- SX Programmer Standard Ver. 2

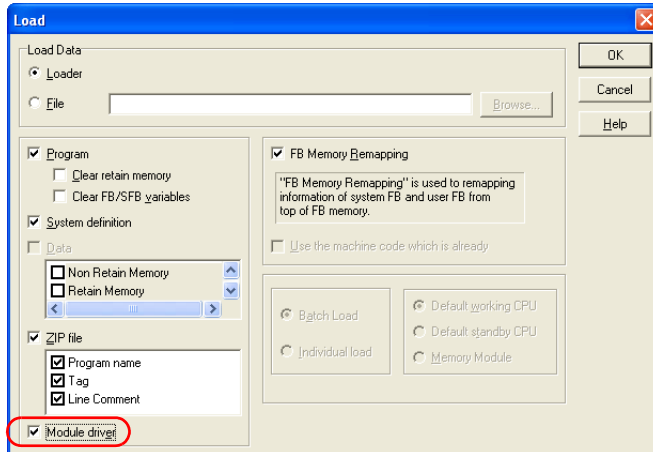

- SX Programmer Standard Ver. 3

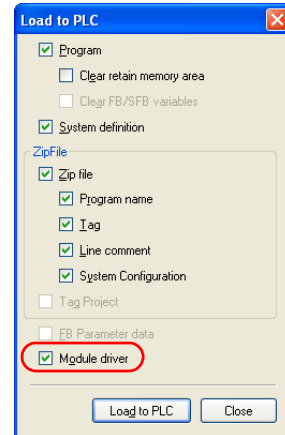

- D300win

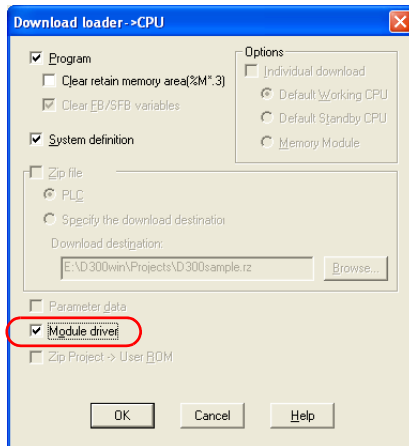

Setting on the editor

- IP address setting for the TS unit (on the editor)
[System Setting] → [Ethernet Communication] → [Local Port IP Address]

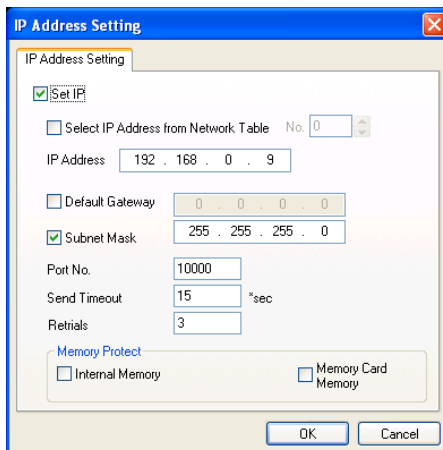

- PLC table
[System Setting] → [Device Connection Setting] → [Target Settings] → [PLC Table]

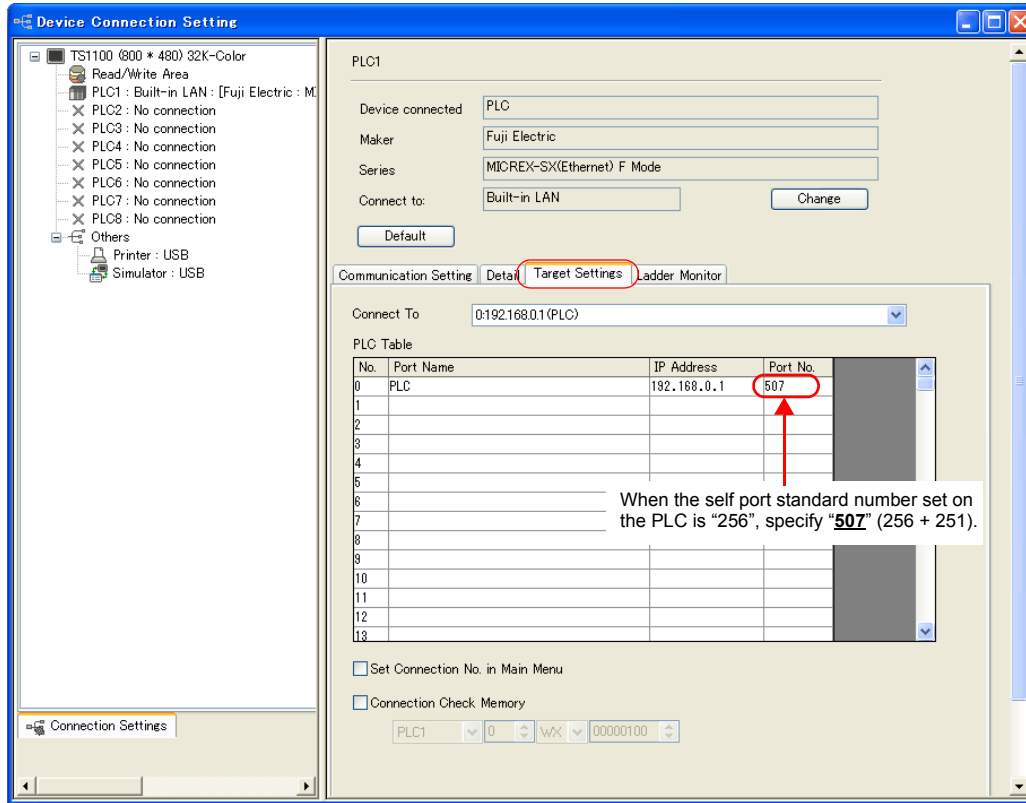

PLC_CTL

Macro command "PLC_CTL F0 F1 F2"

Contents	F0	F1 (= \$u n)		F2
All start	1 - 8 (PLC1 - 8)	n	Station number: 00H to FFH *1	2
		n + 1	Command: 0400H	
All stop	1 - 8 (PLC1 - 8)	n	Station number: 00H to FFH *1	2
		n + 1	Command: 0402H	
Operation / standby switching *2	1 - 8 (PLC1 - 8)	n	Station number: 00H to FFH *1	3
		n + 1	Command: 040BH	
		n + 2	CPU No. operated by default: m (0, 2, 4, 6)	

*1 Valid only when "1 : n" connection is selected in the [Communication Setting] tab window ([System Setting] → [Device Connection Setting]). For the station number, set the PLC table number specified for [PLC Table] in the [Target Settings] tab window ([System Setting] → [Device Connection Setting] → [Target Settings]).

*2 Valid only for the redundant system.

15.1.9 Wiring Diagrams

When Connected at COM1:

RS-422/RS-485

Wiring diagram 1 - COM1

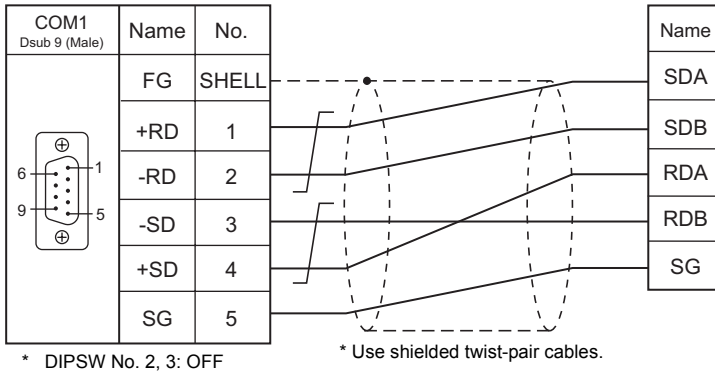

Wiring diagram 2 - COM1

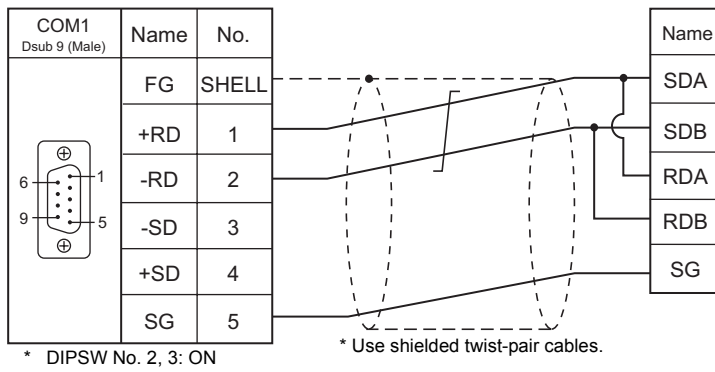

Wiring diagram 3 - COM1

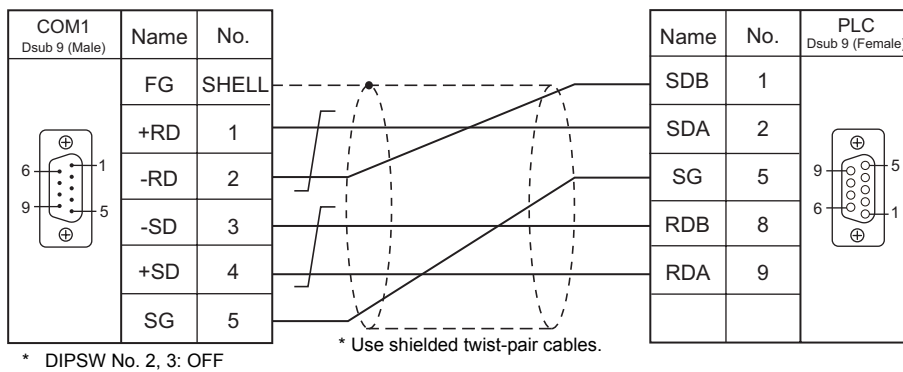

When Connected at COM2:

RS-232C

Wiring diagram 1 - COM2

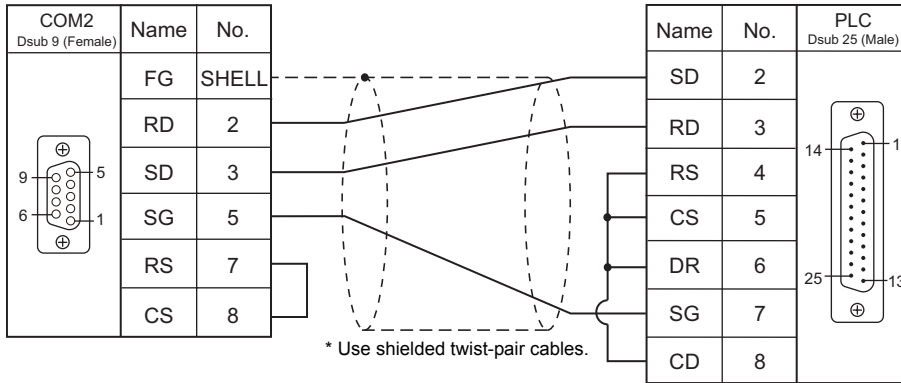

Wiring diagram 2 - COM2

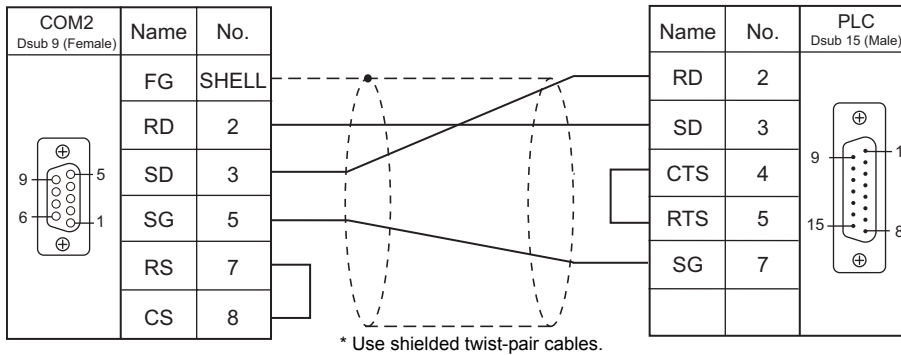

Wiring diagram 3 - COM2

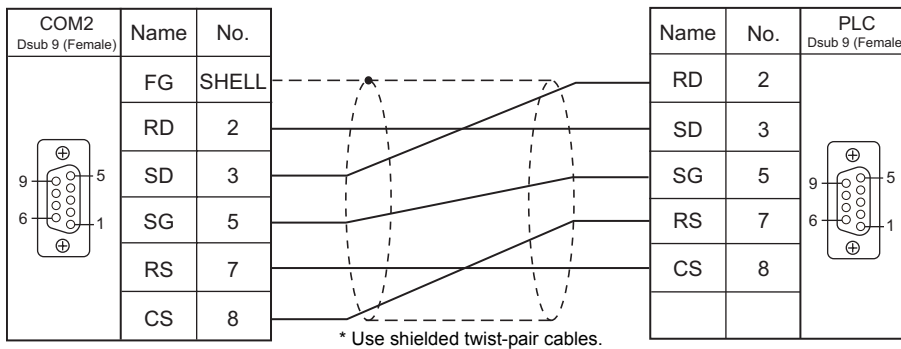

Wiring diagram 4 - COM2

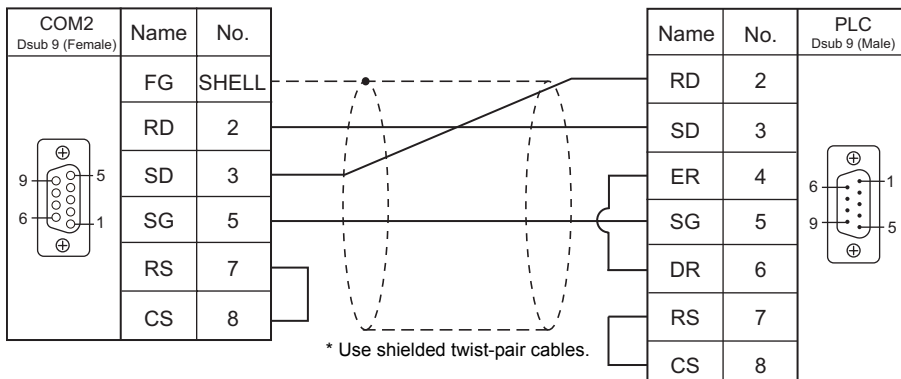

When Connected at COM3:

RS-485

Wiring diagram 1 - COM3

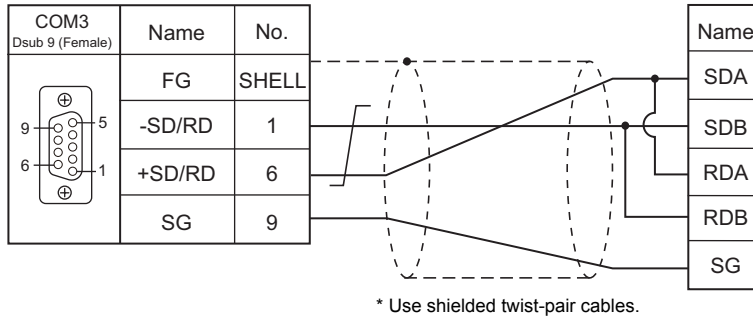

15.2 Temperature Controller/Servo/Inverter Connection

Temperature Controller

PLC Selection on the Editor	Model	Port	Signal Level	TS Port	Connection	Lst File
PYX (MODBUS RTU)	PYX4xx PYX5xx PYX9xx	*1 Terminal block	RS-485	COM1	Wiring diagram 1 - COM1	PYX.Lst
				COM3	Wiring diagram 1 - COM3	
PXR (MODBUS RTU)	PXR3xx PXR4xx PXR5xx PXR7xx PXR9xx	*1 Terminal block	RS-485	COM1	Wiring diagram 1 - COM1	PXR.Lst
				COM3	Wiring diagram 1 - COM3	
PXG (MODBUS RTU)	PXG4xx PXG5xx PXG9xx	*1 Terminal block	RS-485	COM1	Wiring diagram 1 - COM1	F_PXG.Lst
				COM3	Wiring diagram 1 - COM3	
PXH (MODBUS RTU)	PXH9xx	*1 Terminal block	RS-485	COM1	Wiring diagram 2 - COM1	F_PXH.Lst
				COM3	Wiring diagram 2 - COM3	
PUM (MODBUS RTU)	PUMxx	Terminal block (base)	RS-485	COM1	Wiring diagram 2 - COM1	F_PUMA_B.Lst F_PUME.Lst
				COM3	Wiring diagram 2 - COM3	

*1 Select a model on which Modbus communication is available.

Power Monitor Unit

PLC Selection on the Editor	Series Name	Model	Port	Signal Level	TS Port	Connection	Lst File
F-MPC04P (loader)	F-MPC04P	UM02-AR2 UM02-AR3 UM02-AR4	RS-485 connector	RS-485	COM1	Wiring diagram 3 - COM1	F-MPC04P.Lst
					COM3	Wiring diagram 3 - COM3	
F-MPC series / FePSU	F-MPC04	UM01-ARxx	Terminal block	RS-485	COM1	Wiring diagram 4 - COM1	UM01_ARA4.Lst
					COM3	Wiring diagram 4 - COM3	
	F-MPC04P	UM02-AR2 UM02-AR3 UM02-AR4	Terminal block	RS-485	COM1	Wiring diagram 4 - COM1	UM02_AR2.Lst
					COM3	Wiring diagram 4 - COM3	UM02_AR3.Lst
							UM02_AR4.Lst
	F-MPC04S	UM03-AR3x	Terminal block	RS-485	COM1	Wiring diagram 4 - COM1	UM03_ARA3G.Lst
					COM3	Wiring diagram 4 - COM3	
	F-MPC30	UM5ACxx UM45xx	*1 Terminal block	RS-485	COM1	Wiring diagram 4 - COM1	UM5A.Lst
					COM3	Wiring diagram 4 - COM3	
	F-MPC50	UM50xx	*1 Terminal block	RS-485	COM1	Wiring diagram 4 - COM1	UM50.Lst
					COM3	Wiring diagram 4 - COM3	
	F-MPC55	UM55V	Terminal block	RS-485	COM1	Wiring diagram 4 - COM1	UM55V.Lst
					COM3	Wiring diagram 4 - COM3	
F-MPC60B	UM4Bxx UM42Cxx UM42Fxx UM43FDxx UM43FGxx	*1 Terminal block	RS-485	COM1	Wiring diagram 4 - COM1	UM4_UM42_UM43.Lst	
				COM3	Wiring diagram 4 - COM3	UM44.Lst	
FePSU	EAxx EGxx SAxx SGxx	Terminal block	RS-485	COM1	Wiring diagram 5 - COM1	FePSU.Lst	
				COM3	Wiring diagram 5 - COM3	FePSUBk.Lst	
	BWxxxxxx EWxxxxxx						

*1 Select a model on which RS-485 communication is available.

Inverter

PLC Selection on the Editor	Model	Port	Signal Level	TS Port	Connection	Lst File
FVR-E11S	FVRxxE11S-x	Touch panel connector	RS-485	COM1	Wiring diagram 6 - COM1	FVR-E11S.Lst
				COM3	Wiring diagram 6 - COM3	
FVR-E11S (MODBUS RTU)	FVRxxE11S-x	Touch panel connector	RS-485	COM1	Wiring diagram 6 - COM1	FVR-E11S(Modbus).Lst
				COM3	Wiring diagram 6 - COM3	
FVR-C11S (MODBUS RTU)	FVRxxC11S-x	OPC-C11S-RSx	RS-485	COM1	Wiring diagram 7 - COM1	FVR-C11S(Modbus).Lst
				COM3	Wiring diagram 7 - COM3	
FRENIC5000G11S / P11S	FRNxxG11S-x FRNxxP11S-x	Terminal block	RS-485	COM1	Wiring diagram 8 - COM1	F-G11S.Lst
				COM3	Wiring diagram 8 - COM3	
FRENIC5000G11S / P11S (MODBUS RTU)	FRNxxG11S-x FRNxxP11S-x	Terminal block	RS-485	COM1	Wiring diagram 8 - COM1	FRENIC5000G11S_P11S(Modbus).Lst
				COM3	Wiring diagram 8 - COM3	
FRENIC5000VG7 (MODBUS RTU)	FRNxxVG7S-x	RS-485 connector	RS-422	COM1	Wiring diagram 9 - COM1	FRENIC5000VG7S (Modbus).Lst
			RS-485	COM3	Wiring diagram 9 - COM3	
		OPC-VG7-RS (communication board)	RS-485	COM1	Wiring diagram 8 - COM1	
			COM3	Wiring diagram 8 - COM3		
FRENIC-Mini (MODBUS RTU)	FRNxxC1S-x	OPC-C1-RS (communication board)	RS-485	COM1	Wiring diagram 10 - COM1	F-Mini.Lst
				COM3	Wiring diagram 10 - COM3	
FRENIC-Eco (MODBUS RTU)	FRNxxF1S-x	Touch panel connector	RS-485	COM1	Wiring diagram 10 - COM1	F-Eco(Modbus).Lst
				COM3	Wiring diagram 10 - COM3	
		OPC-F1-RS (communication board)	RS-485	COM1	Wiring diagram 8 - COM1	
			COM3	Wiring diagram 8 - COM3		
FRENIC-Multi (MODBUS RTU)	FRNxxE1S-x	Touch panel connector	RS-485	COM1	Wiring diagram 10 - COM1	F-Multi.Lst
				COM3	Wiring diagram 10 - COM3	
		OPC-E1-RS (communication board)	RS-485	COM1	Wiring diagram 10 - COM1	
			COM3	Wiring diagram 10 - COM3		
FRENIC-MEGA (MODBUS RTU)	FRNxxxG1x-xx	Touch panel connector	RS-485	COM1	Wiring diagram 10 - COM1	FRENIC-MEGA (Modbus).Lst
				COM3	Wiring diagram 10 - COM3	
		Terminal block on control circuit	RS-485	COM1	Wiring diagram 8 - COM1	
			COM3	Wiring diagram 8 - COM3		
FRENIC-MEGA SERVO (MODBUS RTU)	FRNxxxG1x-xxxQ	Touch panel connector	RS-485	COM1	Wiring diagram 10 - COM1	FRENIC-MEGA SERVO(Modbus).Lst
				COM3	Wiring diagram 10 - COM3	
		Control circuit terminal block	RS-485	COM1	Wiring diagram 8 - COM1	
			COM3	Wiring diagram 8 - COM3		
FRENIC-HVAC/AQUA (MODBUS RTU)	FRNxxxAR1x-4x FRNxxxAQ1x-4x	Touch panel connector	RS-485	COM1	Wiring diagram 10 - COM1	FRENIC-HVAC (Modbus).Lst FRENIC-AQUA (Modbus).Lst
				COM3	Wiring diagram 10 - COM3	
		Control circuit terminal block	RS-485	COM1	Wiring diagram 8 - COM1	
			COM3	Wiring diagram 8 - COM3		

IH Inverter

PLC Selection on the Editor	Model	Port	Signal Level	TS Port	Connection	Lst File
HFR-C9K	HFR030C9Kxx HFR050C9Kxx	HFR-OPC01 (communication board)	RS-485	COM1	Wiring diagram 13 - COM1	F_HFR.Lst
				COM3	Wiring diagram 13 - COM3	
HFR-C11K	HFR3.0C11Kxx HFR5.0C11Kxx HFR7.0C11Kxx	Terminal block	RS-485	COM1	Wiring diagram 8 - COM1	HFR-C11K.Lst
				COM3	Wiring diagram 8 - COM3	

AC Power Monitor

PLC Selection on the Editor	Model	Port	Signal Level	TS Port	Connection	Lst File
PPMC (MODBUS RTU)	PPMCxx *1	Terminal block	RS-232C	COM2	Wiring diagram 1 - COM2	F-PPMC.Lst
			RS-485	COM1	Wiring diagram 1 - COM1	
				COM3	Wiring diagram 1 - COM3	

*1 Select a model on which RS-485 or RS-232C communication is available.

Servo Amplifier

PLC Selection on the Editor	Model	Port	Signal Level	TS Port	Connection	Lst File
FALDIC- α series	RYSxx *1	CN3	RS-422	COM1	Wiring diagram 12 - COM1	F_FAL-A.Lst
			RS-485	COM3	Wiring diagram 12 - COM3	
FALDIC-W series	RYCxxx x3-VVT2	CN3A (UP port)	RS-422	COM1	Wiring diagram 17 - COM1	F_Fal-W.Lst
			RS-485	COM3	Wiring diagram 17 - COM3	
ALPHA5 (MODBUS RTU)	RYTxxxx5- VVx	CN3A	RS-485	COM1	Wiring diagram 14 - COM1	ALPHA5.Lst
				COM3	Wiring diagram 14 - COM3	
ALPHA5 Smart (MODBUS RTU)	RYHxxxF5 -VV2	CN3A	RS-485	COM1	Wiring diagram 14 - COM1	ALPHA5Smart.Lst
				COM3	Wiring diagram 14 - COM3	

*1 Select a model on which host interface: universal communication (RS-485) is available.

Controller

PLC Selection on the Editor	Model	Port	Signal Level	TS Port	Connection	Lst File	
WSZ series	WSZ-24MCT2-AC WSZ-32MCT2-AC WSZ-40MCT2-AC WSZ-60MCT2-AC	PORT0	RS-232C	COM2	Wiring diagram 3 - COM2	WSZ.Lst	
		WSZ-CB25	PORT1	RS-232C	COM2		Wiring diagram 4 - COM2
			PORT2	RS-485	COM1		Wiring diagram 18 - COM1
					COM3		Wiring diagram 18 - COM3

Recorder

PLC Selection on the Editor	Model	Port	Signal Level	TS Port	Connection	Lst File
PH series	PHAxxxx4-xxxRY PHCxxxx3-xxxRY	Terminal block	RS-485	COM1	Wiring diagram 16 - COM1	F_PHC.Lst
				COM3	Wiring diagram 16 - COM3	
PHR (MODBUS RTU)	PHRxx	Terminal block	RS-485	COM1	Wiring diagram 2 - COM1	F_PHR.Lst
				COM3	Wiring diagram 2 - COM3	

Digital Panel Meter

PLC Selection on the Editor	Model	Port	Signal Level	TS Port	Connection	Lst File
WA5000	WA5xx3-yy WA5xx4-yy *1 WA5xx6-yy WA5xx7-yy	Modular Jack	RS-232C	COM2	Wiring diagram 2 - COM2	WA5000.Lst
			RS-485	COM1	Wiring diagram 11 - COM1	
				COM3	Wiring diagram 11 - COM3	

*1 Specify an input unit (-yy: 01 to 12, or 18) when selecting the model.

AC Power Regulator

PLC Selection on the Editor	Model	Port	Signal Level	TS Port	Connection	Lst File
APR-N (MODBUS RTU)	RPNExxxx-xx- ZAM-xx/xx	RPN003-AM (communication board)	RS-485	COM1	Wiring diagram 4 - COM1	F_APR-N.Lst
				COM3	Wiring diagram 4 - COM3	

Electronic Multimeter

PLC Selection on the Editor	Model	Port	Signal Level	TS Port	Connection	Lst File
WE1MA (Ver. A) (MODBUS RTU)	WE1MA-AFxxx-Mxx	Terminal block	RS-485	COM1	Wiring diagram 15 - COM1	F_WE1MA.Lst
	WE1MA-AGxxx-Mxx					F_WE1MA_1P.Lst *1
	WE1MA-A1xxx-Mxx					F_WE1MA_1P3L.Lst *1
	WE1MA-A5xxx-Mxx					F_WE1MA_3P3L.Lst *1
	WE1MA-A2xxx-Mxx			COM3	Wiring diagram 15 - COM3	F_WE1MA_3P4L.Lst *1
	WE1MA-A6xxx-Mxx					
	WE1MA-A3xxx-Mxx					
WE1MA-A7xxx-Mxx						
WE1MA-A4xxx-Mxx						
WE1MA (Ver. B) (MODBUS RTU)	WE1MA-AFxxx-Mxx	Terminal block	RS-485	COM1	Wiring diagram 15 - COM1	F_WE1MA (Ver. B).Lst
	WE1MA-AGxxx-Mxx					F_WE1MA_1P (Ver. B).Lst *1
	WE1MA-A1xxx-Mxx					F_WE1MA_1P3L (Ver. B).Lst *1
	WE1MA-A5xxx-Mxx					F_WE1MA_3P3L (Ver. B).Lst *1
	WE1MA-A2xxx-Mxx			COM3	Wiring diagram 15 - COM3	F_WE1MA_3P4L (Ver. B).Lst *1
	WE1MA-A6xxx-Mxx					
	WE1MA-A3xxx-Mxx					
WE1MA-A7xxx-Mxx						
WE1MA-A4xxx-Mxx						

*1 List files "F_WE1MA.Lst" and "F_WE1MA(Ver. B).Lst" can be browsed as default through the [Refer] button. These files can be used for memory settings.

15.2.1 PYX (MODBUS RTU)

Communication Setting

Editor

Communication setting

(Underlined setting: default)

Item	Setting	Remarks
Connection Mode	1 : 1 / <u>1:n</u> / Multi-link2	
Signal Level	RS-422/485	Do not change the default settings because these settings on the temperature controller cannot be changed.
Baud Rate	9600 bps	
Data Length	8 bits	
Stop Bit	1 bit	
Parity	Odd	
Target Port No.	1 to 31	

Temperature Controller

The communication parameter can be set using keys attached to the front of the temperature controller.

Be sure to match the settings to those made on the [Communication Setting] tab window of the editor.

(Underlined setting: default)

Parameter	Item	Setting	Example
	Digital transmission function (station number)	<u>1</u> to 31	1

* The communication function of the temperature controller can be selected from Fuji protocol or Modbus protocol at the time of purchase. For communication with a TS, select a model on which the Modbus protocol is available.

* The following communication parameters are fixed; baud rate: 9600 bps, data length: 8 bits, stop bit: 1 bit, and parity: odd.

Available Memory

The available memory setting range varies depending on the device. Be sure to set within the range available with the device to be used. Use [TYPE] when assigning the indirect memory for macro programs.

Memory	TYPE	Remarks
0	00H	
1	01H	Read only
4	02H	
3	03H	Read only

15.2.2 PXR (MODBUS RTU)

Communication Setting

Editor

Communication setting

(Underlined setting: default)

Item	Setting	Remarks
Connection Mode	1 : 1 / <u>1:n</u> / Multi-link2	
Signal Level	RS-422/485	Do not change the default settings because these settings on the temperature controller cannot be changed.
Baud Rate	9600 bps	
Data Length	8 bits	
Stop Bit	1 bit	
Parity	None / Even / <u>Odd</u>	
Target Port No.	1 to 31	

Temperature Controller

The communication parameter can be set using keys attached to the front of the temperature controller.

Be sure to match the settings to those made on the [Communication Setting] tab window of the editor.

(Underlined setting: default)

Parameter	Display	Item	Setting	Example	
Third block parameter	Sfno	STno	Station number	<u>1</u> - 31	1
	CoM	CoM	Parity	<u>0</u> : Odd 1: Even 2: None	0
	PCoL	PCoL	Communication protocol	1: Modbus ^{*1} 2: Z-ASCII	1

*1 The communication function of the temperature controller can be selected at the time of purchase. Select a model on which RS-485 (Modbus) communication is available.

*2 The following communication parameters are fixed; baud rate: 9600 bps, data length: 8 bits, and stop bit: 1 bit.

Available Memory

The available memory setting range varies depending on the device. Be sure to set within the range available with the device to be used. Use [TYPE] when assigning the indirect memory for macro programs.

Memory	TYPE	Remarks
0	00H	
1	01H	Read only
4	02H	
3	03H	Read only

15.2.3 PXG (MODBUS RTU)

Communication Setting

Editor

Communication setting

(Underlined setting: default)

Item	Setting	Remarks
Connection Mode	1 : 1 / <u>1:n</u> / Multi-link2	
Signal Level	RS-422/485	Do not change the default settings of the signal level, data length and stop bit because these settings on the temperature controller cannot be changed.
Baud Rate	<u>9600</u> / 19200 bps	
Data Length	8 bits	
Stop Bit	1 bit	
Parity	None / Even / <u>Odd</u>	
Target Port No.	1 to 31	

Temperature Controller

The communication parameter can be set using keys attached to the front of the temperature controller.

Be sure to match the settings to those made on the [Communication Setting] tab window of the editor.

(Underlined setting: default)

Channel	Parameter Display	Item	Setting	Example	
"CoM Ch9" Communication (Ch9)	"STno"	STno	Station number	<u>1</u> to 31	1
	"CoM"	CoM	Parity	<u>96od</u> (9600 bps / odd parity) 96Ev (9600 bps / even parity) 96no (9600 bps / without parity) 19od (19200 bps / odd parity) 19Ev (19200 bps / even parity) 196no (19200 bps / without parity)	96od
	"SCC"	SCC	Communication authority	r (Read only) <u>rW</u> (Read/write allowed)	rW

* The communication function of the temperature controller can be selected at the time of purchase. Select a model on which RS-485 (Modbus) communication is available.

* The following communication parameters are fixed; data length: 8 bits and stop bit: 1 bit.

Available Memory

The available memory setting range varies depending on the device. Be sure to set within the range available with the device to be used. Use [TYPE] when assigning the indirect memory for macro programs.

Memory	TYPE	Remarks
1 (input relay)	01H	
4 (holding register)	02H	
3 (input register)	03H	

15.2.4 PXH (MODBUS RTU)

Communication Setting

Editor

Communication setting

(Underlined setting: default)





Item	Setting	Remarks
Connection Mode	1 : 1 / <u>1:n</u> / Multi-link2	
Signal Level	RS-422/485	
Baud Rate	9600 / 19200 / <u>38400</u> bps	Do not change the default settings of the signal level, data length and stop bit because these settings on the temperature controller cannot be changed.
Data Length	8 bits	
Stop Bit	1 bit	
Parity	None / Even / <u>Odd</u>	
Target Port No.	1 to 31	

Temperature Controller

The communication parameter can be set using keys attached to the front of the temperature controller.

Be sure to match the settings to those made on the [Communication Setting] tab window of the editor.

(Underlined setting: default)

Channel	Parameter Display	Item	Setting	Example
 Communication (Ch B)	 STn4	RS-485 station No.	<u>1</u> to 31	1
	 SPd4	RS-485 baud rate	96: 9600 bps 192: 19200 bps <u>384: 38400 bps</u>	384
	 biT4	RS-485 bit format	8n: Data length 8 bits, without parity <u>8o: Data length 8 bits, odd parity</u> 8E: Data length 8 bits, even parity	8o

* The communication function of the temperature controller can be selected at the time of purchase. Select a model on which RS-485 (Modbus) communication is available.

* The following communication parameters are fixed; data length: 8 bits and stop bit: 1 bit.

Available Memory

The available memory setting range varies depending on the device. Be sure to set within the range available with the device to be used. Use [TYPE] when assigning the indirect memory for macro programs.

Memory	TYPE	Remarks
4 (holding register)	02H	
3 (input register)	03H	

15.2.5 PUM (MODBUS RTU)

Communication Setting

Editor

Communication setting

(Underlined setting: default)

Item	Setting	Remarks
Connection Mode	1 : 1 / <u>1:n</u> / Multi-link2	
Signal Level	RS-422/485	Do not change the default settings of the signal level, data length and stop bit because these settings on the temperature controller cannot be changed.
Baud Rate	9600 / <u>19200</u> / 38400 / 115200 bps	
Data Length	8 bits	
Stop Bit	1 bit	
Parity	<u>None</u> / Even / Odd	
Target Port No.	1 to 15 [DEC]	

Temperature Controller

Be sure to match the settings to those made on the [Communication Setting] tab window of the editor.

Station number setting

(Underlined setting: default)

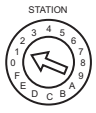
STATION	Setting	Example
	<u>0</u> to F [HEX]	0: Station number 1 F: Station number 16

Communication setting

On the temperature controller loader, set communication parameters.

(Underlined setting: default)

Item	Setting	Example	Remarks
RS-485 parity setting	0: <u>None</u> 1: Odd 2: Even	0	
RS-485 baud rate setting	0: 9600 1: <u>19200</u> 2: 38400 4: 115200 kbps	1	
RS-485 communication authority setting	0: Read only 1: <u>Read/write allowed</u>	1	
RS-485 response interval setting	0 to 25 (default: <u>1</u>)	1	Response interval = setting value × 20 ms
Extensional communication module (PUMC) connection	0: <u>Without PUMC (RS-485 valid)</u> 1: With PUMC (RS-485 invalid)	0	When using RS-485 communication, set "0".

* The following communication parameters are fixed; data length: 8 bits and stop bit: 1 bit.

Available Memory

The available memory setting range varies depending on the device. Be sure to set within the range available with the device to be used. Use [TYPE] when assigning the indirect memory for macro programs.

Memory	TYPE	Remarks
4 (holding register)	02H	
3 (input register)	03H	

Note on Setting the Memory

In accordance with the connected PUM model, set the "List" file name to be browsed by pressing the [Refer] button.

Model		List File Name
PUMAx	Control module (4 ch)	F_PUMA_B.Lst
PUMBx	Control module (2 ch)	
PUMEx	Event input/output module	F_PUME.Lst

"F_PUMA_B.Lst" is set as default.

15.2.6 F-MPC04P (Loader)

Communication Setting

Editor

Communication setting

(Underlined setting: default)

Item	Setting	Remarks
Connection Mode	1 : 1 / <u>1:n</u> / Multi-link2	
Signal Level	RS-422/485	
Baud Rate	4800 / 9600 / <u>19200</u> bps	
Data Length	<u>7</u> / 8 bits	
Stop Bit	1 bit	Do not change the default setting because the setting on the power monitor unit cannot be changed.
Parity	None / <u>Odd</u> / Even	
Target Port No.	1 to 99 ^{*1}	

*1 To use port No. 32 to 99, use the station number table.

Power Monitor Unit

Be sure to match the settings to those made on the [Communication Setting] tab window of the editor.

Station number setting

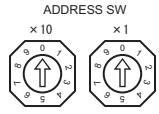
Station	Setting	Example	Remarks
	01 to 99 [DEC] (default: <u>0</u>)	1	

Communication setting

The communication parameter can be set using keys attached to the front of the power monitor unit.

(Underlined setting: default)

Circuit No.	Setting Code	Item	Setting	Example
C	L1-□□	Baud rate	00: 4800 bps 01: 9600 bps <u>02: 19200 bps</u>	02
	L2-□□	Parity	00: None 01: Even <u>02: Odd</u>	02
	L3-□□	Data length	<u>00: 7 bits</u> 01: 8 bits	00

* The communication parameter (stop bit) is fixed to 1 bit.

Available Memory

The available memory setting range varies depending on the device. Be sure to set within the range available with the device to be used. Use [TYPE] when assigning the indirect memory for macro programs.

Memory	TYPE	Remarks
---	00H	Double-word

Station Number Table

- A maximum of 31 units can be connected via serial communication. Port numbers from 0 to 31 can be set on the [Memory Setting] dialog of the editor; however, depending on the controller, port numbers exceeding 32 may be available. In such a case, use the station number table to enable communications with devices of port No. 32 or greater.
- It is easier to specify port numbers for each network in the field by making the screen for setting the port number when creating screen data. In this case, it is not necessary to transfer screen data again.

Setting the Station Number Table

1. Click [System Setting] → [Device Connection Setting]. On the [Communication Setting] tab window, check Use Port No. Table.

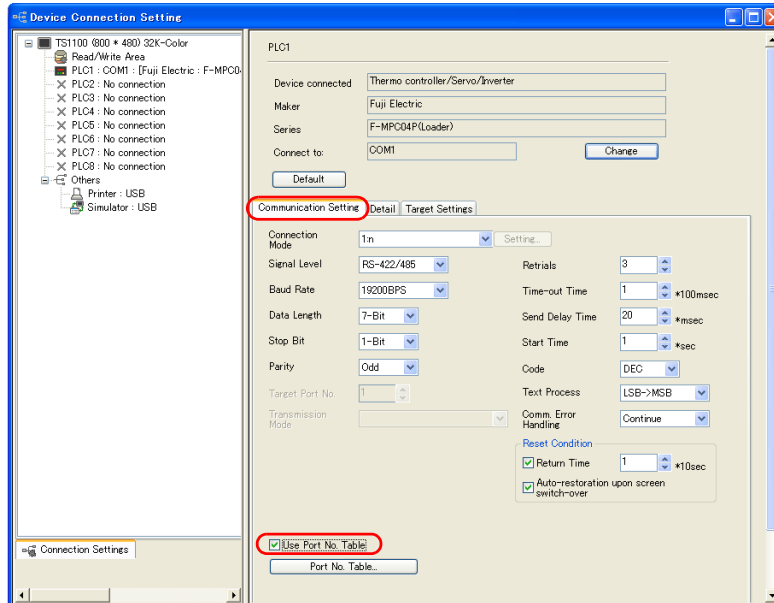

2. Click the [Port No. Table] button. The [Port No. Table Setting] dialog is displayed.
3. Specify port numbers of the temperature controllers for "Table 0" to "31".

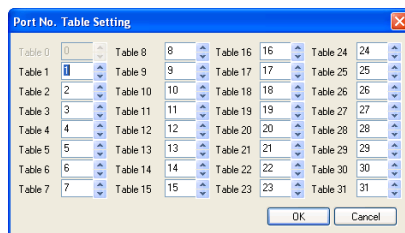

Macro

To rewrite the station number table on the TS series screen, use macro commands [FROM_WR] and [RESTART].

FROM_WR

FROM_WR F0 F1

- Function: Writing to FROM
As many words as specified for F1 from the memory address set for F0 is written in the FP-ROM.
- Available memory

	Internal Memory	PLC n Memory	Memory Card	Constant
F0	⊙	⊙	⊙	
F1				○

○: Setting enabled (indirect designation disabled)
⊙: Setting enabled (indirect designation enabled)

- Data range

	Setting	Remarks
F0	Top memory address of the source	32 words from the specified top memory address are used. Set port numbers from 0 to 31 for the memory addresses. For the station number table not used, set [-1].
F1	Number of transmission words: 32	If any other value than "32" is set, the write error (\$s728 = 1) occurs.

- Notes
 - The maximum possible number of write operations to the FP-ROM is 100,000 times. This is not related to the number of words that are written.
 - Do not include the FROM_WR command in a cycle macro or an event timer macro.
 - Writing to FP-ROM takes a longer time.
 - When the station number table has been rewritten using the [FROM_WR] command, be sure to execute the [RESTART] command.
 - When the station number table is used, it is not possible to set Use Internal Flash ROM as Back-up Area on the [General Settings] tab window that is displayed by selecting [System Setting] → [Unit Setting] → [General Settings]. Be sure to leave this box unchecked.

RESTART

When the station number table has been rewritten using the [FROM_WR] command, be sure to execute this command.

SYS (RESTART) F0

- Function: Reconnection
This macro command reconnects the controller when the time specified for F1 has elapsed.
- Available memory

	Internal Memory	PLC n Memory	Memory Card	Constant
F1	⊙			

○: Setting enabled (indirect designation disabled)
⊙: Setting enabled (indirect designation enabled)

- Data range

	Setting
F0	RESTART
F1	Time: 0 to 60 s

Example of Procedure for Rewriting the Station Number Table

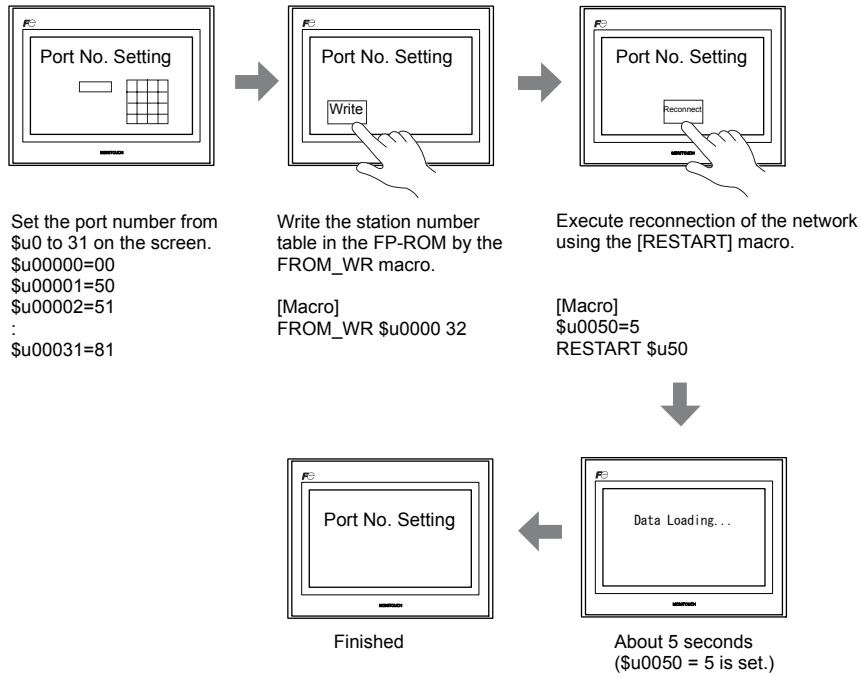

System Memory

The result of [FROM_WR] macro execution is stored in \$s728.
 [0]: Normal
 [1]: Error

15.2.7 F-MPC Series / FePSU

Communication Setting

Editor

Communication setting

(Underlined setting: default)

Item	Setting	Remarks
Connection Mode	1 : 1 / <u>1:n</u> / Multi-link2	
Signal Level	<u>RS-422/485</u>	
Baud Rate	4800 / 9600 / <u>19200</u> bps	
Data Length	<u>7</u> / 8 bits	
Stop Bit	1 bit	Do not change the default setting because the setting on the power monitor unit cannot be changed.
Parity	None / <u>Odd</u> / Even	
Target Port No.	1 to 99 ^{*1}	

*1 To use port numbers 32 to 99, use the station number table. For the station number table, see "Station Number Table" (page 15-31).

F-MPC04

Communication setting

The communication parameters can be set using keys attached to the front of the power monitor unit. Be sure to match the settings to those made on the [Communication Setting] tab window of the editor.

(Underlined setting: default)

Circuit No.	Setting Code	Item	Setting	Example
C	4-0	RS-485 address	<u>Loc: Communication not used</u> 01 to 99	01
	4-1	RS-485 baud rate setting	4.8: 4800 bps 9.6: 9600 bps <u>19.2: 19200 bps</u>	19.2
	4-2	RS-485 data length	<u>7: 7 bits</u> 8: 8 bits	7
	4-3	RS-485 parity	00: None 01: Even <u>02: Odd</u>	02

F-MPC04P

Be sure to match the settings to those made on the [Communication Setting] tab window of the editor.

Station number setting

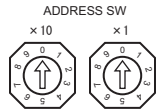
Station	Setting	Example	Remarks
	01 to 99 [DEC] (default: <u>0</u>)	1	

Communication setting

The communication parameters can be set using keys attached to the front of the power monitor unit.

(Underlined setting: default)

Circuit No.	Setting Code	Item	Setting	Example
C	L1-□□	Baud rate	00: 4800 bps 01: 9600 bps <u>02: 19200 bps</u>	02
	L2-□□	Parity	00: None 01: Even <u>02: Odd</u>	02
	L3-□□	Data length	<u>00: 7 bits</u> 01: 8 bits	00

* The communication parameter (stop bit) is fixed to 1 bit.

F-MPC04S

Communication setting

The communication parameters can be set using keys attached to the front of the power monitor unit. Be sure to match the settings to those made on the [Communication Setting] tab window of the editor.

(Underlined setting: default)

Setting Code	Item	Setting	Example
L-□□	Baud rate	4.8: 4800 bps 9.6: 9600 bps <u>19.2: 19200 bps</u>	19.2
L2-□□	Data length and parity	8n: Data length 8 bits, without parity 8E: Data length 8 bits, even parity 8o: Data length 8 bits, odd parity 7n: Data length 7 bits, without parity 7E: Data length 7 bits, even parity <u>7o: Data length 7 bits, odd parity</u>	7o
LA-□□	Address (Transmission station number)	<u>Loc: Station number not set</u> 01 to 99	01
Lt-□□	Communication model mode	<u>04: F-MPC04 mode</u> *1 PP: PPM (B) mode	04

*1 The communication function of F-MPC04 can be selected at the time of purchase. Select a model on which "F-MPC04 mode" is available.

*2 The communication parameter (stop bit) is fixed to 1 bit.

F-MPC30

Communication setting

The communication parameters can be set using keys attached to the front of the power monitor unit. Be sure to match the settings to those made on the [Communication Setting] tab window of the editor.

(Underlined setting: default)

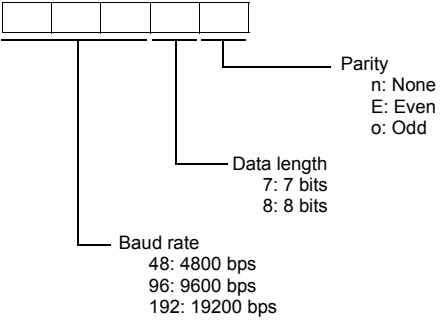
Setting Code	Item	Setting	Example
90	RS-485 address setting	<u>Loc: Communication not used</u> 01 to 99	01
91	RS-485 transmission specification	7SEG LED  <p>Parity n: None E: Even o: Odd</p> <p>Data length 7: 7 bits 8: 8 bits</p> <p>Baud rate 4.8: 4800 bps 9.6: 9600 bps 19.2: 19200 bps</p> <p>* "b<u>192E</u>" is set as default.</p>	1927o

* The communication parameter (stop bit) is fixed to 1 bit.

F-MPC50/F-MPC55/F-MPC60B (UM4Bx, UM42xx, UM43xx)

Communication setting

The communication parameters can be set using keys attached to the front of the power monitor unit. Be sure to match the settings to those made on the [Communication Setting] tab window of the editor.

(Underlined setting: default)

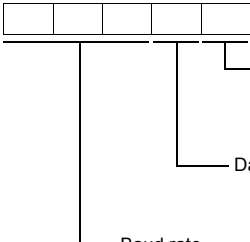
Setting Code	Item	Setting	Example
90	RS-485 address setting	<u>Loc: communication not used</u> 01 to 99	01
91	RS-485 transmission specification	7SEG LED  Parity n: None E: Even <u>o: Odd</u> Data length <u>7: 7 bits</u> 8: 8 bits Baud rate 48: 4800 bps 96: 9600 bps <u>192: 19200 bps</u>	1927o

* The communication parameter (stop bit) is fixed to 1 bit.

F-MPC60B (UM44xx)

Communication setting

The communication parameters can be set using keys attached to the front of the power monitor unit. Be sure to match the settings to those made on the [Communication Setting] tab window of the editor.

(Underlined setting: default)

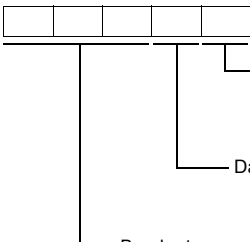
Setting Code	Item	Setting	Example
90	RS-485 address setting	<u>Loc: communication not used</u> 01 to 99	01
91	RS-485 transmission specification	7SEG LED  Parity n: None E: Even o: Odd Data length <u>7: 7 bits</u> 8: 8 bits Baud rate 48: 4800 bps <u>96: 9600 bps</u> 192: 19200 bps	1927o

* The communication parameter (stop bit) is fixed to 1 bit.

FePSU

Communication setting

The communication parameters can be set using keys attached to the front of the power monitor unit. Be sure to match the settings to those made on the [Communication Setting] tab window of the editor.

(Underlined setting: default)

Type	Parameter Display	Item	Setting	Example
SEL-c	Adr. □ □	Communicating station number	<u>Loc: Communication not used</u> 01 to 99	01
	bud □ □	Baud rate	4.8: 4800 bps 9.6: 9600 bps <u>19.2: 19200 bps</u>	19.2
	cbit. □ □	Data length, parity	8n: Data length 8 bits, without parity 8E: Data length 8 bits, even parity 8o: Data length 8 bits, odd parity 7n: Data length 7 bits, without parity 7E: Data length 7 bits, even parity <u>7o: Data length 7 bits, odd parity</u>	7o
	LtY. □ □	Communication Mode	<u>Psu: FePSU mode</u> *1 _PP: PPM(B) mode	Psu

*1 The communication function of FePSU can be selected at the time of purchase. Select a model on which "FePSU mode" is available.

*2 The communication parameter (stop bit) is fixed to 1 bit.

Available Memory

The available memory setting range varies depending on the device. Be sure to set within the range available with the device to be used. Use [TYPE] when assigning the indirect memory for macro programs.

Memory	TYPE	Remarks
00 (data request of circuit No. 1 to 4) *1	00H	Double-word, read only
01 (data request of circuit No. 5 to 8) *1	01H	Double-word, read only
02 (data request of circuit No. 9, 10 or E) *1	02H	Double-word, read only
03 (Data request of the minimum/maximum voltage, power factor of circuit 1 to 10, and invalid power) *1 *2	03H	Double-word, read only
09 (model code)	09H	Read only
10 (operation status)	0AH	Read only
11 (pre-alarm value) *1	0BH	Double-word, read only
12 (current value measurement data) *1 *2	0CH	Double-word, read only
13 (integrated value data) *1 *2	0DH	Double-word, read only
14 (demand measurement data) *1 *2	0EH	Double-word, read only
15 (data of a maximum value of demand measurement) *1 *2	0FH	Double-word, read only
16 (historical data 1) *1 *2	10H	Double-word, read only
17 (historical data 2)	11H	Double-word, read only
18 (setting data) *3	12H	Double-word

*1 When a memory other than status is used, set the decimal point of the numerical display part to "3".

*2 "0" is stored in the address for which "(Blank)" is indicated in the table below.

*3 For setting data, see "Memory: 18 (Setting Data)" described below.

Memory: 18 (Setting Data)

Address	F-MPC04/F-MPC04P/F-MPC04S	FePSU	F-MPC30/F-MPC50/F-MPC55V/F-MPC60B
00zz	Wiring method (voltage measured)	(Blank)	CT primary rated current
01zz	Ratio of VT 1 (primary voltage) *1	(Blank)	Ratio of VT (primary voltage)
02zz	Ratio of VT 1 (secondary voltage) *1	(Blank)	Ratio of VT (secondary voltage)
03zz	Demand average time	Demand average time	Rated frequency
04zz	Frequency	(Blank)	Protective INST (current setting) *2
05zz	Number of applicable circuits	(Blank)	Protective INST (output setting)
06zz	Pulse multiplying factor	(Blank)	Protective DT (current setting) *2
07zz	Ratio of VT 2 (primary voltage) *1	(Blank)	Protective DT (operation time) *2
08zz	Ratio of VT 2 (secondary voltage) *1	(Blank)	Protective DT (output setting) *2
09zz	Number of turns for CT2 secondary line	(Blank)	Protective OC (current setting)
10zz	CT primary current *1	(Blank)	Protective OC (characteristic)
11zz	OCG sensitivity current	(Blank)	Protective OC (time magnification) *2
12zz	OCG operation time *2	(Blank)	Protective OC (output setting)
13zz	Load pre-alarm sensitivity current	(Blank)	Protective OCA overcurrent pre-alarm (current setting)
14zz	Load pre-alarm operation time	(Blank)	Protective OCA overcurrent pre-alarm (operation time)
15zz	Automatic display circuit register	(Blank)	Protective OCA overcurrent pre-alarm (output setting)
16zz	ZCT select	(Blank)	Protective OCG (51G) (current setting) *3
17zz	VT select	(Blank)	Protective OCG (51G) (characteristic)
18zz	(Blank)	(Blank)	Protective OCG (51G) (time magnification) *2
19zz	(Blank)	(Blank)	Protective OCG (51G) (output setting)

Address	F-MPC04/F-MPC04P/F-MPC04S	FePSU	F-MPC30/F-MPC50/F-MPC55V/F-MPC60B
20zz	Phase selection	(Blank)	Protective OCG (50G) (current setting) *2
21zz	Power alarm upper limit	Power alarm upper limit	Protective OCG (50G) (operation time) *2
22zz	Integral power pulse multiplying factor *4	Pulse multiplying factor *4	Protective OCG (50G) (output setting)
23zz	Load pre-alarm operation value	Load pre-alarm operation value	Protective DG (DG/OCG) (current setting) *3
24zz	Load pre-alarm operation time	(Blank)	Protective DG (DG/OCG) (operation time) *3
25zz	Leak pre-alarm sensitivity current	Leak pre-alarm sensitivity current	Protect DG (DG/OCG) (output setting)
26zz	Leak pre-alarm operation time *2	Leak pre-alarm operation time *2	Protective DG (DG/OCG) (maximum sensitivity phase angle)
27zz	OCG sensitivity current	Leak alarm sensitivity current	Protective DG (DG/OCG) (voltage setting) *2
28zz	OCG operation time *2	Leak alarm operation time *2	Protective DG (DG/OCG) (selected from DG or OCG)
29zz	Operation type for power	Operation type for power	Protective 0 V (voltage setting)
30zz	(Blank)	Phase R input position	Protective 0 V (operation time)*2
31zz	(Blank)	History of turning breaker ON	Protective 0 V (output setting)
32zz	(Blank)	Show/hide cause of trouble	Protective UV (voltage setting)
33zz	(Blank)	Phase interruption alarm of neutral line	Protective UV (operation time)*2
34zz	(Blank)	Alarm output 1	Protective UV (output setting)
35zz	(Blank)	Alarm output 2	Protective UV2 (voltage setting)
36zz	(Blank)	Contact input 1	Protective UV2 (operation time)*2
37zz	(Blank)	Contact input 2	Protective UV2 (output setting)
38zz	(Blank)	(Blank)	Protective UV operation setting
39zz	(Blank)	Rated current (IN)	Voltage establishment VR (voltage setting)
40zz	(Blank)	Current demand time	Voltage establishment VR (operation time) *2
41zz	(Blank)	Voltage demand time	Voltage establishment VR (output setting)
42zz	(Blank)	Power demand time	Protective OVG (voltage setting)*2
43zz	(Blank)	Leak demand time	Protective OVG (operation time)
44zz	(Blank)	(Blank)	Protective OVG (output setting)
45zz	(Blank)	(Blank)	ZPD/EVT selection
46zz	(Blank)	(Blank)	Phase interruption relay
47zz	(Blank)	(Blank)	Reverse phase relay
48zz	(Blank)	(Blank)	Demand average time
49zz	(Blank)	Year setting	CB opening jam monitoring time *3
50zz	(Blank)	Month setting	CB closing jam monitoring time *3
51zz	(Blank)	Date setting	Monitoring trip coil TC disconnection, OFF expedited, function application setting
52zz	(Blank)	Hour setting	kWh pulse constant *5
53zz	(Blank)	Minute setting	kvarh pulse constant *5
54zz	(Blank)	(Blank)	Selective input 1 function setting

Address	F-MPC04/F-MPC04P/F-MPC04S	FePSU	F-MPC30/F-MPC50/F-MPC55V/F-MPC60B
55zz	(Blank)	(Blank)	Selective input 2 function setting
56zz	(Blank)	(Blank)	Selective input 3 function setting
57zz	(Blank)	(Blank)	Selective input 4 function setting
58zz	(Blank)	(Blank)	Selective input 5 function setting
59zz	(Blank)	(Blank)	Selective input 6 function setting
60zz	(Blank)	(Blank)	Selective input 7 function setting
61zz	(Blank)	(Blank)	Selective input 8 function setting
62zz	(Blank)	(Blank)	Device fault detection function setting
63zz	(Blank)	(Blank)	Fault pick-up output setting
64zz	(Blank)	(Blank)	Transmission component 1 output setting
65zz	(Blank)	(Blank)	Transmission component 2 output setting
66zz	(Blank)	(Blank)	Distant/direct state output setting
67zz	(Blank)	(Blank)	Transducer output current phase setting
68zz	(Blank)	(Blank)	Transducer output voltage phase setting
69zz	(Blank)	(Blank)	Residue/CT 3rd selection (zero-phase current)
70zz	(Blank)	(Blank)	Protective INST (phase N) (current setting) ^{*2}
71zz	(Blank)	(Blank)	Protective INST (phase N) (output setting)
72zz	(Blank)	(Blank)	Protective OC (phase N) (current setting)
73zz	(Blank)	(Blank)	Protective OC (phase N) (characteristic)
74zz	(Blank)	(Blank)	Protective OC (phase-N) (time magnification) ^{*2}
75zz	(Blank)	(Blank)	Protective OC (phase N) (output setting)
76zz	(Blank)	(Blank)	Protective OCA overcurrent pre-alarm (phase N) (current setting)
77zz	(Blank)	(Blank)	Protective OCA overcurrent pre-alarm (phase N) (operation time)
78zz	(Blank)	(Blank)	Protective OCA overcurrent pre-alarm (phase N) (output setting)
79zz	(Blank)	(Blank)	Protective OCGA pre-alarm (current setting)
80zz	(Blank)	(Blank)	Protective OCGA pre-alarm (operation time)
81zz	(Blank)	(Blank)	Protective OCGA pre-alarm (output setting)
82zz	(Blank)	(Blank)	Protective DT2 (current setting)
83zz	(Blank)	(Blank)	Protective DT2 (operation time) ^{*2}
84zz	(Blank)	(Blank)	Protective DT2 (output setting)
85zz	(Blank)	(Blank)	Transducer output CH1 setting
86zz	(Blank)	(Blank)	Transducer output CH2 setting
87zz	(Blank)	(Blank)	Transducer output CH3 setting
88zz	(Blank)	(Blank)	Transducer output CH4 setting
89zz	(Blank)	(Blank)	Transducer output CH5 setting
90zz	(Blank)	(Blank)	Transducer output CH6 setting
91zz	(Blank)	(Blank)	External change-over function setting of transducer output
92zz	(Blank)	(Blank)	Display mode selection

- *1 When using a direct value, set [DEC (with sign)] for [Display Type] on the [Num. Display] dialog.
- *2 Specify "1" for [Decimal Point] on the [Num. Display] dialog.
- *3 Specify "2" for [Decimal Point] on the [Num. Display] dialog.
- *4 Specify the multiplying factor in the range of -3 to 2.
- *5 Specify the pulse constant in the range of -2 to 4 or F.

Address denotations:

- For the memory for which the circuit number is set (00 to 02, 12 to 18):

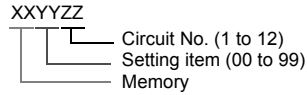

- * For circuit No. E, specify "11" for the circuit number.

- For the memory for which the circuit number is not set (03, 09 to 11):

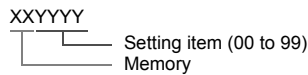

Note on Setting the Memory

Only the "List" file of "F-MPC04S" can be browsed by pressing the [Refer] button by default.

If any power monitor unit other than above is used, refer to each "List" file by pressing the [Refer] button and set the memory.

PLC_CTL

Content	F0	F1 (= \$u n)		F2
kWh integrated value reset	1 - 8 (PLC1 - 8)	n	Station number	2
		n + 1	Command: 0	
Max. kW (amount of power) reset	1 - 8 (PLC1 - 8)	n	Station number	2
		n + 1	Command: 1	
Operation control *1	1 - 8 (PLC1 - 8)	n	Station number	3
		n + 1	Command: 2	
		n + 2	0: Turning ON the input/output 1: Turning ON the output of Power OFF 2: Turning OFF the output of power ON/OFF	
Reset all of the demand maximum values *2	1 - 8 (PLC1 - 8)	n	Station number	2
		n + 1	Command: 3	
Alarm reset *2	1 - 8 (PLC1 - 8)	n	Station number	2
		n + 1	Command: 4	
Time setting *2	1 - 8 (PLC1 - 8)	n	Station number *3	9
		n + 1	Command: 5	
		n + 2	0: Specific station number 1: Broadcast	
		n + 3	Year	
		n + 4	Month	
		n + 5	Day	
		n + 6	Hour	
		n + 7	Minute	
n + 8	Second *4			

*1 Available only with F-MPC60B.

*2 Available only with FePSU.

*3 Select station No. 0 for a broadcast command.

*4 Can be set only for a broadcast command.

15.2.8 FVR-E11S

Communication Setting

Editor

Communication setting

(Underlined setting: default)

Item	Setting	Remarks
Connection Mode	1 : 1 / <u>1 : n</u> / Multi-link2 / Multi-link2 (Ethernet) / 1 : n Multi-link2 (Ethernet)	
Signal Level	<u>RS-422/485</u>	
Baud Rate	4800 / <u>9600</u> / 19200 bps	
Data Length	7 / <u>8</u> bits	
Stop Bit	<u>1</u> / 2 bits	
Parity	<u>None</u> / Odd / Even	
Target Port No.	<u>1</u> to 31	

Inverter

Set communication parameters. Be sure to match the settings to those made on the [Communication Setting] tab window of the editor.

(Underlined setting: default)

Function Code	Item	Setting	Example																				
H30	Link function *1	<table border="1"> <thead> <tr> <th></th> <th>Monitor</th> <th>Frequency</th> <th>Operation Command</th> </tr> </thead> <tbody> <tr> <td>0</td> <td><input type="radio"/></td> <td>X</td> <td>X</td> </tr> <tr> <td>1</td> <td><input type="radio"/></td> <td><input type="radio"/></td> <td>X</td> </tr> <tr> <td>2</td> <td><input type="radio"/></td> <td>X</td> <td><input type="radio"/></td> </tr> <tr> <td>3</td> <td><input type="radio"/></td> <td><input type="radio"/></td> <td><input type="radio"/></td> </tr> </tbody> </table>		Monitor	Frequency	Operation Command	0	<input type="radio"/>	X	X	1	<input type="radio"/>	<input type="radio"/>	X	2	<input type="radio"/>	X	<input type="radio"/>	3	<input type="radio"/>	<input type="radio"/>	<input type="radio"/>	3
	Monitor	Frequency	Operation Command																				
0	<input type="radio"/>	X	X																				
1	<input type="radio"/>	<input type="radio"/>	X																				
2	<input type="radio"/>	X	<input type="radio"/>																				
3	<input type="radio"/>	<input type="radio"/>	<input type="radio"/>																				
H31	Station address	<u>1</u> to 31	1																				
H34	Baud rate	0: 19200 bps <u>1: 9600 bps</u> 2: 4800 bps	1																				
H35	Data length	<u>0: 8 bits</u> 1: 7 bits	0																				
H36	Parity bit	<u>0: None</u> 1: Even 2: Odd	0																				
H37	Stop bit	<u>0: 1 bits</u> 1: 2 bits	0																				
-	Communication protocol *2	"FGL-bus" is set as default.	-																				

*1 Available when the communication is enabled by digital input.

Example: To make the communication enabled when digital input terminal X1 is turned ON;

Set "18 (link operation)" for function code E01 and turn on the digital input terminal X1 externally.

Terminals from X2 to X5 can also be used. Set the function code corresponding to the digital input terminal to use.

*2 When "FVR-E11S" is selected for model selection on the editor, use "FGL-bus" for the communication protocol on the inverter.

Available Memory

The available memory setting range varies depending on the device. Be sure to set within the range available with the device to be used. Use [TYPE] when assigning the indirect memory for macro programs.

Memory	TYPE	Remarks
S (command data)	00H	
M (monitor data)	01H	Double-word
F (basic function)	02H	
E (terminal function)	03H	
C (control function)	04H	
P (motor 1)	05H	
H (high level function)	06H	
A (motor 2)	07H	
o (optional function)	08H	

PLC_CTL

Macro command "PLC_CTL F0 F1 F2"

Contents	F0	F1 (= \$u n)		F2
Reset command	1 - 8 (PLC1 - 8)	n	Station number	2
		n + 1	Command: 0	

15.2.9 FVR-E11S (MODBUS RTU)

Communication Setting

Editor

Communication setting

(Underlined setting: default)

Item	Setting	Remarks
Connection Mode	1 : 1 / <u>1:n</u> / Multi-link2	
Signal Level	RS-422/485	
Baud Rate	4800 / <u>9600</u> / 19200 bps	
Data Length	8 bits	
Stop Bit	<u>1</u> / 2 bits	
Parity	<u>None</u> / Odd / Even	
Target Port No.	<u>1</u> to 31	

Inverter

Be sure to match the communication settings of the inverter to those made on the editor.

Available Memory

The available memory setting range varies depending on the device. Be sure to set within the range available with the device to be used. Use [TYPE] when assigning the indirect memory for macro programs.

Memory	TYPE	Remarks
4	02H	

15.2.10 FVR-C11S (MODBUS RTU)

Communication Setting

Editor

Communication setting

(Underlined setting: default)

Item	Setting	Remarks
Connection Mode	1 : 1 / <u>1:n</u> / Multi-link2	
Signal Level	RS-422/485	
Baud Rate	4800 / <u>9600</u> / 19200 bps	
Data Length	8 bits	
Stop Bit	1 / <u>2</u> bits	
Parity	<u>None</u> / Odd / Even	
Target Port No.	<u>1</u> to 31	

Inverter

Be sure to match the communication settings of the inverter to those made on the editor.

Available Memory

The available memory setting range varies depending on the device. Be sure to set within the range available with the device to be used. Use [TYPE] when assigning the indirect memory for macro programs.

Memory	TYPE	Remarks
4	02H	

15.2.11 FRENIC5000 G11S / P11S

Communication Setting

Editor

Communication setting

(Underlined setting: default)

Item	Setting	Remarks
Connection Mode	1 : 1 / <u>1:n</u> / Multi-link2 / Multi-link2 (Ethernet) / 1 : n Multi-link2 (Ethernet)	
Signal Level	<u>RS-422/485</u>	
Baud Rate	4800 / <u>9600</u> / 19200 bps	
Data Length	7 / <u>8</u> bits	
Stop Bit	1 / <u>2</u> bits	
Parity	<u>None</u> / Odd / Even	
Target Port No.	<u>1</u> to 31	

Inverter

Set communication parameters.

Be sure to match the settings to those made on the [Communication Setting] tab window of the editor.

(Underlined setting: default)

Function Code	Item	Setting	Example																				
H30	Link function *1	<table border="1"> <thead> <tr> <th></th> <th>Writing of Monitor/function Data</th> <th>Frequency Setting</th> <th>Operation Command</th> </tr> </thead> <tbody> <tr> <td><u>0</u></td> <td>○</td> <td>X</td> <td>X</td> </tr> <tr> <td>1</td> <td>○</td> <td>○</td> <td>X</td> </tr> <tr> <td>2</td> <td>○</td> <td>X</td> <td>○</td> </tr> <tr> <td>3</td> <td>○</td> <td>○</td> <td>○</td> </tr> </tbody> </table>		Writing of Monitor/function Data	Frequency Setting	Operation Command	<u>0</u>	○	X	X	1	○	○	X	2	○	X	○	3	○	○	○	3
			Writing of Monitor/function Data	Frequency Setting	Operation Command																		
		<u>0</u>	○	X	X																		
		1	○	○	X																		
		2	○	X	○																		
3	○	○	○																				
H31	Station address	<u>1</u> to 31	1																				
H34	Baud rate	0: 19200 bps <u>1: 9600 bps</u> 2: 4800 bps	1																				
H35	Data length	<u>0: 8 bits</u> 1: 7 bits	0																				
H36	Parity bit	<u>0: None</u> 1: Even 2: Odd	0																				
H37	Stop bit	<u>0: 2 bits</u> 1: 1 bit	0																				
U49	Communication protocol*2	<u>0: FGI-bus</u> 1: Modbus RTU	1																				

*1 Available when the communication is enabled by digital input.

Example: To make the communication enabled when digital input terminal X1 is turned ON;

Set "24 (link operation)" for function code E01 and turn on the digital input terminal X1 externally.

Terminals from X2 to X9 can also be used. Set the function code corresponding to the digital input terminal to use.

*2 When "FRENIC5000G11S/P11S" is selected for model selection on the editor, select "FGI-bus" for the communication protocol on the inverter.

Available Memory

The available memory setting range varies depending on the device. Be sure to set within the range available with the device to be used. Use [TYPE] when assigning the indirect memory for macro programs.

Memory	TYPE	Remarks
S (command data)	00H	
M (monitor data)	01H	Double-word, read only
F (basic function)	02H	
E (terminal function)	03H	
C (control function)	04H	
P (motor 1)	05H	
H (high level function)	06H	
A (motor 2)	07H	
o (optional function)	08H	
U (user function)	0AH	

Indirect Memory Designation

- When "S" (command data) or "M" (monitor data) is used:
Specify the value obtained by subtracting "1" from the real memory address for the memory address number.

PLC_CTL

Macro command "PLC_CTL F0 F1 F2"

Contents	F0	F1 (= \$u n)		F2
Reset command	1 - 8 (PLC1 - 8)	n	Station number	2
		n + 1	Command: 0	

15.2.12 FRENIC5000 G11S / P11S (MODBUS RTU)

Communication Setting

Editor

Communication setting

(Underlined setting: default)

Item	Setting	Remarks
Connection Mode	1 : 1 / <u>1:n</u> / Multi-link2	
Signal Level	RS-422/485	
Baud Rate	4800 / <u>9600</u> / 19200 bps	
Data Length	7 / <u>8</u> bits	
Stop Bit	1 / <u>2</u> bits	
Parity	<u>None</u> / Odd / Even	
Target Port No.	<u>1</u> to 31	

Inverter

Set communication parameters.

Be sure to match the settings to those made on the [Communication Setting] tab window of the editor.

(Underlined setting: default)

Function Code	Item	Setting	Example																				
H30	Link function *1	<table border="1"> <thead> <tr> <th></th> <th>Writing of Monitor/function Data</th> <th>Frequency Setting</th> <th>Operation Command</th> </tr> </thead> <tbody> <tr> <td><u>0</u></td> <td>○</td> <td>X</td> <td>X</td> </tr> <tr> <td>1</td> <td>○</td> <td>○</td> <td>X</td> </tr> <tr> <td>2</td> <td>○</td> <td>X</td> <td>○</td> </tr> <tr> <td>3</td> <td>○</td> <td>○</td> <td>○</td> </tr> </tbody> </table>		Writing of Monitor/function Data	Frequency Setting	Operation Command	<u>0</u>	○	X	X	1	○	○	X	2	○	X	○	3	○	○	○	3
			Writing of Monitor/function Data	Frequency Setting	Operation Command																		
		<u>0</u>	○	X	X																		
		1	○	○	X																		
		2	○	X	○																		
3	○	○	○																				
H31	Station address	<u>1</u> to 31	1																				
H34	Baud rate	0: 19200 bps <u>1: 9600 bps</u> 2: 4800 bps	1																				
H35	Data length	<u>0: 8 bits</u> 1: 7 bits	0																				
H36	Parity bit	<u>0: None</u> 1: Even 2: Odd	0																				
H37	Stop bit	<u>0: 2 bits</u> 1: 1 bit	0																				
U49	Communication protocol*2	<u>0: FGI-bus</u> 1: Modbus RTU	1																				

*1 Available when the communication is enabled by digital input.

Example: To make the communication enabled when digital input terminal X1 is turned ON;

Set "24 (link operation)" for function code E01 and turn on the digital input terminal X1 externally.

Terminals from X2 to X9 can also be used. Set the function code corresponding to the digital input terminal to use.

*2 When "FRENIC5000G11S/P11S (MODBUS RTU)" is selected for model selection on the editor, select "Modbus RTU" for the communication protocol on the inverter.

Available Memory

The available memory setting range varies depending on the device. Be sure to set within the range available with the device to be used. Use [TYPE] when assigning the indirect memory for macro programs.

Memory	TYPE	Remarks
4	02H	

15.2.13 FRENIC5000 VG7S (MODBUS RTU)

Communication Setting

Editor

Communication setting

(Underlined setting: default)

Item	Setting	Remarks
Connection Mode	1 : 1 / <u>1:n</u> / Multi-link2	
Signal Level	RS-422/485	
Baud Rate	4800 / 9600 / 19200 / <u>38400</u> bps	
Data Length	8 bits	Do not change the default setting because the setting on the inverter cannot be changed.
Stop Bit	<u>1</u> / 2 bits* ¹	
Parity	None / Odd / <u>Even</u>	
Target Port No.	<u>1</u> to 31	

*¹ When no parity setting is made, set "2 bits" for stop bit.
When a parity setting (even or odd) is made, set "1 bit" for stop bit.

When Connecting to the Built-in RS-485 Port on the Inverter:

Set communication parameters.

Be sure to match the settings to those made on the [Communication Setting] tab window of the editor.

(Underlined setting: default)

Function Code	Item	Setting	Example																				
H30	Link function * ¹	<table border="1"> <thead> <tr> <th></th> <th>Writing of Monitor/function Data</th> <th>Frequency Setting</th> <th>Operation Command</th> </tr> </thead> <tbody> <tr> <td><u>0</u></td> <td>○</td> <td>X</td> <td>X</td> </tr> <tr> <td>1</td> <td>○</td> <td>○</td> <td>X</td> </tr> <tr> <td>2</td> <td>○</td> <td>X</td> <td>○</td> </tr> <tr> <td>3</td> <td>○</td> <td>○</td> <td>○</td> </tr> </tbody> </table>		Writing of Monitor/function Data	Frequency Setting	Operation Command	<u>0</u>	○	X	X	1	○	○	X	2	○	X	○	3	○	○	○	3
			Writing of Monitor/function Data	Frequency Setting	Operation Command																		
		<u>0</u>	○	X	X																		
		1	○	○	X																		
		2	○	X	○																		
3	○	○	○																				
H31	Station address	<u>1</u> to 31	1																				
H34	Baud rate	<u>0: 38400 bps</u> 1: 19200 bps 2: 9600 bps 3: 4800 bps	0																				
H36	Parity bit	0: None <u>1: Even</u> 2: Odd	1																				
H37	Stop bit	For Modbus RTU communication, the stop bit setting is automatically made according to the parity bit setting. When no parity setting is made, "2 bits" is set for stop bit. When a parity setting (even or odd) is made, "1 bit" is set for stop bit.	1																				
H40	Communication protocol* ²	0: FGI-bus <u>1: SX (loader) protocol</u> 2: Modbus RTU	2																				

* The communication parameter (data length) is fixed to 8 bits.

When Connecting to the Terminal Block on “OPC-VG7-RS” (Optional Communication Board):

Communication setting

Set communication parameters.

Be sure to match the settings to those made on the [Communication Setting] tab window of the editor.

(Underlined setting: default)

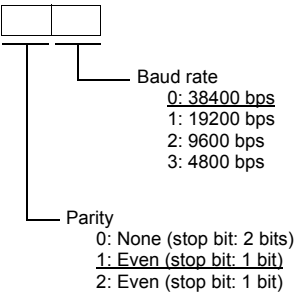
Function Code	Item	Setting	Example																				
H30	Link function *1	<table border="1"> <thead> <tr> <th></th> <th>Writing of Monitor/function Data</th> <th>Frequency Setting</th> <th>Operation Command</th> </tr> </thead> <tbody> <tr> <td>0</td> <td>○</td> <td>X</td> <td>X</td> </tr> <tr> <td>1</td> <td>○</td> <td>○</td> <td>X</td> </tr> <tr> <td>2</td> <td>○</td> <td>X</td> <td>○</td> </tr> <tr> <td>3</td> <td>○</td> <td>○</td> <td>○</td> </tr> </tbody> </table>		Writing of Monitor/function Data	Frequency Setting	Operation Command	0	○	X	X	1	○	○	X	2	○	X	○	3	○	○	○	3
			Writing of Monitor/function Data	Frequency Setting	Operation Command																		
		0	○	X	X																		
		1	○	○	X																		
		2	○	X	○																		
3	○	○	○																				
H31	Station address	1 to 31	1																				
o37	Communication definition setting		10																				
		H40		Communication protocol *2	0: FGI-bus 1: <u>SX (loader) protocol</u> 2: <u>Modbus RTU</u>	2																	

*1 Available when the communication is enabled by digital input.

Example: To make the communication enabled when digital input terminal X1 is turned ON;

Set “24 (link operation)” for function code E01 and turn on the digital input terminal X1 externally.

Terminals from X2 to X9 can also be used. Set the function code corresponding to the digital input terminal to use.

*2 When “FRENIC5000G11S/P11S (MODBUS RTU)” is selected for model selection on the editor, select “Modbus RTU” for the communication protocol on the inverter.

*3 The communication parameter (data length) is fixed to 8 bits.

Notes on Using “OPC-VG7-RS” (Optional Communication Board)

Set the DIPSW2 on the optional communication board “OPC-VG7-RS” as shown below when connecting the TS and the terminal block of the board.

The underlined settings are set as default.

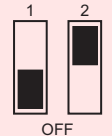
SW2	SW2-1 Setting	SW2-2 Setting	Function	Remarks
	OFF	OFF	-	-
	ON	OFF	-	-
	<u>OFF</u>	<u>ON</u>	Optional communication board enabled	Do not change the default setting when connecting with the TS.
	ON	ON	-	-

Available Memory

The available memory setting range varies depending on the device. Be sure to set within the range available with the device to be used. Use [TYPE] when assigning the indirect memory for macro programs.

Memory	TYPE	Remarks
4	02H	

15.2.14 FRENIC-Mini (MODBUS RTU)

Communication Setting

Editor

Communication setting

(Underlined setting: default)

Item	Setting	Remarks
Connection Mode	1 : 1 / <u>1:n</u> / Multi-link2	
Signal Level	<u>RS-422/485</u>	
Baud Rate	4800 / 9600 / <u>19200</u> bps	
Data Length	8 bits	Do not change the default setting because the setting on the inverter cannot be changed.
Stop bit	1 / <u>2 bits</u> *1	
Parity	<u>None</u> / Odd / Even	
Target Port No.	<u>1</u> to 31	

*1 When no parity setting is made, "2 bits" is set for stop bit.
When a parity setting (even or odd) is made, "1 bit" is set for stop bit.

Inverter

Set communication parameters.

Be sure to match the settings to those made on the [Communication Setting] tab window of the editor.

(Underlined setting: default)

Function Code	Item	Setting	Example															
y01	Station address	<u>1</u> to 31	1															
y04	Baud rate	1: 4800 bps 2: 9600 bps <u>3: 19200 bps</u>	3															
y06	Parity bit	<u>0: None</u> 1: Even 2: Odd	0															
y07	Stop bit	For Modbus RTU communication, the stop bit setting is automatically made according to the parity bit setting. When no parity setting is made, "2 bits" is set for stop bit. When a parity setting (even or odd) is made, "1 bit" is set for stop bit.	-															
y10	Communication protocol*1	0: Modbus RTU <u>1: SX (loader) protocol</u> 2: FGI-bus	0															
y99	Support link function	<table border="1"> <thead> <tr> <th></th> <th>Frequency</th> <th>Operation Command</th> </tr> </thead> <tbody> <tr> <td><u>0</u></td> <td>Function code H30</td> <td>Function code H30</td> </tr> <tr> <td>1</td> <td>Commanded from RS-485</td> <td>Function code H30</td> </tr> <tr> <td>2</td> <td>Function code H30</td> <td>Commanded from RS-485</td> </tr> <tr> <td>3</td> <td>Commanded from RS-485</td> <td>Commanded from RS-485</td> </tr> </tbody> </table>		Frequency	Operation Command	<u>0</u>	Function code H30	Function code H30	1	Commanded from RS-485	Function code H30	2	Function code H30	Commanded from RS-485	3	Commanded from RS-485	Commanded from RS-485	0
	Frequency	Operation Command																
<u>0</u>	Function code H30	Function code H30																
1	Commanded from RS-485	Function code H30																
2	Function code H30	Commanded from RS-485																
3	Commanded from RS-485	Commanded from RS-485																
H30	Link function *2	<table border="1"> <thead> <tr> <th></th> <th>Frequency</th> <th>Operation Command</th> </tr> </thead> <tbody> <tr> <td><u>0</u></td> <td>Inverter</td> <td>Inverter</td> </tr> <tr> <td>1</td> <td>RS-485 communication</td> <td>Inverter</td> </tr> <tr> <td>2</td> <td>Inverter</td> <td>RS-485 communication</td> </tr> <tr> <td>3</td> <td>RS-485 communication</td> <td>RS-485 communication</td> </tr> </tbody> </table>		Frequency	Operation Command	<u>0</u>	Inverter	Inverter	1	RS-485 communication	Inverter	2	Inverter	RS-485 communication	3	RS-485 communication	RS-485 communication	3
	Frequency	Operation Command																
<u>0</u>	Inverter	Inverter																
1	RS-485 communication	Inverter																
2	Inverter	RS-485 communication																
3	RS-485 communication	RS-485 communication																

*1 Select "Modbus RTU" for the communication protocol on the inverter when connecting with the TS.

*2 When "0" is specified for y99 (support link function), command from function code H30 is valid for the frequency setting and operation command.

*3 The communication parameter (data length) is fixed to 8 bits.

Available Memory

The available memory setting range varies depending on the device. Be sure to set within the range available with the device to be used. Use [TYPE] when assigning the indirect memory for macro programs.

Memory	TYPE	Remarks
---	02H	

Address denotations XXYY

Function code identification number
 Function code group

Group	Code	Name
F	00H	Basic function
E	01H	Terminal function
C	02H	Control function
P	03H	Motor parameter
H	04H	High level function
S	07H	Command/function data
M	08H	Monitor data
J	0DH	Application function
y	0EH	Link function
W	0FH	Monitor 2
X	10H	Alarm 1
Z	11H	Alarm 2

15.2.15 FRENIC-Eco (MODBUS RTU)

Communication Setting

Editor

Communication setting

(Underlined setting: default)

Item	Setting	Remarks
Connection Mode	1 : 1 / <u>1:n</u> / Multi-link2	
Signal Level	<u>RS-422/485</u>	
Baud Rate	4800 / 9600 / <u>19200</u> / 38400 bps	
Data Length	<u>8 bits</u>	Do not change the default setting because the setting on the inverter cannot be changed.
Stop Bit	1 / <u>2</u> bits	When no parity setting is made, "2 bits" is set for stop bit.
Parity	<u>None</u> / Odd / Even	When a parity setting is made, "1 bit" is set for stop bit.
Target Port No.	<u>1</u> to 31	

Inverter

Set communication parameters.

Be sure to match the settings to those made on the [Communication Setting] tab window of the editor.

(Underlined setting: default)

Function Code	Item	Setting	Example															
y01	Station address	<u>1</u> to 31	1															
y04	Baud rate	1: 4800 bps 2: 9600 bps 3: <u>19200 bps</u> 4: 38400 bps	3															
y06	Parity bit	0: <u>None</u> 1: Even 2: Odd	0															
y07	Stop bit	For Modbus RTU communication, the stop bit setting is automatically made according to the parity bit setting. When no parity setting is made, "2 bits" is set for stop bit. When a parity setting (even or odd) is made, "1 bit" is set for stop bit.	-															
y10	Communication protocol ^{*1}	0: <u>Modbus RTU</u> 1: <u>SX (loader) protocol</u> 2: FGI-bus	0															
y11	Station address	<u>1</u> to 31	1															
y14	Baud rate	1: 4800 bps 2: 9600 bps 3: <u>19200 bps</u> 4: 38400 bps	3															
y16	Parity bit	0: <u>None</u> 1: Even 2: Odd	0															
y17	Stop bit	For Modbus RTU communication, the stop bit setting is automatically made according to the parity bit setting. When no parity setting is made, "2 bits" is set for stop bit. When a parity setting (even or odd) is made, "1 bit" is set for stop bit.	-															
y20	Communication protocol ^{*1}	0: <u>Modbus RTU</u> 2: FGI-bus	0															
y98	Bus function	<table border="1"> <thead> <tr> <th></th> <th>Frequency</th> <th>Operation Command</th> </tr> </thead> <tbody> <tr> <td><u>0</u></td> <td>Function code H30</td> <td>Function code H30</td> </tr> <tr> <td>1</td> <td>Commanded from the fieldbus</td> <td>Function code H30</td> </tr> <tr> <td>2</td> <td>Function code H30</td> <td>Commanded from the fieldbus</td> </tr> <tr> <td>3</td> <td>Commanded from the fieldbus</td> <td>Commanded from the fieldbus</td> </tr> </tbody> </table>		Frequency	Operation Command	<u>0</u>	Function code H30	Function code H30	1	Commanded from the fieldbus	Function code H30	2	Function code H30	Commanded from the fieldbus	3	Commanded from the fieldbus	Commanded from the fieldbus	0
	Frequency	Operation Command																
<u>0</u>	Function code H30	Function code H30																
1	Commanded from the fieldbus	Function code H30																
2	Function code H30	Commanded from the fieldbus																
3	Commanded from the fieldbus	Commanded from the fieldbus																
y99	Support link function	<table border="1"> <thead> <tr> <th></th> <th>Frequency</th> <th>Operation Command</th> </tr> </thead> <tbody> <tr> <td><u>0</u></td> <td>Function code H30, y98</td> <td>Function code H30, y98</td> </tr> <tr> <td>1</td> <td>Commanded from RS-485</td> <td>Function code H30, y98</td> </tr> <tr> <td>2</td> <td>Function code H30, y98</td> <td>Commanded from RS-485</td> </tr> <tr> <td>3</td> <td>Commanded from RS-485</td> <td>Commanded from RS-485</td> </tr> </tbody> </table>		Frequency	Operation Command	<u>0</u>	Function code H30, y98	Function code H30, y98	1	Commanded from RS-485	Function code H30, y98	2	Function code H30, y98	Commanded from RS-485	3	Commanded from RS-485	Commanded from RS-485	0
	Frequency	Operation Command																
<u>0</u>	Function code H30, y98	Function code H30, y98																
1	Commanded from RS-485	Function code H30, y98																
2	Function code H30, y98	Commanded from RS-485																
3	Commanded from RS-485	Commanded from RS-485																

Function Code	Item	Setting		Example
H30	Link function *2			3

*1 Select "Modbus RTU" for the communication protocol on the inverter when connecting with the TS.

*2 When "0" is specified for y98 (bus function) as well as y99 (support link function), the frequency and operation command can be set on the TS.

When making the frequency and operation command settings on the TS connected to the connector for the touch panel, specify "3" for function code H30. When making those settings on the TS connected to the optional communication board, specify "8" for function code H30.

*3 The communication parameter (data length) is fixed to 8 bits.

Available Memory

The available memory setting range varies depending on the device. Be sure to set within the range available with the device to be used. Use [TYPE] when assigning the indirect memory for macro programs.

Memory	TYPE	Remarks
4	02H	

15.2.16 FRENIC-Multi (MODBUS RTU)

Communication Setting

Editor

Communication setting

(Underlined setting: default)

Item	Setting	Remarks
Connection Mode	1 : 1 / <u>1:n</u> / Multi-link2	
Signal Level	RS-422/485	
Baud Rate	4800 / 9600 / <u>19200</u> / 38400 bps	
Data Length	8 bits	Do not change the default setting because the setting on the inverter cannot be changed.
Stop Bit	1 / <u>2</u> bits	On the inverter: 2 bits when "0" is specified for y06 or y16 1 bit when "1", "2" or "3" is specified for y06 or y16
Parity	<u>None</u> / Odd / Even	
Target Port No.	<u>1</u> to 31	

Inverter

Set communication parameters.

Be sure to match the settings to those made on the [Communication Setting] tab window of the editor.

(Underlined setting: default)

Function Code	Item	Setting	Example															
y01	Station address	<u>1</u> to 31	1															
y04	Baud rate	1: 4800 bps 2: 9600 bps 3: <u>19200 bps</u> 4: 38400 bps	3															
y06	Parity bit	<u>0: None</u> 1: Even 2: Odd 3: None	0															
y07	Stop bit	For Modbus RTU communication, the stop bit setting is automatically made according to the parity bit setting. When "0" is specified for y06, "2 bits" is set for stop bit. When "1", "2", or "3" is specified for y06, "1 bit" is set for stop bit.	-															
y10	Communication protocol ^{*1}	0: Modbus RTU <u>1: SX (loader) protocol</u> 2: FGI-bus	0															
y11	Station address	<u>1</u> to 31	1															
y14	Baud rate	1: 4800 bps 2: 9600 bps 3: <u>19200 bps</u> 4: 38400 bps	3															
y16	Parity bit	<u>0: None</u> 1: Even 2: Odd 3: None	0															
y17	Stop bit	For Modbus RTU communication, the stop bit setting is automatically made according to the parity bit setting. When "0" is specified for y16, "2 bits" is set for stop bit. When "1", "2", or "3" is specified for y16, "1 bit" is set for stop bit.	-															
y20	Communication protocol ^{*1}	0: Modbus RTU 2: FGI-bus	0															
y98	Bus function	<table border="1"> <thead> <tr> <th></th> <th>Frequency</th> <th>Operation Command</th> </tr> </thead> <tbody> <tr> <td><u>0</u></td> <td>Function code H30</td> <td>Function code H30</td> </tr> <tr> <td>1</td> <td>Commanded from the fieldbus</td> <td>Function code H30</td> </tr> <tr> <td>2</td> <td>Function code H30</td> <td>Commanded from the fieldbus</td> </tr> <tr> <td>3</td> <td>Commanded from the fieldbus</td> <td>Commanded from the fieldbus</td> </tr> </tbody> </table>		Frequency	Operation Command	<u>0</u>	Function code H30	Function code H30	1	Commanded from the fieldbus	Function code H30	2	Function code H30	Commanded from the fieldbus	3	Commanded from the fieldbus	Commanded from the fieldbus	0
	Frequency	Operation Command																
<u>0</u>	Function code H30	Function code H30																
1	Commanded from the fieldbus	Function code H30																
2	Function code H30	Commanded from the fieldbus																
3	Commanded from the fieldbus	Commanded from the fieldbus																

Function Code	Item	Setting		Example	
y99	Support link function			0	
		0	Function code H30, y98		Function code H30, y98
		1	Commanded from RS-485		Function code H30, y98
		2	Function code H30, y98		Commanded from RS-485
H30	Link function *2			3	
		0	Inverter		Inverter
		1	RS-485 communication		Inverter
		2	Inverter		RS-485 communication
		3	RS-485 communication		RS-485 communication
		4	RS-485 communication (optional)		Inverter
		5	RS-485 communication (optional)		RS-485 communication
		6	Inverter		RS-485 communication (optional)
		7	RS-485 communication		RS-485 communication (optional)
8	RS-485 communication (optional)	RS-485 communication (optional)			

*1 Select "Modbus RTU" for the communication protocol on the inverter when connecting with the TS.

*2 When "0" is specified for y98 (bus function) as well as y99 (support link function), the frequency and operation command can be set on the TS.
When making the frequency and operation command settings on the TS connected to the connector for the touch panel, specify "3" for function code H30. When making those settings on the TS connected to the optional communication board, specify "8" for function code H30.

*3 The communication parameter (data length) is fixed to 8 bits.

Available Memory

The available memory setting range varies depending on the device. Be sure to set within the range available with the device to be used. Use [TYPE] when assigning the indirect memory for macro programs.

Memory	TYPE	Remarks
4	02H	

15.2.17 FRENIC-MEGA (MODBUS RTU)

Communication Setting

Editor

Communication setting

(Underlined setting: default)

Item	Setting	Remarks
Connection Mode	1 : 1 / <u>1:n</u> / Multi-link2	
Signal Level	RS-422/485	
Baud Rate	4800 / 9600 / <u>19200</u> / 38400 bps	
Data Length	8 bits	Do not change the default setting because the setting on the inverter cannot be changed.
Stop Bit	1 / <u>2</u> bits	On the inverter: 2 bits when "0" is specified for y06 or y16 1 bit when "1", "2" or "3" is specified for y06 or y16
Parity	<u>None</u> / Odd / Even	
Target Port No.	<u>1</u> to 31	

Inverter

Set communication parameters.

Be sure to match the settings to those made on the [Communication Setting] tab window of the editor.

(Underlined setting: default)

Function Code	Item	Setting	Example															
y01	Station address	<u>1</u> to 31	1															
y04	Baud rate	1: 4800 bps 2: 9600 bps 3: <u>19200 bps</u> 4: 38400 bps	3															
y06	Parity bit	<u>0: None</u> 1: Even 2: Odd 3: None	0															
y07	Stop bit	For Modbus RTU communication, the stop bit setting is automatically made according to the parity bit setting. When "0" is specified for y06, "2 bits" is set for stop bit. When "1", "2", or "3" is specified for y06, "1 bit" is set for stop bit.	-															
y10	Communication protocol ^{*1}	0: Modbus RTU <u>1: SX (loader) protocol</u> 2: FGI-bus	0															
y11	Station address	<u>1</u> to 31	1															
y14	Baud rate	1: 4800 bps 2: 9600 bps 3: <u>19200 bps</u> 4: 38400 bps	3															
y16	Parity bit	<u>0: None</u> 1: Even 2: Odd 3: None	0															
y17	Stop bit	For Modbus RTU communication, the stop bit setting is automatically made according to the parity bit setting. When "0" is specified for y16, "2 bits" is set for stop bit. When "1", "2", or "3" is specified for y16, "1 bit" is set for stop bit.	-															
y20	Communication protocol ^{*1}	0: Modbus RTU 2: FGI-bus	0															
y98	Bus function	<table border="1"> <thead> <tr> <th></th> <th>Frequency</th> <th>Operation Command</th> </tr> </thead> <tbody> <tr> <td><u>0</u></td> <td>Function code H30</td> <td>Function code H30</td> </tr> <tr> <td>1</td> <td>Commanded from the fieldbus</td> <td>Function code H30</td> </tr> <tr> <td>2</td> <td>Function code H30</td> <td>Commanded from the fieldbus</td> </tr> <tr> <td>3</td> <td>Commanded from the fieldbus</td> <td>Commanded from the fieldbus</td> </tr> </tbody> </table>		Frequency	Operation Command	<u>0</u>	Function code H30	Function code H30	1	Commanded from the fieldbus	Function code H30	2	Function code H30	Commanded from the fieldbus	3	Commanded from the fieldbus	Commanded from the fieldbus	0
	Frequency	Operation Command																
<u>0</u>	Function code H30	Function code H30																
1	Commanded from the fieldbus	Function code H30																
2	Function code H30	Commanded from the fieldbus																
3	Commanded from the fieldbus	Commanded from the fieldbus																

Function Code	Item	Setting		Example	
y99	Support link function		Frequency	Operation Command	0
		0	Function code H30, y98	Function code H30, y98	
		1	Commanded from the loader	Function code H30, y98	
		2	Function code H30, y98	Commanded from the loader	
H30	Link function *2		Frequency	Operation Command	3
		0	Inverter	Inverter	
		1	RS-485 communication	Inverter	
		2	Inverter	RS-485 communication	
		3	RS-485 communication	RS-485 communication	
		4	RS-485 communication (control circuit)	Inverter	
		5	RS-485 communication (control circuit)	RS-485 communication	
		6	Inverter	RS-485 communication (control circuit)	
7	RS-485 communication	RS-485 communication (control circuit)			
8	RS-485 communication (control circuit)	RS-485 communication (control circuit)			

*1 Select "Modbus RTU" for the communication protocol on the inverter when connecting with the TS.

*2 When "0" is specified for y98 (bus function) as well as y99 (support link function), the frequency and operation command can be set on the TS.
When making the frequency and operation command settings on the TS connected to the connector for the touch panel, specify "3" for function code H30. When making those settings on the TS connected to the terminal block on control circuit, specify "8" for function code H30.

*3 The communication parameter (data length) is fixed to 8 bits.

Available Memory

The available memory setting range varies depending on the device. Be sure to set within the range available with the device to be used. Use [TYPE] when assigning the indirect memory for macro programs.

Memory	TYPE	Remarks
4	02H	

15.2.18 FRENIC-MEGA SERVO (MODBUS RTU)

Communication Setting

Editor

Communication setting

(Underlined setting: default)

Item	Setting	Remarks
Connection Mode	1 : 1 / <u>1:n</u> / Multi-link2 / Multi-link2 (Ethernet) / 1 : n Multi-link2 (Ethernet)	
Signal Level	<u>RS-422/485</u>	
Baud Rate	4800 / 9600 / <u>19200</u> / 38400 bps	
Data Length	<u>8</u> bits	
Stop Bit	1 / <u>2</u> bits	On the inverter: 2 bits when "0" is specified for y06 or y16 1 bit when "1", "2" or "3" is specified for y06 or y16
Parity	<u>None</u> / Odd / Even	
Target Port No.	0 to 247	0: Broadcast

Inverter

Set communication parameters.

Be sure to match the settings to those made on the [Communication Setting] tab window of the editor.

(Underlined setting: default)

Function Code	Item	Setting	Example															
y01	Station address	<u>1</u> to 247	1															
y04	Baud rate	1: 4800 bps 2: 9600 bps <u>3: 19200 bps</u> 4: 38400 bps	3															
y06	Parity bit	<u>0: None</u> 1: Even 2: Odd 3: None	0															
y07	Stop bit	For Modbus RTU communication, the stop bit setting is automatically made according to the parity bit setting. When "0" is specified for y06, "2 bits" is set for stop bit. When "1", "2", or "3" is specified for y06, "1 bit" is set for stop bit.	-															
y10	Communication protocol *1	0: Modbus RTU <u>1: SX (loader) protocol</u> 2: FGI-bus	0															
y11	Station address	<u>1</u> to 247	1															
y14	Baud rate	1: 4800 bps 2: 9600 bps <u>3: 19200 bps</u> 4: 38400 bps	3															
y16	Parity bit	<u>0: None</u> 1: Even 2: Odd 3: None	0															
y17	Stop bit	For Modbus RTU communication, the stop bit setting is automatically made according to the parity bit setting. When "0" is specified for y16, "2 bits" is set for stop bit. When "1", "2", or "3" is specified for y16, "1 bit" is set for stop bit.	-															
y20	Communication protocol *1	0: Modbus RTU 2: FGI-bus	0															
y98	Bus function	<table border="1"> <thead> <tr> <th></th> <th>Frequency</th> <th>Operation Command</th> </tr> </thead> <tbody> <tr> <td><u>0</u></td> <td>Function code H30</td> <td>Function code H30</td> </tr> <tr> <td>1</td> <td>Commanded from the fieldbus</td> <td>Function code H30</td> </tr> <tr> <td>2</td> <td>Function code H30</td> <td>Commanded from the fieldbus</td> </tr> <tr> <td>3</td> <td>Commanded from the fieldbus</td> <td>Commanded from the fieldbus</td> </tr> </tbody> </table>		Frequency	Operation Command	<u>0</u>	Function code H30	Function code H30	1	Commanded from the fieldbus	Function code H30	2	Function code H30	Commanded from the fieldbus	3	Commanded from the fieldbus	Commanded from the fieldbus	0
	Frequency	Operation Command																
<u>0</u>	Function code H30	Function code H30																
1	Commanded from the fieldbus	Function code H30																
2	Function code H30	Commanded from the fieldbus																
3	Commanded from the fieldbus	Commanded from the fieldbus																

Function Code	Item	Setting			Example
y99	Support link function		Frequency	Operation Command	0
		0	Function code H30, y98	Function code H30, y98	
		1	Commanded from FRENIC loader	Function code H30, y98	
		2	Function code H30, y98	Commanded from FRENIC loader	
		3	Commanded from FRENIC loader	Commanded from FRENIC loader	
H30	Link function *2		Frequency	Operation Command	3
		0	Inverter	Inverter	
		1	RS-485 communication	Inverter	
		2	Inverter	RS-485 communication	
		3	RS-485 communication	RS-485 communication	
		4	RS-485 communication (Control circuit)	Inverter	
		5	RS-485 communication (Control circuit)	RS-485 communication	
		6	Inverter	RS-485 communication (Control circuit)	
		7	RS-485 communication	RS-485 communication (Control circuit)	
8	RS-485 communication (Control circuit)	RS-485 communication (Control circuit)			

*1 Select "Modbus RTU" for the communication protocol on the inverter when connecting with the TS.

*2 When "0" is specified for y98 (bus function) as well as y99 (support link function), the frequency and operation command can be set on the TS.

When making frequency and operation command settings on the TS connected to the connector for the touch panel, specify "3" for function code H30. When making the settings on the TS connected to the control circuit terminal block, specify "8" for H30.

*3 The communication parameter (data length) is fixed to 8 bits.

Available Memory

The available memory setting range varies depending on the device. Be sure to set within the range available with the device to be used. Use [TYPE] when assigning the indirect memory for macro programs.

Memory	TYPE	Remarks
4	02H	

15.2.19 FRENIC-HVAC/AQUA (MODBUS RTU)

Communication Setting

Editor

Communication setting

(Underlined setting: default)

Item	Setting	Remarks
Connection Mode	1 : 1 / <u>1 : n</u> / Multi-link2 / Multi-link2 (Ethernet) / 1 : n Multi-link2 (Ethernet)	
Signal Level	<u>RS-422/485</u>	
Baud Rate	4800 / 9600 / <u>19200</u> / 38400 bps	
Data Length	<u>8</u> bits	
Stop Bit	1 / <u>2</u> bits	On the inverter: 2 bits when "0" is specified for y06 or y16 1 bit when "1", "2" or "3" is specified for y06 or y16
Parity	<u>None</u> / Odd / Even	
Target Port No.	0 to 247	0: Broadcast

Inverter

Set communication parameters.

Be sure to match the settings to those made on the [Communication Setting] tab window of the editor.

(Underlined setting: default)

Function Code	Item	Setting	Example															
y01	Station address	<u>1</u> to 247	1															
y04	Baud rate	1: 4800 bps 2: 9600 bps <u>3: 19200 bps</u> 4: 38400 bps	3															
y06	Parity bit	<u>0: None</u> 1: Even 2: Odd 3: None	0															
y07	Stop bit	For Modbus RTU communication, the stop bit setting is automatically made according to the parity bit setting. When "0" is specified for y06, "2 bits" is set for stop bit. When "1", "2", or "3" is specified for y06, "1 bit" is set for stop bit.	-															
y10	Communication protocol *1	0: Modbus RTU	0															
y11	Station address	<u>1</u> to 247	1															
y14	Baud rate	1: 4800 bps 2: 9600 bps <u>3: 19200 bps</u> 4: 38400 bps	3															
y16	Parity bit	<u>0: None</u> 1: Even 2: Odd 3: None	0															
y17	Stop bit	For Modbus RTU communication, the stop bit setting is automatically made according to the parity bit setting. When "0" is specified for y16, "2 bits" is set for stop bit. When "1", "2", or "3" is specified for y16, "1 bit" is set for stop bit.	-															
y20	Communication protocol *1	0: Modbus RTU	0															
y98	Bus function	<table border="1"> <thead> <tr> <th></th> <th>Frequency</th> <th>Operation Command</th> </tr> </thead> <tbody> <tr> <td><u>0</u></td> <td>Function code H30</td> <td>Function code H30</td> </tr> <tr> <td>1</td> <td>Commanded from the fieldbus</td> <td>Function code H30</td> </tr> <tr> <td>2</td> <td>Function code H30</td> <td>Commanded from the fieldbus</td> </tr> <tr> <td>3</td> <td>Commanded from the fieldbus</td> <td>Commanded from the fieldbus</td> </tr> </tbody> </table>		Frequency	Operation Command	<u>0</u>	Function code H30	Function code H30	1	Commanded from the fieldbus	Function code H30	2	Function code H30	Commanded from the fieldbus	3	Commanded from the fieldbus	Commanded from the fieldbus	0
	Frequency	Operation Command																
<u>0</u>	Function code H30	Function code H30																
1	Commanded from the fieldbus	Function code H30																
2	Function code H30	Commanded from the fieldbus																
3	Commanded from the fieldbus	Commanded from the fieldbus																

Function Code	Item	Setting			Example
y99	Support link function		Frequency	Operation Command	0
		0	Function code H30, y98	Function code H30, y98	
		1	Commanded from FRENIC loader	Function code H30, y98	
		2	Function code H30, y98	Command from FRENIC loader	
		3	Command from FRENIC loader	Command from FRENIC loader	
H30	Link function *2		Frequency	Operation command	3
		0	Inverter	Inverter	
		1	RS-485 communication	Inverter	
		2	Inverter	RS-485 communication	
		3	RS-485 communication	RS-485 communication	
		4	RS-485 communication (Control circuit)	Inverter	
		5	RS-485 communication (Control circuit)	RS-485 communication	
		6	Inverter	RS-485 communication (Control circuit)	
		7	RS-485 communication	RS-485 communication (Control circuit)	
8	RS-485 communication (Control circuit)	RS-485 communication (Control circuit)			

*1 Select "Modbus RTU" for the communication protocol on the inverter when connecting with the TS.

*2 When "0" is specified for y98 (bus function) as well as y99 (support link function), the frequency and operation command can be set on the TS.

When making frequency and operation command settings on the TS connected to the connector for the touch panel, specify "3" for function code H30. When making the settings on the TS connected to the control circuit terminal block, specify "8" for H30.

*3 The communication parameter (data length) is fixed to 8 bits.

Available Memory

The available memory setting range varies depending on the device. Be sure to set within the range available with the device to be used. Use [TYPE] when assigning the indirect memory for macro programs.

Memory	TYPE	Remarks
4	02H	

15.2.20 HFR-C9K

Communication Setting

Editor

Communication setting

(Underlined setting: default)

Item	Setting	Remarks
Connection Mode	1 : 1 / <u>1:n</u> / Multi-link2	
Signal Level	RS-422/485	
Baud Rate	4800 / <u>9600</u> / 19200 bps	
Data Length	7 / <u>8</u> bits	
Stop Bit	1 / <u>2</u> bits	
Parity	None / Odd / <u>Even</u>	
Target Port No.	<u>1</u> to 31	

IH Inverter

Be sure to match the settings to those made on the [Communication Setting] tab window of the editor.

SW1 setting (Station address / Optional selection)

Switch	Contents	Example:																																																												
1 2 3 4 5	<table border="1"> <thead> <tr> <th>Switch Address</th> <th>1</th> <th>2</th> <th>3</th> <th>4</th> <th>5</th> </tr> </thead> <tbody> <tr> <td>0</td> <td>OFF</td> <td>OFF</td> <td>OFF</td> <td>OFF</td> <td>OFF</td> </tr> <tr> <td>1</td> <td>ON</td> <td>OFF</td> <td>OFF</td> <td>OFF</td> <td>OFF</td> </tr> <tr> <td>2</td> <td>OFF</td> <td>ON</td> <td>OFF</td> <td>OFF</td> <td>OFF</td> </tr> <tr> <td>3</td> <td>ON</td> <td>ON</td> <td>OFF</td> <td>OFF</td> <td>OFF</td> </tr> <tr> <td>:</td> <td>:</td> <td>:</td> <td>:</td> <td>:</td> <td>:</td> </tr> <tr> <td>28</td> <td>OFF</td> <td>OFF</td> <td>ON</td> <td>ON</td> <td>ON</td> </tr> <tr> <td>29</td> <td>ON</td> <td>OFF</td> <td>ON</td> <td>ON</td> <td>ON</td> </tr> <tr> <td>30</td> <td>OFF</td> <td>ON</td> <td>ON</td> <td>ON</td> <td>ON</td> </tr> <tr> <td>31</td> <td>ON</td> <td>ON</td> <td>ON</td> <td>ON</td> <td>ON</td> </tr> </tbody> </table>	Switch Address	1	2	3	4	5	0	OFF	OFF	OFF	OFF	OFF	1	ON	OFF	OFF	OFF	OFF	2	OFF	ON	OFF	OFF	OFF	3	ON	ON	OFF	OFF	OFF	:	:	:	:	:	:	28	OFF	OFF	ON	ON	ON	29	ON	OFF	ON	ON	ON	30	OFF	ON	ON	ON	ON	31	ON	ON	ON	ON	ON	Station Address: 1 Optional Selection: Selection for Communication Operation (Start from LSB)
Switch Address	1	2	3	4	5																																																									
0	OFF	OFF	OFF	OFF	OFF																																																									
1	ON	OFF	OFF	OFF	OFF																																																									
2	OFF	ON	OFF	OFF	OFF																																																									
3	ON	ON	OFF	OFF	OFF																																																									
:	:	:	:	:	:																																																									
28	OFF	OFF	ON	ON	ON																																																									
29	ON	OFF	ON	ON	ON																																																									
30	OFF	ON	ON	ON	ON																																																									
31	ON	ON	ON	ON	ON																																																									
6	<table border="1"> <thead> <tr> <th>Contents</th> <th>LSB</th> <th>MSB</th> </tr> </thead> <tbody> <tr> <td>Selection for Communication Operation (Start from LSB)</td> <td><u>ON</u></td> <td>OFF</td> </tr> <tr> <td>Selection for Communication Operation (Start from MSB)</td> <td>OFF</td> <td><u>ON</u></td> </tr> </tbody> </table>	Contents	LSB	MSB	Selection for Communication Operation (Start from LSB)	<u>ON</u>	OFF	Selection for Communication Operation (Start from MSB)	OFF	<u>ON</u>																																																				
Contents	LSB	MSB																																																												
Selection for Communication Operation (Start from LSB)	<u>ON</u>	OFF																																																												
Selection for Communication Operation (Start from MSB)	OFF	<u>ON</u>																																																												

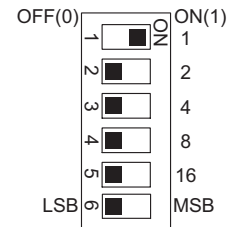

*1 For connection to a TS, be sure to set the station address other than 0.

Communication setting

Set communication parameters.

Be sure to match the settings to those made on the [Communication Setting] tab window of the editor.

(Underlined setting: default)

Function Code	Item	Setting	Example
F16	Baud rate	4: 4800 bps 5: <u>9600 bps</u> 6: 19200 bps	5
F17	Data length	0: 7 bit 1: <u>8 bits</u>	1
F18	Parity bit	0: None 1: <u>Even</u> 2: Odd	1
F19	Stop bit	0: 1 bit 1: <u>2 bits</u>	1

Available Memory

The available memory setting range varies depending on the device. Be sure to set within the range available with the device to be used. Use [TYPE] when assigning the indirect memory for macro programs.

Memory	TYPE	Remarks
---	00H	

15.2.21 HFR-C11K

Communication Setting

Editor

Communication setting

(Underlined setting: default)

Item	Setting	Remarks
Connection Mode	1 : 1 / <u>1:n</u> / Multi-link2	
Signal Level	<u>RS-422/485</u>	
Baud Rate	4800 / <u>9600</u> / 19200 bps	
Data Length	<u>7</u> / 8 bits	
Stop Bit	<u>1</u> / 2 bits	
Parity	None / Odd / <u>Even</u>	
Target Port No.	<u>1</u> to 31	

IH Inverter

Be sure to match the settings to those made on the [Communication Setting] tab window of the editor. (Underlined setting: default)

SW3 setting (Station address / Terminating resistance)

Switch	Contents	Example:																																																												
1	<table border="1"> <thead> <tr> <th>Switch Address</th> <th>1</th> <th>2</th> <th>3</th> <th>4</th> <th>5</th> </tr> </thead> <tbody> <tr> <td>0</td> <td>OFF</td> <td>OFF</td> <td>OFF</td> <td>OFF</td> <td>OFF</td> </tr> <tr> <td>1</td> <td>ON</td> <td>OFF</td> <td>OFF</td> <td>OFF</td> <td>OFF</td> </tr> <tr> <td>2</td> <td>OFF</td> <td>ON</td> <td>OFF</td> <td>OFF</td> <td>OFF</td> </tr> <tr> <td>3</td> <td>ON</td> <td>ON</td> <td>OFF</td> <td>OFF</td> <td>OFF</td> </tr> <tr> <td>:</td> <td>:</td> <td>:</td> <td>:</td> <td>:</td> <td>:</td> </tr> <tr> <td>28</td> <td>OFF</td> <td>OFF</td> <td>ON</td> <td>ON</td> <td>ON</td> </tr> <tr> <td>29</td> <td>ON</td> <td>OFF</td> <td>ON</td> <td>ON</td> <td>ON</td> </tr> <tr> <td>30</td> <td>OFF</td> <td>ON</td> <td>ON</td> <td>ON</td> <td>ON</td> </tr> <tr> <td>31</td> <td>ON</td> <td>ON</td> <td>ON</td> <td>ON</td> <td>ON</td> </tr> </tbody> </table>	Switch Address	1	2	3	4	5	0	OFF	OFF	OFF	OFF	OFF	1	ON	OFF	OFF	OFF	OFF	2	OFF	ON	OFF	OFF	OFF	3	ON	ON	OFF	OFF	OFF	:	:	:	:	:	:	28	OFF	OFF	ON	ON	ON	29	ON	OFF	ON	ON	ON	30	OFF	ON	ON	ON	ON	31	ON	ON	ON	ON	ON	Station Address: 1 Terminating Resistance: None
Switch Address		1	2	3	4	5																																																								
0		OFF	OFF	OFF	OFF	OFF																																																								
1		ON	OFF	OFF	OFF	OFF																																																								
2		OFF	ON	OFF	OFF	OFF																																																								
3	ON	ON	OFF	OFF	OFF																																																									
:	:	:	:	:	:																																																									
28	OFF	OFF	ON	ON	ON																																																									
29	ON	OFF	ON	ON	ON																																																									
30	OFF	ON	ON	ON	ON																																																									
31	ON	ON	ON	ON	ON																																																									
2	Station Address *1																																																													
3																																																														
4																																																														
5																																																														
6	Terminating Resistance	<table border="1"> <thead> <tr> <th>Contents</th> <th>OFF</th> <th>ON</th> </tr> </thead> <tbody> <tr> <td>Terminating resistance</td> <td><u>None</u></td> <td>Provided</td> </tr> </tbody> </table>	Contents	OFF	ON	Terminating resistance	<u>None</u>	Provided																																																						
Contents	OFF	ON																																																												
Terminating resistance	<u>None</u>	Provided																																																												

*1 For connection to a TS, be sure to set the station address other than 0.

Communication setting

Set communication parameters.

Be sure to match the settings to those made on the [Communication Setting] tab window of the editor.

(Underlined setting: default)

Function Code	Item	Setting	Example
r 04	Baud rate	2: 4800 bps <u>3: 9600 bps</u> 4: 19200 bps	3
r 05	Data length	0: 8 bit <u>1: 7 bits</u>	1
r 06	Parity bit	0: None <u>1: Even</u> 2: Odd	1
r 07	Stop bit	0: 2 bit <u>1: 1 bits</u>	1
r 10	Communication protocol*	<u>0: FGI-bus</u> 1: C9K mode	0

* RS-485 communication is available when the communication is enabled by digital input.

Example: To make the communication enabled when digital input terminal X1 is turned ON;

Set "11 (RS485 communication selection (RS))" for function code i01 and turn on the digital input terminal X1 externally. Terminals from X2 to X5 can also be used. Set the function code corresponding to the digital input terminal to use.

Available Memory

The available memory setting range varies depending on the device. Be sure to set within the range available with the device to be used. Use [TYPE] when assigning the indirect memory for macro programs.

Memory	TYPE	Remarks
S (command data)	00H	
M (monitor data)	01H	
F (basic function)	02H	
E (error display function)	03H	
C (control function)	04H	
P (optional function)	05H	
H (high level function)	06H	
o (output terminal function)	08H	
i (input terminal function)	0BH	
t (control function in the event of trip (alarm) occurrence)	0CH	
r (RS communication function)	0DH	
Pn (touch panel function)	0EH	

PLC_CTL

Content	F0	F1 (= \$u n)		F2
Reset command	1 - 8 (PLC1 - 8)	n	Station number	2
		n + 1	Command: 0	

15.2.22 PPMC (MODBUS RTU)

Communication Setting

Editor

Communication setting

(Underlined setting: default)

Item	Setting	Remarks
Connection Mode	1 : 1 / 1 : n / Multi-link2	
Signal Level	<u>RS-232C</u> / RS-422/485	
Baud Rate	<u>9600</u> / 19200 bps	
Data Length	8 bits	Do not change the default setting because the setting on the AC power monitor cannot be changed.
Stop Bit	1 bit	
Parity	<u>None</u> / Even / Odd	
Target Port No.	1 to 31	

AC Power Monitor

The communication parameters can be set using keys attached to the front of the AC power monitor. Be sure to match the settings to those made on the [Communication Setting] tab window of the editor.

(Underlined setting: default)

Parameter	Item	Setting	Example
Setting condition 2	Item number 2	ID number	1 to 31 (default: unit number ^{*1})
	Item number 3	Communication protocol selection	<u>nor: Dedicated protocol</u> rtu: Modbus RTU protocol ^{*2}
	Item number 7	Baud rate	<u>9.6: 9600 bps</u> 19.2: 19200 bps 4.8: 4800 bps
	Item number 8	Data length, parity	<u>8n: Data length 8 bits, without parity</u> 8o: Data length 8 bits, odd parity 8E: Data length 8 bits, even parity

*1 The unit number is set for the ID number upon delivery. The unit number is indicated on the instruction plate attached to the side of the case.

*2 Select "rtu (Modbus RTU)" for the communication protocol when communicating with the TS.

*3 The communication parameter (stop bit) is fixed to 1 bit.

*4 The communication function of the AC power monitor can be selected at the time of purchase. Select a model on which RS-485/RS-232C communication is available.

Available Memory

The available memory setting range varies depending on the device. Be sure to set within the range available with the device to be used. Use [TYPE] when assigning the indirect memory for macro programs.

Memory	TYPE	Remarks
4 (holding register)	02H	
3 (input register)	03H	Read only

* Remarks on data format for the following memory:

40022 (fixed voltage), 40028 (Ip fixed power factor): 6-byte character string

40046 (calendar): 14-byte character string

Measurement data: real type (Float)

40060 (alarm clear), 40062 (amount of power clear), 40064 (cumulative value of invalid power clear): write only

15.2.23 FALDIC- α Series

Communication Setting

Editor

Communication setting

(Underlined setting: default)

Item	Setting	Remarks
Connection Mode	1 : 1 / <u>1:n</u> / Multi-link2	
Signal Level	RS-422/485	Do not change the default setting other than baud rate because the setting on the servo amplifier cannot be changed.
Baud Rate	<u>9600</u> / 19200 / 38400 bps	
Data Length	8 bits	
Stop Bit	1 bit	
Parity	Even	
Target Port No.	1 to 31	

Servo Amplifier

Set the communication parameters using the touch panel mounted on the servo amplifier.

Be sure to match the settings to those made on the [Communication Setting] tab window of the editor.

(Underlined setting: default)

Parameter	Item	Setting	Example
<i>Pn002</i> System parameter	<i>PP096</i> (No. 96)	Station number	<u>1</u> to 31 1
	<i>PP097</i> (No. 97)	Baud rate	<u>0</u> : 9600 bps 1: 19200 bps 2: 38400 bps 0

*1 The communication function of the servo amplifier can be selected at the time of purchase. Select a model on which host interface: universal communication (RS-485) is available.

*2 The following communication parameters are fixed; data length: 8 bits, stop bit: 1 bit, and parity: even.

Available Memory

The available memory setting range varies depending on the device. Be sure to set within the range available with the device to be used. Use [TYPE] when assigning the indirect memory for macro programs.

Memory	TYPE	Remarks
00 (monitor data)	00H	Double-word, read only
01 (data on positioning being executed)	01H	Double-word, read only
10 (sequence mode)	02H	Read only
11 (control input/output signal)	03H	Read only
12 (alarm detection log)	04H	Read only
13 (detected alarm contents)	05H	Read only
20 (standard parameter)	06H	Double-word ^{*1}
21 (system parameter)	07H	Double-word ^{*1}
30 (positioning data)	08H	Double-word ^{*2}
40 (control command)	09H	Double-word, write only

*1 Input a parameter number by manual operation.

*2 Address denotations XXYY

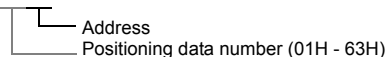

PLC_CTL

Contents	F0	F1 (= \$u n)		F2
Positioning data (immediate) setting	1 - 8 (PLC1 - 8)	n	Station number	6
		n + 1	Command: 9	
		n + 2	ABS/INC	
		n + 3	Speed selection	
		n + 4 to n + 5	Position data	
Automatic start (immediate)	1 - 8 (PLC1 - 8)	n	Station number	6
		n + 1	Command: 11	
		n + 2	ABS/INC	
		n + 3	Speed selection	
		n + 4 to n + 5	Position data	
Automatic start (positioning data number)	1 - 8 (PLC1 - 8)	n	Station number	3
		n + 1	Command: 12	
		n + 2	Start number	
Override setting	1 - 8 (PLC1 - 8)	n	Station number	4
		n + 1	Command: 33	
		n + 2	Data type	
		n + 3	Setting	

15.2.24 FALDIC-W Series

Communication Setting

Editor

Communication setting

(Underlined setting: default)

Item	Setting	Remarks
Connection Mode	1 : 1 / <u>1:n</u> / Multi-link2 / Multi-link2 (Ethernet) / 1 : n Multi-link2 (Ethernet)	
Signal Level	RS-422/485	Do not change the default setting other than baud rate because the setting on the servo amplifier cannot be changed.
Baud Rate	9600 / 19200 / <u>38400</u> bps	
Data Length	8 bits	
Stop Bit	1 bit	
Parity	Even	
Target Port No.	1 to 31	

* When changing the time-out time, note the following points. (Default: 500 (msec))

- When the baud rate is 19200 bps or 38400 bps, set 200 (msec) or greater.
- When the baud rate is 9600 bps, set 500 (msec) or greater.

Servo Amplifier

Set the communication parameters using the touch panel mounted on the servo amplifier.

Be sure to match the settings to those made on the [Communication Setting] tab window of the editor.

(Underlined setting: default)

Parameter	Item	Setting	Example	Remarks	
Pn01 Parameter editing mode	no. <u>82</u> (No. 82)	Station number	1 to 31	1	The setting takes effect when the power is turned off and back on again.
	no. <u>83</u> (No. 83)	Baud rate	<u>0: 38400 bps</u> 1: 19200 bps 2: 9600 bps	0	

* The following communication parameters are fixed; data length: 8 bits, stop bit: 1 bit, and parity: even.

Available Memory

The available memory setting range varies depending on the device. Be sure to set within the range available with the device to be used. Use [TYPE] when assigning the indirect memory for macro programs.

Memory	TYPE	Remarks
01 (monitor data)	00H	Double-word, read only
02 (sequence mode)	01H	Read only
03 (sequence I/O signal)	02H	Read only
04 (alarm history)	03H	Read only
06 (current alarm readout)	04H	Read only
07 (parameter)	05H	Double-word
09 (alarm reset)	06H	Write only

Indirect Memory Designation

	15	8 7	0
n + 0	Model		Memory type
n + 1	Address No.		
n + 2	Expansion code *		Bit designation
n + 3	00		Station number

* In the expansion code, set which word, higher or lower, is to be read when a double-word address is specified (expansion bit designation).

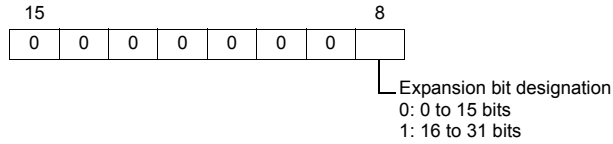

PLC_CTL

Contents	F0	F1 (= \$u n)		F2
System status readout	1 - 8 (PLC1 - 8)	n	Station number	2
		n + 1	Command: 0	
		n + 2	System 1	
		n + 3	System 2	
		n + 4	Model	
		n + 5	Occupied by maker, Zno	
		n + 6 - n + 10	Occupied by maker (max. 10 bytes)	

Return data: Data stored from the servo amplifier to the TS

15.2.25 PH Series

Communication Setting

Editor

Communication setting

(Underlined setting: default)

Item	Setting	Remarks
Connection Mode	1 : 1 / <u>1:n</u> / Multi-link2 / Multi-link2 (Ethernet) / 1 : n Multi-link2 (Ethernet)	
Signal Level	RS-422/485	
Baud Rate	4800 / 9600 / <u>19200</u> bps	
Data Length	8 bits	Do not change the default setting because the setting on the recorder cannot be changed.
Stop Bit	<u>1</u> / 2 bits	
Parity	None / <u>Odd</u> / Even	
Target Port No.	<u>1</u> to 31	

Recorder

The communication parameters can be set using keys attached to the front of the recorder.

Be sure to match the settings to those made on the [Communication Setting] tab window of the editor.

(Underlined setting: default)

Parameter	Setting	Example	Remarks
Station No.	<u>1</u> to 31	1	
Baud rate	4800 / 9600 / <u>19200</u> bps	19200 bps	
Stop bit	<u>1</u> / 2 bits	1	
Parity	None / Even / <u>Odd</u>	Odd	

- * The communication function of the recorder can be selected at the time of purchase. Select a model on which RS-485 transmission mode is available.
- * The communication parameter (data length) is fixed to 8 bits.

Available Memory

The available memory setting range varies depending on the device. Be sure to set within the range available with the device to be used. Use [TYPE] when assigning the indirect memory for macro programs.

Memory	TYPE	Remarks
F00 (setting value file)	00H	
F01 (range file CH1)	01H	
F02 (range file CH2)	02H	
F03 (range file CH3)	03H	
F04 (range file CH4)	04H	
F05 (range file CH5)	05H	
F06 (range file CH6)	06H	
F07 (range file CH7)	07H	
F08 (range file CH8)	08H	
F09 (range file CH9)	09H	
F10 (range file CH10)	0AH	
F11 (range file CH11)	0BH	
F12 (range file CH12)	0CH	
F13 (warning setting file)	0DH	
F14 (system file)	0EH	
F15 (command file)	0FH	
F16 (abnormal input information file)	10H	Read only
F17 (input data file)	11H	Read only
F19 (alarm output file)	13H	Read only
F21 (transmission input data file)	15H	Write only
F22 (message file)	16H	
F33 (daily report file 1)	21H	Read only
F34 (daily report file 2)	22H	Read only
F35 (daily report file 3)	23H	Read only
F37 (integral file 1)	25H	Read only
F38 (integral file 2)	26H	Read only
F51 (status information control file)	33H	

15.2.26 PHR (MODBUS RTU)

Communication Setting

Editor

Communication setting

(Underlined setting: default)

Item	Setting	Remarks
Connection Mode	1 : 1 / <u>1:n</u> / Multi-link2	
Signal Level	RS-422/485	Do not change the default settings of the signal level, data length and stop bit because these settings on the recorder cannot be changed.
Baud Rate	9600 / <u>19200</u> bps	
Data Length	8 bits	
Stop Bit	1 bit	
Parity	None / Even / <u>Odd</u>	
Target Port No.	<u>1</u> to 31	

Recorder

The communication parameters can be set using keys attached to the front of the recorder.

Be sure to match the settings to those made on the [Communication Setting] tab window of the editor.

(Underlined setting: default)

Parameter	Setting	Example	Remarks
Modbus station No.	<u>1</u> to 31	1	
Modbus baud rate	9600 / <u>19200</u> bps	19200 bps	
Modbus parity	None / Even / <u>Odd</u>	Odd	
Front communication function	<u>ON</u> / OFF	ON	Be sure to set to "ON".

*1 The communication function of the recorder can be selected at the time of purchase. Select a model on which RS-485 communication is available.

*2 The following communication parameters are fixed; data length: 8 bits and stop bit: 1 bit.

Available Memory

The available memory setting range varies depending on the device. Be sure to set within the range available with the device to be used. Use [TYPE] when assigning the indirect memory for macro programs.

Memory	TYPE	Remarks
4 (holding register)	02H	
3 (input register)	03H	

15.2.27 WA5000

Communication Setting

Editor

Communication setting

(Underlined setting: default)

Item	Setting	Remarks
Connection Mode	1 : 1 / <u>1:n</u> / Multi-link2	
Signal Level	<u>RS-232C</u> / RS-422/485	
Baud Rate	4800 / <u>9600</u> / 19200 / 38400 bps	
Data Length	<u>7</u> / 8 bits	
Stop Bit	1 / <u>2</u> bits	
Parity	None / <u>Even</u> / Odd	
CR / LF	<u>CR</u> / CR/LF	
Target Port No.	<u>1</u> to 31	
Send Delay Time	0 to 255 msec	*1

*1 If the send delay time is too short, "Communication Error "Format"" may occur. If this error occurs, set the send delay time to 5 msec or longer.

Digital Panel Meter

The communication parameters can be set using keys attached to the front of the digital panel meter. Be sure to match the settings to those made on the [Communication Setting] tab window of the editor.

(Underlined setting: default)

Parameter	Item	Setting	Example	Remarks
BAUD	BAUD	Baud rate setting	4800: 4800 <u>9600: 9600</u> 192: 19200 384: 38400	9600
DATA	DATA	Data length setting	<u>7: 7 bits</u> 8: 8 bits	7 bits
P.BIT	P.BIT	Parity bit setting	<u>E: Even</u> o: Odd n: None	E: Even
S.BIT	S.BIT	Stop bit setting	<u>2: 2 bits</u> 1: 1 bit	2: 2 bits
T-	T-	Delimiter setting	<u>cr.LF: CR/LF</u> cr: CR	cr.LF: CR/LF
ADR	ADR	Unit ID setting	01 to 31 (default: <u>00</u>)	01 Specify a value when using RS-485 connection.

* The communication function of the temperature controller can be selected with the output unit specified at the time of purchase. Select a model on which RS-485/RS-232C communication is available.

Available Memory

The available memory setting range varies depending on the device. Be sure to set within the range available with the device to be used. Use [TYPE] when assigning the indirect memory for macro programs.

Memory	TYPE	Remarks
DSP (display)	00H	
CMP (comparator)	01H	
SCL (scaling)	02H	
CAL1 (calibration 1) ^{*1}	03H	
CAL2 (calibration 2)	04H	

*1 To perform zero calibration (0000), specify a value other than 0.

PLC_CTL

Contents	F0	F1 (= \$u n)		F2
Hold remote control response	1 - 8 (PLC1 - 8)	n	Station number	2
		n + 1	Command: 0	
		n + 2	Hold status 0: OFF, 1: ON	
Hold terminal response	1 - 8 (PLC1 - 8)	n	Station number	2
		n + 1	Command: 1	
		n + 2	Hold status 0: OFF, 1: ON	
Hold remote control	1 - 8 (PLC1 - 8)	n	Station number	3
		n + 1	Command: 2	
		n + 2	Hold status 0: OFF, 1: ON	
Trigger input	1 - 8 (PLC1 - 8)	n	Station number	2
		n + 1	Command: 3	
		n + 2	Display type 0: Normal display 1: Over display 2: Peak hold display 3: Valley hold display 4: Peak valley hold display	
		n + 3	Measurement value	
		n + 4	Comparison result 0: OFF 1: HI 2: GO 3: LO	
Hold remote control cancel	1 - 8 (PLC1 - 8)	n	Station number	2
		n + 1	Command: 4	
Peak hold remote control response	1 - 8 (PLC1 - 8)	n	Station number	2
		n + 1	Command: 5	
		n + 2	Peak hold type 0: Peak hold 1: Valley hold 2: Peak valley hold	
		n + 3	Peak hold status 0: OFF, 1: ON	
Peak hold terminal response	1 - 8 (PLC1 - 8)	n	Station number	2
		n + 1	Command: 6	
		n + 2	Peak hold status 0: OFF, 1: ON	
Peak hold type setting	1 - 8 (PLC1 - 8)	n	Station number	3
		n + 1	Command: 7	
		n + 2	Peak hold type 0: Peak hold 1: Valley hold 2: Peak valley hold	
Peak hold remote control	1 - 8 (PLC1 - 8)	n	Station number	3
		n + 1	Command: 8	
		n + 2	Peak hold remote 0: OFF, 1: ON	
Peak hold value response	1 - 8 (PLC1 - 8)	n	Station number	2
		n + 1	Command: 9	
		n + 2	Peak hold value	
		n + 3	Valley hold value	
Peak hold value clear	1 - 8 (PLC1 - 8)	n	Station number	3
		n + 1	Command: 10	
		n + 2	Peak hold type 0: Peak hold 1: Valley hold 2: Peak valley hold	
		n + 4	Peak valley hold value	
Peak hold remote control cancel	1 - 8 (PLC1 - 8)	n	Station number	2
		n + 1	Command: 11	

Contents	F0	F1 (= \$u n)		F2
Digital zero remote control response	1 - 8 (PLC1 - 8)	n	Station number	2
		n + 1	Command: 12	
		n + 2	Digital zero 0: OFF, 1: ON	
		n + 3	Displayed value	
Digital zero terminal response	1 - 8 (PLC1 - 8)	n	Station number	2
		n + 1	Command: 13	
		n + 2	Digital zero 0: OFF, 1: ON	
Digital zero remote control	1 - 8 (PLC1 - 8)	n	Station number	4
		n + 1	Command: 14	
		n + 2	Digital zero 0: OFF, 1: ON, 2: ON when the value reaches the set value	
		n + 3	Setting value	
Digital zero remote control cancel	1 - 8 (PLC1 - 8)	n	Station number	2
		n + 1	Command: 15	
Comparison output remote control response	1 - 8 (PLC1 - 8)	n	Station number	2
		n + 1	Command: 16	
		n + 2	Status 0: OFF 1: Set (ON) HI 2: Set (ON) GO 3: Set (ON) LO	
Comparison output remote control	1 - 8 (PLC1 - 8)	n	Station number	3
		n + 1	Command: 17	
		n + 2	Status 0: OFF 1: Set (ON) HI 2: Set (ON) GO 3: Set (ON) LO	
Comparison output remote control cancel	1 - 8 (PLC1 - 8)	n	Station number	2
		n + 1	Command: 18	
Remote control response	1 - 8 (PLC1 - 8)	n	Station number	2
		n + 1	Command: 19	
		n + 2	Remote control status <div style="display: flex; align-items: center;"> <div style="margin-right: 10px;">Bit</div> <div style="display: flex; gap: 5px;"> <div style="border: 1px solid black; padding: 2px;">-</div> <div style="border: 1px solid black; padding: 2px;">3</div> <div style="border: 1px solid black; padding: 2px;">2</div> <div style="border: 1px solid black; padding: 2px;">1</div> <div style="border: 1px solid black; padding: 2px;">0</div> </div> <div style="margin-left: 20px; margin-top: 5px;"> <p>— Hold function</p> <p>— Peak hold</p> <p>— Digital zero</p> <p>— Comparison output</p> </div> </div> <p>* No remote control is performed when all bits are reset (OFF).</p>	
Maximum / minimum / (maximum - minimum) response	1 - 8 (PLC1 - 8)	n	Station number	2
		n + 1	Command: 20	
		n + 2	Maximum	
		n + 3	Minimum	
		n + 4	(Maximum - minimum)	
Maximum / minimum / (maximum - minimum) clear	1 - 8 (PLC1 - 8)	n	Station number	3
		n + 1	Command: 21	
		n + 2	Maximum / minimum / (maximum - minimum) clear 0: Maximum 1: Minimum 2: Maximum - minimum	

Contents	F0	F1 (= \$u n)		F2
Range response	1 - 8 (PLC1 - 8)	n	Station number	2
		n + 1	Command: 22	
		n + 2	Range 0: No designation 12: J 1: Range 11 13: T 2: Range 12 14: R 3: Range 13 15: S 4: Range 14 16: B 5: Range 15 17: PA 6: Range 23 18: Pb 7: Range 24 19: JPA 8: Range 25 20: JPb 9: Range 26 21: 1V 10: KA 22: 2A 11: KB	
Range setting	1 - 8 (PLC1 - 8)	n	Station number	3
		n + 1	Command: 23	
		n + 2	Range 1: Range 11 12: J 2: Range 12 13: T 3: Range 13 14: R 4: Range 14 15: S 5: Range 15 16: B 6: Range 23 17: PA 7: Range 24 18: Pb 8: Range 25 19: JPA 9: Range 26 20: JPb 10: KA 21: 1V 11: KB 22: 2A	
Average number of responses	1 - 8 (PLC1 - 8)	n	Station number	2
		n + 1	Command: 24	
		n + 2	Average number of times 1 / 2 / 4 / 8 / 10 / 20 / 40 / 80 (times)	
Setting for average number of times	1 - 8 (PLC1 - 8)	n	Station number	3
		n + 1	Command: 25	
		n + 2	Average number of times 1 / 2 / 4 / 8 / 10 / 20 / 40 / 80 (times)	
Average number of movement times	1 - 8 (PLC1 - 8)	n	Station number	2
		n + 1	Command: 26	
		n + 2	Average number of movement times 0 (OFF) / 2 / 4 / 8 / 16 / 32 (times)	
Setting for average number of movement times	1 - 8 (PLC1 - 8)	n	Station number	3
		n + 1	Command: 27	
		n + 2	Average number of movement times 0 (OFF) / 2 / 4 / 8 / 16 / 32 (times)	
Step-wide response	1 - 8 (PLC1 - 8)	n	Station number	2
		n + 1	Command: 28	
		n + 2	Step wide 1:1, 2:2, 5:5, 0:10 (digit)	
Step-wide setting	1 - 8 (PLC1 - 8)	n	Station number	3
		n + 1	Command: 29	
		n + 2	Step wide 1:1, 2:2, 5:5, 0:10 (digit)	
Communication function parameter response	1 - 8 (PLC1 - 8)	n	Station number	2
		n + 1	Command: 30	
		n + 2	Baud rate 0: 2400, 1: 4800, 2: 9600, 3: 19200, 4: 38400	
		n + 3	Data length 0: 7 bits, 1: 8 bits	
		n + 4	Parity 0: none, 1: odd, 2: even	
		n + 5	Stop bit 0: 1 bit, 1: 2 bits	
n + 6	Delimiter 0: CR/LF, 1: CR			

Contents	F0	F1 (= \$u n)		F2
Communication function parameter setting	1 - 8 (PLC1 - 8)	n	Station number	7
		n + 1	Command: 31	
		n + 2	Baud rate 0: 2400, 1: 4800, 2: 9600, 3: 19200, 4: 38400	
		n + 3	Data length 0: 7 bits, 1: 8 bits	
		n + 4	Parity 0: none, 1: odd, 2: even	
		n + 5	Stop bit 0: 1 bit, 1: 2 bits	
		n + 6	Delimiter 0: CR/LF, 1: CR	
Unit ID response	1 - 8 (PLC1 - 8)	n	Station number	2
		n + 1	Command: 32	
		n + 2	Unit ID 1 to 99	
Unit ID setting	1 - 8 (PLC1 - 8)	n	Station number	3
		n + 1	Command: 33	
		n + 2	Unit ID 1 to 99	
Analog output type response	1 - 8 (PLC1 - 8)	n	Station number	2
		n + 1	Command: 34	
		n + 2	Analog output type 0: Not provided 1: OFF 2: 0 - 1 (V) 3: 0 - 10 (V) 4: 1 - 5 (V) 5: 0 - 20 (mA) 6: 4 - 20 (mA)	
Analog output type setting	1 - 8 (PLC1 - 8)	n	Station number	3
		n + 1	Command: 35	
		n + 2	Analog output type 1: OFF 2: 0 - 1 (V) 3: 0 - 10 (V) 4: 1 - 5 (V) 5: 0 - 20 (mA) 6: 4 - 20 (mA)	
Digital zero backup status response	1 - 8 (PLC1 - 8)	n	Station number	2
		n + 1	Command: 36	
		n + 2	Digital zero backup status 0: OFF 1: ON	
Digital zero backup control	1 - 8 (PLC1 - 8)	n	Station number	3
		n + 1	Command: 37	
		n + 2	Digital zero backup status 0: OFF 1: ON	
Digital zero data save command	1 - 8 (PLC1 - 8)	n	Station number	2
		n + 1	Command: 38	
Input change response	1 - 8 (PLC1 - 8)	n	Station number	2
		n + 1	Command: 39	
		n + 2	Input change 0: Not provided 1: Open collector 2: Logic 3: Magnetic	
Input change setting	1 - 8 (PLC1 - 8)	n	Station number	3
		n + 1	Command: 40	
		n + 2	Input change 1: Open collector 2: Logic 3: Magnetic	

Contents	F0	F1 (= \$u n)		F2
Tracking zero response	1 - 8 (PLC1 - 8)	n	Station number	2
		n + 1	Command: 41	
		n + 2	Tracking zero time 0 (OFF) / 1 to 99	
		n + 3	Tracking zero width 0 (OFF) / 1 to 99	
Tracking zero time setting	1 - 8 (PLC1 - 8)	n	Station number	3
		n + 1	Command: 42	
		n + 2	Tracking zero time 0 (OFF) / 1 to 99	
Tracking zero width setting	1 - 8 (PLC1 - 8)	n	Station number	3
		n + 1	Command: 43	
		n + 2	Tracking zero width 0 (OFF) / 1 to 99	
Sensor power response	1 - 8 (PLC1 - 8)	n	Station number	2
		n + 1	Command: 44	
		n + 2	Sensor power 0: 5 V 1: 10 V	
Sensor power setting	1 - 8 (PLC1 - 8)	n	Station number	3
		n + 1	Command: 45	
		n + 2	Sensor power 0: 5 V 1: 10 V	
Power-on delay time response	1 - 8 (PLC1 - 8)	n	Station number	2
		n + 1	Command: 46	
		n + 2	Power-on delay time 0 (OFF) / 1 to 30	
Power-on delay time setting	1 - 8 (PLC1 - 8)	n	Station number	3
		n + 1	Command: 47	
		n + 2	Power-on delay time 0 (OFF) / 1 to 30	
Protection response	1 - 8 (PLC1 - 8)	n	Station number	2
		n + 1	Command: 48	
		n + 2	Protect 0: OFF 1: ON	
Protection setting	1 - 8 (PLC1 - 8)	n	Station number	3
		n + 1	Command: 49	
		n + 2	Protect 0: OFF 1: ON	
Unit No. response	1 - 8 (PLC1 - 8)	n	Station number	2
		n + 1	Command: 50	
		n + 2	Input unit number 1 to 18	
		n + 3	Output unit number 0 to 7	
Response to prohibition of key operations	1 - 8 (PLC1 - 8)	n	Station number	2
		n + 1	Command: 51	
		n + 2	Prohibition of key operations 0: OFF 1: ON	
Prohibition of key operations setting	1 - 8 (PLC1 - 8)	n	Station number	3
		n + 1	Command: 52	
		n + 2	Prohibition of key operations 0: OFF 1: ON	
Response to linearizing function status	1 - 8 (PLC1 - 8)	n	Station number	2
		n + 1	Command: 53	
		n + 2	Linearizing function 0: OFF 1: ON 2: CLR	

Contents	F0	F1 (= \$u n)		F2
Linearizing function status setting	1 - 8 (PLC1 - 8)	n	Station number	3
		n + 1	Command: 54	
		n + 2	Linearizing function 0: OFF 1: ON 2: CLR	
Response to the number of linearization correction data	1 - 8 (PLC1 - 8)	n	Station number	2
		n + 1	Command: 55	
		n + 2	Linearization correction data 0 (clear) to 16	
The number of linearization correction data setting	1 - 8 (PLC1 - 8)	n	Station number	3
		n + 1	Command: 56	
		n + 2	Linearization correction data 1 to 16	
Response to linearization data	1 - 8 (PLC1 - 8)	n	Station number	4
		n + 1	Command: 57	
		n + 2	Read start number 1 to 16	
		n + 3	The number of read data 1 to 16	
		n + 4	Linearization data input value (start number + 0)	
		n + 5	Linearization data output value (start number + 0)	
		n + 6	Linearization data input value (start number + 1)	
		n + 7	Linearization data output value (start number + 1)	
		n + 8	Linearization data input value (start number + 2)	
		n + 9	Linearization data output value (start number + 2)	
		n + 10	Linearization data input value (start number + 3)	
		n + 11	Linearization data output value (start number + 3)	
		n + 12	Linearization data input value (start number + 4)	
		n + 13	Linearization data output value (start number + 4)	
		n + 14	Linearization data input value (start number + 5)	
		n + 15	Linearization data output value (start number + 5)	
		n + 16	Linearization data input value (start number + 6)	
		n + 17	Linearization data output value (start number + 6)	
		n + 18	Linearization data input value (start number + 7)	
		n + 19	Linearization data output value (start number + 7)	
		n + 20	Linearization data input value (start number + 8)	
		n + 21	Linearization data output value (start number + 8)	
		n + 22	Linearization data input value (start number + 9)	
		n + 23	Linearization data output value (start number + 9)	
		n + 24	Linearization data input value (start number + 10)	
		n + 25	Linearization data output value (start number + 10)	
		n + 26	Linearization data input value (start number + 11)	
		n + 27	Linearization data output value (start number + 11)	
		n + 28	Linearization data input value (start number + 12)	
		n + 29	Linearization data output value (start number + 12)	
		n + 30	Linearization data input value (start number + 13)	
		n + 31	Linearization data output value (start number + 13)	
		n + 32	Linearization data input value (start number + 14)	
		n + 33	Linearization data output value (start number + 14)	
		n + 34	Linearization data input value (start number + 15)	4
n + 35	Linearization data output value (start number + 15)			

Contents	F0	F1 (= \$u n)		F2
Linearization data setting	1 - 8 (PLC1 - 8)	n	Station number	6 , 36
		n + 1	Command: 58	
		n + 2	Read start number 1 to 16	
		n + 3	The number of read data 1 to 16	
		n + 4	Linearization data input value (start number + 0)	
		n + 5	Linearization data output value (start number + 0)	
		n + 6	Linearization data input value (start number + 1)	
		n + 7	Linearization data output value (start number + 1)	
		n + 8	Linearization data input value (start number + 2)	
		n + 9	Linearization data output value (start number + 2)	
		n + 10	Linearization data input value (start number + 3)	
		n + 11	Linearization data output value (start number + 3)	
		n + 12	Linearization data input value (start number + 4)	
		n + 13	Linearization data output value (start number + 4)	
		n + 14	Linearization data input value (start number + 5)	
		n + 15	Linearization data output value (start number + 5)	
		n + 16	Linearization data input value (start number + 6)	
		n + 17	Linearization data output value (start number + 6)	
		n + 18	Linearization data input value (start number + 7)	
		n + 19	Linearization data output value (start number + 7)	
		n + 20	Linearization data input value (start number + 8)	
		n + 21	Linearization data output value (start number + 8)	
		n + 22	Linearization data input value (start number + 9)	
		n + 23	Linearization data output value (start number + 9)	
		n + 24	Linearization data input value (start number + 10)	
		n + 25	Linearization data output value (start number + 10)	
		n + 26	Linearization data input value (start number + 11)	
		n + 27	Linearization data output value (start number + 11)	
		n + 28	Linearization data input value (start number + 12)	
		n + 29	Linearization data output value (start number + 12)	
		n + 30	Linearization data input value (start number + 13)	
		n + 31	Linearization data output value (start number + 13)	
		n + 32	Linearization data input value (start number + 14)	
		n + 33	Linearization data output value (start number + 14)	
		n + 34	Linearization data input value (start number + 15)	
n + 35	Linearization data output value (start number + 15)			

Return data: Data stored from the panel meter to the TS

15.2.28 APR-N (MODBUS RTU)

Communication Setting

Editor

Communication setting

(Underlined setting: default)

Item	Setting	Remarks
Connection Mode	1 : 1 / <u>1:n</u> / Multi-link2	
Signal Level	RS-422/485	
Baud Rate	4800 / <u>9600</u> / 19200 / 38400 bps	
Data Length	8 bits	
Stop Bit	<u>1</u> / 2 bits	
Parity	None / Even / <u>Odd</u>	
Target Port No.	<u>1</u> to 31	

AC Power Regulator

The communication parameter can be set using keys attached to the front of the AC power regulator. Be sure to match the settings to those made on the [Communication Setting] tab window of the editor.

(Underlined setting: default)

Function Code	Item	Setting	Example
6.n02	Setting device selection*	<u>APd: Setting indicator</u> nEt: Network device APr: APR main unit	nEt
7.n01	Communication protocol selection*	<u>m-S: Master / slave parallel operation</u> nEt: MODBUS RTU	nEt
7.n02	Station address	A000: 0 , A031: 31 (default: A001: 1)	A001
7.n04	Baud rate selection	4800: 4800 bps <u>9600: 9600 bps</u> 1.920: 19200 bps 3.840: 38400 bps	9600
7.n05	Parity bit + Stop bit selection	P0: Without parity, Stop bit 2 bits P1: Even parity, Stop bit 1 bits <u>P2: Odd parity, Stop bit 1 bits</u> P3: Without parity, Stop bit 1 bits	P2

*1 For communication with TS, select "Network device" for the setting device selection and "MODBUS RTU" for the communication protocol selection on this regulator.

*2 The communication parameter (data length) is fixed to 8 bits.

Available Memory

The available memory setting range varies depending on the device. Be sure to set within the range available with the device to be used. Use [TYPE] when assigning the indirect memory for macro programs.

Memory	TYPE	Remarks
---	02H	Byte address

Indirect Memory Designation

- For word designation, specify the memory No. (address) in even address.
Example: To make the memory setting of "output setting" for the function code 1.b01;
Specify "2" in the memory No. (address).
- For bit designation, it is possible to specify the memory No. (address) in both even and odd address.
Specify "00H" for the extensional code because the setting range for the bit address is 0 to 7.
Example: To make the memory setting of "gradient setting selection" for the function code 1.b09;
Specify "1" in the memory No. (address), "00H" for the extensional code, and "00" or "01" in the bit No..

15.2.29 ALPHA5 (MODBUS RTU)

Communication Setting

Editor

Communication setting

(Underlined setting: default)

Item	Setting	Remarks
Connection Mode	1 : 1 / <u>1:n</u> / Multi-link2	
Signal Level	<u>RS-422/485</u>	
Baud Rate	9600 / 19200 / <u>38400</u> bps	
Data Length	<u>8 bits</u>	
Stop Bit	<u>1</u> / 2 bits	
Parity	None / <u>Even</u> / Odd	
Target Port No.	<u>1</u> to 31	

Servo Amplifier

Set communication parameters.

Be sure to match the settings to those made on the [Communication Setting] tab window of the editor.

(Underlined setting: default)

Parameter			Item	Setting	Example
PA2 Extensional Function Setting	PA2_72	(No. 72)	Station number	<u>1</u> to 31	1
	PA2_73	(No. 73)	Baud rate	<u>0: 38400 bps</u> 1: 19200 bps 2: 9600 bps	0
	PA2_93	(No. 93)	Parity bit / Stop bit selection	<u>0: Even parity, Stop bit 1 bits</u> 1: Odd parity, Stop bit 1 bits 2: Without parity, Stop bit 1 bits 3: Even parity, Stop bit 2 bits 4: Odd parity, Stop bit 2 bits 5: Without parity, Stop bit 2 bits	0
	PA2_97	(No. 97)	Communication protocol selection*	<u>0: PC Loader protocol</u> 1: MODBUS RTU	1

*1 For communication with TS, select "MODBUS RTU" for the communication protocol selection on the servo amplifier.

*2 The communication parameter (data length) is fixed to 8 bits.

Available Memory

The available memory setting range varies depending on the device. Be sure to set within the range available with the device to be used. Use [TYPE] when assigning the indirect memory for macro programs.

Memory	TYPE	Remarks
00 (communication CONT / OUT signals)	00H	Double-word*1
01 (monitor)	01H	Double-word, read only
02 (sequence monitor)	02H	Double-word, read only
03 (various commands)	03H	Double-word
04 (parameter)	04H	Double-word
05 (immediate value data)	05H	Double-word

*1 Communication OUT signal is read only.

PLC_CTL

Contents	F0	F1 (= \$u n)		F2	
Positioning data reading	1 - 8 (PLC1 - 8)	n	Station number	4	
		n+1	Command: 03 (HEX)		
		n+2	Reading memory address		
		n+3	Reading positioning data count: m (1 to 9)		
		n+4	Positioning data m = 1		Positioning status and M code Bit 15 to 8 7 6 5 4 3 2 1 0 M code output timing Not used M code valid/invalid Step mode Command mode
		n+5			Stop timer
		n+6 to n+7			Stop position
		n+8 to n+9			Rotation speed
		n+10 to n+11			Acceleration time
		n+12 to n+13			Deceleration time
n+14 to n+(3+10m)	Positioning data (m = 2)				
Positioning data writing	1 - 8 (PLC1 - 8)	n	Station number *1	4+10m	
		n+1	Command: 10 (HEX)		
		n+2	Writing memory address		
		n+3	Writing positioning data count: m (1 to 9)		
		n+4	Positioning data m = 1		Positioning status and M code Bit 15 to 8 7 6 5 4 3 2 1 0 M code output timing Not used M code valid/invalid Step mode Command mode
		n+5			Stop timer
		n+6 to n+7			Stop position
		n+8 to n+9			Rotation speed
		n+10 to n+11			Acceleration time
		n+12 to n+13			Deceleration time
n+14 to n+(3+10m)	Positioning data (m = 2)				

*1 Select station No. 0 for broadcast commands.

Return data: Data stored from the servo amplifier to the TS

15.2.30 ALPHA5 Smart (MODBUS RTU)

Communication Setting

Editor

Communication setting

(Underlined setting: default)

Item	Setting	Remarks
Connection Mode	1 : 1 / <u>1:n</u> / Multi-link2 / Multi-link2 (Ethernet) / 1 : n Multi-link2 (Ethernet)	
Signal Level	<u>RS-422/485</u>	
Baud Rate	9600 / 19200 / <u>38400</u> / 115K bps	
Data Length	<u>8 bits</u>	
Stop Bit	<u>1</u> / 2 bits	
Parity	None / <u>Even</u> / Odd	
Target Port No.	<u>1</u> to 31	

Servo Amplifier

Set communication parameters.

Be sure to match the settings to those made on the [Communication Setting] tab window of the editor.

(Underlined setting: default)

Parameter		Item	Setting	Example
PA2 Extended function setting	PA2_72 (No. 72)	Station number	<u>1</u> to 31	1
	PA2_73 (No. 73)	Baud rate	<u>0: 38400 bps</u> 1: 19200 bps 2: 9600 bps 3: 115200 bps	0
	PA2_93 (No. 93)	Parity bit and stop bit selection	<u>0: Even parity, stop bit 1</u> 1: Odd parity, stop bit 1 2: Without parity, stop bit 1 3: Even parity, stop bit 2 4: Odd parity, stop bit 2 5: Without parity, stop bit 2	0
	PA2_97 (No. 97)	Communication protocol selection*1	<u>0: PC loader protocol</u> 1: MODBUS RTU	1

*1 For communication with a TS, select "MODBUS RTU" for the communication protocol.

*2 The communication parameter (data length) is fixed to 8 bits.

Available Memory

The available memory setting range varies depending on the device. Be sure to set within the range available with the device to be used. Use [TYPE] when assigning the indirect memory for macro programs.

Memory	TYPE	Remarks
00 (communication CONT/OUT signal)	00H	Double-word *1
01 (monitor)	01H	Double-word, read only
02 (sequence monitor)	02H	Double-word, read only
03 (various commands)	03H	Double-word
04 (parameter)	04H	Double-word
05 (immediate data)	05H	Double-word

*1 Communication OUT signal: Read only

PLC_CTL

Contents	F0	F1 (= \$u n)		F2	
Reading of positioning data	1 - 8 (PLC1 - 8)	n	Station number	4	
		n+1	Command: 03 (HEX)		
		n+2	Reading address		
		n+3	Number of positioning data to read: m (1 to 9)		
		n+4	Positioning data m = 1		Positioning status & M code Bit 15-8 7 6 5 4 3 2 1 0 M code Not used Command method Step mode Not used M code Valid/invalid M code output timing
		n+5			Stop timer
		n+6 to n+7			Stop position
		n+8 to n+9			Rotation speed
		n+10 to n+11			Acceleration time
		n+12 to n+13			Deceleration time
		n+14 to n+(3+10m)			Positioning data (m = 2)
		n+4			Positioning data m = 1
n+5	Stop timer				
n+6 to n+7	Stop position				
n+8 to n+9	Rotation speed				
n+10 to n+11	Acceleration time				
n+12 to n+13	Deceleration time				
n+14 to n+(3+10m)	Positioning data (m = 2)				

*1 Select station No. 0 for broadcast commands.

Return data: Data stored from servo amplifier to TS series

15.2.31 WE1MA (Ver. A) (MODBUS RTU)

Communication Setting

Editor

Communication setting

(Underlined setting: default)

Item	Setting	Remarks
Connection Mode	1 : 1/ <u>1</u> :n / Multi-link2 / Multi-link2 (Ethernet) / 1 : n Multi-link2 (Ethernet)	
Signal Level	RS-422/485	
Baud Rate	4800 / <u>9600</u> / 19200 / 38400 bps	
Data Length	8 bits	
Stop Bit	<u>1</u> / 2 bits	
Parity	None / <u>Even</u> / Odd	
Target Port No.	0 to 247	0: Broadcast

Electronic Multimeter

The communication parameter can be set using keys attached to the front of the electronic multimeter. Be sure to match the settings to those made on the [Communication Setting] tab window of the editor.

(Underlined setting: default)

Setting Component	Setting No.	Item	Setting	Example
Adr	231C	Station address	<u>1</u> to 247	1
bPS	232C	Baud rate	4800 / <u>9600</u> / 19200 / 38400 bps	9600
PAr	233C	Parity bit	<u>E</u> : Even o: Odd -: None	E
StoP	234C	Stop bit	<u>1</u> / 2 bits	1
WEr	235C	Protocol version	A: Version A	A

* The communication parameter (data length) is fixed to 8 bits.

Available Memory

The available memory setting range varies depending on the device. Be sure to set within the range available with the device to be used. Use [TYPE] when assigning the indirect memory for macro programs.

Memory	TYPE	Remarks
1 (input relay)	01H	Read only
4 (holding register)	02H	
3 (input register)	03H	Read only

15.2.32 WE1MA (Ver. B) (MODBUS RTU)

Communication Setting

Editor

Communication setting

(Underlined setting: default)

Item	Setting	Remarks
Connection Mode	1 : 1 / <u>1:n</u> / Multi-link2 / Multi-link2 (Ethernet) / 1 : n Multi-link2 (Ethernet)	
Signal Level	RS-422/485	
Baud Rate	4800 / <u>9600</u> / 19200 / 38400 bps	
Data Length	8 bits	
Stop Bit	<u>1</u> / 2 bits	
Parity	None / <u>Even</u> / Odd	
Target Port No.	0 to 247	0: Broadcast

Electronic Multimeter

Communication parameters can be set by operating the front-mounted keys of the electronic multimeter. Be sure to match the settings to those made on the [Communication Setting] tab window of the editor.

(Underlined setting: default)

Setting Component	Setting No.	Item	Setting	Example
Adr	231C	Address	<u>1</u> to 247	1
bPS	232C	Baud rate	4800 / <u>9600</u> / 19200 / 38400 bps	9600
PAr	233C	Parity	<u>E</u> : Even o: Odd -: None	E
StoP	234C	Stop bit	<u>1</u> / 2 bits	1
WEr	235C	Protocol version	B : Version B	B

* The communication parameter (data length) is fixed to 8 bits.

Available Memory

The available memory setting range varies depending on the device. Be sure to set within the range available with the device to be used. Use [TYPE] when assigning the indirect memory for macro programs.

Memory	TYPE	Remarks
4 (holding register)	02H	
3 (input register)	03H	Read only

15.2.33 WSZ Series

Communication Setting

Editor

Communication setting

(Underlined setting: default)

Item	Setting	Remarks
Connection Mode	<u>1</u> : 1 / 1 : n / Multi-link2 / Multi-link2 (Ethernet) / 1 : n Multi-link2 (Ethernet)	
Signal Level	<u>RS-232C</u> / RS-422/485	
Baud Rate	4800 / <u>9600</u> / 19200 / 38400 / 57600 / 76800 / 115k bps	
Data Length	<u>7</u> / 8 bits	
Stop Bit	<u>1</u> / 2 bits	
Parity	None / <u>Even</u> / Odd	
Target Port No.	<u>1</u> to 254	

WSZ Series

Make settings for the controller by using the software "WinProLadder". For more information, refer to the instruction manual of the controller issued by the manufacturer.

Station Number

(Underlined setting: default)

Setting Items	Setting	Remarks
Station Number	<u>1</u> to 254	

PORT 0

Comm. Parameters Setting - Port 0

(Underlined setting: default)

Setting Items	Setting	Remarks
Baud Rate	<u>9600</u> / 19200 / 38400 / 57600 / 115200	The baud rate can also be set by specifying a value for the designated address. For more information, refer to the instruction manual of the controller issued by the manufacturer.

* The following settings are fixed; data length: 7, stop bit: 1, parity: even, and protocol: Fatek Communication protocol.

WSZ-CB25 (PORT 1 / PORT 2)

Comm. Parameters Setting - Port 1 / Port 2

(Underlined setting: default)

Setting Items	Setting	Remarks
Baud Rate	4800 / <u>9600</u> / 19200 / 38400 / 57600 / 76800 / 115200	The baud rate can also be set by specifying a value for the designated address. For more information, refer to the instruction manual of the controller issued by the manufacturer.
Parity	None / <u>Even</u> / Odd	
Data Bit	<u>7</u> / 8	
Stop Bit	<u>1</u> / 2	
Protocol	<u>Fatek Communication protocol</u>	

DIPSW

Setting Items	Setting	Remarks
Terminating resistance 	ON: With terminating resistance OFF: Without terminating resistance	This setting must be the same for both switches.

Calendar

This model is equipped with a calendar function; however, the calendar data cannot be written from the TS series. Thus, time correction must be performed on the controller side.

Available Memory

The available memory setting range varies depending on the device. Be sure to set within the range available with the device to be used. Use [TYPE] when assigning the indirect memory for macro programs.

Memory	TYPE	Remarks
R (data register)	00H	
D (data register)	01H	
X (input relay)	02H	WX as word device
Y (output relay)	03H	WY as word device
M (internal relay)	04H	WM as word device
S (step relay)	05H	WS as word device
T (timer/contact)	06H	WT as word device
C (counter/contact)	07H	WC as word device
TR (timer/current value)	08H	
CR (counter/current value)	09H	
32CR (32-bit counter/current value)	0AH	Double-word

Indirect Memory Designation

	15	8	7	0
n + 0	Model		Memory type	
n + 1	Address No.			
n + 2	Expansion code *		Bit designation	
n + 3	00		Station number	

* In the expansion code, set which word, higher or lower, is to be read when a double-word address is specified.

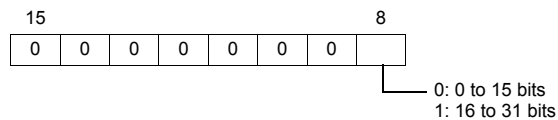

15.2.34 Wiring Diagrams

When Connected at COM1:

RS-422/RS-485

Wiring diagram 1 - COM1

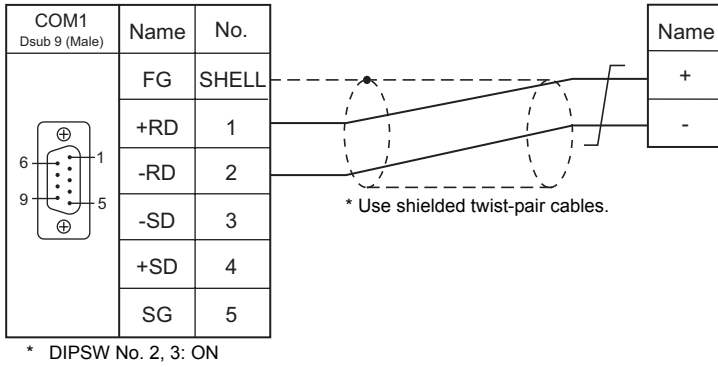

Wiring diagram 2 - COM1

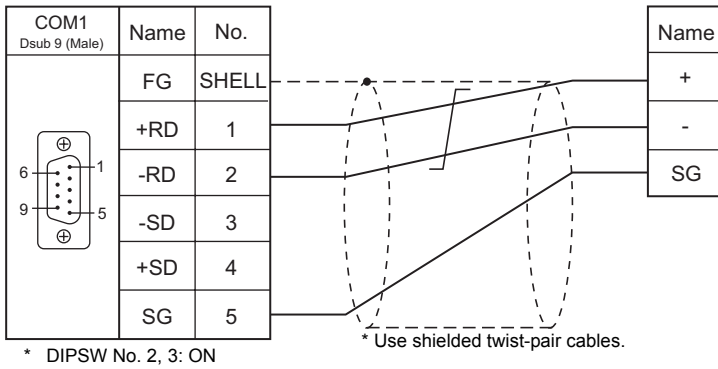

Wiring diagram 3 - COM1

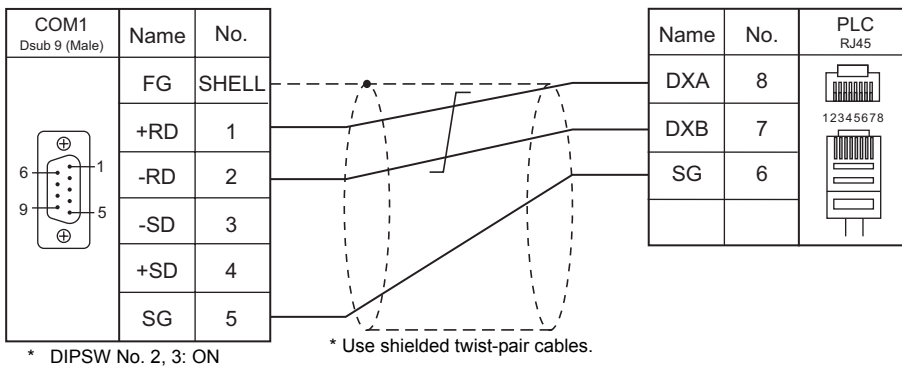

Wiring diagram 4 - COM1

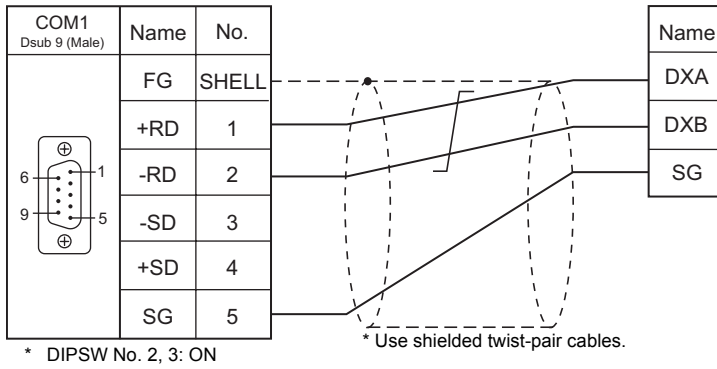

Wiring diagram 5 - COM1

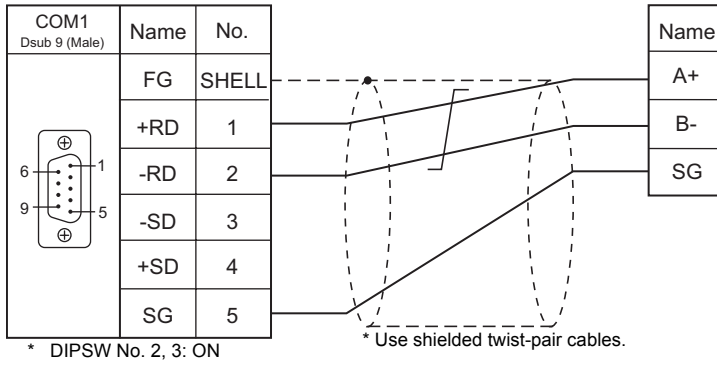

Wiring diagram 6 - COM1

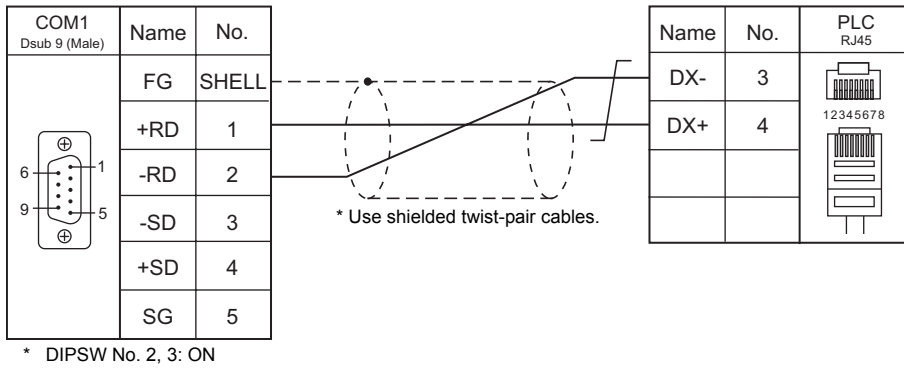

Wiring diagram 7 - COM1

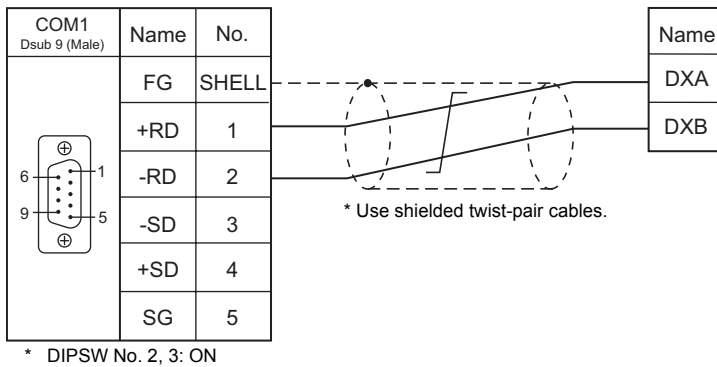

Wiring diagram 8 - COM1

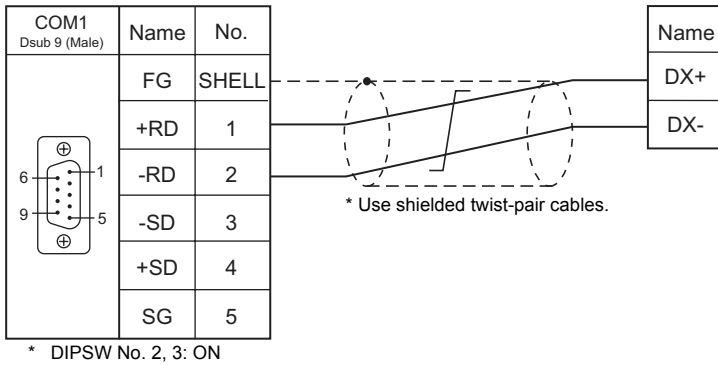

* DIPSW No. 2, 3: ON

Wiring diagram 9 - COM1

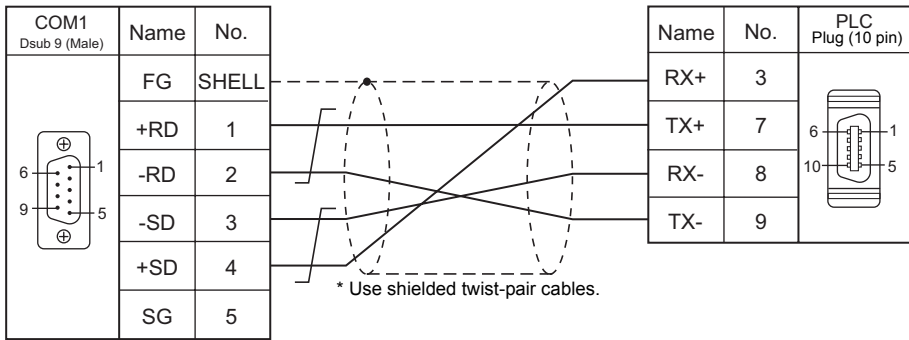

* DIPSW No. 2, 3: OFF

Wiring diagram 10 - COM1

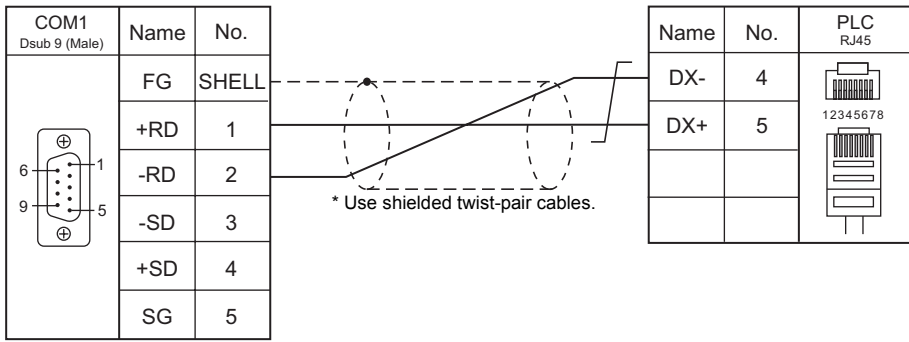

* DIPSW No. 2, 3: ON

Wiring diagram 11 - COM1

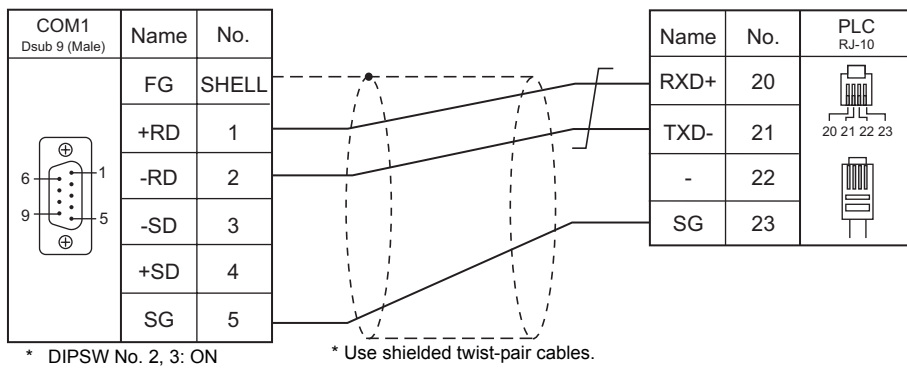

* DIPSW No. 2, 3: ON

Wiring diagram 12 - COM1

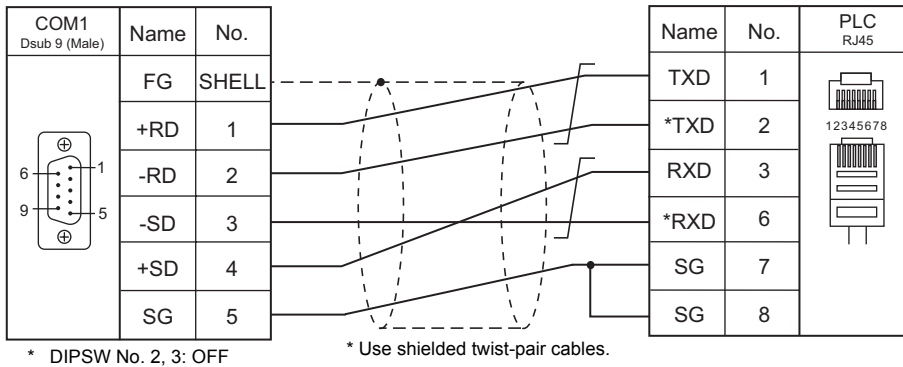

Wiring diagram 13 - COM1

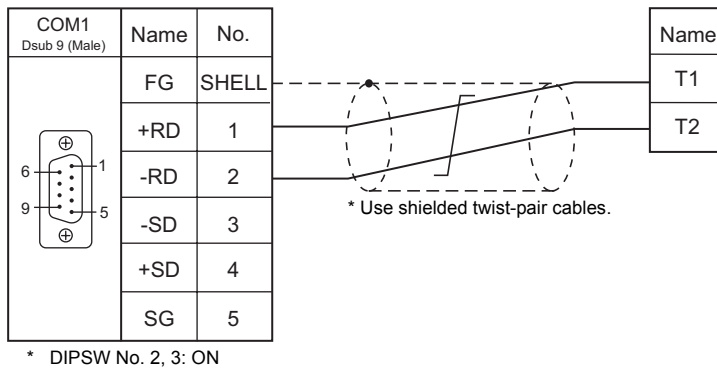

Wiring diagram 14 - COM1

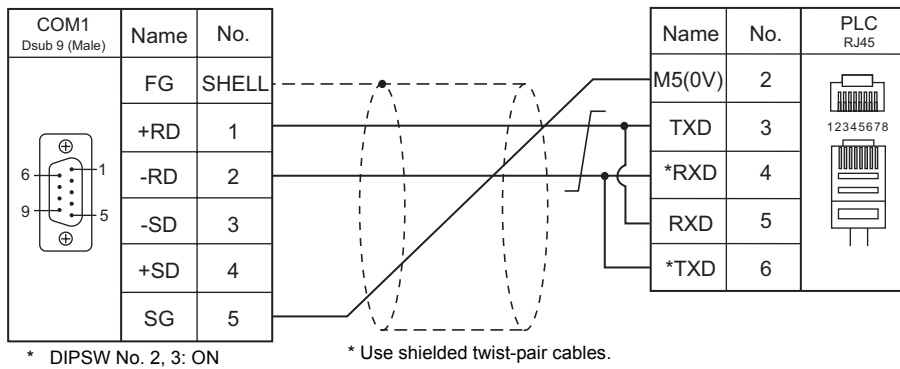

Wiring diagram 15 - COM1

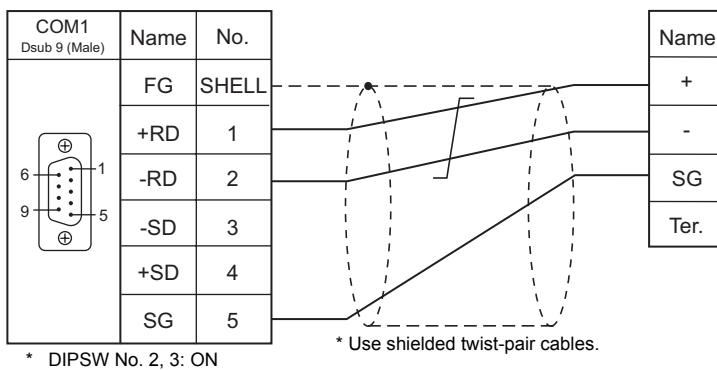

Electronic multimeter connected at the terminal

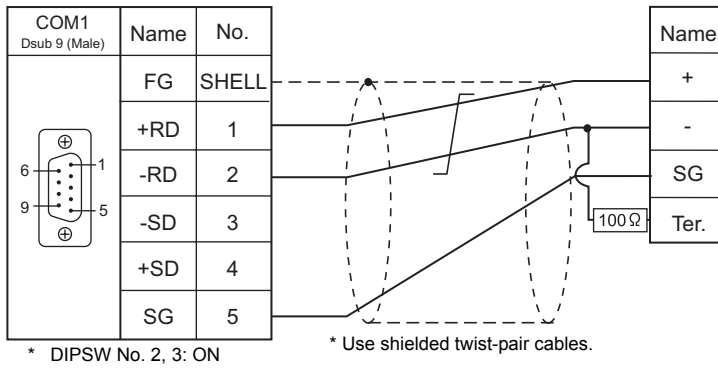

Wiring diagram 16 - COM1

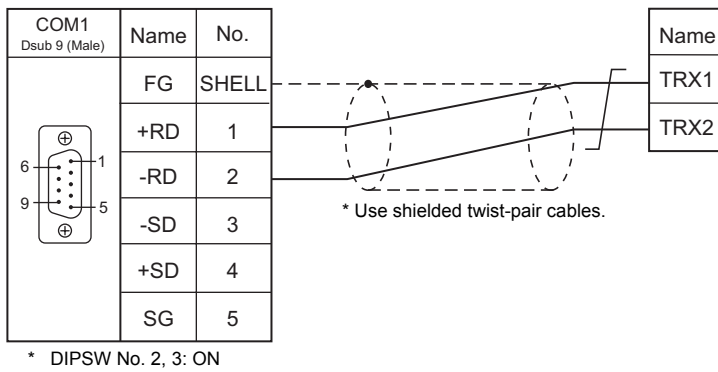

Wiring diagram 17 - COM1

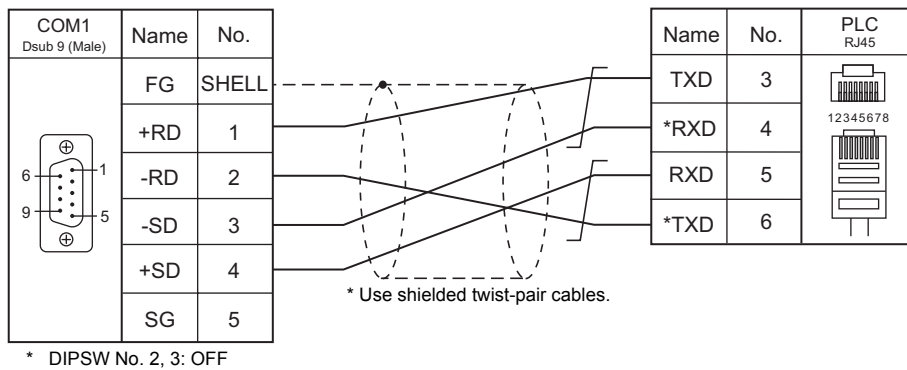

Wiring diagram 18 - COM1

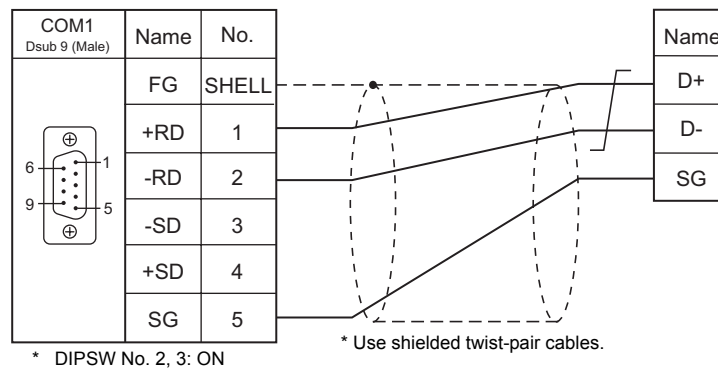

When Connected at COM2:

RS-232C

Wiring diagram 1 - COM2

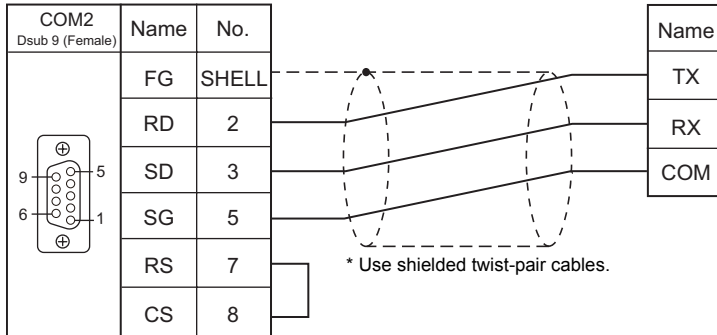

Wiring diagram 2 - COM2

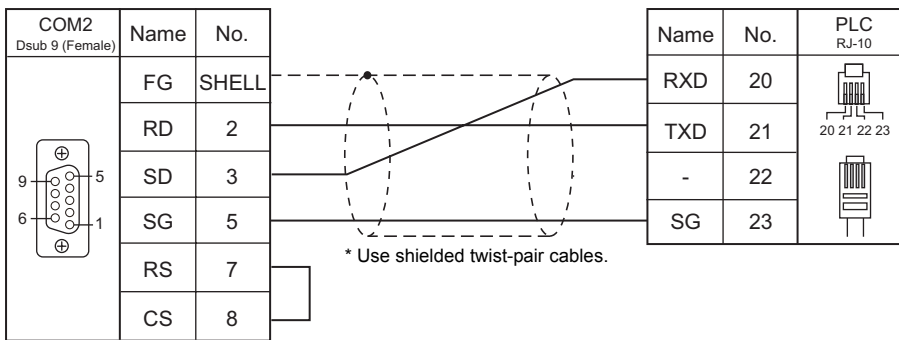

Wiring diagram 3 - COM2

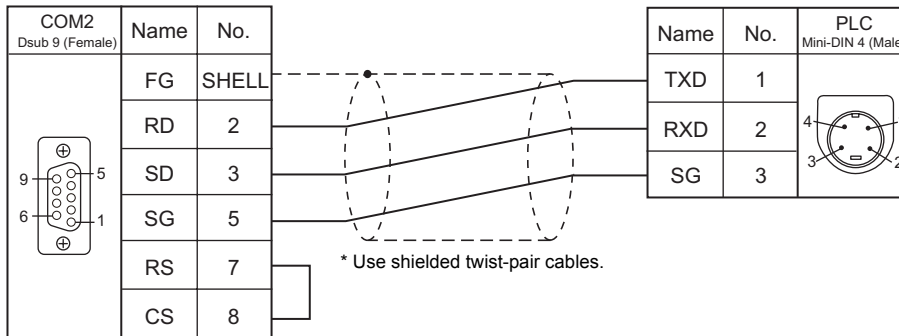

Wiring diagram 4 - COM2

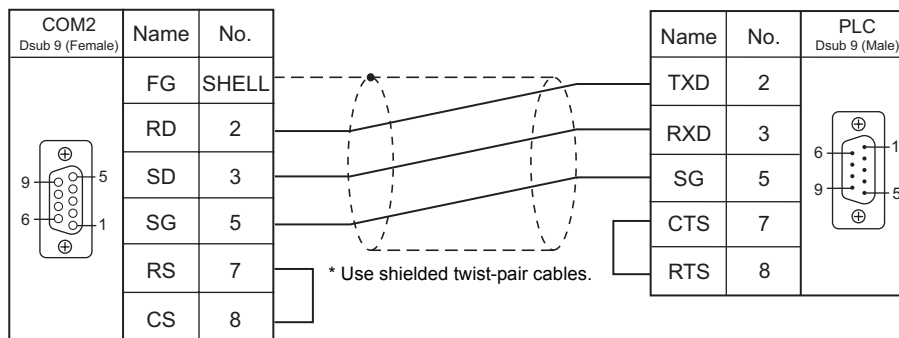

When Connected at COM3:

RS-485

Wiring diagram 1 - COM3

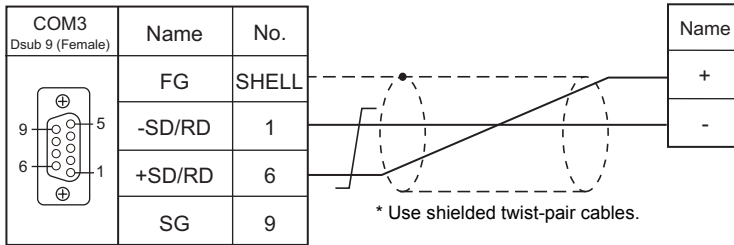

Wiring diagram 2 - COM3

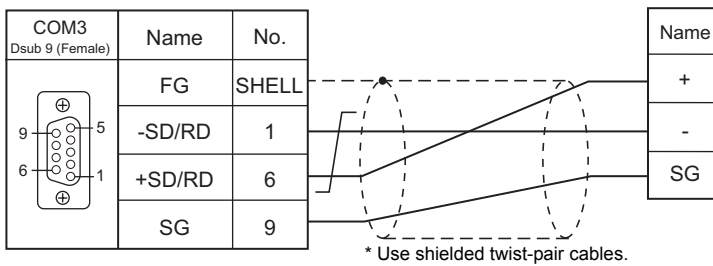

Wiring diagram 3 - COM3

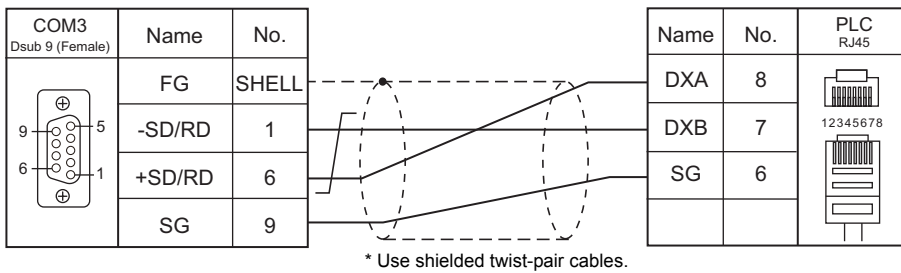

Wiring diagram 4 - COM3

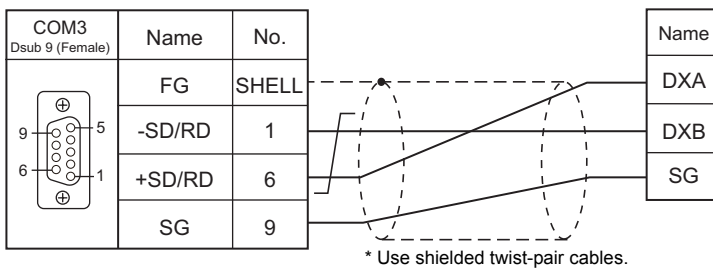

Wiring diagram 5 - COM3

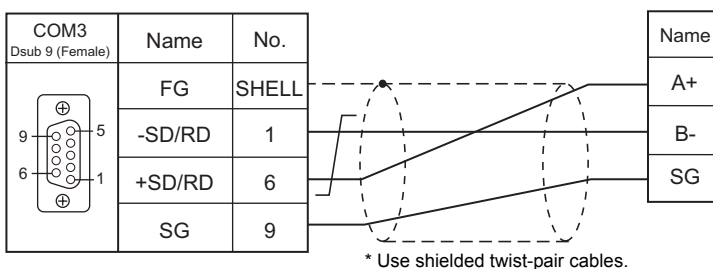

Wiring diagram 6 - COM3

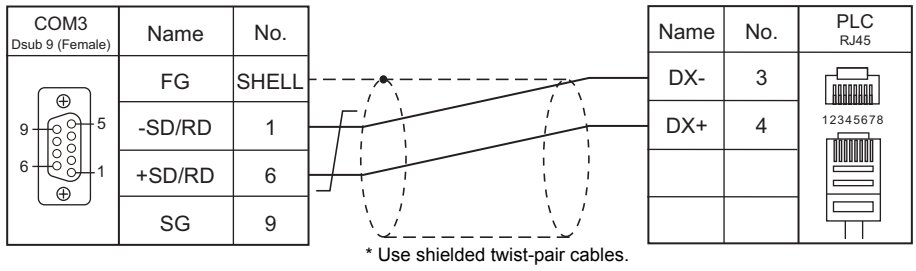

Wiring diagram 7 - COM3

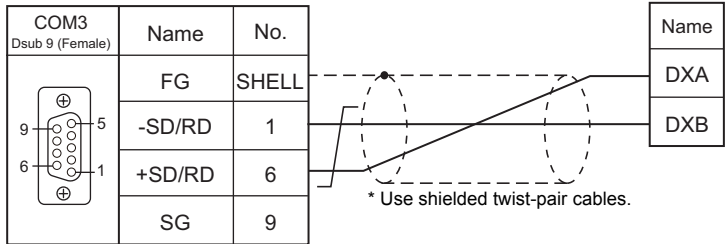

Wiring diagram 8 - COM3

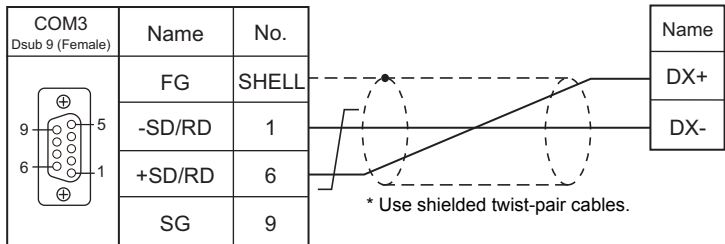

Wiring diagram 9 - COM3

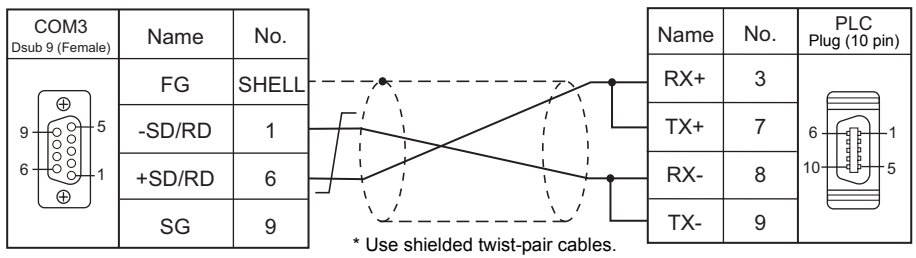

Wiring diagram 10 - COM3

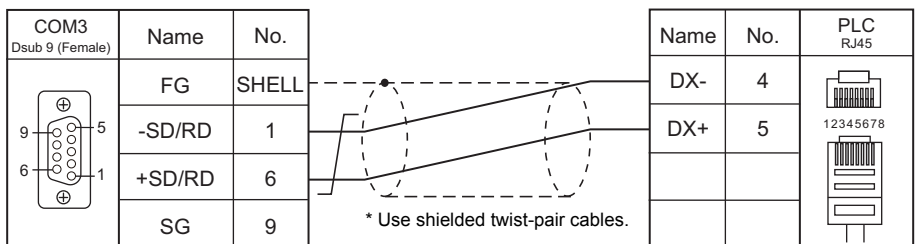

Wiring diagram 11 - COM3

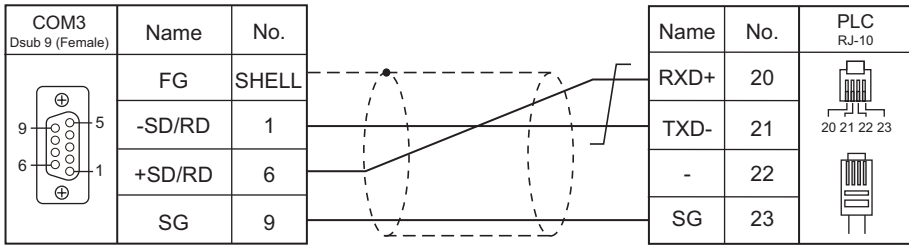

Wiring diagram 12 - COM3

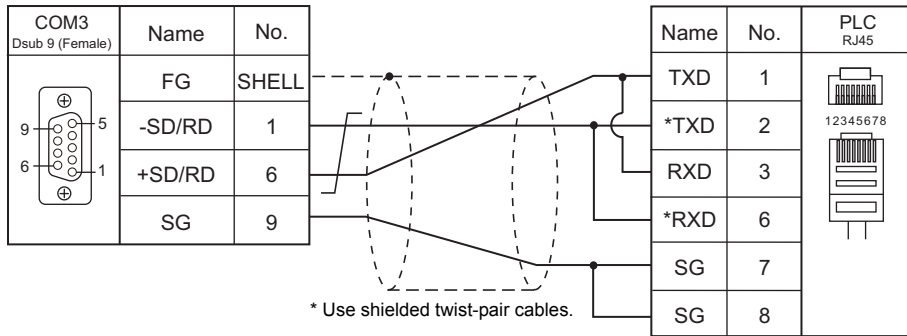

Wiring diagram 13 - COM3

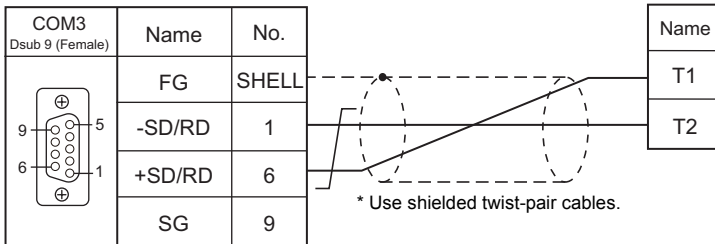

Wiring diagram 14 - COM3

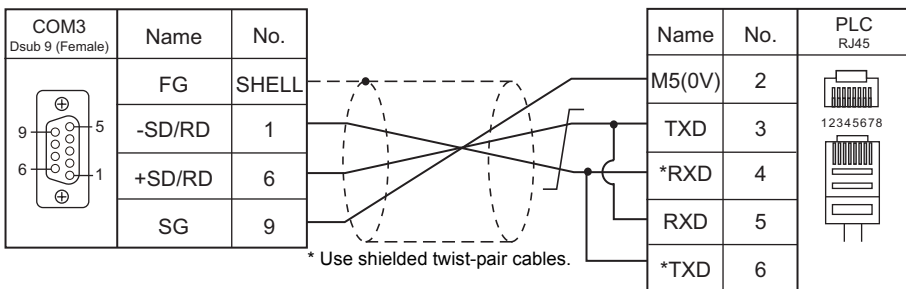

Wiring diagram 15 - COM3

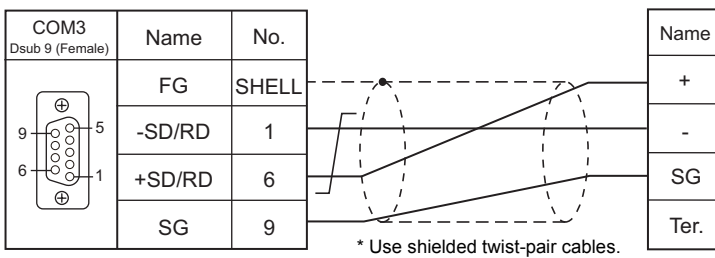

Electronic multimeter connected at the terminal

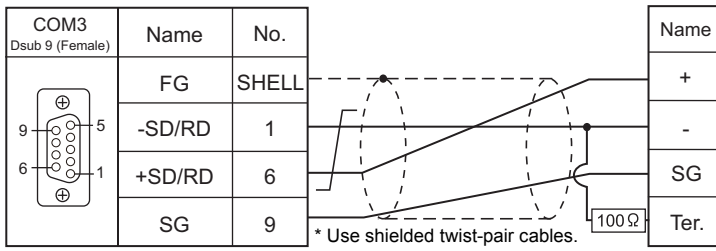

Wiring diagram 16 - COM3

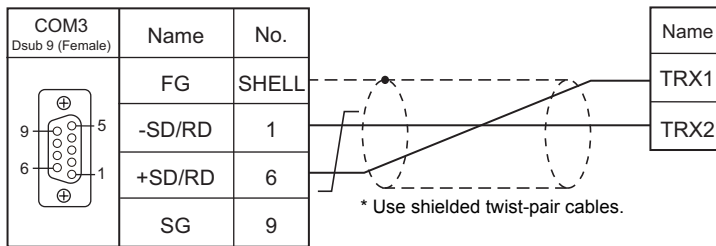

Wiring diagram 17 - COM3

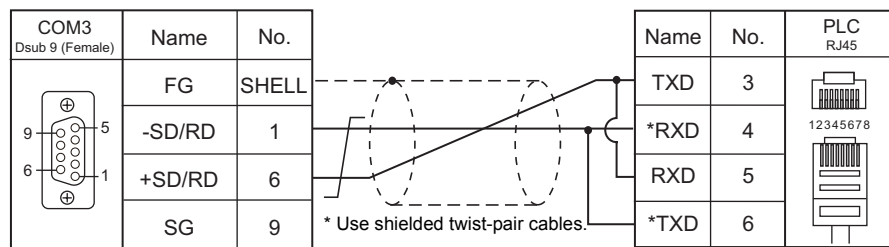

Wiring diagram 18 - COM3

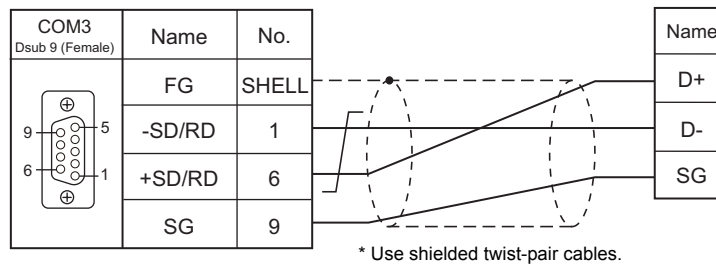

16. GE Fanuc

16.1 PLC Connection

16.1 PLC Connection

Serial Connection

PLC Selection on the Editor	CPU	Unit/Port	Signal Level	TS Port	Connection	Ladder Transfer *1		
90 series	IC693CPU331, IC693CPU340 IC693CPU341, IC693CPU350 IC693CPU351, IC693CPU352 IC693CPU360, IC693CPU363 IC693CPU364, IC693CPU366 IC693CPU367, IC693CPU370 IC693CPU372, IC693CPU374	IC693CMM 311	Port 1	RS-232C	COM2	Wiring diagram 1 - COM2	×	
			Port 2	RS-232C	COM2	Wiring diagram 2 - COM2		
				RS-422	COM1	Wiring diagram 2 - COM1		
			RS-485	COM3	Wiring diagram 2 - COM3			
90 series (SNP-X)	IC698CPE010, IC698CPE020 IC698CRE020, IC697CPU731 IC697CPX772, IC697CPX782 IC697CPX928, IC697CPX935 IC697CPU780, IC697CGR772 IC697CGR935, IC697CPU789 IC697CPM790	IC697CMM 711	Port 1/ Port 2	RS-422	COM1	Wiring diagram 2 - COM1	×	
				RS-485	COM3	Wiring diagram 2 - COM3		
	IC693CPU350, IC693CPU360 IC693CPU363, IC693CPU364 IC693CPU366, IC693CPU367 IC693CPU374	COM port of the CPU	RS-422	COM1	Wiring diagram 1 - COM1			
90 series (SNP)	90-30 series	IC693CPU311 IC693CPU313 IC693CPU323 IC693CPU331 IC693CPU340 IC693CPU341 IC693CPU350 IC693CPU360 IC693CPU364 IC693CPU366 IC693CPU367 IC693CPU370 IC693CPU372 IC693CPU374 PLUS	Serial port (power supply)		RS-422	COM1	Wiring diagram 1 - COM1	×
					RS-485	COM3	Wiring diagram 1 - COM3	
			IC693CMM 311	Port 1	RS-232C	COM2	Wiring diagram 1 - COM2	
					RS-232C	COM2	Wiring diagram 2 - COM2	
			Port 2	RS-422	COM1	Wiring diagram 2 - COM1		
				RS-485	COM3	Wiring diagram 2 - COM3		
		IC693CPU351 IC693CPU352 IC693CPU363	Serial port (power supply)		RS-422	COM1	Wiring diagram 1 - COM1	
					RS-485	COM3	Wiring diagram 1 - COM3	
			PORT1		RS-232C	COM2	Wiring diagram 3 - COM2	
			PORT2		RS-422	COM1	Wiring diagram 1 - COM1	
					RS-485	COM3	Wiring diagram 1 - COM3	
			IC693CMM 311	Port 1	RS-232C	COM2	Wiring diagram 1 - COM2	
	RS-232C	COM2			Wiring diagram 2 - COM2			
	Port 2	RS-422	COM1	Wiring diagram 2 - COM1				
		RS-485	COM3	Wiring diagram 2 - COM3				
	90-70 series	IC697CPU731 IC697CPU780 IC697CPU789 IC697CPM790	Serial Port		RS-422	COM1	Wiring diagram 1 - COM1	×
					RS-485	COM3	Wiring diagram 1 - COM3	
			IC697CMM 711	Port 1/ Port 2	RS-232C	COM2	Wiring diagram 1 - COM2	
RS-422					COM1	Wiring diagram 2 - COM1		
Port 2			RS-485	COM3	Wiring diagram 2 - COM3			
			RS-485	COM3	Wiring diagram 2 - COM3			
IC697CPX772 IC697CPX782 IC697CPX928 IC697CPX935 IC697CGR772 IC697CGR935		Serial Port1		RS-232C	COM2	Wiring diagram 3 - COM2		
		Serial Port2		RS-422	COM1	Wiring diagram 1 - COM1		
		Serial Port3		RS-485	COM3	Wiring diagram 1 - COM3		
		IC697CMM 711	Port 1/ Port 2	RS-232C	COM2	Wiring diagram 1 - COM2		
				RS-422	COM1	Wiring diagram 2 - COM1		
		RS-485	COM3	Wiring diagram 2 - COM3				

PLC Selection on the Editor	CPU		Unit/Port		Signal Level	TS Port	Connection	Ladder Transfer *1		
90 series (SNP)	PACSystems RX3i	IC695CPU310 IC695CPU315 IC695CPU320 IC695CMU310 IC695CRU320 IC695CPE310	COM1		RS-232C	COM2	Wiring diagram 4 - COM2	×		
			COM2		RS-422	COM1	Wiring diagram 1 - COM1			
					RS-485	COM3	Wiring diagram 1 - COM3			
		IC695CPE305	COM1		RS-232C	COM2	Wiring diagram 6 - COM2 + GE Fanuc "IC963CBL316"			
			PACSystems RX7i	IC698CPE010 IC698CPE020 IC698CPE030 IC698CPE040 IC698CRE020 IC698CRE030 IC698CRE040	COM1		RS-232C		COM2	Wiring diagram 4 - COM2
					COM2		RS-422		COM1	Wiring diagram 1 - COM1
	IC697CMM 711	Port 1/ Port 2	COM2				RS-485		COM3	Wiring diagram 1 - COM3
					RS-232C	COM2	Wiring diagram 2 - COM2			
			PORT1		RS-422	COM1	Wiring diagram 2 - COM1			
					RS-485	COM3	Wiring diagram 2 - COM3			
	VersaMax	IC200CPU001 IC200CPU002 IC200CPU005 IC200CPUE05	PORT2		RS-232C	COM2	Wiring diagram 4 - COM2			
			PORT1		RS-422	COM1	Wiring diagram 1 - COM1			
					RS-485	COM3	Wiring diagram 1 - COM3			
	VersaMax Micro & Nano	Nano 10 PLCs Micro 14 PLCs	Serial Port		RS-232C	COM2	Wiring diagram 5 - COM2			
			Micro 23 PLCs Micro 28 PLCs	Serial Port 1		RS-232C	COM2		Wiring diagram 5 - COM2	
		Serial Port 2		RS-422	COM1	Wiring diagram 1 - COM1				
				RS-485	COM3	Wiring diagram 1 - COM3				
		Micro 20 PLCs Micro 40 PLCs Micro 64 PLCs	Serial Port		RS-232C	COM2	Wiring diagram 5 - COM2			
			IC200USB001		RS-232C	COM2	Wiring diagram 5 - COM2			
			IC200USB002		RS-422	COM1	Wiring diagram 3 - COM1			
RS-485					COM3	Wiring diagram 3 - COM3				

*1 For the ladder transfer function, see "Appendix 5 Ladder Transfer Function".

Ethernet Connection

PLC Selection on the Editor	CPU		Unit	TCP/IP	UDP/IP	Port No.	Ladder Transfer *1
90 series (Ethernet TCP/IP)	Series 90-70		IC697CMM742 (Type 2)	○	×	Fixed to 18245	×
	Series 90-30		IC693CMM321	○	×		
			CPU with built-in port				
RX3i (Ethernet TCP/IP)	PACSystems RX3i	IC695CPU310	ETM001	○	×	18245 fixed	×

*1 For the ladder transfer function, see "Appendix 5 Ladder Transfer Function".

16.1.1 90 Series

Communication Setting

Editor

Communication setting

(Underlined setting: default)

Item	Setting	Remarks
Connection Mode	<u>1:1</u> / 1:n / Multi-link2 / Multi-link2 (Ethernet)	
Signal Level	<u>RS-232C</u> / RS-422/485	
Baud Rate	4800 / 9600 / <u>19200</u> bps	
Data Length	8 bits	
Stop Bit	1 bit	
Parity	None / <u>Odd</u>	
Target Port No.	1 to 31	

PLC

Be sure to match the settings to those made on the [Communication Setting] tab window of the editor.

PCM

(Underlined setting: default)

Item	Setting	Remarks	
Configuration Mode	CCM ONLY, BAS/CCM, PROG/CCM, CCM/PROG		
Port 1	CCM Enable	YES	
	CCM Mode	SLAVE	
	Interface	RS-232	
	Date Rate	4800 / 9600 / <u>19200</u> bps	
	Flow Control	NONE	
	Parity	NONE / <u>ODD</u>	
	Retry Count	<u>NORMAL</u> / SHORT	
	Timeout	<u>LONG</u> / MEDIUM / SHORT / NONE	
	Turnaround Delay	<u>NONE</u> / 10 ms / 100 ms / 500 ms	
	CPU ID	1 to 31	
Port 2	CCM Enable	YES	
	CCM Mode	SLAVE	
	Interface	<u>RS-232</u> / RS-485	Only RS-485 is available with IC693PCM300.
	Date Rate	4800 / 9600 / <u>19200</u> bps	
	Flow Control	NONE	
	Parity	NONE / <u>ODD</u>	
	Retry Count	<u>NORMAL</u> / SHORT	
	Timeout	<u>LONG</u> / MEDIUM / SHORT / NONE	
	Turnaround Delay	<u>NONE</u> / 10 ms / 100 ms / 500 ms	
	CPU ID	1 to 31	

Calendar

This model is not equipped with the calendar function. Use the built-in clock of the TS series.

IC693CMM311

(Underlined setting: default)

Item	Setting	Remarks
Configuration Mode	CCM ONLY, CCM/RTU, RTU/CCM, SNP/CCM, CCM/SNP	
Port 1	CCM Enable	YES
	CCM Mode	SLAVE
	Interface	RS-232
	Date Rate	4800 / 9600 / <u>19200</u> bps
	Flow Control	NONE
	Parity	NONE / <u>ODD</u>
	Retry Count	<u>NORMAL</u> / SHORT
	Timeout	<u>LONG</u> / MEDIUM / SHORT / NONE
	Turnaround Delay	<u>NONE</u> / 10 ms / 100 ms / 500 ms
	CCM CPU ID	1 to 31
Port 2	CCM Enable	YES
	CCM Mode	SLAVE
	Interface	<u>RS-232</u> / RS-485
	Date Rate	4800 / 9600 / <u>19200</u> bps
	Flow Control	NONE
	Parity	NONE / <u>ODD</u>
	Retry Count	<u>NORMAL</u> / SHORT
	Timeout	<u>LONG</u> / MEDIUM / SHORT / NONE
	Turnaround Delay	<u>NONE</u> / 10 ms / 100 ms / 500 ms
	CCM CPU ID	1 to 31

Calendar

This model is not equipped with the calendar function. Use the built-in clock of the TS series.

Available Memory

The available memory setting range varies depending on the PLC model. Be sure to set within the range available with the PLC to be used. Use [TYPE] when assigning the indirect memory for macro programs.

Memory	TYPE	Remarks
R (register)	00H	
I (input)	01H	
Q (output)	02H	

Indirect Memory Designation

Specify the value subtracted "1" from the real memory address for the memory address No..

16.1.2 90 Series (SNP-X)

Communication Setting

Editor

Communication setting

(Underlined setting: default)

Item	Setting	Remarks
Connection Mode	<u>1:1</u> / Multi-link2	
Signal Level	RS-232C / <u>RS-422/485</u>	
Baud Rate	4800 / 9600 / <u>19200</u> bps	
Data Length	8 bits	
Stop Bit	<u>1</u> / 2 bits	
Parity	None / <u>Odd</u> / Even	

PLC

Be sure to match the settings to those made on the [Communication Setting] tab window of the editor.

90 series (SNP-X)

Item	Setting	Remarks
Baud Rate	19200 bps	
Parity	Odd	
Transmission code	Data Length	8 bits
	Stop Bit	1 bit
Function	SNP-X	

Calendar

This model is not equipped with the calendar function. Use the built-in clock of the TS series.

Available Memory

The available memory setting range varies depending on the PLC model. Be sure to set within the range available with the PLC to be used. Use [TYPE] when assigning the indirect memory for macro programs.

Memory	TYPE	Remarks
R (register)	00H	
I (input)	01H	
Q (output)	02H	
M (internal relay)	03H	
G (global relay)	04H	
AI (analog input)	05H	
AQ (analog output)	06H	
T (temporary memory relay)	07H	
S (system status)	08H	Read only
SA (system status)	09H	
SB (system status)	0AH	
SC (system status)	0BH	

Indirect Memory Designation

Specify the value subtracted "1" from the real memory address for the memory address No..

16.1.3 90 Series (SNP)

Communication Setting

Editor

Communication setting

(Underlined setting: default)

Item	Setting	Remarks
Connection Mode	<u>1:1</u> / Multi-link2 / Multi-link2 (Ethernet)	
Signal Level	<u>RS-232C</u> / RS-422/485	
Baud Rate	4800 / 9600 / <u>19200</u> / 38400 / 57600 / 115K bps	
Data Length	<u>8 bits</u>	
Stop Bit	<u>1</u> / 2 bits	
Parity	None / <u>Odd</u> / Even	

PLC

Be sure to match the settings to those made on the [Communication Setting] tab window of the editor.

IC693CMM311 / IC697CMM711

(Underlined setting: default)

Item	Setting	Remarks	
Configuration Mode	SNP ONLY, SNP/CCM, CCM/SNP, SNP/RTU, RTU/SNP		
Port 1	SNP Enable	YES	
	SNP Mode	SLAVE	
	Interface	<u>RS485</u> / RS232	Only RS232C supported by IC693CMM311
	Date Rate	4800 / 9600 / <u>19200</u> bps	
	Flow Control	NONE	
	Parity	<u>ODD</u> / EVEN / NONE	
	Stop Bits	<u>1</u> / 2	
	Timeout	<u>LONG</u> / MEDIUM / SHORT / NONE	
Modem Turnaround Delay	<u>NONE</u> / 10 ms / 100 ms / 500 ms		
Port 2	SNP Enable	YES	
	SNP Mode	SLAVE	
	Interface	<u>RS485</u> / RS232	
	Date Rate	4800 / 9600 / <u>19200</u> bps	
	Flow Control	NONE	
	Parity	<u>ODD</u> / EVEN / NONE	
	Stop Bits	<u>1</u> / 2	
	Timeout	<u>LONG</u> / MEDIUM / SHORT / NONE	
Modem Turnaround Delay	<u>NONE</u> / 10 ms / 100 ms / 500 ms		

90-30 Series / 90-70 Series

(Underlined setting: default)

Parameter	Setting	Remarks
Port Mode	SNP Slave	
Data Rate	4800 / 9600 / <u>19200</u> bps	
Parity	<u>ODD</u> / EVEN / NONE	
Stop Bits	<u>1</u> / 2	
Physical Interface	2-wire / <u>4-wire</u>	Both valid for RS232

PAC Systems

(Underlined setting: default)

Parameter	Setting	Remarks
Port Mode	SNP Slave	
Data Rate	4800 / 9600 / <u>19200</u> / 38400 / 57600 / 115200 bps	
Parity	<u>ODD</u> / EVEN / NONE	
Stop Bits	1	
Physical Interface	2-wire / <u>4-wire</u>	Both valid for RS232

VersaMax / VersaMax Micro & Nano / IC200USB001 / IC200USB002

(Underlined setting: default)

Parameter	Setting	Remarks
Port Mode	SNP	
Port Type	Slave	
Data Rate	4800 / 9600 / <u>19200</u> / 38400 bps	
Parity	<u>ODD</u> / EVEN / NONE	
Stop Bits	<u>1</u> / 2	
Physical Interface	2-wire / <u>4-wire</u>	Both valid for RS232

Calendar

This model is not equipped with the calendar function. Use the built-in clock of the TS series.

Available Memory

The available memory setting range varies depending on the PLC model. Be sure to set within the range available for the PLC. Use [TYPE] when assigning the indirect memory for macro programs.

Memory	TYPE	Remarks
R (register)	00H	
I (input)	01H	
Q (output)	02H	
M (internal relay)	03H	
G (global relay)	04H	
AI (analog input)	05H	
AQ (analog output)	06H	
T (temporary memory relay)	07H	
S (system status)	08H	Read only
SA (system status)	09H	
SB (system status)	0AH	
SC (system status)	0BH	
P (local subblock data)	0CH	90-70 series only
L (program block data)	0DH	90-70 series only

Indirect Memory Designation

Specify the value obtained by subtracting "1" from the real memory address for the memory address number.

16.1.4 90 Series (Ethernet TCP/IP)

Communication Setting

Editor

Make the following settings on the editor. For more information, see Appendix 2 Ethernet.

- IP address for the TS unit
 - When specified on the screen data:
[System Setting] → [Ethernet Communication] → [Local Port IP Address]
 - When specified on the TS unit:
Main Menu screen → [Ethernet]
- Port number for the TS unit (for communication with PLC)
[System Setting] → [Device Connection Setting] → [Communication Setting]
- IP address and port number (No. 18245) of the PLC
[System Setting] → [Device Connection Setting] → [PLC Table]

PLC

Parameters

Parameters	Values
Configuration Mode:	TCP/IP
Adapter Name:	0.1
IP Address:	10.91.131.229
Subnet Mask:	255.255.255.0
Gateway IP Address:	10.91.131.1
Status Address:	%I00001
Status Length:	80
Network Time Sync:	SNTP
Max number of Web Server Connection:	1
Max number of FTP Server Connection:	2

Item	Setting	Remarks
IP Address	Set the IP address of the PLC.	
Subnet Mask	Set the subnet mask of the PLC.	
Gateway IP Address	Make settings in accordance with the network environment.	

Calendar

This model is not equipped with the calendar function. Use the built-in clock of the TS series.

Available Memory

The available memory setting range varies depending on the PLC model. Be sure to set within the range available with the PLC to be used. Use [TYPE] when assigning the indirect memory for macro programs.

Memory	TYPE	Remarks
R (register)	00H	
I (input)	01H	
Q (output)	02H	
M (internal relay)	03H	
G (global relay)	04H	
AI (analog input)	05H	
AQ (analog output)	06H	
T (temporary memory relay)	07H	
S (system status)	08H	Read only
SA (system status)	09H	
SB (system status)	0AH	
SC (system status)	0BH	

Indirect Memory Designation

Specify the value subtracted "1" from the real memory address for the memory address No..

16.1.5 RX3i (Ethernet TCP/IP)

Communication Setting

Editor

Make the following settings on the editor. For more information, see Appendix 2 Ethernet.

- IP address for the TS unit
 - When specified on the screen data:
[System Setting] → [Ethernet Communication] → [Local Port IP Address]
 - When specified on the TS unit:
Main Menu screen → [Ethernet]
- Port number for the TS unit (for communication with PLC)
[System Setting] → [Device Connection Setting] → [Communication Setting]
- IP address and port number (No. 18245) of the PLC
[System Setting] → [Device Connection Setting] → [PLC Table]

PLC

Parameters

Item	Setting	Remarks
IP Address	Set the IP address of the PLC.	
Subnet Mask	Set the subnet mask of the PLC.	
Gateway IP Address	Specify according to the environment.	

Calendar

This model is not equipped with the calendar function. Use the built-in clock of the TS series.

Available Memory

The available memory setting range varies depending on the PLC model. Be sure to set within the range available for the PLC. Use [TYPE] when assigning the indirect memory for macro programs.

Memory	TYPE	Remarks
R (register)	00H	
I (input)	01H	
Q (output)	02H	
M (internal relay)	03H	
G (global relay)	04H	
AI (analog input)	05H	
AQ (analog output)	06H	
T (temporary memory relay)	07H	
S (system status)	08H	Read only
SA (system status)	09H	
SB (system status)	0AH	
SC (system status)	0BH	

Indirect Memory Designation

Specify the value obtained by subtracting "1" from the real memory address for the memory address number.

16.1.6 Wiring Diagrams

When Connected at COM1:

RS-422

Wiring diagram 1 - COM1

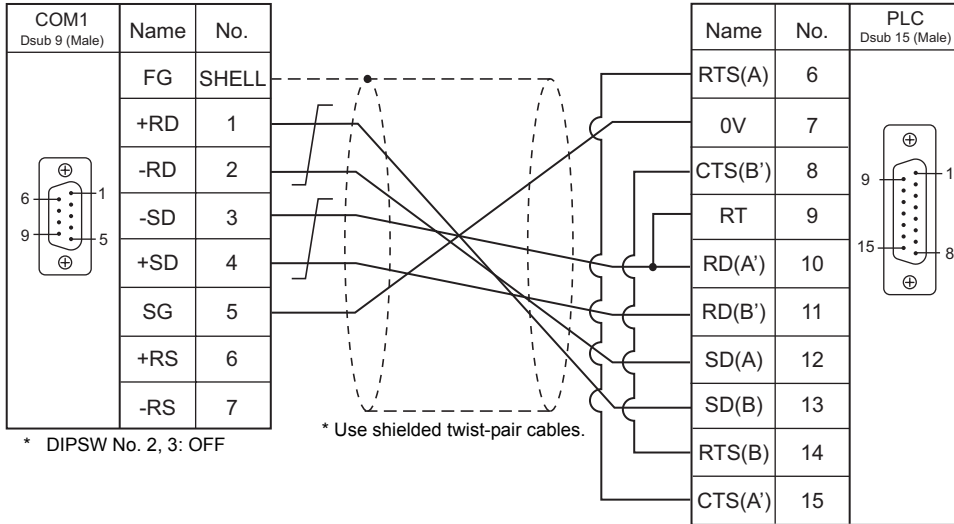

Wiring diagram 2 - COM1

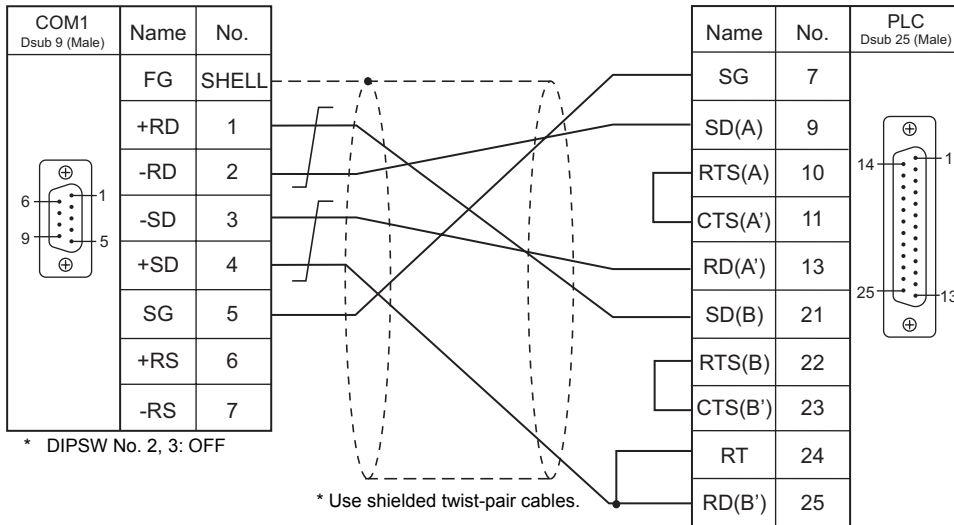

Wiring diagram 3 - COM1

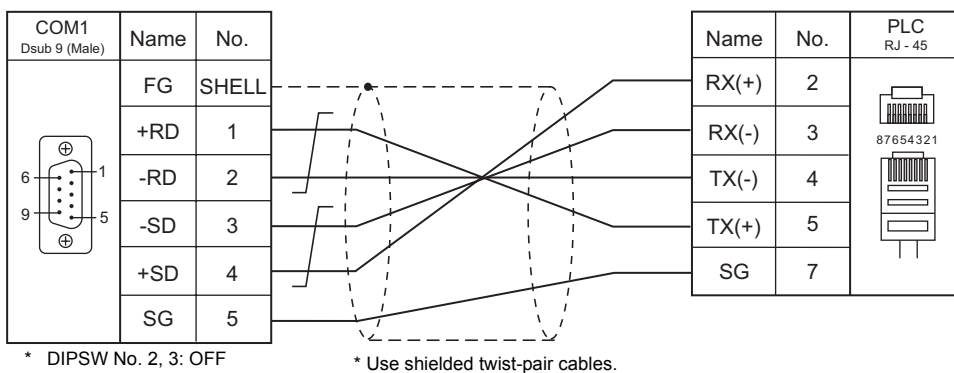

When Connected at COM2:

RS-232C

Wiring diagram 1 - COM2

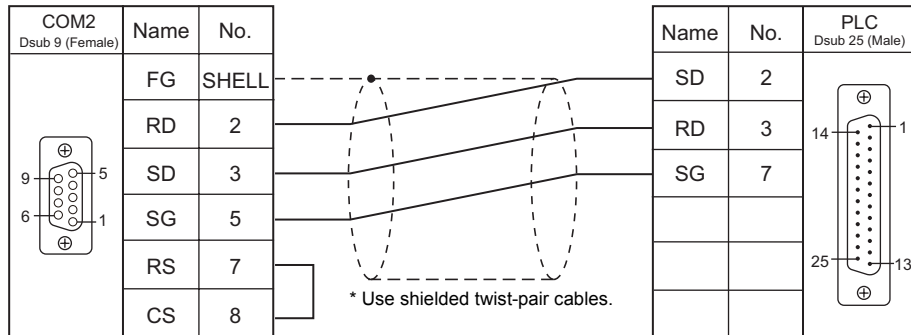

Wiring diagram 2 - COM2

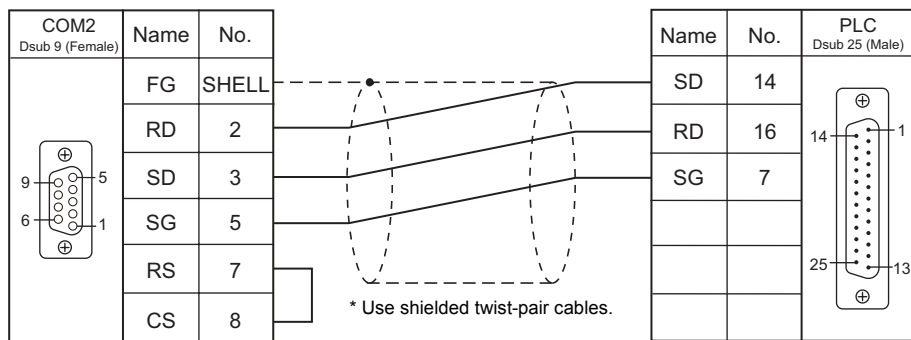

Wiring diagram 3 - COM2

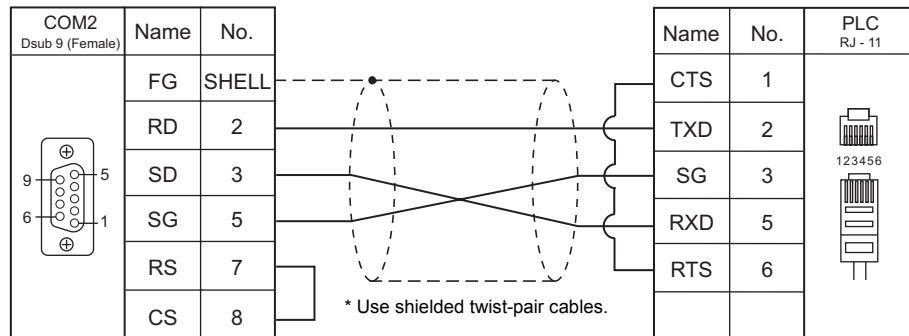

Wiring diagram 4 - COM2

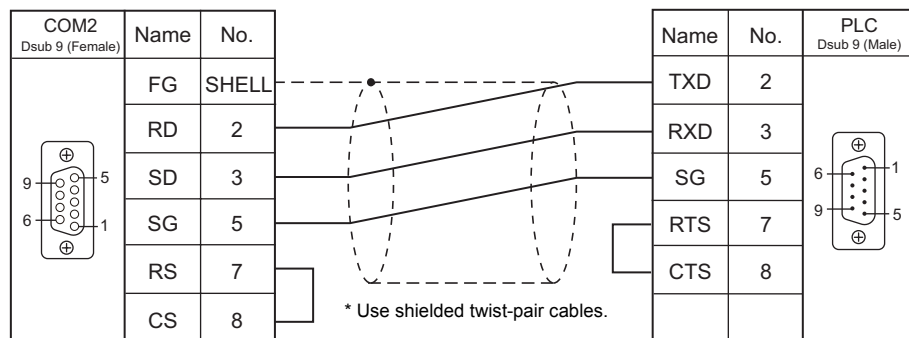

Wiring diagram 5 - COM2

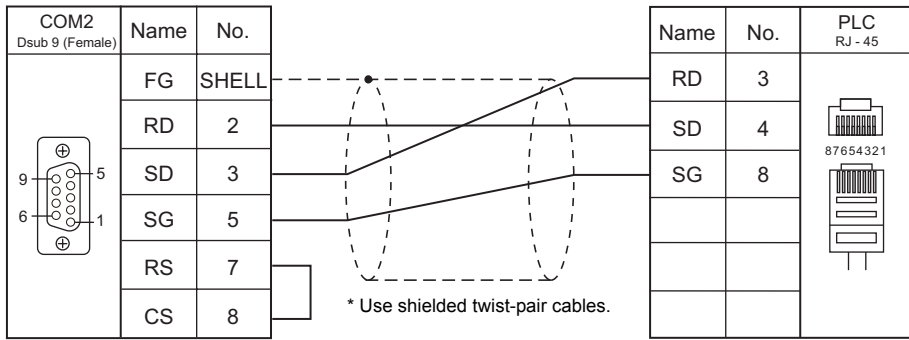

Wiring diagram 6 - COM2

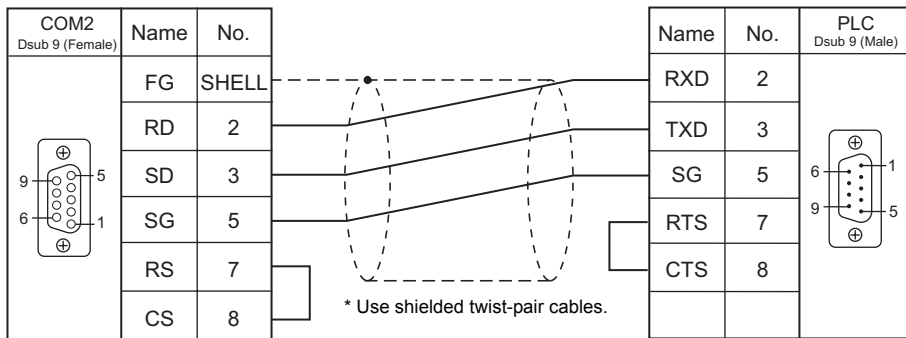

When Connected at COM3:

RS-485

Wiring diagram 1 - COM3

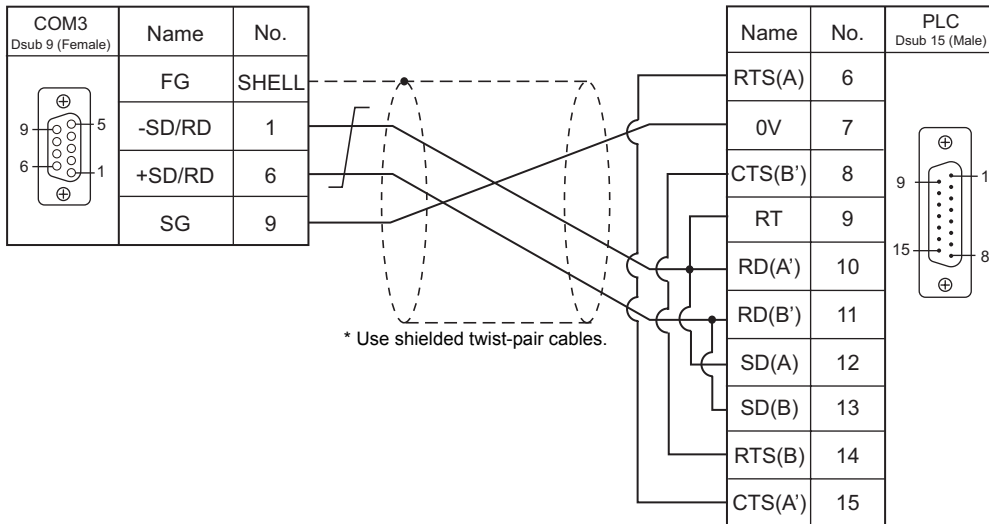

Wiring diagram 2 - COM3

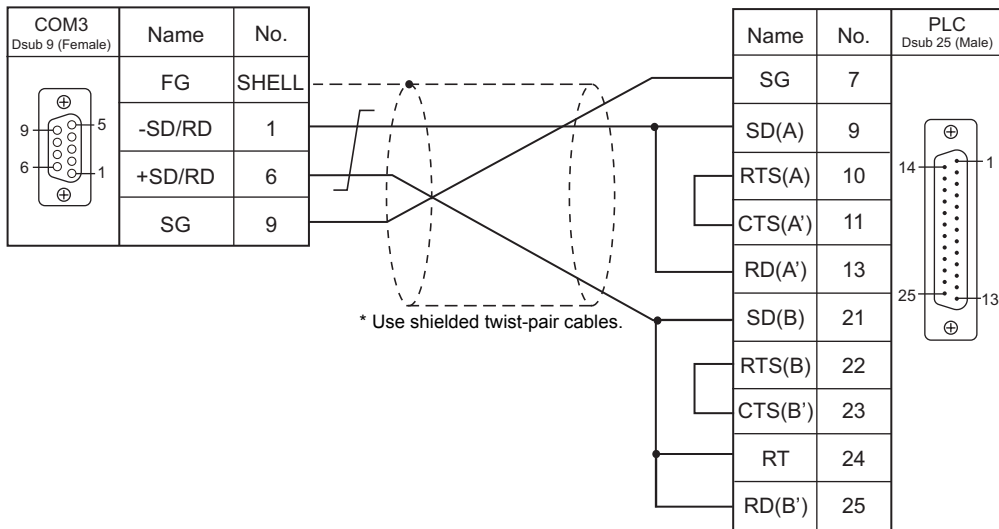

Wiring diagram 3 - COM3

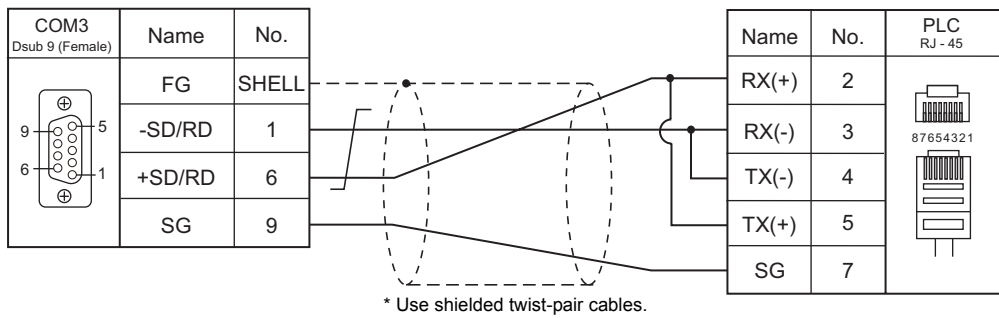

MEMO

Please use this page freely.

17. Hitachi

17.1 PLC Connection

17.1 PLC Connection

Serial Connection

PLC Selection on the Editor	CPU	Unit/Port	Signal Level	TS Port	Connection	Ladder Transfer ^{*1}
HIDIC-S10/2 α , S10mini	S10 2 α	Interface on the CPU unit	RS-422	COM1	Wiring diagram 1 - COM1	×
	LQP000 LQP010 LQP011 LQP120	RS-232C connector on the CPU unit	RS-232C	COM2	Wiring diagram 1 - COM2	
		LQE060 (CN1,CN2)	RS-232C	COM2	Wiring diagram 2 - COM2	
		LQE160 (CN1,CN2)				
		LQE560 (CN1,CN2)				
		LQE165 (CN1,CN2)	RS-422	COM1	Wiring diagram 2 - COM1	
LQE565 (CN1,CN2)						
HIDIC-S10/4 α	S10 4 α	LWE805	RS-422	COM1	Wiring diagram 1 - COM1	
HIDIC-S10V	LQP510	UP LINK	RS-422	COM1	Wiring diagram 2 - COM1	
		LQE560 (CN1,CN2)	RS-232C	COM2	Wiring diagram 2 - COM2	
		LQE565 (CN1,CN2)	RS-422	COM1	Wiring diagram 2 - COM1	

*1 For the ladder transfer function, see "Appendix 5 Ladder Transfer Function".

Ethernet Connection

PLC Selection on the Editor	CPU	Unit	TCP/IP	UDP/IP	Port No.	Ladder Transfer ^{*1}
HIDIC-S10/2 α , S10mini (Ethernet)	S10mini	LQE020	○	×	4301 (max. 4 units)	×
		LQE520				
HIDIC-S10V (Ethernet)	LQP510	LQE520				
		LQP520			4302 to 4305 (1 each)	

*1 For the ladder transfer function, see "Appendix 5 Ladder Transfer Function".

17.1.1 HIDIC-S10/2 α , S10mini

Communication Setting

Editor

Communication setting

(Underlined setting: default)

Item	Setting	Remarks
Connection Mode	<u>1:1</u> / Multi-link2	
Signal Level	RS-232C / <u>RS-422/485</u>	
Baud Rate	4800 / 9600 / <u>19200</u> / 38400 / 57600 / 115k bps	
Data Length	8 bits	
Stop Bit	1 bit	
Parity	Odd	

PLC

All PLC parameters are fixed to the following settings:

Baud rate: 19200 bps, data length: 8 bits, stop bit: 1 bit, parity: odd

However, when the optional RS-232C/RS-422 module is used, the channel and the protocol must be set using the channel No./protocol setting switch.

Channel No./Protocol Setting Switch

A maximum of two RS-232C/RS-422 modules (four channels) can be attached to one CPU. When using multiple channels, set a unique channel number (#1 to #4) for each.

LQE060

MODU NO	Communication Mode	Channel No.
8	H-7338 protocol	#0
9		#1

LQE160 / LQE165 / LQE560 / LQE565

MODU NO	Communication Mode	Channel No.
8	H-7338 protocol	#0
9		#1
A		#2
E		#3

Available Memory

The available memory setting range varies depending on the PLC model. Be sure to set within the range available for the PLC. Use [TYPE] when assigning the indirect memory for macro programs.

Memory	TYPE	Remarks
FW (work register)	00H	
X (input)	01H	XW as word device
Y (output)	02H	YW as word device
R (internal relay)	03H	RW as word device
G (global link relay)	04H	GW as word device
K (keep relay)	05H	KW as word device
T (on-delay timer/contact)	06H	TW as word device
U (one-shot timer/contact)	07H	UW as word device
C (up/down counter/contact)	08H	CW as word device
TS (on-delay timer/set value)	09H	
TC (on-delay timer/enumerated value)	0AH	
US (one-shot timer/set value)	0BH	
UC (one-shot timer/enumerated value)	0CH	
CS (up/down counter/set value)	0DH	
CC (up/down counter/enumerated value)	0EH	
DW (data register)	0FH	
E (event register)	10H	EW as word device
S (system register)	11H	SW as word device
J (transfer register)	12H	JW as word device
Q (receive register)	13H	QW as word device
M (extensional internal register)	14H	MW as word device

17.1.2 HIDIC-S10/2 α , S10mini (Ethernet)

Editor

Make the following settings on the editor. For more information, see "Appendix 2 Ethernet".

- IP address for the TS unit
- TS unit's port number in the [Communication Setting] tab window ([System Setting] → [Device Connection Setting])
- PLC's IP address and port number for [PLC Table] in the [Target Settings] tab window ([System Setting] → [Device Connection Setting] → [Target Settings])

PLC

LQE020

Module No. setting switch

MODU NO	Contents	
0	Communication via 10BASE-5	
2	Communication via 10BASE-T	

ET. NET system

Specify the IP address and the subnet mask.

LQE520

Module No. setting switch

MODU NO	Contents	
0	Communication via 10BASE-5	
2	Communication via 10BASE-T	

S10V ET.NET system

Specify the IP address and the subnet mask.

Available Memory

Memory	TYPE	Remarks
FW (work register)	00H	
X (input)	01H	XW as word device
Y (output)	02H	YW as word device
R (internal relay)	03H	RW as word device
G (global link relay)	04H	GW as word device
K (keep relay)	05H	KW as word device
T (on-delay timer/contact)	06H	TW as word device
U (one-shot timer/contact)	07H	UW as word device
C (up/down counter/contact)	08H	CW as word device
TS (on-delay timer/set value)	09H	
TC (on-delay timer/enumerated value)	0AH	
US (one-shot timer/set value)	0BH	
UC (one-shot timer/enumerated value)	0CH	
CS (up/down counter/set value)	0DH	
CC (up/down counter/enumerated value)	0EH	
DW (data register)	0FH	
E (event register)	10H	EW as word device
S (system register)	11H	SW as word device
J (transfer register)	12H	JW as word device
Q (receive register)	13H	QW as word device
M (extensional internal register)	14H	MW as word device

17.1.3 HIDIC-S10/4 α

Communication Setting

Editor

Communication setting

(Underlined setting: default)

Item	Setting	Remarks
Connection Mode	<u>1:1</u> / Multi-link2 / Multi-link2 (Ethernet)	
Signal Level	RS-232C / <u>RS-422/485</u>	
Baud Rate	19200 bps	
Data Length	8 bits	
Stop Bit	1 bit	
Parity	Odd	

PLC

All PLC parameters are fixed to the following settings:

Baud rate: 19200 bps, data length: 8 bits, stop bit: 1 bit, parity: odd

Only RS-422 (4-wire) connection can be used. For RS-232C or RS-485 (2-wire) connection, a commercially available converter must be used.

Available Memory

The available memory setting range varies depending on the PLC model. Be sure to set within the range available for the PLC. Use [TYPE] when assigning the indirect memory for macro programs.

Memory	TYPE	Remarks
FW (work register)	00H	
X (input)	01H	XW as word device
Y (output)	02H	YW as word device
R (internal relay)	03H	RW as word device
G (global link relay)	04H	GW as word device
K (keep relay)	05H	KW as word device
T (on-delay timer/contact)	06H	TW as word device
U (one-shot timer/contact)	07H	UW as word device
C (up/down counter/contact)	08H	CW as word device
TS (on-delay timer/set value)	09H	
TC (on-delay timer/enumerated value)	0AH	
US (one-shot timer/set value)	0BH	
UC (one-shot timer/enumerated value)	0CH	
CS (up/down counter/set value)	0DH	
CC (up/down counter/enumerated value)	0EH	
DW (data register)	0FH	
E (event register)	10H	EW as word device
S (system register)	11H	SW as word device
J (transfer register)	12H	JW as word device
Q (receive register)	13H	QW as word device
M (extensional internal register)	14H	MW as word device

17.1.4 HIDIC-S10V

Editor

Communication setting

(Underlined setting: default)

Item	Setting	Remarks
Connection Mode	<u>1:1</u> / Multi-link2	
Signal Level	RS-232C / <u>RS-422/485</u>	
Baud Rate	4800 / 9600 / <u>19200</u> / 38400 / 57600 / 115K bps	
Data Length	8 bits	
Stop Bit	1 bit	
Parity	Odd	

PLC

All PLC parameters are fixed to the following settings:

Baud rate: 19200 bps, data length: 8 bits, stop bit: 1 bit, parity: odd

However, when the optional RS-232C/RS-422 module is used, the channel and the protocol must be set using the channel No./protocol setting switch.

Channel No./Protocol Setting Switch

A maximum of two RS-232C/RS-422 modules (four channels) can be attached to one CPU. When using multiple channels, set a unique channel number (#1 to #4) for each.

LQE560 / LQE565

MODU NO	Communication Mode	Channel No.
8	H-7338 protocol	#0
9		#1
A		#2
E		#3

Available Memory

Memory	TYPE	Remarks
FW (work register)	00H	
X (input)	01H	XW as word device
Y (output)	02H	YW as word device
R (internal relay)	03H	RW as word device
G (global link relay)	04H	GW as word device
K (keep relay)	05H	KW as word device
T (on-delay timer/contact)	06H	TW as word device
U (one-shot timer/contact)	07H	UW as word device
C (up/down counter/contact)	08H	CW as word device
TS (on-delay timer/set value)	09H	
TC (on-delay timer/enumerated value)	0AH	
US (one-shot timer/set value)	0BH	
UC (one-shot timer/enumerated value)	0CH	
CS (up/down counter/set value)	0DH	
CC (up/down counter/enumerated value)	0EH	
DW (data register)	0FH	
E (event register)	10H	EW as word device
S (system register)	11H	SW as word device
J (transfer register)	12H	JW as word device
Q (receive register)	13H	QW as word device
M (extensional internal register)	14H	MW as word device
LB (work register)	15H	LBW as word device
LR (work register 1 for ladder converter)	16H	LRW as word device
LV (work register 2 for ladder converter)	17H	LVW as word device
LLL (long-word work register)	18H	Double-word
LFF (floating-point work register)	19H	
LWW (word work register)	1AH	
LML (long-word work register) backup area	1BH	Double-word
LGF (floating-point work register) backup area	1CH	
LXW (word work register) backup area	1DH	

17.1.5 HIDIC-S10V (Ethernet)

Editor

Make the following settings on the editor. For more information, see “Appendix 2 Ethernet”.

- IP address for the TS unit
- TS unit's port number in the [Communication Setting] tab window ([System Setting] → [Device Connection Setting])
- PLC's IP address and port number for [PLC Table] in the [Target Settings] tab window ([System Setting] → [Device Connection Setting] → [Target Settings])

PLC

LQE520

Module No. setting switch

MODU NO	Contents	Remarks
0	Communication via 10BASE-5	
2	Communication via 10BASE-T	

S10V ET.NET

Specify the IP address and the subnet mask.

LQP520

Station No. setting switch

S/T NO	Setting	Contents
U L	0 0	Set IP address is valid.
	F F	192.192.192.1 is valid.

Standard system tool

Specify the IP address and the subnet mask.

Available Memory

Memory	TYPE	Remarks
FW (work register)	00H	
X (input)	01H	XW as word device
Y (output)	02H	YW as word device
R (internal relay)	03H	RW as word device
G (global link relay)	04H	GW as word device
K (keep relay)	05H	KW as word device
T (on-delay timer/contact)	06H	TW as word device
U (one-shot timer/contact)	07H	UW as word device
C (up/down counter/contact)	08H	CW as word device
TS (on-delay timer/set value)	09H	
TC (on-delay timer/enumerated value)	0AH	
US (one-shot timer/set value)	0BH	
UC (one-shot timer/enumerated value)	0CH	
CS (up/down counter/set value)	0DH	
CC (up/down counter/enumerated value)	0EH	
DW (data register)	0FH	
E (event register)	10H	EW as word device
S (system register)	11H	SW as word device
J (transfer register)	12H	JW as word device
Q (receive register)	13H	QW as word device
M (extensional internal register)	14H	MW as word device
LB (work register)	15H	LBW as word device
LR (work register 1 for ladder converter)	16H	LRW as word device
LV (work register 2 for ladder converter)	17H	LVW as word device
LLL (long-word work register)	18H	Double-word
LFF (floating-point work register)	19H	
LWW (word work register)	1AH	
LML (long-word work register) backup area	1BH	Double-word
LGF (floating-point work register) backup area	1CH	
LXW (word work register) backup area	1DH	
A (extensional internal register)	1EH	AW as word device
N (nesting coil)	1FH	NW as word device
P (process coil)	20H	PW as word device
V (edge contact)	21H	VW as word device
Z (Z register)	22H	ZW as word device
IW (extensional input)	23H	
OW (extensional output)	24H	
BD (special internal register)	25H	

17.1.6 Wiring Diagrams

When Connected at COM1:

RS-422

Wiring diagram 1 - COM1

When connecting to the S10xα series, place a resistor of 50 Ω (1/2 W) as shown below.

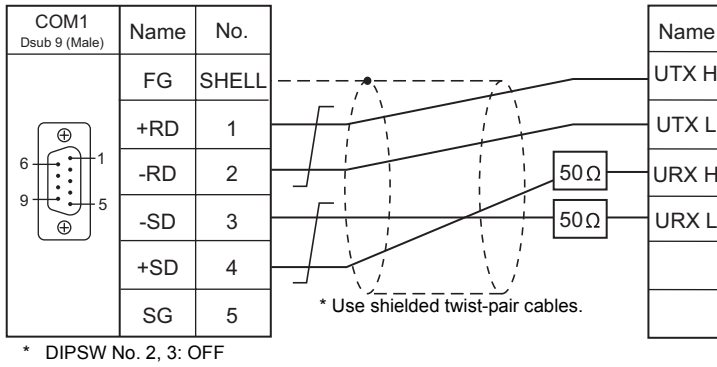

Wiring diagram 2 - COM1

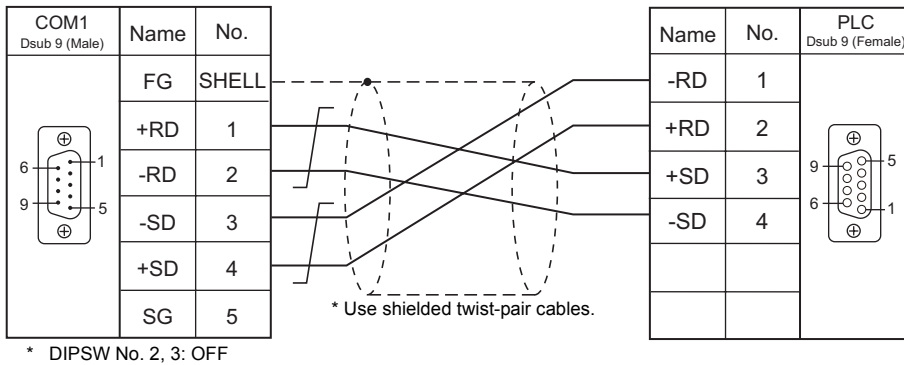

When Connected at COM2:

RS-232C

Wiring diagram 1 - COM2

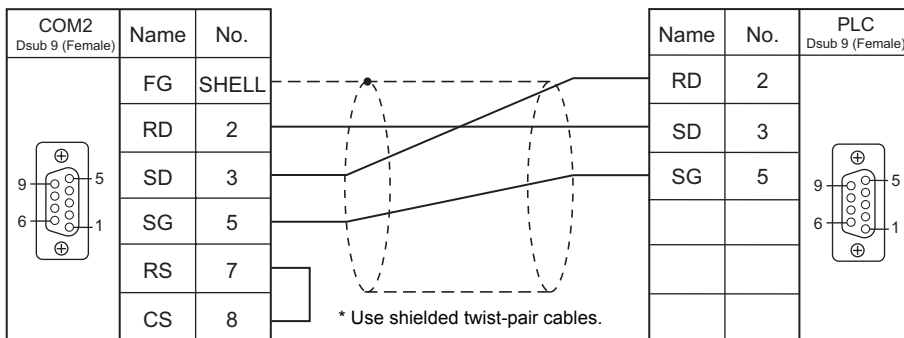

Wiring diagram 2 - COM2

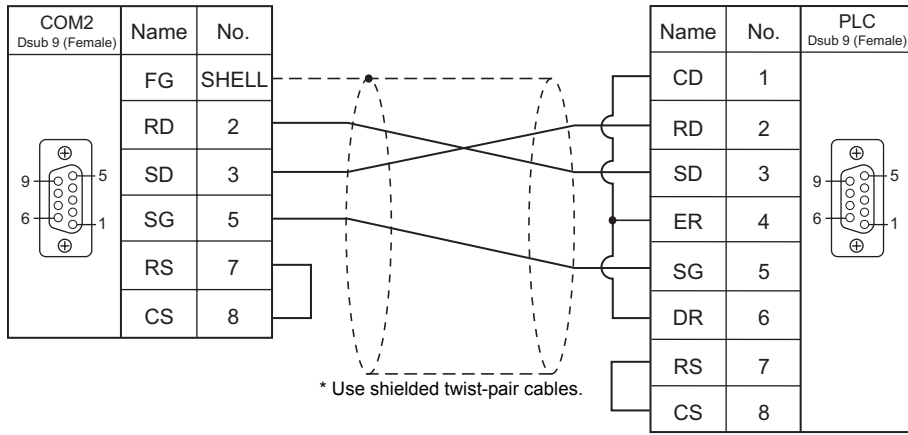

MEMO

Please use this page freely.

18. Hitachi Industrial Equipment Systems

18.1 PLC Connection

18.2 Temperature Controller/Servo/Inverter Connection

18.1 PLC Connection

Serial Connection

PLC Selection on the Editor	CPU	Unit/Port		Signal Level	TS Port	Connection	Ladder Transfer*4	
HIDIC-H	H series	COMM-2H		RS-232C	COM2	Hakko Electronics "D9-HI2-H-5M" + Gender changer	×	
				Wiring diagram 1 - COM2				
		PERIPHERAL on CPU		RS-422	COM1	Wiring diagram 1 - COM1		
				Wiring diagram 1 - COM1				
		PERIPHERAL1		RS-232C	COM2	Hakko Electronics "D9-HI2-H-5M" + Gender changer		
				Wiring diagram 1 - COM2				
		H252C CPU		PERIPHERAL2	RS-232C	COM2		Hakko Electronics "D9-HI2-H-5M" + Gender changer + Hitachi "CNCOM-05"
								Wiring diagram 1 - COM2 + Hitachi "CNCOM-05"
		EH-150	On CPU	PORT1	RS-232C	COM2		Wiring diagram 2 - COM2 ²
					RS-422	COM1		Wiring diagram 2 - COM1
				PORT2	RS-232C	COM2		Wiring diagram 2 - COM2 ²
					RS-422	COM3		Wiring diagram 1 - COM3 ³
	EH-SIO*1			PORT1	RS-232C	COM2		Wiring diagram 2 - COM2 ²
				PORT2	RS-232C	COM2		Wiring diagram 2 - COM2 ²
	MICRO-EH		On CPU		PORT1	RS-232C		COM2
				RS-422		COM1		Wiring diagram 4 - COM1
				COM3	Wiring diagram 3 - COM3 ³			
			EH-OB232	PORT2	RS-232C	COM2		Wiring diagram 2 - COM2 ²
					RS-422	COM1		Wiring diagram 5 - COM1
			EH-OB485	PORT2	RS-422	COM3		Wiring diagram 4 - COM3 ³
	COM3	Wiring diagram 5 - COM3 ³						
	Web controller	EH-WD10DR	SERIAL	RS-232C	COM2	Wiring diagram 3 - COM2		
				RS-422	COM1	Wiring diagram 6 - COM1		
		EH-WA23DR	SERIAL	RS-422	COM3	Wiring diagram 5 - COM3 ³		
COM3				Wiring diagram 5 - COM3 ³				
HIDIC-EHV	EH-150 EHV	EHV-CPU128	SERIAL	RS-232C	COM2	Wiring diagram 2 - COM2 ²		
				RS-422	COM1	Wiring diagram 5 - COM1		
			COM3	Wiring diagram 4 - COM3 ³				
		EH-SIO*1	PORT1	RS-232C	COM2	Wiring diagram 2 - COM2		
			PORT2	RS-422	COM1	Wiring diagram 3 - COM1		
		COM3		Wiring diagram 2 - COM3 ³				

*1 For the EH-SIO unit, EH-CPU548 (version E402 or later) and EH-CPU516 (version E202 or later) can only be used.

*2 Communication is also available using the Hitachi's "EH-RS05" cable with the cable used for the wiring diagram 1-COM2.

*3 Communication cannot be established when "transmission control protocol 1, without port" is set. Set "transmission control protocol 2, without port". Note that some CPUs do not support "transmission control protocol 2, without port". For more information, refer to the PLC manual issued by the manufacturer.

*4 For the ladder transfer function, see "Appendix 5 Ladder Transfer Function".

Ethernet Connection

PLC Selection on the Editor	CPU	Unit/Port	TCP/IP	UDP/IP	Port No.	Ladder Transfer *1
HIDIC-H (Ethernet)	H series	LAN-ETH2	×	○	3004 to 3005 (1 each)	×
	EH-150	EH-ETH			3004 to 3007 (1 each)	
	Web controller	ETHERNET				
HIDIC-EHV (Ethernet)	EHV-CPU128	ETHERNET				

*1 For the ladder transfer function, see "Appendix 5 Ladder Transfer Function".

18.1.1 HIDIC-H

Communication Setting

Editor

Communication setting

(Underlined setting: default)

Item	Setting	Remarks
Connection Mode	<u>1</u> : 1 / 1 : n / Multi-link / Multi-link2	
Baud Rate	4800 / 9600 / <u>19200</u> / 38400 / 57600 / 115K bps	
Parity	None / Odd / <u>Even</u>	
Signal Level	<u>RS-232C</u> / RS-422/485	
Data Length	<u>7</u> / 8 bits	
Stop Bit	<u>1</u> / 2 bits	
Target Port No.	0 to 31	
Transmission Mode	<u>Protocol 2 with port</u> Protocol 1 without port Protocol 2 without port Protocol 1 with port	Protocol 2 achieves higher communication speed, compared to protocol 1.

COMM-2H

ST No. switch

ST No.	Setting	Remarks
10 ¹ , 10 ⁰	0 to 31	If a value greater than 31 is set, the unit works as the station No. 31.

MODE switch

MODE	RS-232C	RS-422
0	Transmission control protocol 1 with port	-
2	Transmission control protocol 1 without port	Transmission control protocol 1 with port
7	Transmission control protocol 2 with port	-
9	Transmission control protocol 2 without port	Transmission control protocol 2 with port

* When connecting to both RS-232C and RS-422, set MODE switch to 9.

DIP switch

Switch	Setting	Contents
1	OFF	Bit length 7
2	OFF	19200 bps
3	ON	
4	ON	
5	ON	With parity
6	ON	Even
7	OFF	Stop bit 1
8	ON	With sumcheck

PERIPHERAL Port

No particular setting is necessary on the PLC. The PLC always operates using the parameter shown below. Set the following parameter on TS.

Item	Setting	Remarks
Signal Level	RS-232C	
Baud Rate	19200 bps	
Data Length	7 bits	ASCII
Stop Bit	1 bit	
Parity	Even	
Transmission Mode	Protocol 1 without port	
Sum Check	Provided	
Port Operation	Dedicated port	

EH-150 CPU

PORT1

Set the signal level and the communication protocol as shown below for PORT1 (dedicated port). Other parameters (7 bits, 1 bit, even) are fixed.

Signal Level	Communication Protocol	CPU Model
RS-232C	Transmission control protocol 1	EH-CPU104/104A/208/208A/308/308A/316/316A/448/448A/516/548
	Transmission control protocol 2	EH-CPU104A/208A/308A/316A/448/448A/516/548
RS-422	Transmission control protocol 1	EH-CPU308A/316A/448/448A/516/548
	Transmission control protocol 2	
	Transmission control protocol 1 with port	
	Transmission control protocol 2 with port	
RS-485	Transmission control protocol 1 with port	
	Transmission control protocol 2 with port	

Procedure

1. Turn the PLC off and set the "Mode setting switch" (page 18-3).
2. Turn the power on and check the value for "Special internal output: WRF037" (page 18-4).
3. When the signal level and the communication control protocol have correctly been selected, setting is completed. If they are wrong, set a correct value and turn the power off and back on again.
4. Check the value set for WRF037.

Mode setting switch

SW3	SW4	SW5	Contents
ON	ON	ON	Dedicated port, 4,800 bps
OFF	ON		Dedicated port, 9,600 bps
ON	OFF		Dedicated port, 19,200 bps
OFF	OFF		Dedicated port, 38,400 bps

Special internal output: WRF037

Memory	Setting																																																														
WRF037	<div style="text-align: center;"> <table border="1" style="margin: 0 auto; border-collapse: collapse;"> <tr> <td style="width: 15px;">15</td><td style="width: 15px;">14</td><td style="width: 15px;">13</td><td style="width: 15px;">12</td><td style="width: 15px;">11</td><td style="width: 15px;">10</td><td style="width: 15px;">9</td><td style="width: 15px;">8</td><td style="width: 15px;">7</td><td style="width: 15px;">6</td><td style="width: 15px;">5</td><td style="width: 15px;">4</td><td style="width: 15px;">3</td><td style="width: 15px;">2</td><td style="width: 15px;">1</td><td style="width: 15px;">0</td> </tr> <tr> <td style="text-align: center;">a</td><td style="text-align: center;">b</td><td style="text-align: center;">c</td><td style="text-align: center;">d</td><td style="text-align: center;">e</td><td style="text-align: center;">f</td><td style="text-align: center;">g</td><td style="text-align: center;">h</td><td colspan="8" style="text-align: center;">Station number 00 to 31 (BCD)</td> </tr> </table> </div> <div style="margin-top: 10px;"> <p>Communication interface setting (to be set by user)</p> <table border="1" style="margin: 0 auto; border-collapse: collapse;"> <thead> <tr style="background-color: #e6e6fa;"> <th style="width: 15px;">g</th><th style="width: 15px;">h</th><th style="width: 100px;">Interface</th></tr> </thead> <tbody> <tr><td style="text-align: center;">0</td><td style="text-align: center;">0</td><td>RS-232C</td></tr> <tr><td style="text-align: center;">0</td><td style="text-align: center;">1</td><td>RS-422</td></tr> <tr><td style="text-align: center;">1</td><td style="text-align: center;">0</td><td>RS-485</td></tr> <tr><td style="text-align: center;">1</td><td style="text-align: center;">1</td><td>Not to be changed</td></tr> </tbody> </table> </div> <div style="margin-top: 10px;"> <p>Communication interface status display (to be set by system)</p> <table border="1" style="margin: 0 auto; border-collapse: collapse;"> <thead> <tr style="background-color: #e6e6fa;"> <th style="width: 15px;">e</th><th style="width: 15px;">f</th><th style="width: 100px;">Interface</th></tr> </thead> <tbody> <tr><td style="text-align: center;">0</td><td style="text-align: center;">0</td><td>RS-232C</td></tr> <tr><td style="text-align: center;">0</td><td style="text-align: center;">1</td><td>RS-422</td></tr> <tr><td style="text-align: center;">1</td><td style="text-align: center;">0</td><td>RS-485</td></tr> <tr><td style="text-align: center;">1</td><td style="text-align: center;">1</td><td>-</td></tr> </tbody> </table> </div> <div style="margin-top: 10px;"> <p>Built-in terminating resistance 0: None 1: Provided</p> </div> <div style="margin-top: 10px;"> <p>Station number 0: Without station number 1: With station number</p> </div> <div style="margin-top: 10px;"> <p>Transmission control protocol 0: Transmission control protocol 1 1: Transmission control protocol 2</p> </div> <div style="margin-top: 10px;"> <p>Bit setting 1: Set (when setting has been completed, the system sets this value to "0".)</p> </div>	15	14	13	12	11	10	9	8	7	6	5	4	3	2	1	0	a	b	c	d	e	f	g	h	Station number 00 to 31 (BCD)								g	h	Interface	0	0	RS-232C	0	1	RS-422	1	0	RS-485	1	1	Not to be changed	e	f	Interface	0	0	RS-232C	0	1	RS-422	1	0	RS-485	1	1	-
15	14	13	12	11	10	9	8	7	6	5	4	3	2	1	0																																																
a	b	c	d	e	f	g	h	Station number 00 to 31 (BCD)																																																							
g	h	Interface																																																													
0	0	RS-232C																																																													
0	1	RS-422																																																													
1	0	RS-485																																																													
1	1	Not to be changed																																																													
e	f	Interface																																																													
0	0	RS-232C																																																													
0	1	RS-422																																																													
1	0	RS-485																																																													
1	1	-																																																													
	<p>Setting example</p> <table border="1" style="width:100%; border-collapse: collapse; text-align: center;"> <thead> <tr style="background-color: #e6e6fa;"> <th>User Setting</th><th>After Turning the Power Back ON</th><th>Signal Level</th><th>Communication Control Protocol</th></tr> </thead> <tbody> <tr> <td>H8000</td><td>H0000</td><td rowspan="2">RS-232C</td><td>Transmission control protocol 1</td></tr> <tr> <td>HC000</td><td>H4000</td><td>Transmission control protocol 2</td></tr> <tr> <td>H8100 (H9100)</td><td>H0500 (H1500)</td><td rowspan="4">RS-422</td><td>Transmission control protocol 1</td></tr> <tr> <td>HC100 (HD100)</td><td>H4500 (H5500)</td><td>Transmission control protocol 2</td></tr> <tr> <td>HA1** (HB1**)</td><td>H25** (H35**)</td><td>Transmission control protocol 1 with port</td></tr> <tr> <td>HE1** (HF1**)</td><td>H65** (H75**)</td><td>Transmission control protocol 2 with port</td></tr> <tr> <td>HA2** (HB2**)</td><td>H2A** (H3A**)</td><td rowspan="2">RS-485</td><td>Transmission control protocol 1 with port</td></tr> <tr> <td>HE2** (HF2**)</td><td>H6A** (H7A**)</td><td>Transmission control protocol 2 with port</td></tr> </tbody> </table> <p style="font-size: small; margin-top: 5px;">Inside the parentheses () shows cases where the terminating resistance is provided.</p>	User Setting	After Turning the Power Back ON	Signal Level	Communication Control Protocol	H8000	H0000	RS-232C	Transmission control protocol 1	HC000	H4000	Transmission control protocol 2	H8100 (H9100)	H0500 (H1500)	RS-422	Transmission control protocol 1	HC100 (HD100)	H4500 (H5500)	Transmission control protocol 2	HA1** (HB1**)	H25** (H35**)	Transmission control protocol 1 with port	HE1** (HF1**)	H65** (H75**)	Transmission control protocol 2 with port	HA2** (HB2**)	H2A** (H3A**)	RS-485	Transmission control protocol 1 with port	HE2** (HF2**)	H6A** (H7A**)	Transmission control protocol 2 with port																															
User Setting	After Turning the Power Back ON	Signal Level	Communication Control Protocol																																																												
H8000	H0000	RS-232C	Transmission control protocol 1																																																												
HC000	H4000		Transmission control protocol 2																																																												
H8100 (H9100)	H0500 (H1500)	RS-422	Transmission control protocol 1																																																												
HC100 (HD100)	H4500 (H5500)		Transmission control protocol 2																																																												
HA1** (HB1**)	H25** (H35**)		Transmission control protocol 1 with port																																																												
HE1** (HF1**)	H65** (H75**)		Transmission control protocol 2 with port																																																												
HA2** (HB2**)	H2A** (H3A**)	RS-485	Transmission control protocol 1 with port																																																												
HE2** (HF2**)	H6A** (H7A**)		Transmission control protocol 2 with port																																																												

* If the setting is undefined upon power-up, the default setting (transmission control protocol 1, without port, RS-232C) is applied.

PORT2

PORT2 settings are defined as "dedicated port, RS-232C, transmission control protocol 1, 7 bits, 1 bit, even", regardless of the CPU model.

Mode setting switch, PHL switch

SW6	PHL Switch	Baud Rate	Remarks
OFF	OFF (Low)	4800 bps	PHL signal (pin 4 at PORT2) Low
ON	OFF (Low)	9600 bps	
OFF	ON (High)	19200 bps	PHL signal (pin 4 at PORT2) High
ON	ON (High)	38400 bps	

EH-SIO

PORT1/PORT2

The following table shows the signal level and the communication protocol for each port. Other parameters (7 bits, 1 bit, even) are fixed.

Port	Signal Level	Communication Protocol	EH-SIO Version
PORT1	RS-232C	Transmission control protocol 1	Version 2.0 and later
		Transmission control protocol 2	Version 2.1 and later
PORT2	RS-232C	Transmission control protocol 1	Version 2.0 and later
		Transmission control protocol 2	Version 2.1 and later
	RS-422	Transmission control protocol 1	Version 2.0 and later
		Transmission control protocol 2	Version 2.1 and later
		Transmission control protocol 1 with port	Version 2.0 and later
		Transmission control protocol 2 with port	Version 2.1 and later
	RS-485	Transmission control protocol 2	Version 2.1 and later
		Transmission control protocol 1 with port	Version 2.0 and later
Transmission control protocol 2 with port		Version 2.1 and later	

DIP switch 1/2

Set the baud rate for PORT1/2 using the DIPSW1/2 attached to the side of EH-SIO. For more information, refer to the PLC manual issued by the manufacturer.

Ladder program

Make initial settings for the transmission control protocol and the station number. For more information, refer to the PLC manual issued by the manufacturer.

MICRO EH

The following table shows the signal level and the communication protocol for each port. Other parameters (7 bits, 1 bit, even) are fixed.

CPU Model	Port	Signal Level	Communication Protocol
EH-D10 EH-D14 / EH-A14 EH-D20 / EH-A20 EH-D23 / EH-A23 EH-D28 / EH-A28 EH-D40 / EH-A40 EH-D64 / EH-A64	PORT1	RS-232C	Transmission control protocol 1
			Transmission control protocol 2
EH-D23 / EH-A23 EH-D28 / EH-A28	PORT2	RS-422	Transmission control protocol 1
			Transmission control protocol 2
			Transmission control protocol 1 with port
			Transmission control protocol 2 with port
EH-x64xxx + EH-OB232	PORT2	RS-232C	Transmission control protocol 1
			Transmission control protocol 2
EH-x64xxx + EH-OB485		RS-422	Transmission control protocol 1
			Transmission control protocol 2
			Transmission control protocol 1 with port
			Transmission control protocol 2 with port

PORT1

Procedure

1. Turn the PLC off and set the baud rate using the DIPSW.
2. Turn the power on and check the value set for "Special internal output: WRF01A".
3. When the transmission control protocol has correctly been selected, setting is completed. If it is wrong, set a correct value.
4. Set the bit "R7F6" (setting write request) to save the setting in the flash memory.

* It is not necessary to make the setting again upon next power-up once the setting has been saved in the flash memory. Note that the ladder tool cannot be connected when the setting has been saved using the transmission control protocol 2.

DIPSW

SW1	SW2	SW3	SW4	Baud Rate
ON	OFF	ON	OFF	38.4 kbps
ON	OFF	OFF	OFF	19.2 kbps
OFF	OFF	ON	OFF	9600 bps
OFF	OFF	OFF	OFF	4800 bps

Special internal output: WRF01A

Memory	Setting	Contents
WRF01A	H0000	Transmission control protocol 1
	H8000	Transmission control protocol 2

PORT2

Procedure

1. Check the value set for special internal output "WRF03D".
2. When the setting, such as transmission control protocol or baud rate, has correctly been defined, the setting is completed. If it is wrong, set a correct value. See "User Setting" described in "Special internal output: WRF03D".
3. Check that the value set for WRF03D has been changed to the one shown in the "System Setting" column.
4. Set the bit "R7F6" (setting write request) to save the setting in the flash memory.

* It is not necessary to make the setting again upon next power-up once the setting has been saved in the flash memory.

Special internal output: WRF03D

Memory	Setting																	
WRF03D																		
	<table border="1"> <thead> <tr> <th>d</th> <th>Baud Rate</th> </tr> </thead> <tbody> <tr> <td>00000</td> <td>4800 bps</td> </tr> <tr> <td>00001</td> <td>9600 bps</td> </tr> <tr> <td>00010</td> <td>19.2 kbps</td> </tr> <tr> <td>00011</td> <td>38.4 kbps</td> </tr> </tbody> </table> <p>Station number 0: Without station number 1: With station number</p> <p>Transmission control protocol 0: Transmission control protocol 1 1: Transmission control protocol 2</p> <p>Bit setting 1: Set (when setting completed, the system sets this value to "0".)</p>	d	Baud Rate	00000	4800 bps	00001	9600 bps	00010	19.2 kbps	00011	38.4 kbps							
d	Baud Rate																	
00000	4800 bps																	
00001	9600 bps																	
00010	19.2 kbps																	
00011	38.4 kbps																	
	<p>Setting example</p> <table border="1"> <thead> <tr> <th>User Setting</th> <th>System Setting</th> <th>Interface</th> <th>Baud Rate</th> </tr> </thead> <tbody> <tr> <td>H8300</td> <td>H0300</td> <td>Transmission control protocol 1</td> <td rowspan="4">38.4 kbps</td> </tr> <tr> <td>HC300</td> <td>H4300</td> <td>Transmission control protocol 2</td> </tr> <tr> <td>HA300</td> <td>H2300</td> <td>Transmission control protocol 1 with port</td> </tr> <tr> <td>HE300</td> <td>H6300</td> <td>Transmission control protocol 2 with port</td> </tr> </tbody> </table>	User Setting	System Setting	Interface	Baud Rate	H8300	H0300	Transmission control protocol 1	38.4 kbps	HC300	H4300	Transmission control protocol 2	HA300	H2300	Transmission control protocol 1 with port	HE300	H6300	Transmission control protocol 2 with port
User Setting	System Setting	Interface	Baud Rate															
H8300	H0300	Transmission control protocol 1	38.4 kbps															
HC300	H4300	Transmission control protocol 2																
HA300	H2300	Transmission control protocol 1 with port																
HE300	H6300	Transmission control protocol 2 with port																

Web Controller

The following table shows the signal level and the communication protocol for each PLC. Other parameters (7 bits, 1 bit, even) are fixed.

PLC	Port	Signal Level	Communication Protocol
EH-WD10DR	SERIAL	RS-232C	Transmission control protocol 1
			Transmission control protocol 2
EH-WA23DR	PORT1	RS-232C	Transmission control protocol 1
			Transmission control protocol 2
		RS-422	Transmission control protocol 1
			Transmission control protocol 2
			Transmission control protocol 1 with port
			Transmission control protocol 2 with port
		RS-485	Transmission control protocol 2
			Transmission control protocol 1 with port
	Transmission control protocol 2 with port		

Procedure

Connect the computer (PC) to the web controller and make the setting for the PLC with the web browser. For more information, refer to the PLC manual issued by the manufacturer.

System configuration (RS-232C protocol/serial protocol → passive HI protocol)

Make settings for "Interface Type", "Transmission Control Procedure", "Transmission Speed".

Available Memory

The available memory setting range varies depending on the PLC model. Be sure to set within the range available for the PLC. Use [TYPE] when assigning the indirect memory for macro programs.

Memory	TYPE	Remarks
WR (internal output/word)	00H	
X (external input)	01H	WX as word device
Y (external output)	02H	WY as word device
L (CPU link area)	03H	WL as word device
M (data area)	04H	WM as word device
TC (timer, counter/elapsed time)	05H	
R (internal output/bit)	06H	
TD (timer, counter/contact)	07H	
WN (network input/output)	08H	

18.1.2 HIDIC-H (Ethernet)

Communication Setting

Editor

Make the following settings on the editor. For more information, see “Appendix 2 Ethernet”.

- IP address for the TS unit
- TS unit's port number in the [Communication Setting] tab window ([System Setting] → [Device Connection Setting])
- PLC's IP address and port number for [PLC Table] in the [Target Settings] tab window ([System Setting] → [Device Connection Setting] → [Target Settings])

LAN-ETH2 (H Series)

The IP address setting tool can be downloaded from the Hitachi Industrial Equipment Systems website. Connect the computer (PC) to the RS-232C port of PORT1 and specify the IP address and the task port. For more information, refer to the PLC manual issued by the manufacturer.

EH-ETH (EH-150)

Make settings using the web server function incorporated in EH-ETH. For more information, refer to the PLC manual issued by the manufacturer.

IP address information setup

Set the IP address and the subnet mask.

Task code information setup

Select [UDP/IP] for [Protocol] and specify the port number.

Web Controller

Connect the computer (PC) to the web controller and make the setting for the PLC with the web browser. For more information, refer to the PLC manual issued by the manufacturer.

System configuration (IP address)

Specify the IP address and the subnet mask.

System configuration (ethernet protocol → passive HI protocol)

Select [UDP/IP] for [Task code port] and specify the port number.

Available Memory

The available memory setting range varies depending on the PLC model. Be sure to set within the range available for the PLC. Use [TYPE] when assigning the indirect memory for macro programs.

Memory	TYPE	Remarks
WR (internal output/word)	00H	
X (external input)	01H	WX as word device
Y (external output)	02H	WY as word device
L (CPU link area)	03H	WL as word device
M (data area)	04H	WM as word device
TC (timer, counter/elapsed time)	05H	
R (internal output/bit)	06H	
TD (timer, counter/contact)	07H	
WN (network input/output)	08H	

18.1.3 HIDIC-EHV

Communication Setting

Editor

Communication setting

(Underlined setting: default)

Item	Setting	Remarks
Connection Mode	<u>1:1</u> / 1:n / Multi-link / Multi-link2	
Signal Level	<u>RS-232C</u> / RS-422/485	
Baud Rate	4800 / 9600 / 19200 / <u>38400</u> / 57600 bps	
Data Length	7 bits	
Stop Bit	1 bit	
Parity	Even	
Target Port No.	0 to 31	
Transmission Mode	<u>Protocol 2 with port</u> Protocol 1 without port Protocol 2 without port Protocol 1 with port	Protocol 2 achieves higher communication speed, compared to protocol 1.

EHV-CPU

CPU communication setting on control editor

Item	Setting														
Serial communication setting	Dedicated														
Port type	RS-232C/RS-422/RS-485 The following table shows the combination of port type and communication protocols available. <table border="1" style="margin-left: 40px;"> <thead> <tr> <th>Port Type</th> <th>Communication Protocol</th> </tr> </thead> <tbody> <tr> <td rowspan="2">RS-232C</td> <td>Transmission control protocol 1 (1 : 1)</td> </tr> <tr> <td>Transmission control protocol 2 (1 : 1)</td> </tr> <tr> <td rowspan="4">RS-422</td> <td>Transmission control protocol 1 (1 : 1)</td> </tr> <tr> <td>Transmission control protocol 2 (1 : 1)</td> </tr> <tr> <td>Transmission control protocol 1 (1 : n)</td> </tr> <tr> <td>Transmission control protocol 2 (1 : n)</td> </tr> <tr> <td rowspan="3">RS-485</td> <td>Transmission control protocol 2 (1 : 1)</td> </tr> <tr> <td>Transmission control protocol 1 (1 : n)</td> </tr> <tr> <td>Transmission control protocol 2 (1 : n)</td> </tr> </tbody> </table>	Port Type	Communication Protocol	RS-232C	Transmission control protocol 1 (1 : 1)	Transmission control protocol 2 (1 : 1)	RS-422	Transmission control protocol 1 (1 : 1)	Transmission control protocol 2 (1 : 1)	Transmission control protocol 1 (1 : n)	Transmission control protocol 2 (1 : n)	RS-485	Transmission control protocol 2 (1 : 1)	Transmission control protocol 1 (1 : n)	Transmission control protocol 2 (1 : n)
Port Type	Communication Protocol														
RS-232C	Transmission control protocol 1 (1 : 1)														
	Transmission control protocol 2 (1 : 1)														
RS-422	Transmission control protocol 1 (1 : 1)														
	Transmission control protocol 2 (1 : 1)														
	Transmission control protocol 1 (1 : n)														
	Transmission control protocol 2 (1 : n)														
RS-485	Transmission control protocol 2 (1 : 1)														
	Transmission control protocol 1 (1 : n)														
	Transmission control protocol 2 (1 : n)														
Baud rate	4800 / 9600 / 19200 / <u>38400</u> / 57600 bps														
Communication protocol	See "Port Type" shown above.														
Station number	0 to 31 (to be specified when "with port" is selected)														

EH-SIO

PORT1/PORT2

The following table shows the signal level and the communication protocol for each port. Other parameters (7 bits, 1 bit, even) are fixed.

Port	Signal Level	Communication Protocol	EH-SIO Version
PORT1	RS-232C	Transmission control protocol 1	Version 2.0 and later
		Transmission control protocol 2	Version 2.1 and later
PORT2	RS-232C	Transmission control protocol 1	Version 2.0 and later
		Transmission control protocol 2	Version 2.1 and later
	RS-422	Transmission control protocol 1	Version 2.0 and later
		Transmission control protocol 2	Version 2.1 and later
		Transmission control protocol 1 with port	Version 2.0 and later
		Transmission control protocol 2 with port	Version 2.1 and later
	RS-485	Transmission control protocol 2	Version 2.1 and later
		Transmission control protocol 1 with port	Version 2.0 and later
Transmission control protocol 2 with port		Version 2.1 and later	

DIP switch 1/2

Set the baud rate for PORT1/2 using the DIPSW1/2 attached to the side of EH-SIO. For more information, refer to the PLC manual issued by the manufacturer.

Ladder program

Make initial settings for the transmission control protocol and the station number. For more information, refer to the PLC manual issued by the manufacturer.

Available Memory

Memory	TYPE	Remarks
WR (internal output/word)	00H	
X (external input)	01H	WX as word device
Y (external output)	02H	WY as word device
L (CPU link area)	03H	WL as word device
M (data area)	04H	WM as word device
TC (timer, counter/elapsed time)	05H	
R (internal output/bit)	06H	
TD (timer, counter/contact)	07H	
WN (network input/output)	08H	
CL (counter clear)	09H	
EX (extensional external input)	0BH	WEX as word device
EY (extensional external output)	0CH	WEY as word device

18.1.4 HIDIC-EHV (Ethernet)

Communication Setting

Editor

Make the following settings on the editor. For more information, see “Appendix 2 Ethernet”.

- IP address for the TS unit
- TS unit's port number in the [Communication Setting] tab window ([System Setting] → [Device Connection Setting])
- PLC's IP address and port number for [PLC Table] in the [Target Settings] tab window ([System Setting] → [Device Connection Setting] → [Target Settings])

PLC

Control Editor

IP address setting

Item	Contents	
IP address	Specify the IP address for the PLC.	
Subnet mask	Specify the subnet mask for the PLC.	
Default gateway	Specify according to the environment.	

Ethernet communication (task code) setting

Item	Contents	
Valid	Select a port to which the TS unit is connected and make the port enabled.	
Port No.	Set the port number of the PLC.	
Protocol	UDP/IP	

Available Memory

Memory	TYPE	Remarks
WR (internal output/word)	00H	
X (external input)	01H	WX as word device
Y (external output)	02H	WY as word device
L (CPU link area)	03H	WL as word device
M (data area)	04H	WM as word device
TC (timer, counter/elapsed time)	05H	
R (internal output/bit)	06H	
TD (timer, counter/contact)	07H	
WN (network input/output)	08H	
CL (counter clear)	09H	
EX (extensional external input)	0BH	WEX as word device
EY (extensional external output)	0CH	WEY as word device

18.1.5 Wiring Diagrams

When Connected at COM1:

RS-422

Wiring diagram 1 - COM1

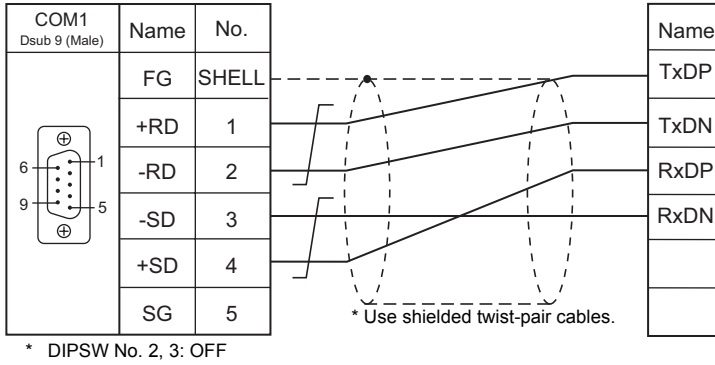

Wiring diagram 2 - COM1

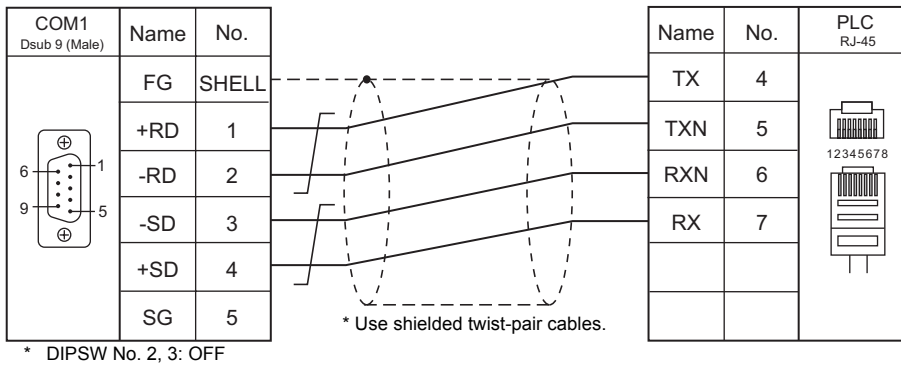

Wiring diagram 3 - COM1

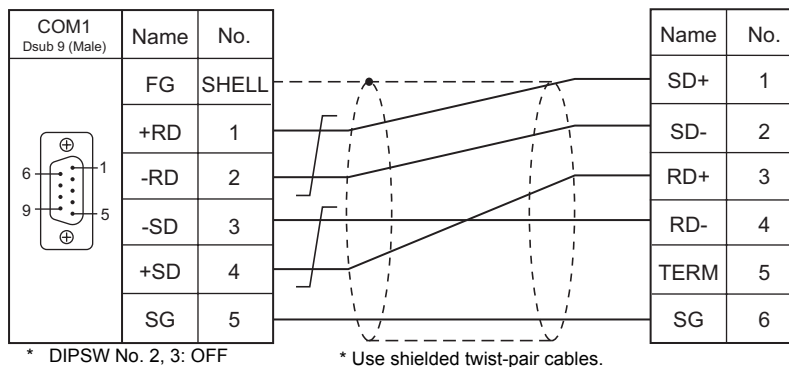

Wiring diagram 4 - COM1

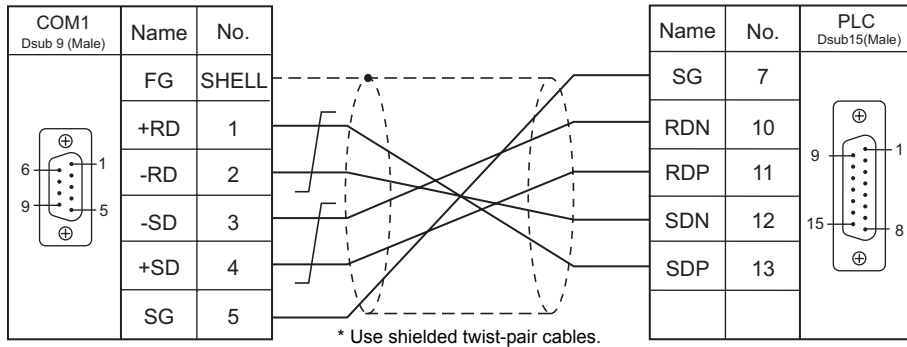

* DIPSW No. 2, 3: OFF

Wiring diagram 5 - COM1

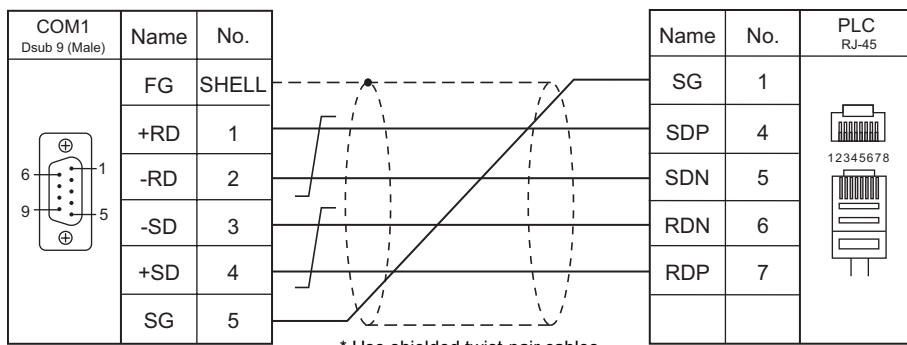

* DIPSW No. 2, 3: OFF

Wiring diagram 6 - COM1

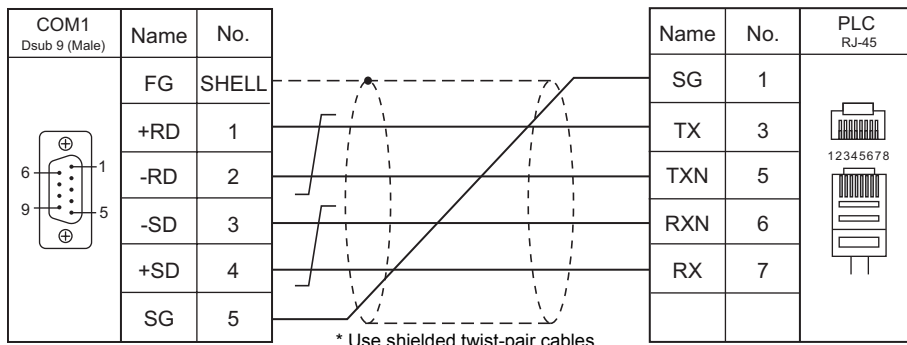

* DIPSW No. 2, 3: OFF

When Connected at COM2:

RS-232C

Wiring diagram 1 - COM2

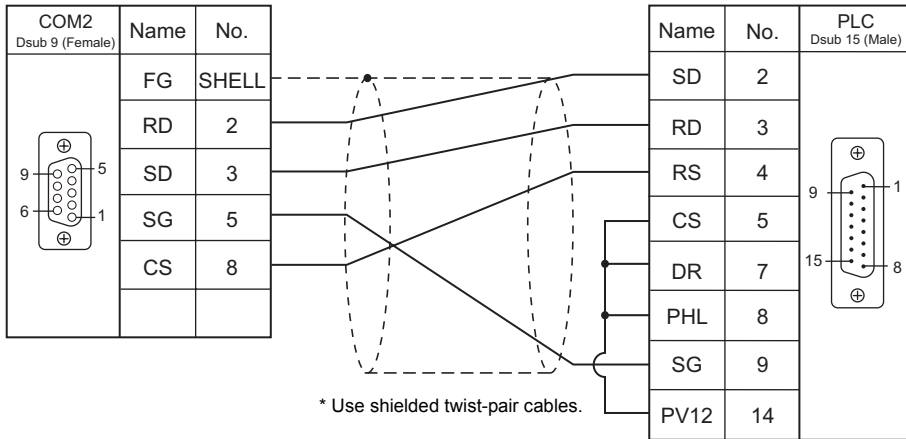

Wiring diagram 2 - COM2

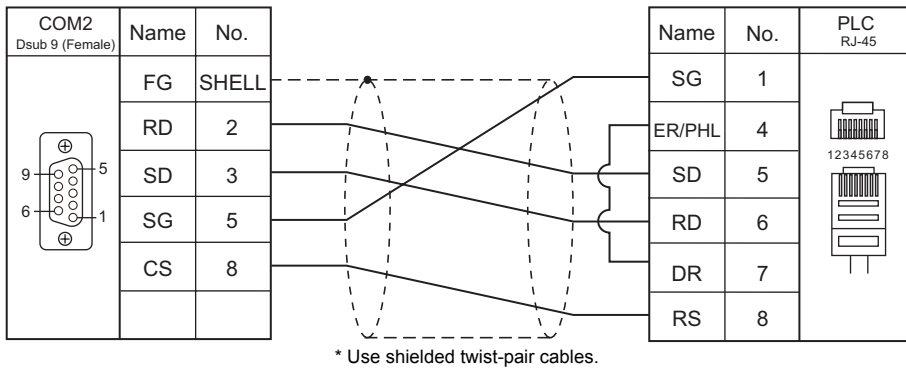

Wiring diagram 3 - COM2

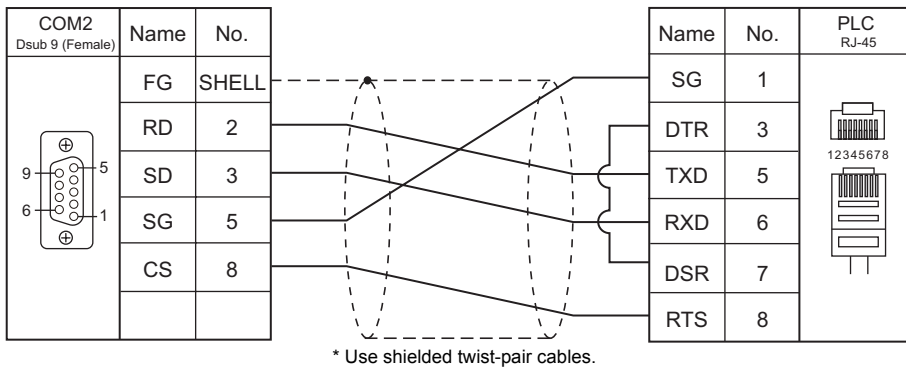

When Connected at COM3:

RS-485

Wiring diagram 1 - COM3

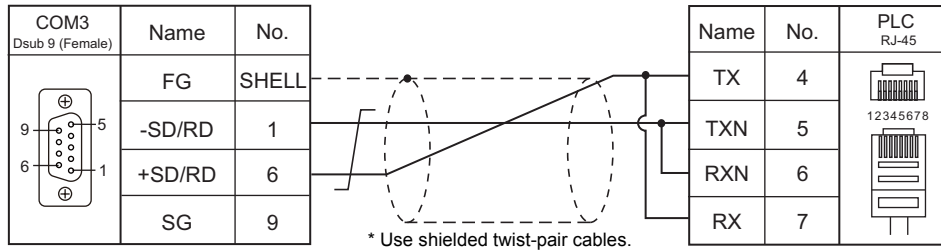

Wiring diagram 2 - COM3

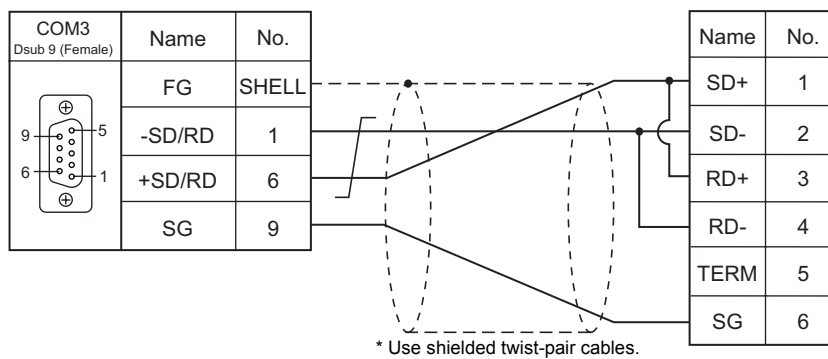

Wiring diagram 3 - COM3

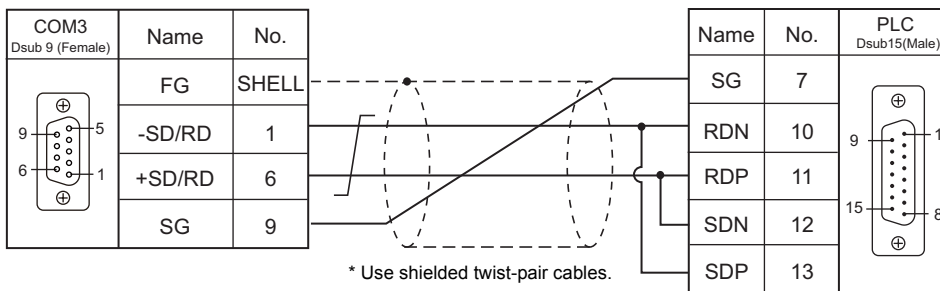

Wiring diagram 4 - COM3

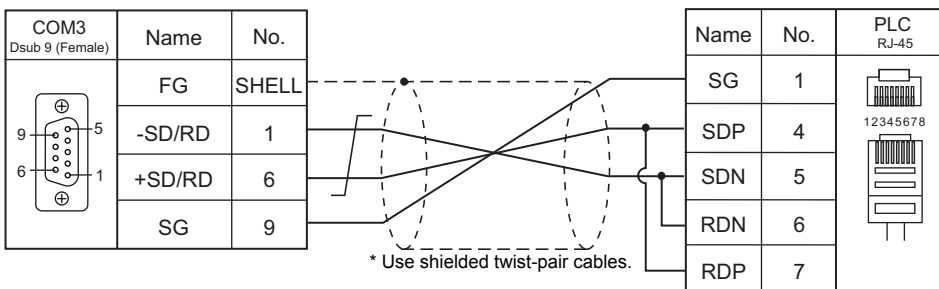

Wiring diagram 5 - COM3

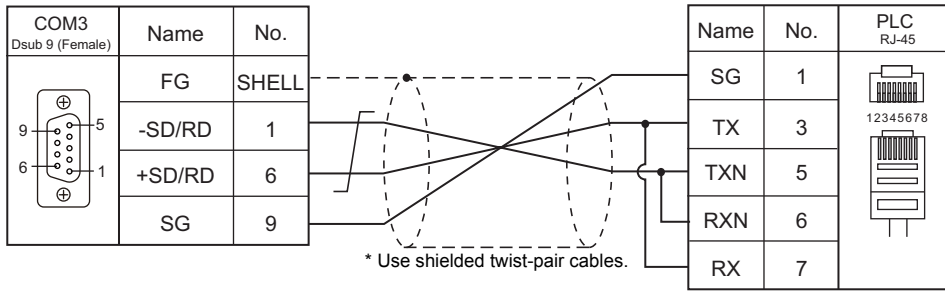

18.2 Temperature Controller/Servo/Inverter Connection

The controller models shown below can be connected.

Inverter

PLC Selection on the Editor	Model	Port	Signal Level	TS Port	Connection	Lst File
SJ300 series	SJ300 SJH300	TM2	RS-485	COM1	Wiring diagram 1 - COM1	H_SJ300.Lst
				COM3	Wiring diagram 1 - COM3	
SJ700 series	SJ700 SJ700-2	TM2	RS-485	COM1	Wiring diagram 1 - COM1	H_SJ700.Lst
				COM3	Wiring diagram 1 - COM3	

18.2.1 SJ300 Series

Communication Setting

Editor

Communication setting

(Underlined setting: default)

Item	Setting	Remarks
Connection Mode	1 : 1 / <u>1:n</u> / Multi-link2 / Multi-link2 (Ethernet)	
Signal Level	RS-232C / <u>RS-422/485</u>	
Baud Rate	<u>4800</u> / 9600 / 19200 bps	
Data Length	<u>7</u> / 8 bits	
Stop Bit	<u>1</u> / 2 bits	
Parity	<u>None</u> / Odd / Even	
Target Port No.	<u>1</u> to 32	

Inverter

Parameter

The communication parameters can be set using keys attached to the inverter.

Be sure to match the settings to those made on the [Communication Setting] tab window of the editor.

(Underlined setting: default)

Function Code	Function Name	Setting	Remarks	
Basic setting	A001	Frequency command selection	03: RS-485	To give the frequency command from TS, always select "03".
	A002	Operation command selection	03: RS-485	To give the operation command from TS, always select "03".
Communication function adjustment	C070	Data command selection	03: RS-485	
	C071	Baud rate selection	<u>04: 4800 bps</u> 05: 9600 bps 06: 19200 bps	
	C072	Communication station number selection	<u>1</u> . to 32.	
	C073	Communication bit length selection	<u>7: 7 bits</u> 8: 8 bits	
	C074	Communication parity selection	<u>00: No parity</u> 01: Even parity 02: Odd parity	
	C075	Communication stop bit selection	<u>1: 1 bit</u> 2: 2 bits	
C078	Communication latency	<u>0</u> . to 1000. (msec)		

Terminating resistance

Short-circuit RP-SN (control terminal block) on the terminal inverter.

Available Memory

The available memory setting range varies depending on the device. Be sure to set within the range available with the device to be used. Use [TYPE] when assigning the indirect memory for macro programs.

Memory	TYPE	Remarks
d	00H	Double-word, read only
F	01H	Double-word
A	02H	Double-word
b	03H	Double-word
C	04H	Double-word
H	05H	Double-word
P	06H	Double-word
T (trip history)	07H	Double-word, read only

Indirect Memory Designation

	15	8 7	0
n + 0	Models (11 to 18)		Memory type
n + 1	Address No.		
n + 2	Expansion code *		Bit designation
n + 3	00		Station number

* In the expansion code, set which word, higher or lower, is to be read when a double-word address is specified.

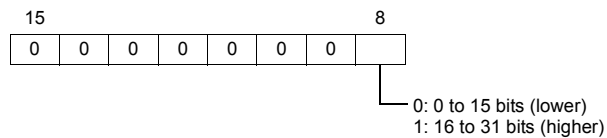

PLC_CTL

Macro command "PLC_CTL F0 F1 F2"

Contents	F0	F1 (= \$u n)		F2
Normal turn, reverse turn or stop command	1 - 8 (PLC1 - 8)	n	Station number	3
		n + 1	Command: 0	
		n + 2	0: Stop command 1: Normal turn command 2: Reverse turn command	
Frequency command setting	1 - 8 (PLC1 - 8)	n	Station number	3
		n + 1	Command: 1	
		n + 2	Frequency (0 to 400 Hz)	

Contents	F0	F1 (= \$u n)	F2																
Intelligent terminal status setting	1 - 8 (PLC1 - 8)	n	Station number	6															
		n + 1	Command: 2																
		n + 2	Data (HH)																
			<table border="1"> <tr> <td>15</td><td>14</td><td>13</td><td>12</td><td>11</td><td>10</td><td>9</td><td>8</td><td>7</td><td>6</td><td>5</td><td>4</td><td>3</td><td>2</td><td>1</td><td>0</td> </tr> </table> Bit 0: "STAT" Pulse train input enabled		15	14	13	12	11	10	9	8	7	6	5	4	3	2	1
		15	14		13	12	11	10	9	8	7	6	5	4	3	2	1	0	
n + 3	Data (HL)																		
	<table border="1"> <tr> <td>15</td><td>14</td><td>13</td><td>12</td><td>11</td><td>10</td><td>9</td><td>8</td><td>7</td><td>6</td><td>5</td><td>4</td><td>3</td><td>2</td><td>1</td><td>0</td> </tr> </table> Bit 0: "SF1" Multistep speed (bit operation) Bit 1: "SF2" Multistep speed (bit operation) Bit 2: "SF3" Multistep speed (bit operation) Bit 3: "SF4" Multistep speed (bit operation) Bit 4: "SF5" Multistep speed (bit operation) Bit 5: "SF6" Multistep speed (bit operation) Bit 6: "SF7" Multistep speed (bit operation) Bit 7: "OLR" Overload limitation selection Bit 8: "TL" Torque limitation valid/invalid Bit 9: "TRQ1" Torque limit selection 1 Bit 10: "TRQ2" Torque limit selection 2 Bit 11: "PPI" P/PI selection Bit 12: "BOK" Brake check Bit 13: "ORT" Orientation Bit 14: "LAC" LAD cancel Bit 15: "PCLR" Positioning deviation clear	15	14	13	12	11	10	9	8	7	6	5	4	3	2	1	0		
15	14	13	12	11	10	9	8	7	6	5	4	3	2	1	0				
n + 4	Data (LH)																		
	<table border="1"> <tr> <td>15</td><td>14</td><td>13</td><td>12</td><td>11</td><td>10</td><td>9</td><td>8</td><td>7</td><td>6</td><td>5</td><td>4</td><td>3</td><td>2</td><td>1</td><td>0</td> </tr> </table> Bit 0: "AT" Analog input selection Bit 1: "SET3" 3rd control Bit 2: "RS" Reset Bit 3: -- Bit 4: "STA" 3-wire start Bit 5: "STP" 3-wire retain Bit 6: "F/R" 3-wire normal/reverse turn Bit 7: "PID" PID selection (valid/invalid) Bit 8: "PIDC" PID integral reset Bit 9: -- Bit 10: "CAS" Control gain selection Bit 11: "UP" Remote control acceleration Bit 12: "DWN" Remote control deceleration Bit 13: "UDC" Remote control data clear Bit 14: -- Bit 15: "OPE" Forced operation	15	14	13	12	11	10	9	8	7	6	5	4	3	2	1	0		
15	14	13	12	11	10	9	8	7	6	5	4	3	2	1	0				
n + 5	Data (LL)																		
		<table border="1"> <tr> <td>15</td><td>14</td><td>13</td><td>12</td><td>11</td><td>10</td><td>9</td><td>8</td><td>7</td><td>6</td><td>5</td><td>4</td><td>3</td><td>2</td><td>1</td><td>0</td> </tr> </table> Bit 0: "FW" Normal turn command Bit 1: "RV" Reverse turn command Bit 2: "CF1" Multistep speed 1 (binary operation) Bit 3: "CF2" Multistep speed 2 (binary operation) Bit 4: "CF3" Multistep speed 3 (binary operation) Bit 5: "CF4" Multistep speed 4 (binary operation) Bit 6: "JG" Jogging (inching operation) Bit 7: "DB" External DC braking Bit 8: "SET" 2nd control Bit 9: "2CH" 2-step acceleration/deceleration Bit 10: -- Bit 11: "FRS" Free-run stop Bit 12: "EXP" External trip Bit 13: "USP" Unattended start protection function Bit 14: "CS" Commercial switching Bit 15: "SFT" Soft lock (control terminal block)	15	14	13	12	11	10	9	8	7	6	5	4	3	2	1	0	
15	14	13	12	11	10	9	8	7	6	5	4	3	2	1	0				

Contents	F0	F1 (= \$u n)		F2
Inverter status readout	1 - 8 (PLC1 - 8)	n	Station number	2
		n + 1	Command: 4	
		n + 2	Status A (BCD) 00: Initial status 01: Waiting for Vdc establishment 02: Stopping 03: Running 04: FRS in progress 05: JG in progress 06: DB in progress 07: F acquisition in progress 08: Retry in progress 09: UV in progress 10: Tripping 11: Waiting for reset	
		n + 3	Status B (BCD) 00: Stopping 01: Running 02: Tripping	
		n + 4	Status C (BCD) 00: -- 01: Stop 02: Deceleration 03: Constant speed 04: Acceleration 05: Normal turn 06: Reverse turn 07: Normal to reverse turn 08: Reverse to normal turn 09: Normal turn start 10: Reverse turn start	
Resetting of setting value to default *	1 - 8 (PLC1 - 8)	n	Station number	2
		n + 1	Command: 8	
Check for EEPROM availability	1 - 8 (PLC1 - 8)	n	Station number	2
		n + 1	Command: 9	
		n + 2	01: Allowed	
Storing of setting values in EEPROM	1 - 8 (PLC1 - 8)	n	Station number	2
		n + 1	Command: 10	
Re-calculation of internal constant	1 - 8 (PLC1 - 8)	n	Station number	2
		n + 1	Command: 11	

 Return data: Data stored from inverter to TS series

* When the initialize parameter of "b084" is set to "00", only trip history is cleared.

18.2.2 SJ700 Series

Communication Setting

Editor

Communication setting

(Underlined setting: default)

Item	Setting	Remarks
Connection Mode	1 : 1 / <u>1:n</u> / Multi-link2 / Multi-link2 (Ethernet)	
Signal Level	RS-232C / <u>RS-422/485</u>	
Baud Rate	<u>4800</u> / 9600 / 19200 bps	
Data Length	<u>7</u> / 8 bits	
Stop Bit	<u>1</u> / 2 bits	
Parity	<u>None</u> / Odd / Even	
Target Port No.	<u>1</u> to 32	

Inverter

Parameter

The communication parameters can be set using keys attached to the inverter.

Be sure to match the settings to those made on the [Communication Setting] tab window of the editor.

(Underlined setting: default)

Function Code	Function Name	Setting	Remarks	
Basic setting	A001	Frequency command selection	03: RS-485	To give the frequency command from TS, always select "03".
	A002	Operation command selection	03: RS-485	To give the operation command from TS, always select "03".
Communication function adjustment	C071	Baud rate selection	<u>04: 4800 bps</u> 05: 9600 bps 06: 19200 bps	
	C072	Communication station number selection	<u>1</u> . to 32.	
	C073	Communication bit length selection	<u>7: 7 bits</u> 8: 8 bits	
	C074	Communication parity selection	<u>00: No parity</u> 01: Even parity 02: Odd parity	
	C075	Communication stop bit selection	<u>1: 1 bit</u> 2: 2 bits	
	C076	Communication error selection	02: Ignored	
	C077	Communication trip time	<u>0.00</u> - 99.99 (s)	
C078	Communication latency	<u>0</u> - 1000. (ms)		
C079	Communication mode selection	00: ASCII		

Terminating resistance

Short-circuit RP-SN (control terminal block) on the terminal inverter.

Available Memory

The available memory setting range varies depending on the device. Be sure to set within the range available with the device to be used. Use [TYPE] when assigning the indirect memory for macro programs.

Memory	TYPE	Remarks
d	00H	Double-word, read only
F	01H	Double-word
A	02H	Double-word
b	03H	Double-word
C	04H	Double-word
H	05H	Double-word
P	06H	Double-word
T (trip history)	07H	Double-word, read only

Indirect Memory Designation

	15	8 7	0
n + 0	Models (11 to 18)	Memory type	
n + 1	Address No.		
n + 2	Expansion code *	Bit designation	
n + 3	00	Station number	

* In the expansion code, set which word, higher or lower, is to be read when a double-word address is specified.

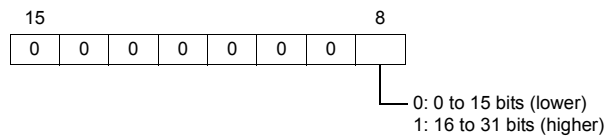

PLC_CTL

Macro command "PLC_CTL F0 F1 F2"

Contents	F0	F1 (= \$u n)		F2
Normal turn, reverse turn or stop command	1 - 8 (PLC1 - 8)	n	Station number	3
		n + 1	Command: 0	
		n + 2	0: Stop command 1: Normal turn command 2: Reverse turn command	
Frequency command setting	1 - 8 (PLC1 - 8)	n	Station number	3
		n + 1	Command: 1	
		n + 2	Frequency (0 to 400 Hz)	

Contents	F0	F1 (= \$u n)														F2			
Intelligent terminal status setting	1 - 8 (PLC1 - 8)	n	Station number														6		
		n + 1	Command: 2																
		n + 2	Data (HH)																
			15	14	13	12	11	10	9	8	7	6	5	4	3	2		1	0
		n + 3	Data (HL)																
15	14		13	12	11	10	9	8	7	6	5	4	3	2	1	0	Bit 0: "SF1" Multistep speed (bit operation) Bit 1: "SF2" Multistep speed (bit operation) Bit 2: "SF3" Multistep speed (bit operation) Bit 3: "SF4" Multistep speed (bit operation) Bit 4: "SF5" Multistep speed (bit operation) Bit 5: "SF6" Multistep speed (bit operation) Bit 6: "SF7" Multistep speed (bit operation) Bit 7: "OLR" Overload limitation selection Bit 8: "TL" Torque limitation valid/invalid Bit 9: "TRQ1" Torque limit selection 1 Bit 10: "TRQ2" Torque limit selection 2 Bit 11: "PPI" P/PI selection Bit 12: "BOK" Brake check Bit 13: "ORT" Orientation Bit 14: "LAC" LAD cancel Bit 15: "PCLR" Positioning deviation clear		
n + 4	Data (LH)																		
15	14	13	12	11	10	9	8	7	6	5	4	3	2	1	0	Bit 0: "AT" Analog input selection Bit 1: -- Bit 2: "RS" Reset Bit 3: -- Bit 4: "STA" 3-wire start Bit 5: "STP" 3-wire retain Bit 6: "F/R" 3-wire normal/reverse turn Bit 7: "PID" PID selection (valid/invalid) Bit 8: "PIDC" PID integral reset Bit 9: -- Bit 10: -- Bit 11: "UP" Remote control acceleration Bit 12: "DWN" Remote control deceleration Bit 13: "UDC" Remote control data clear Bit 14: -- Bit 15: "OPE" Forced operation			
n + 5	Data (LL)																		
15	14	13	12	11	10	9	8	7	6	5	4	3	2	1	0	Bit 0: "FW" Normal turn command Bit 1: "RV" Reverse turn command Bit 2: "CF1" Multistep speed 1 (binary operation) Bit 3: "CF2" Multistep speed 2 (binary operation) Bit 4: "CF3" Multistep speed 3 (binary operation) Bit 5: "CF4" Multistep speed 4 (binary operation) Bit 6: "JG" Jogging (inching operation) Bit 7: "DB" External DC braking Bit 8: "SET" 2nd control Bit 9: "2CH" 2-step acceleration/deceleration Bit 10: -- Bit 11: "FRS" Free-run stop Bit 12: "EXP" External trip Bit 13: "USP" Unattended start protection function Bit 14: "CS" Commercial switching Bit 15: "SFT" Soft lock (control terminal block)			

Contents	F0	F1 (= \$u n)		F2
Inverter status readout	1 - 8 (PLC1 - 8)	n	Station number	2
		n + 1	Command: 4	
		n + 2	Status A (BCD) 00: Initial status 01: Waiting for Vdc establishment 02: Stopping 03: Running 04: FRS in progress 05: JG in progress 06: DB in progress 07: F acquisition in progress 08: Retry in progress 09: UV in progress 10: Tripping 11: Waiting for reset	
		n + 3	Status B (BCD) 00: Stopping 01: Running 02: Tripping	
		n + 4	Status C (BCD) 00: -- 01: Stop 02: Deceleration 03: Constant speed 04: Acceleration 05: Normal turn 06: Reverse turn 07: Normal to reverse turn 08: Reverse to normal turn 09: Normal turn start 10: Reverse turn start	
Resetting of setting value to default *	1 - 8 (PLC1 - 8)	n	Station number	2
		n + 1	Command: 8	
Check for EEPROM availability	1 - 8 (PLC1 - 8)	n	Station number	2
		n + 1	Command: 9	
		n + 2	01: Allowed	
Storing of setting values in EEPROM	1 - 8 (PLC1 - 8)	n	Station number	2
		n + 1	Command: 10	
Re-calculation of internal constant	1 - 8 (PLC1 - 8)	n	Station number	2
		n + 1	Command: 11	

 Return data: Data stored from inverter to TS series

* When the initialize parameter of "b084" is set to "00", only trip history is cleared.

18.2.3 Wiring Diagrams

When Connected at COM1:

RS-485

Wiring diagram 1 - COM1

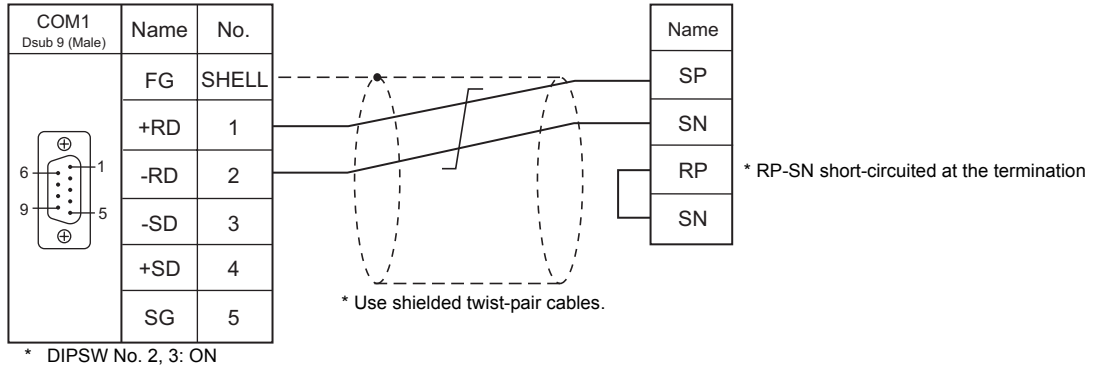

When Connected at COM3:

RS-485

Wiring diagram 1 - COM3

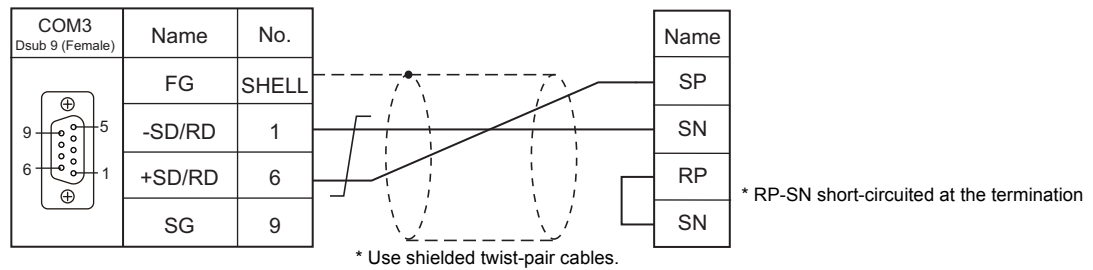

19. IAI

19.1 Temperature Controller/Servo/Inverter Connection

19.1 Temperature Controller/Servo/Inverter Connection

Serial Connection

X-SEL Controller

PLC Selection on the Editor	Model		Port	Signal Level	TS Port	Connection	Lst File
X-SEL Controller	Orthogonal	XSEL-K XSEL-KE XSEL-KT/KET	HOST port	RS-232C	COM2	Wiring diagram 1 - COM2	IAI_XSEL.Lst
	Scalar	XSEL-KX					
	Orthogonal	XSEL-J XSEL-P XSEL-Q	TP port	RS-232C	COM2	Wiring diagram 2 - COM2	
	Scalar	XSEL-JX XSEL-PX XSEL-QX					

Robo Cylinder

PLC Selection on the Editor	Model	Port	Signal Level	TS Port	Connection	Lst File
ROBO CYLINDER (RCP2/ERC)	RCP2 ERC	SIO	RS-485	COM1	Wiring diagram 1 - COM1	IAI_ROBO.Lst
				COM3	Wiring diagram 1 - COM3	
			RS-232C	COM2	Wiring diagram 3 - COM2 ^{*1}	
					Wiring diagram 4 - COM2 ^{*2}	
ROBO CYLINDER (RCS/E-CON)	RCS E-CON	PORT IN	RS-485	COM1	Wiring diagram 1 - COM1	IAI_ROBO.Lst
				COM3	Wiring diagram 1 - COM3	
			RS-232C	COM2	Wiring diagram 3 - COM2 ^{*1}	
					Wiring diagram 4 - COM2 ^{*2}	
PCON/ACON/SCON (MODBUS RTU)	PCON ACON SCON	SIO	RS-485	COM1	Wiring diagram 1 - COM1	IAI_PCON.Lst
				COM3	Wiring diagram 1 - COM3	
			RS-232C	COM2	Wiring diagram 3 - COM2 ^{*1}	
					Wiring diagram 4 - COM2 ^{*2}	

*1 Use the IAI's RS-485 conversion adaptor "RCB-CV-MW" and IAI's external device communication cable "CB-RCA-SIO020 (050)".

*2 Use the IAI's SIO converter "RCB-TU-SIO-A/B".

19.1.1 X-SEL Controller

Communication Setting

Editor

Communication setting

(Underlined setting: default)

Item	Setting	Remarks
Connection Mode	1 : 1 / <u>1:n</u> / Multi-link2	
Signal Level	RS-232C / RS-422/485	
Baud Rate	9600 / 19200 / <u>38400</u> / 57600 / 115K bps	
Data Length	8 bits	
Stop Bit	1 bit	
Parity	None	
Target Port No.	0 to 31	

X-SEL Controller

Application software

Set parameters using the application software.

(Underlined setting: default)

Parameter	Parameter Name	Setting
I/O parameter 90	Channel 1 usage	2 (IAI protocol B)
I/O parameter 91	Channel 1 code	0 to 31
I/O parameter 92	Baud rate	<u>9600</u> / 19200 / 38400 bps
I/O parameter 93	Data length	8
I/O parameter 94	Stop bit	1
I/O parameter 95	Parity	None
Other parameter 46	Bit pattern	1

Mode switch

Select [AUTO].

System I/O connector

If the servo cannot be turned on, check the wiring of the system I/O connector.

- XSEL-K/KE/KT/KET/KX/JJ/JX (with built-in cutout relay)**
 Set the normally-closed type emergency stop input between the EMG terminals or short-circuit these terminals. When they are open, operation is disabled due to an emergency stop.
 For the ENB terminals, set the normally-closed safety gate input or short-circuit them. When they are open, operation is disabled due to the shutout of the power.
- XSEL-P/PX (with built-in cutout relay)**
 Short-circuit terminals of "EMG1 line+" and "EMGin +24V". For "EMG1 line-" and "EMGin IN", connect the normally-closed type emergency stop switch or short-circuit them. When they are open, operation is disabled due to an emergency stop.
 Short-circuit terminals of "ENB1 line+" and "ENBin +24V". For "ENB1 line-" and "ENBin IN", connect the normally-closed type enable switch or short-circuit them. When they are open, operation is disabled due to the shutout of the power.
- XSEL-Q/QX (with external cutout relay)**
 Install wiring by referring to the specifications sheet of X-SEL.

Available Memory

The available memory setting range varies depending on the models. Be sure to set within the range available for the device. Use [TYPE] when assigning the indirect memory for macro programs.

Memory	TYPE	Remarks
20B (input port)	00H	Read only, virtual input port not available
20C (output port)	01H	Virtual output port not available
20D (flag)	02H	
20E (integer variable) *1	03H	Double-word
210 (string) *2	04H	
208 (effective point data count)	05H	Read only
212 (axis status)	06H	Double-word, read only
213 (program status)	07H	Read only
215 (system status)	08H	Read only
253 (program)	09H	Write only
2A1 (scalar axis status)	0AH	Double-word, read only

*1 For 20E (integer variable) XXYYYY

Variable number 0000 to 4095
Program number 00 to 99

*2 For 210 (string) XXYYYY

Column number 0000 to 4095
Program number 00 to 99

Memory: 208 (Effective Point Data Count)

Address	Name
0	Effective point data count

Memory: 212 (Axis Status)

Address	Name
0	Axis 1 axis status
1	Axis 1 axis sensor input status
2	Axis 1 axis-related error code
3	Axis 1 encoder status
4	Axis 1 current position
10	Axis 2 axis status
11	Axis 2 axis sensor input status
12	Axis 2 axis-related error code
13	Axis 2 encoder status
14	Axis 2 current position
20	Axis 3 axis status
21	Axis 3 axis sensor input status
22	Axis 3 axis-related error code
23	Axis 3 encoder status
24	Axis 3 current position
30	Axis 4 axis status
31	Axis 4 axis sensor input status
32	Axis 4 axis-related error code
33	Axis 4 encoder status
34	Axis 4 current position

Memory: 213 (Program Status)

Address	Name
0	Status
1	Running program step number
2	Program-sensitive error code
3	Error occurrence step

Memory: 215 (System Status)

Address	Name
0	System mode
1	Most significant level system error number
2	Most recent system error number
3	System status byte 1
4	System status byte 2
5	System status byte 3
6	System status byte 4

Memory: 253 (Program)

Address	Name	Value
Program number	Program	0: Program end 1: Program execution 2: Program pause 3: Program one step execution 4: Program execution restart

Memory: 2A1 (Scalar Axis Status)

Address	Name
0	Workpiece coordinate system number
1	Tool coordinate system number
2	Axis common status
3	Axis 1 axis status
4	Axis 1 axis sensor input status
5	Axis 1 axis-related error code
6	Axis 1 encoder status
7	Axis 1 current position
10	Workpiece coordinate system number
11	Tool coordinate system number
12	Axis common status
13	Axis 2 axis status
14	Axis 2 axis sensor input status
15	Axis 2 axis-related error code
16	Axis 2 encoder status
17	Axis 2 current position
20	Workpiece coordinate system number
21	Tool coordinate system number
22	Axis common status
23	Axis 3 axis status
24	Axis 3 axis sensor input status
25	Axis 3 axis-related error code
26	Axis 3 encoder status
27	Axis 3 current position
30	Workpiece coordinate system number
31	Tool coordinate system number
32	Axis common status
33	Axis 4 axis status
34	Axis 4 axis sensor input status
35	Axis 4 axis-related error code
36	Axis 4 encoder status
37	Axis 4 current position

PLC_CTL

Real numbers used on the TS series are IEEE 32-bit single precision ones.

Contents	F0	F1 (= \$u n)	F2										
Version inquiry	1 - 8 (PLC1 - 8)	n	Station number	4									
		n + 1	Command: 201 (HEX)										
		n + 2	Unit type 0: Main CPU application area 1: Main CPU core area 2: Driver CPU										
		n + 3	Device number										
		n + 4	Model code										
		n + 5	Unit code										
		n + 6	Version number										
		n + 7	Year (4-digit)										
		n + 8	Month										
		n + 9	Day										
		n + 10	Hour										
		n + 11	Minute										
		n + 12	Second										
Effective point data count inquiry	1 - 8 (PLC1 - 8)	n	Station number	2									
		n + 1	Command: 208 (HEX)										
		n + 2	Effective point data count										
Effective point data inquiry	1 - 8 (PLC1 - 8)	n	Station number	3									
		n + 1	Command: 209 (HEX)										
		n + 2	Inquiry point number										
		n + 3	Effective point data count										
		n + 4	Point number										
		n + 5	Axis pattern: m (number of ON bits) Bit <table border="1" style="display: inline-table; vertical-align: middle;"><tr><td>-</td><td>7</td><td>6</td><td>5</td><td>4</td><td>3</td><td>2</td><td>1</td><td>0</td></tr></table> └─ Axis 1 : └─ Axis 6		-	7	6	5	4	3	2	1	0
		-	7		6	5	4	3	2	1	0		
		n + 6	Acceleration										
		n + 7	Deceleration										
		n + 8	Speed										
		n + 9 to n + 10	Axis pattern 1		Position data								
n + 11 -	Axis pattern m	Position data											
Real variable inquiry Disabled for X-SEL version 0.41 or earlier	1 - 8 (PLC1 - 8)	n	Station number	5									
		n + 1	Command: 20F (HEX)										
		n + 2	Program number										
		n + 3	Inquiry start variable number										
		n + 4	Inquiry data count: m (1 to 10)										
		n + 5	Response start variable number										
		n + 6	Response variable data count: m										
		n + 7 to n + 8	Data count 1		Data for variable								
		n + 9 -	Data count m		Data for variable								
Axis status inquiry For orthogonal	1 - 8 (PLC1 - 8)	n	Station number	3									
		n + 1	Command: 212 (HEX)										
		n + 2	Inquiry axis pattern: m (number of ON bits) Bit <table border="1" style="display: inline-table; vertical-align: middle;"><tr><td>-</td><td>7</td><td>6</td><td>5</td><td>4</td><td>3</td><td>2</td><td>1</td><td>0</td></tr></table> └─ Axis 1 : └─ Axis 6		-	7	6	5	4	3	2	1	0
		-	7		6	5	4	3	2	1	0		
		n + 3	Status m = 1		Axis status								
		n + 4			Axis sensor input status								
		n + 5			Axis-related error code								
		n + 6			Encoder status								
		n + 7 to n + 8			Current position								
		n + 9 -	Status (m = 2)		:								

Contents	F0	F1 (= \$u n)		F2									
Program status inquiry	1 - 8 (PLC1 - 8)	n	Station number	3									
		n + 1	Command: 213 (HEX)										
		n + 2	Program number										
		n + 3	Status										
		n + 4	Running program step number										
		n + 5	Program-sensitive error code										
		n + 6	Error occurrence step number										
System status inquiry	1 - 8 (PLC1 - 8)	n	Station number	2									
		n + 1	Command: 215 (HEX)										
		n + 2	System mode										
		n + 3	Most significant level system error number										
		n + 4	Most recent system error number										
		n + 5	System status byte 1										
		n + 6	System status byte 2										
		n + 7	System status byte 3										
Error detailed information inquiry	1 - 8 (PLC1 - 8)	n	Station number	5									
		n + 1	Command: 216 (HEX)										
		n + 2	Type 1 0: System error 1: Axis error 2: Program error 3: Error in error list record										
		n + 3	Type 2 In the event of a system error: 0: Most significant level error 1: Most recent error In the event of an axis error: Axis number In the event of a program error: Program number In the event of an error in error list record: Record number										
		n + 4	Error number										
		n + 5 to n + 6	Detailed information 1										
		n + 7 to n + 8	Detailed information 2										
		n + 9 to n + 10	Detailed information 3										
		n + 11 to n + 12	Detailed information 4										
		n + 13 to n + 14	Detailed information 5										
		n + 15 to n + 16	Detailed information 6										
		n + 17 to n + 18	Detailed information 7										
		n + 19 to n + 20	Detailed information 8										
		n + 21 to n + 27	System reserved										
		n + 28	Number of message bytes										
n + 29 -	Message character string (equivalent to message bytes)												
Servo ON/OFF	1 - 8 (PLC1 - 8)	n	Station number	4									
		n + 1	Command: 232 (HEX)										
		n + 2	Axis pattern Bit <table border="1" style="display: inline-table; vertical-align: middle;"><tr><td>-</td><td>7</td><td>6</td><td>5</td><td>4</td><td>3</td><td>2</td><td>1</td><td>0</td></tr></table> <div style="display: inline-block; vertical-align: middle; margin-left: 100px;">└─ Axis 1 ⋮ └─ Axis 6</div>		-	7	6	5	4	3	2	1	0
-	7	6	5	4	3	2	1	0					
n + 3	Servo 0: OFF 1: ON												
Origin return For orthogonal	1 - 8 (PLC1 - 8)	n	Station number	5									
		n + 1	Command: 233 (HEX)										
		n + 2	Axis pattern Bit <table border="1" style="display: inline-table; vertical-align: middle;"><tr><td>-</td><td>7</td><td>6</td><td>5</td><td>4</td><td>3</td><td>2</td><td>1</td><td>0</td></tr></table> <div style="display: inline-block; vertical-align: middle; margin-left: 100px;">└─ Axis 1 ⋮ └─ Axis 6</div>		-	7	6	5	4	3	2	1	0
		-	7		6	5	4	3	2	1	0		
n + 3	End search speed for origin return (mm/sec)												
n + 4	Creep speed for origin return (mm/sec)												

Contents	F0	F1 (= \$u n)	F2										
Traverse by absolute command For orthogonal	1 - 8 (PLC1 - 8)	n	Station number	6 + 2m									
		n + 1	Command: 234 (HEX)										
		n + 2	Axis pattern: m (number of ON bits) Bit <table border="1" style="display: inline-table; vertical-align: middle;"><tr><td>-</td><td>7</td><td>6</td><td>5</td><td>4</td><td>3</td><td>2</td><td>1</td><td>0</td></tr></table> <div style="display: inline-block; vertical-align: middle; margin-left: 100px;"> ↙ Axis 1 : ↘ Axis 6 </div>		-	7	6	5	4	3	2	1	0
		-	7		6	5	4	3	2	1	0		
		n + 3	Acceleration										
		n + 4	Deceleration										
		n + 5	Speed										
		n + 6 to n + 7	Axis pattern (m = 1) Absolute coordinate data										
		n + 8 -	Axis pattern (m = 2) Absolute coordinate data										
	:												
Traverse by relative command For orthogonal	1 - 8 (PLC1 - 8)	n	Station number	6 + 2m									
		n + 1	Command: 235 (HEX)										
		n + 2	Axis pattern: m (number of ON bits) Bit <table border="1" style="display: inline-table; vertical-align: middle;"><tr><td>-</td><td>7</td><td>6</td><td>5</td><td>4</td><td>3</td><td>2</td><td>1</td><td>0</td></tr></table> <div style="display: inline-block; vertical-align: middle; margin-left: 100px;"> ↙ Axis 1 : ↘ Axis 6 </div>		-	7	6	5	4	3	2	1	0
		-	7		6	5	4	3	2	1	0		
		n + 3	Acceleration										
		n + 4	Deceleration										
		n + 5	Speed										
		n + 6 to n + 7	Axis pattern (m = 1) Relative coordinate data										
		n + 8 -	Axis pattern (m = 2) Relative coordinate data										
	:												
Jog/inching traverse	1 - 8 (PLC1 - 8)	n	Station number	9									
		n + 1	Command: 236 (HEX)										
		n + 2	Axis pattern m Bit <table border="1" style="display: inline-table; vertical-align: middle;"><tr><td>-</td><td>7</td><td>6</td><td>5</td><td>4</td><td>3</td><td>2</td><td>1</td><td>0</td></tr></table> <div style="display: inline-block; vertical-align: middle; margin-left: 100px;"> ↙ Axis 1 : ↘ Axis 6 </div>		-	7	6	5	4	3	2	1	0
		-	7		6	5	4	3	2	1	0		
		n + 3	Acceleration										
		n + 4	Deceleration										
		n + 5	Speed										
		n + 6 to n + 7	Inching distance (absolute command) 0: Distance not designated = jog										
n + 8	Direction 0: Negative direction 1: Positive direction												
Traverse by point number command For orthogonal	1 - 8 (PLC1 - 8)	n	Station number	7									
		n + 1	Command: 237 (HEX)										
		n + 2	Axis pattern Bit <table border="1" style="display: inline-table; vertical-align: middle;"><tr><td>-</td><td>7</td><td>6</td><td>5</td><td>4</td><td>3</td><td>2</td><td>1</td><td>0</td></tr></table> <div style="display: inline-block; vertical-align: middle; margin-left: 100px;"> ↙ Axis 1 : ↘ Axis 6 </div>		-	7	6	5	4	3	2	1	0
		-	7		6	5	4	3	2	1	0		
		n + 3	Acceleration										
		n + 4	Deceleration										
		n + 5	Speed										
n + 6	Point number												
Operation stop and cancel	1 - 8 (PLC1 - 8)	n	Station number	4									
		n + 1	Command: 238 (HEX)										
		n + 2	Stop axis pattern Bit <table border="1" style="display: inline-table; vertical-align: middle;"><tr><td>-</td><td>7</td><td>6</td><td>5</td><td>4</td><td>3</td><td>2</td><td>1</td><td>0</td></tr></table> <div style="display: inline-block; vertical-align: middle; margin-left: 100px;"> ↙ Axis 1 : ↘ Axis 6 </div>		-	7	6	5	4	3	2	1	0
		-	7		6	5	4	3	2	1	0		
n + 3	Additional command												

Contents	F0	F1 (= \$u n)		F2		
Successive writing within designated point data range	1 - 8 (PLC1 - 8)	n	Station number	$4 + (4 + 2m)t = \alpha$		
		n + 1	Command: 244 (HEX)			
		n + 2	Change start point data number			
		n + 3	Change point data count: t (1 to 2)			
		n + 4	Point data		Axis pattern: m (number of ON bits)	
					Bit	
		n + 5	t = 1		Acceleration	
		n + 6	Deceleration			
		n + 7	Speed			
		n + 8 to n + 9	Point data		Axis pattern (m = 1)	Position data
					Axis pattern (m = 2)	Position data
		n + 10 - α	Point data		:	:
					Point data (t = 2)	:
α + 1	Change start point data number					
α + 2	Change complete point data count					
Change point data successive writing	1 - 8 (PLC1 - 8)	n	Station number	$4 + (4 + 2m)t = \alpha$		
		n + 1	Command: 245 (HEX)			
		n + 2	Change point data count: t (1 to 2)			
		n + 3	Change point data number			
		n + 4	Point data		Axis pattern: m (number of ON bits)	
					Bit	
		n + 5	t = 1		Acceleration	
		n + 6	Deceleration			
		n + 7	Speed			
		n + 8 to n + 9	Point data		Axis pattern (m = 1)	Position data
					Axis pattern (m = 2)	Position data
		n + 10 to α	Point data		:	:
					Point data (t = 2)	:
α + 1	Change complete point data count					
Point data clear	1 - 8 (PLC1 - 8)	n	Station number	4		
		n + 1	Command: 246 (HEX)			
		n + 2	Clear start point data number			
		n + 3	Clear point data count			
Real variable change	1 - 8 (PLC1 - 8)	n	Station number	5 + 2m		
		n + 1	Command: 24D (HEX)			
		n + 2	Program number			
		n + 3	Change start variable number			
		n + 4	Change variable data count: m (1 to 10)			
		n + 5 to n + 6	Variable data (m = 1)		Real variable data	
					Real variable data	
		n + 7 -	Variable data (m = 2)		Real variable data	
:						
n + {5 + (2*m)}	Change complete data count					
Alarm reset	1 - 8 (PLC1 - 8)	n	Station number	2		
		n + 1	Command: 252 (HEX)			
Program execution	1 - 8 (PLC1 - 8)	n	Station number	3		
		n + 1	Command: 253 (HEX)			
		n + 2	Program number			
Program end	1 - 8 (PLC1 - 8)	n	Station number	3		
		n + 1	Command: 254 (HEX)			
		n + 2	Program number			

Contents	F0	F1 (= \$u n)		F2									
Program pause	1 - 8 (PLC1 - 8)	n	Station number	3									
		n + 1	Command: 255 (HEX)										
		n + 2	Program number										
Program one step execution	1 - 8 (PLC1 - 8)	n	Station number	3									
		n + 1	Command: 256 (HEX)										
		n + 2	Program number										
Program execution restart	1 - 8 (PLC1 - 8)	n	Station number	3									
		n + 1	Command: 257 (HEX)										
		n + 2	Program number										
Software reset	1 - 8 (PLC1 - 8)	n	Station number	2									
		n + 1	Command: 25B (HEX)										
Request for drive source recovery	1 - 8 (PLC1 - 8)	n	Station number	2									
		n + 1	Command: 25C (HEX)										
Request for operation pause cancel	1 - 8 (PLC1 - 8)	n	Station number	2									
		n + 1	Command: 25E (HEX)										
Speed change For orthogonal	1 - 8 (PLC1 - 8)	n	Station number	4									
		n + 1	Command: 262 (HEX)										
		n + 2	Axis pattern Bit <table border="1" style="display: inline-table; vertical-align: middle;"><tr><td>-</td><td>7</td><td>6</td><td>5</td><td>4</td><td>3</td><td>2</td><td>1</td><td>0</td></tr></table> └─ Axis 1 └─ Axis 6		-	7	6	5	4	3	2	1	0
-	7	6	5	4	3	2	1	0					
n + 3	Speed												
Successive inquiry within designated range for coordinate system definition data For scalar	1 - 8 (PLC1 - 8)	n	Station number	5									
		n + 1	Command: 2A0 (HEX)										
		n + 2	Type 0: Workpiece coordinate system definition data 1: Tool coordinate system definition data										
		n + 3	Inquiry target top number for coordinate system definition data										
		n + 4	Inquiry record count t (1 to 32)										
		n + 5 to n + 6	Coordinate system definition data t = 1		Coordinate offset X axis								
		n + 7 to n + 8			Coordinate offset Y axis								
		n + 9 to n + 10			Coordinate offset Z axis								
		n + 11 to n + 12			Coordinate offset R axis								
		n + 13 -	Coordinate system definition data t = 2										
:	:												
Scalar axis status inquiry For scalar	1 - 8 (PLC1 - 8)	n	Station number	4									
		n + 1	Command: 2A1 (HEX)										
		n + 2	Inquiry axis pattern: m (number of ON bits) Bit <table border="1" style="display: inline-table; vertical-align: middle;"><tr><td>-</td><td>7</td><td>6</td><td>5</td><td>4</td><td>3</td><td>2</td><td>1</td><td>0</td></tr></table> └─ Axis 1 └─ Axis 6		-	7	6	5	4	3	2	1	0
		-	7		6	5	4	3	2	1	0		
		n + 3	Type 0: Base coordinate system 1: Selected workpiece coordinate system 2: System reserved 3: Coordinate system for each axis										
		n + 4	Workpiece coordinate system number										
		n + 5	Tool coordinate system number										
		n + 6	Axis common status										
		n + 7	Axis pattern m = 1		Axis status								
		n + 8			Axis sensor input status								
		n + 9			Axis-related error code								
		n + 10			Encoder status								
		n + 11 to n + 12			Current position								
n + 13 -	Axis pattern (m = 2)												
:	:												

Contents	F0	F1 (= \$u n)	F2											
Successive inquiry within designated range for interference check zone definition data For scalar	1 - 8 (PLC1 - 8)	n	Station number	4										
		n + 1	Command: 2A2 (HEX)											
		n + 2	Inquiry top number for interference check zone definition data											
		n + 3	Inquiry record count t (1 to 16)											
		n + 4	Interference check zone definition data t = 1		Effective axis pattern: m (number of ON bits) Bit <table border="1" style="display: inline-table; vertical-align: middle;"><tr><td>-</td><td>7</td><td>6</td><td>5</td><td>4</td><td>3</td><td>2</td><td>1</td><td>0</td></tr></table> <div style="display: inline-block; vertical-align: middle; margin-left: 100px;">└─ Axis 1 ⋮ └─ Axis 6</div>	-	7	6	5	4	3	2	1	0
		-			7	6	5	4	3	2	1	0		
		n + 5 to n + 6			Axis pattern (m = 1)	Interference check zone definition coordinate 1								
		n + 7 -			Axis pattern (m = 2)	Interference check zone definition coordinate 1								
		:			:	:								
		n + (5 + 2m)			Axis pattern (m = 1)	Interference check zone definition coordinate 2								
		:			Axis pattern (m = 2)	Interference check zone definition coordinate 2								
		:			:	:								
		n + (5 + 4m)			Physical output port number at break-in or global flag number									
		n + (6 + 4m)			Error type definition at break-in									
		n + (7 + 4m)			System reserved									
:	Interference check data t = 2													
:	:													
Traverse by absolute command For scalar	1 - 8 (PLC1 - 8)	n		Station number	7 + 2m									
		n + 1	Command: 2D4 (HEX)											
		n + 2	Axis pattern: m (number of ON bits) Bit <table border="1" style="display: inline-table; vertical-align: middle;"><tr><td>-</td><td>7</td><td>6</td><td>5</td><td>4</td><td>3</td><td>2</td><td>1</td><td>0</td></tr></table> <div style="display: inline-block; vertical-align: middle; margin-left: 100px;">└─ Axis 1 ⋮ └─ Axis 6</div>	-		7	6	5	4	3	2	1	0	
		-	7	6		5	4	3	2	1	0			
		n + 3	Acceleration											
		n + 4	Deceleration											
		n + 5	Speed											
		n + 6	Positioning type											
		n + 7 to n + 8	Axis pattern (m = 1)	Absolute coordinate data										
		n + 9 to n + 10	Axis pattern (m = 2)	Absolute coordinate data										
:	:													
Traverse by relative command For scalar	1 - 8 (PLC1 - 8)	n	Station number	7 + 2m										
		n + 1	Command: 2D5 (HEX)											
		n + 2	Inquiry axis pattern: m (number of ON bits) Bit <table border="1" style="display: inline-table; vertical-align: middle;"><tr><td>-</td><td>7</td><td>6</td><td>5</td><td>4</td><td>3</td><td>2</td><td>1</td><td>0</td></tr></table> <div style="display: inline-block; vertical-align: middle; margin-left: 100px;">└─ Axis 1 ⋮ └─ Axis 6</div>		-	7	6	5	4	3	2	1	0	
		-	7		6	5	4	3	2	1	0			
		n + 3	Acceleration											
		n + 4	Deceleration											
		n + 5	Speed											
		n + 6	Positioning type											
		n + 7 to n + 8	Axis pattern (m = 1)		Relative coordinate data									
		n + 9 to n + 10	Axis pattern (m = 2)		Relative coordinate data									
:	:													

Contents	F0	F1 (= \$u n)	F2										
Traverse by point number command For scalar	1 - 8 (PLC1 - 8)	n	Station number	8									
		n + 1	Command: 2D6 (HEX)										
		n + 2	Inquiry axis pattern: m (number of ON bits) Bit <table border="1" style="display: inline-table; vertical-align: middle;"> <tr> <td>-</td> <td>7</td> <td>6</td> <td>5</td> <td>4</td> <td>3</td> <td>2</td> <td>1</td> <td>0</td> </tr> </table> Axis 1 : Axis 6		-	7	6	5	4	3	2	1	0
		-	7		6	5	4	3	2	1	0		
		n + 3	Acceleration										
		n + 4	Deceleration										
		n + 5	Speed										
		n + 6	Positioning type										
		n + 7 to n + 8	Point number										

Return data: Data stored from controller to TS series

19.1.2 ROBO CYLINDER (RCP2/ERC)

Communication Setting

Editor

Communication setting

(Underlined setting: default)

Item	Setting	Remarks
Connection Mode	1 : 1 / <u>1:n</u> / Multi-link2 / Multi-link2 (Ethernet) / 1 : n multi-link2 (Ethernet)	
Signal Level	<u>RS-232C</u> / RS-422/485	
Baud Rate	9600 / 19200 / <u>38400</u> / 115K bps	
Data Length	8 bits	
Stop Bit	1 bit	
Parity	None	
Target Port No.	0 to 15	

ROBO CYLINDER

RCP2

Application software

Set parameters using the application software.

(Underlined setting: default)

Parameter No.	Parameter Name	Setting
Parameter 16	SIO baud rate	9600 / 19200 / <u>38400</u> / 115200 bps

Axis number setting switch (ADRS)

ADRS	Setting	Remarks
	0 to F (0 to 15)	

After changing the setting, be sure to turn the power off and back on again.

PORT switch (PORT)

PORT	Setting	Remarks
PORT  ON OFF	ON	

Emergency stop terminal block

When the servo cannot be turned on, check the wiring of the emergency stop terminal block.

- RCP2-C / RCP2-CF (with built-in cutout relay)**
 Connect the EMG switch between the S1 terminal and the 24-V terminal.
 When the EMG switch is not used, short-circuit them.
 Short-circuit the terminals S2 and EMG, and MPI and MPO, respectively.
- RCP2-CG (with external cutout relay)**
 Install wiring by referring to the specifications sheet of RCP2.

ERC

Application software

Set parameters using the application software.

(Underlined setting: default)

Parameter No.	Parameter Name	Setting
Parameter 16	Serial communication speed	9600 / 19200 / <u>38400</u> / 115200 bps

Item	Parameter Name	Setting
Axis number assignment	Axis number table	0 to 15

RCB-TU-SIO-A/B

PORT switch (PORT)

PORT	Setting	Remarks
 SW1	ON	

Emergency stop terminal block

When the servo cannot be turned on, connect the EMG switch between the EMG1 terminal and the EMG2 terminal on the emergency stop terminal block.

When the EMG switch is not used, short-circuit them.

Available Memory

The available memory setting range varies depending on the models. Be sure to set within the range available for the device. Use [TYPE] when assigning the indirect memory for macro programs.

Memory	TYPE	Remarks
SW (status)	00H	Read only
PD (positioning data)	01H	Double-word, write only
CW (control data)	02H	Write only
4D (window area)	03H	Double-word
MD (window area (in mm))	04H	Double-word

PLC_CTL

Contents	F0	F1 (= \$u n)		F2
		n	Station number	
Non-volatile memory area ↓ Transfer to window area	1 - 8 (PLC1 - 8)	n + 1	Command: 51 (HEX)	3
		n + 2	Position number RCP2: 0 to 63 ERC: 0 to 7	
		n	Station number	
Window area ↓ Transfer to non-volatile memory area	1 - 8 (PLC1 - 8)	n + 1	Command: 56 (HEX)	3
		n + 2	Position number RCP2: 0 to 63 ERC: 0 to 7	
		n + 3 to n + 4	Total number of writing times	
		n	Station number	
Remaining amount of movement cancel	1 - 8 (PLC1 - 8)	n + 1	Command: 64 (HEX)	2
		n	Station number	
Speed, acceleration setting (in mm)	1 - 8 (PLC1 - 8)	n + 1	Command: 66 (HEX)	4
		n + 2	Speed	
		n + 3	Acceleration	

Contents	F0	F1 (= \$u n)		F2
Speed, acceleration setting	1 - 8 (PLC1 - 8)	n	Station number	4
		n + 1	Command: 76 (HEX)	
		n + 2	Speed	
		n + 3	Acceleration	
Deceleration stop	1 - 8 (PLC1 - 8)	n	Station number	2
		n + 1	Command: 6B (HEX)	
Alarm reset	1 - 8 (PLC1 - 8)	n	Station number	2
		n + 1	Command: 72 (HEX)	

Return data: Data stored from controller to TS series

19.1.3 ROBO CYLINDER (RCS/E-CON)

Communication Setting

Editor

Communication setting

(Underlined setting: default)

Item	Setting	Remarks
Connection Mode	1 : 1 / <u>1:n</u> / Multi-link2 / Multi-link2 (Ethernet) / 1 : n Multi-link2 (Ethernet)	
Signal Level	<u>RS-232C</u> / RS-422/485	
Baud Rate	9600 / 19200 / <u>38400</u> / 57600 / 115K bps	
Data Length	8 bits	
Stop Bit	1 bit	
Parity	None	
Target Port No.	0 to 15	

ROBO CYLINDER

RCS

Application software

Set parameters using the application software.

(Underlined setting: default)

Parameter No.	Parameter Name	Setting
Parameter 16	SIO baud rate	9600 / 19200 / <u>38400</u> / 58600 / 115200 bps

RCS axis number setting switch

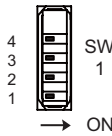
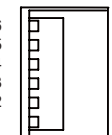
SW	Axis number	Setting				Remarks
		1	2	3	4	
RCS-C: SW1 	<u>0</u>	OFF	OFF	OFF	OFF	Always turn the switches 5 and 6 of RCS-E.
	1	ON	OFF	OFF	OFF	
	2	OFF	ON	OFF	OFF	
	3	ON	ON	OFF	OFF	
4	OFF	OFF	ON	OFF		
RCS-E: SW (switch No. 1 to 4) 	5	ON	OFF	ON	OFF	
	6	OFF	ON	ON	OFF	
	7	ON	ON	ON	OFF	
	8	OFF	OFF	OFF	ON	
	9	ON	OFF	OFF	ON	
	10	OFF	ON	OFF	ON	
	11	ON	ON	OFF	ON	
	12	OFF	OFF	ON	ON	
	13	ON	OFF	ON	ON	
	14	OFF	ON	ON	ON	
	15	ON	ON	ON	ON	

When changing the switch setting, turn the power off.

PORT switch (PORT)

PORT	Setting	Remarks
	ON	

Emergency stop terminal block

When the servo cannot be turned on, connect the EMG switch between the EMG1 terminal and the EMG2 terminal on the emergency stop terminal block.
 When the EMG switch is not used, short-circuit them.

E-CON

Application software

Set parameters using the application software.

(Underlined setting: default)

Parameter No.	Parameter Name	Setting
Parameter 16	Serial communication speed	9600 / 19200 / <u>38400</u> / 115200 bps

RCS axis number setting switch

SW1	Axis number	Setting				Remarks
		Switch number				
		1	2	3	4	
	<u>0</u>	OFF	OFF	OFF	OFF	
	1	ON	OFF	OFF	OFF	
	2	OFF	ON	OFF	OFF	
	3	ON	ON	OFF	OFF	
	4	OFF	OFF	ON	OFF	
	5	ON	OFF	ON	OFF	
	6	OFF	ON	ON	OFF	
	7	ON	ON	ON	OFF	
	8	OFF	OFF	OFF	ON	
	9	ON	OFF	OFF	ON	
	10	OFF	ON	OFF	ON	
	11	ON	ON	OFF	ON	
	12	OFF	OFF	ON	ON	
	13	ON	OFF	ON	ON	
	14	OFF	ON	ON	ON	
15	ON	ON	ON	ON		

When changing the switch setting, turn the power off.

PORT switch (PORT)

PORT	Setting	Remarks
	ON	

Emergency stop terminal block

When the servo cannot be turned on, connect the EMG switch between the EMG1 terminal and the EMG2 terminal on the emergency stop terminal block.
 When the EMG switch is not used, short-circuit them.

RCB-TU-SIO-A/B

PORT switch (PORT)

PORT	Setting	Remarks
	ON	

Emergency stop terminal block

When the servo cannot be turned on, connect the EMG switch between the EMG1 terminal and the EMG2 terminal on the emergency stop terminal block.

When the EMG switch is not used, short-circuit them.

Available Memory

The available memory setting range varies depending on the models. Be sure to set within the range available for the device. Use [TYPE] when assigning the indirect memory for macro programs.

Memory	TYPE	Remarks
SW (status)	00H	Read only
PD (positioning data)	01H	Double-word, write only
CW (control data)	02H	Write only
4D (window area)	03H	Double-word
MD (window area (in mm))	04H	Double-word

PLC_CTL

Contents	F0	F1 (= \$u n)		F2
Non-volatile memory area ↓ Transfer to window area	1 - 8 (PLC1 - 8)	n	Station number	3
		n + 1	Command: 51 (HEX)	
		n + 2	Position number RCP2: 0 to 15 E-CON: 0 to 63	
Window area ↓ Transfer to non-volatile memory area	1 - 8 (PLC1 - 8)	n	Station number	3
		n + 1	Command: 56 (HEX)	
		n + 2	Position number	
		n + 3 to n + 4	Total number of writing times	
Remaining amount of movement cancel	1 - 8 (PLC1 - 8)	n	Station number	2
		n + 1	Command: 64 (HEX)	
Speed, acceleration setting (in mm)	1 - 8 (PLC1 - 8)	n	Station number	4
		n + 1	Command: 66 (HEX)	
		n + 2	Speed	
		n + 3	Acceleration	
Speed, acceleration setting	1 - 8 (PLC1 - 8)	n	Station number	4
		n + 1	Command: 76 (HEX)	
		n + 2	Speed	
Deceleration stop	1 - 8 (PLC1 - 8)	n	Station number	2
		n + 1	Command: 6B (HEX)	
Alarm reset	1 - 8 (PLC1 - 8)	n	Station number	2
		n + 1	Command: 72 (HEX)	

 Return data: Data stored from controller to TS series

19.1.4 PCON / ACON / SCON (MODBUS RTU)

Communication Setting

Editor

Communication setting

(Underlined setting: default)

Item	Setting	Remarks
Connection Mode	1 : 1 / <u>1:n</u> / Multi-link2	
Signal Level	RS-232C / RS-422/485	
Baud Rate	9600 / 19200 / <u>38400</u> / 57600 / 115K bps	
Data Length	8 bits	
Stop Bit	1 bit	
Parity	None	
Target Port No.	0 to 15	Set the same number as the IAI axis number.

PCON / ACON / SCON

Exclusive software

Set parameters using the exclusive software.

(Underlined setting: default)

Parameter No.	Parameter Name	Setting
Parameter 16	SIO baud rate	9600 / 19200 / <u>38400</u> / 115200 bps

Axis number setting switch (ADRS)

ADRS	Setting	Remarks
	0 to F (0 to 15)	

After changing the setting, be sure to turn the power off and back on again.

Mode select switch

Select [MANU].

Emergency stop terminal block

When the servo cannot be turned on, check the emergency stop terminal block.

- ACON-C, PCON-C/CF (with built-in cutout relay)**
 Connect the EMG switch between the S1 terminal and the 24-V terminal.
 When the EMG switch is not used, short-circuit them.
 Short-circuit the terminals S2 and EMG-, and MPI and MPO, respectively.
- ACON-CY/PL/PO/SE, PCON-CY/PL/PO/SE (with built-in cutout relay)**
 Connect the EMG switch between the EMG- terminal and the 24-V terminal.
 When the EMG switch is not used, short-circuit them.
 Short-circuit the MPI terminal and the MPO terminal.
- ACON-CG / PCON-CG (with external cutout relay)**
 Install wiring by referring to the specifications sheet of ACON/PCON.
- SCON**
 Connect the EMG switch between the S1 terminal and the EMG- terminal.
 When the EMG switch is not used, short-circuit them.
 Short-circuit the S2 terminal and the EMG+ terminal.

RCB-TU-SIO-A/B**PORT switch (PORT)**

PORT	Setting	Remarks
 SW1	ON	

Emergency stop terminal block

When the servo cannot be turned on, connect the EMG switch between the EMG1 terminal and the EMG2 terminal on the emergency stop terminal block.

When the EMG switch is not used, short-circuit them.

Available Memory

The available memory setting range varies depending on the models. Be sure to set within the range available for the device. Use [TYPE] when assigning the indirect memory for macro programs.

Memory	TYPE	Remarks
Coil (coil)	00H	
Register (holding register)	02H	

19.1.5 Wiring Diagrams

When Connected at COM1:

RS-485

Wiring diagram 1 - COM1

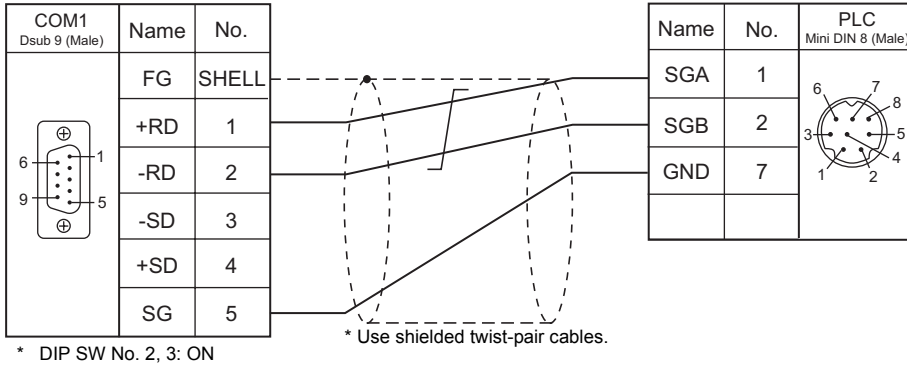

When Connected at COM2:

RS-232C

Wiring diagram 1 - COM2

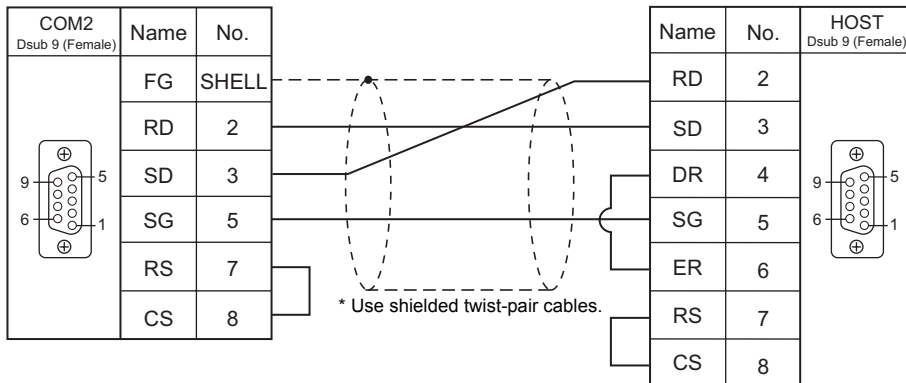

Wiring diagram 2 - COM2

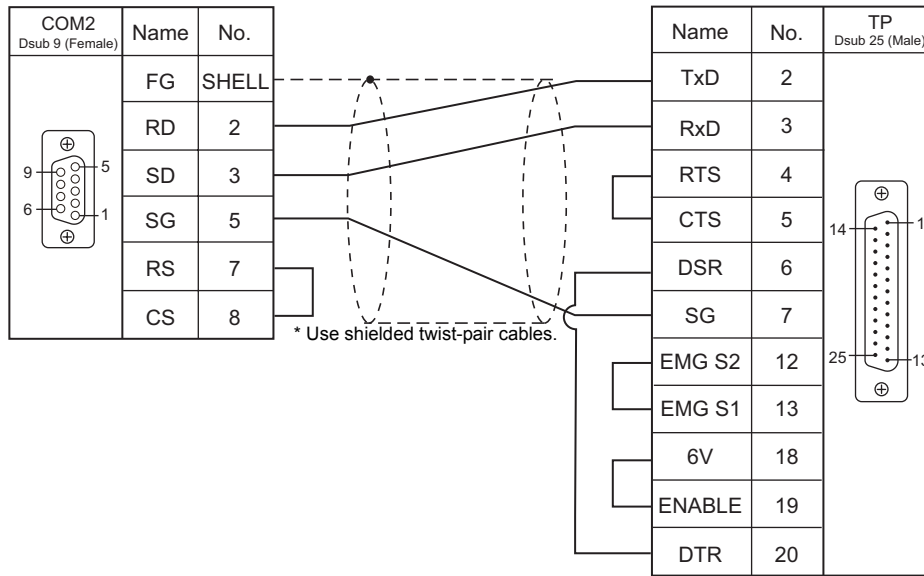

Wiring diagram 3 - COM2

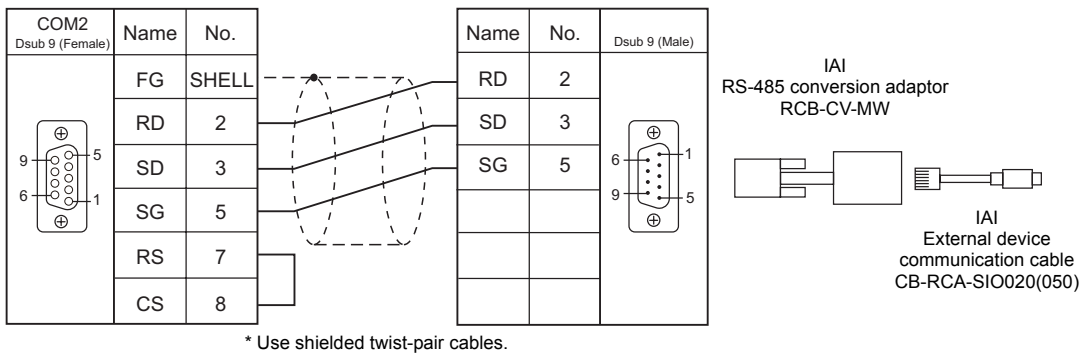

Wiring diagram 4 - COM2

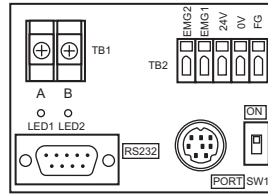
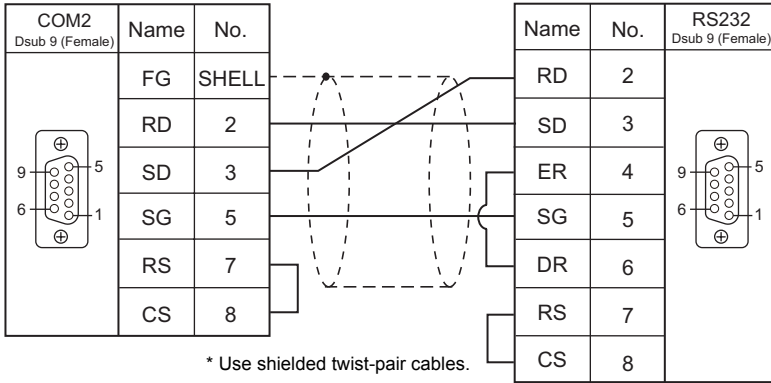

IAI SIO converter
RCB-TU-SIO-A/B

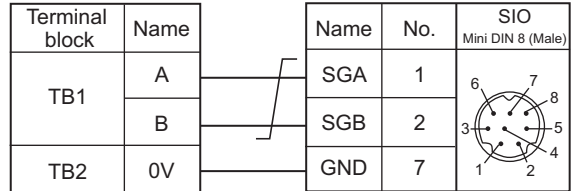

When Connected at COM3:

RS-485

Wiring diagram 1 - COM3

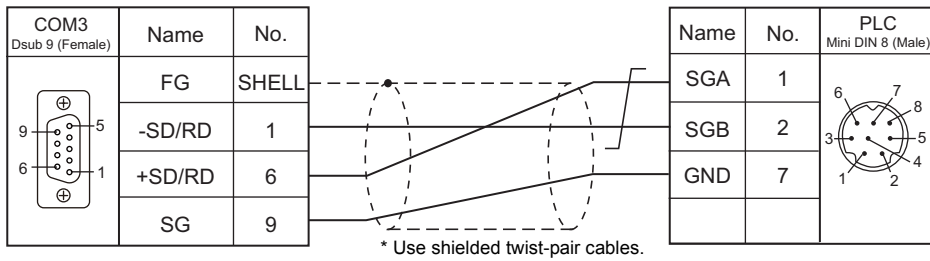

20. IDEC

20.1 PLC Connection

20.1 PLC Connection

Serial Connection

PLC Selection on the Editor	CPU	Unit/Port		Signal Level	TS Port	Connection	Ladder Transfer ^{*1}	
MICRO 3	FC2A-Cxxxx	Loader port		RS-232C	COM2	IEDEC cable "FC2A-KC1" +Wiring diagram 1 - COM2	×	
						IEDEC cable "FC2A-KC2" +Wiring diagram 2 - COM2		
		FC2A-LC1		RS-485	COM1	Wiring diagram 1 - COM1		
					COM3	Wiring diagram 1 - COM3		
MICRO Smart	FC4A-Cxxxxx FC4A-Dxxxxx ^{*2 *3}	Port 1	CPU (built-in)	RS-232C	COM2	Wiring diagram 3 - COM2		
						IEDEC cable "FC4A-KC1C" +Wiring diagram 4 - COM2		
						IEDEC cable "FC4A-KC2C" +Wiring diagram 5 - COM2		
		Port 2	FC4A-PC1 FC4A-HPC1	RS-232C	COM2	Wiring diagram 6 - COM2		
						IEDEC cable "FC4A-KC1C" +Wiring diagram 4 - COM2		
						IEDEC cable "FC4A-KC2C" +Wiring diagram 5 - COM2		
						COM1	Wiring diagram 2 - COM1	
						COM3	Wiring diagram 2 - COM3	
						COM1	Wiring diagram 1 - COM1	
						COM3	Wiring diagram 1 - COM3	
MICRO Smart penra	FC5A-Cxxxxx FC5A-Dxxxxx	Port 1	CPU (built-in)	RS-232C	COM2	Wiring diagram 3 - COM2		
						IEDEC cable "FC4A-KC1C" +Wiring diagram 4 - COM2		
						IEDEC cable "FC4A-KC2C" +Wiring diagram 5 - COM2		
		Port 2	FC4A-PC1 FC4A-HPC1	RS-232C	COM2	Wiring diagram 6 - COM2		
						IEDEC cable "FC4A-KC1C" +Wiring diagram 4 - COM2		
						IEDEC cable "FC4A-KC2C" +Wiring diagram 5 - COM2		
						COM1	Wiring diagram 2 - COM1	
						COM3	Wiring diagram 2 - COM3	
						COM1	Wiring diagram 1 - COM1	
						COM3	Wiring diagram 1 - COM3	
		Port 3 to 7	FC5A-SIF2 ^{*4} FC5A-SIF4 ^{*4}	RS-232C	COM2	Wiring diagram 7 - COM2		
						RS-485	COM1	Wiring diagram 1 - COM1
							COM3	Wiring diagram 1 - COM3

*1 For the ladder transfer function, see "Appendix 5 Ladder Transfer Function".

*2 With "FC4A-C10Rxx", only port 1 can be used.

*3 When the communication board "FC4A-PCx" is used with "FX4A-Dxxxxx", IDEC's HMI base module "FC4A-HPH1" is necessary.

*4 "FC5A-C10Rxx" and "FC5A0C16Rxx" cannot be used.

A maximum of 3 units of "FC5A-C24Rxx" or 5 units of "FC5A-Dxxxxx" can be added.

20.1.1 MICRO 3

Communication Setting

Editor

Communication setting

(Underlined setting: default)

Item	Setting	Remarks
Connection Mode	<u>1</u> : 1 / 1 : n / Multi-link2	
Signal Level	<u>RS-232C</u> / RS-422/485	
Baud Rate	4800 / <u>9600</u> / 19200 bps	
Data Length	<u>7</u> / 8 bits	
Stop Bit	<u>1</u> / 2 bits	
Parity	None / Odd / <u>Even</u>	
Target Port No.	<u>0</u> to 31	

PLC

Function setting (communication)

(Underlined setting: default)

Item	Setting	Remarks
Communication Device No. Setting	0	
Loader Port Communication Mode	Arbitrary setting mode	
Communication Condition Selection Input No.	X0000	
Baud Rate	4800 / <u>9600</u> / 19200 bps	
Data Bit	<u>7</u> / 8 bits	
Parity	None / Odd / <u>Even</u>	
Stop Bit	<u>1</u> / 2 bits	
Terminator Code	CR	
Receive Timeout	Make settings in accordance with the network environment.	

Available Memory

The available memory setting range varies depending on the PLC model. Be sure to set within the range available for the PLC. Use [TYPE] when assigning the indirect memory for macro programs.

Memory	TYPE	Remarks
D (data register)	00H	
I (input)	01H	*1
Q (output)	02H	*1
M (internal relay)	03H	*1
R (shift register)	04H	
TS (timer/set value)	05H	
TN (timer/enumerated value)	06H	
T (timer/contact)	07H	Read only
CS (counter/set value)	08H	
CN (counter/enumerated value)	09H	
C (counter/contact)	0AH	Read only

*1 The assigned memory is indicated when editing the screen as shown on the right. The addresses are expressed in "bytes". For word designation, specify an even-numbered address.

Example: M2000



Last one digit: 0 to 7 (octal)
 Other digits: 0 to 9 (decimal)

20.1.2 MICRO Smart

Communication Setting

Editor

Communication setting

Item	Setting	Remarks
Connection Mode	<u>1</u> : <u>1</u> / 1 : n / Multi-link2	
Signal Level	<u>RS-232C</u> / RS-422/485	
Baud Rate	4800 / <u>9600</u> / 19200 bps	
Data Length	<u>7</u> / 8 bits	
Stop Bit	<u>1</u> / 2 bits	
Parity	None / Odd / <u>Even</u>	
Target Port No.	<u>0</u> to 31	

PLC

Function setting (communication)

(Underlined setting: default)

Item	Setting	Remarks
Communication Type	Maintenance communication	
Baud Rate (bps)	4800 / <u>9600</u> / 19200 bps	
Data Bit Length	<u>7</u> / 8 bits	
Parity	None / Odd / <u>Even</u>	
Stop Bit Length	<u>1</u> / 2 bits	
Receive Timeout Time	Make settings in accordance with the network environment.	
Communication Device No.	0	
Communication Selection Input	X0000	

Available Memory

The available memory setting range varies depending on the PLC model. Be sure to set within the range available for the PLC. Use [TYPE] when assigning the indirect memory for macro programs.

Memory	TYPE	Remarks
D (data register)	00H	
I (input)	01H *1	
Q (output)	02H *1	
M (internal relay)	03H *1	
R (shift register)	04H	
TS (timer/set value)	05H	
TN (timer/enumerated value)	06H	
T (timer/contact)	07H	Read only
CS (counter/set value)	08H	
CN (counter/enumerated value)	09H	
C (counter/contact)	0AH	Read only

*1 The assigned memory is indicated when editing the screen as shown on the right. The addresses are expressed in "bytes". For word designation, specify an even-numbered address.

Example: M2000

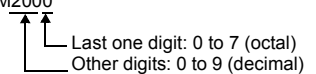

20.1.3 MICRO Smart Pentra

Communication Setting

Editor

Communication setting

Item	Setting	Remarks
Connection Mode	<u>1</u> : 1 / 1 : n / Multi-link2 / Multi-link2 (Ethernet)	
Signal Level	<u>RS-232C</u> / RS-422/485	
Baud Rate	4800 / <u>9600</u> / 19200 / 38400 / 57600 / 115K bps	
Data Length	<u>7</u> / 8 bits	
Stop Bit	<u>1</u> / 2 bits	
Parity	None / Odd / <u>Even</u>	
Target Port No.	<u>0</u> to 31	
Transmission Mode	Little Endian / <u>Big Endian</u>	

PLC

Function setting (communication)

(Underlined setting: default)

Item	Setting	Remarks
Communication Type	Maintenance communication	
Baud Rate (bps)	4800 / <u>9600</u> / 19200 / 38400 / 57600 / 115K bps	For the add-on communication module "FC5A-SIF2", the maximum available rate is 38400 bps. 115 kbps is available only for the add-on communication module "FC5A-SIF4".
Data Bit Length	<u>7</u> / 8 bits	
Parity	None / Odd / <u>Even</u>	
Stop Bit Length	<u>1</u> / 2 bits	
Receive Timeout Time	Make settings in accordance with the network environment.	
Communication Device No.	0	
Communication Selection Input	X0000	

Function setting (other 2)

(Underlined setting: default)

Item	Setting	Remarks
32-bit Data Storage Setting	From lower word / <u>From higher word</u>	From lower word: little endian From higher word: big endian

Available Memory

The available memory setting range varies depending on the PLC model. Be sure to set within the range available for the PLC. Use [TYPE] when assigning the indirect memory for macro programs.

Memory	TYPE	Remarks
D (data register)	00H	
I (input)	01H	*1
Q (output)	02H	*1
M (internal relay)	03H	*1
R (shift register)	04H	
TS (timer/set value)	05H	
TN (timer/enumerated value)	06H	
T (timer/contact)	07H	Read only
CS (counter/set value)	08H	
CN (counter/enumerated value)	09H	
C (counter/contact)	0AH	Read only

*1 The assigned memory is indicated when editing the screen as shown on the right. The addresses are expressed in "bytes". For word designation, specify an even-numbered address.

Example: M2000

↑
↑
Last one digit: 0 to 7 (octal)
Other digits: 0 to 9 (decimal)

20.1.4 Wiring Diagrams

When Connected at COM1:

RS-485

Wiring diagram 1 - COM1

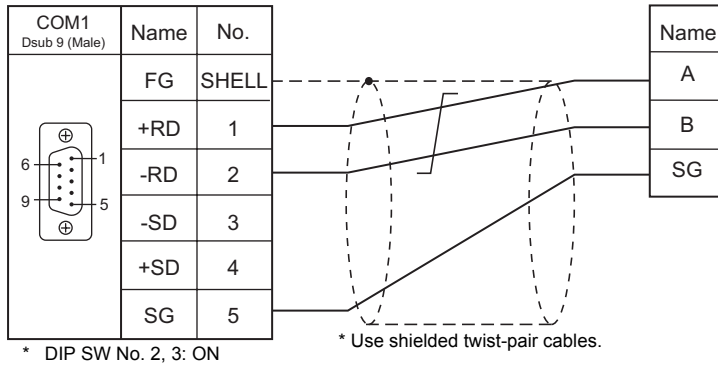

Wiring diagram 2 - COM1

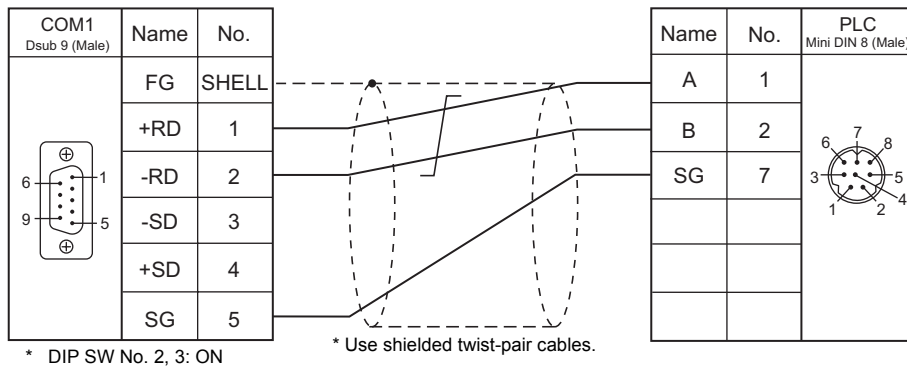

When Connected at COM2:

RS-232C

Wiring diagram 1 - COM2

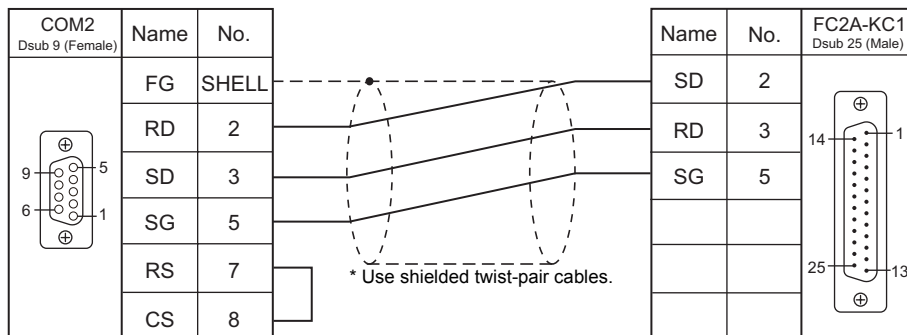

Wiring diagram 2 - COM2

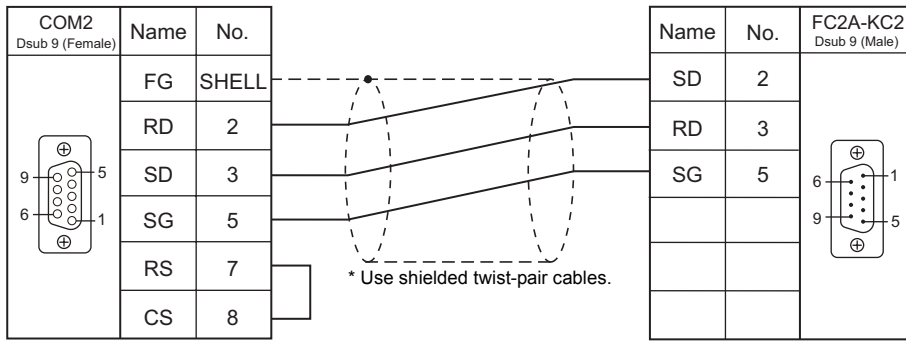

Wiring diagram 3 - COM2

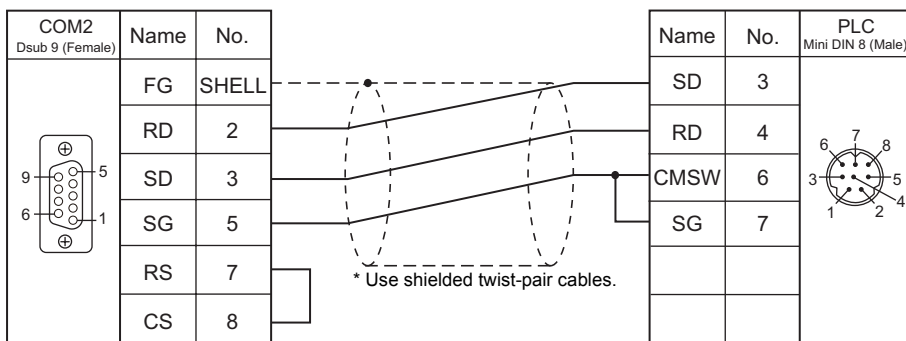

Wiring diagram 4 - COM2

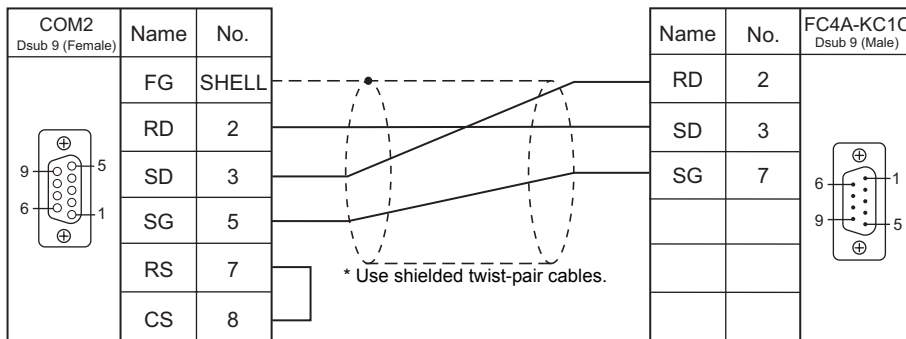

Wiring diagram 5 - COM2

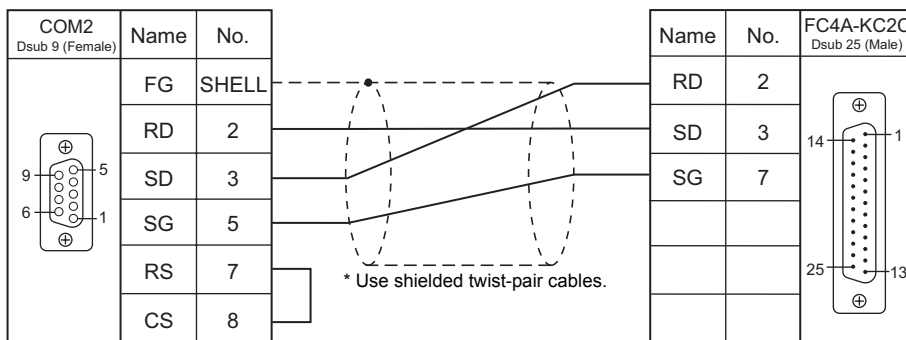

Wiring diagram 6 - COM2

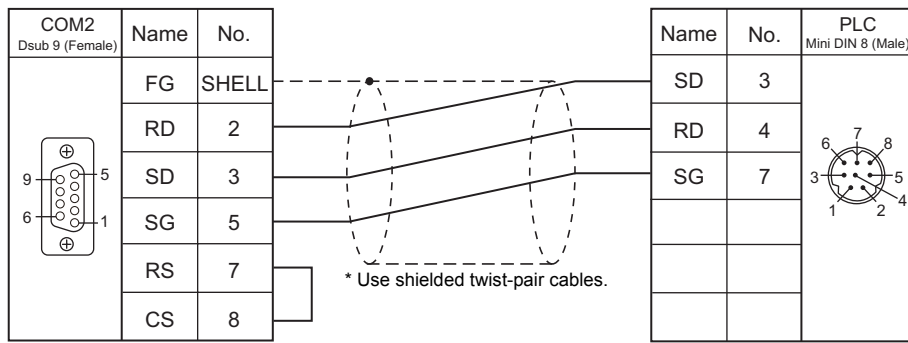

Wiring diagram 7 - COM2

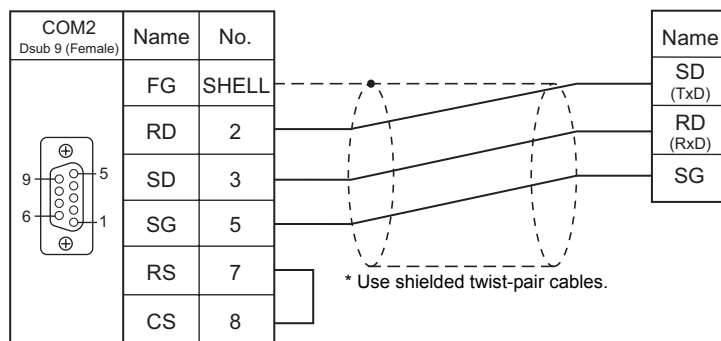

When Connected at COM3:

RS-485

Wiring diagram 1 - COM3

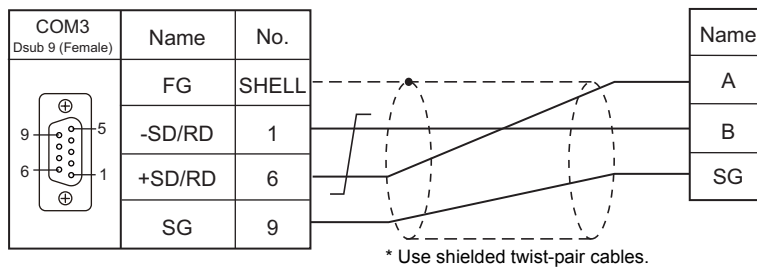

Wiring diagram 2 - COM3

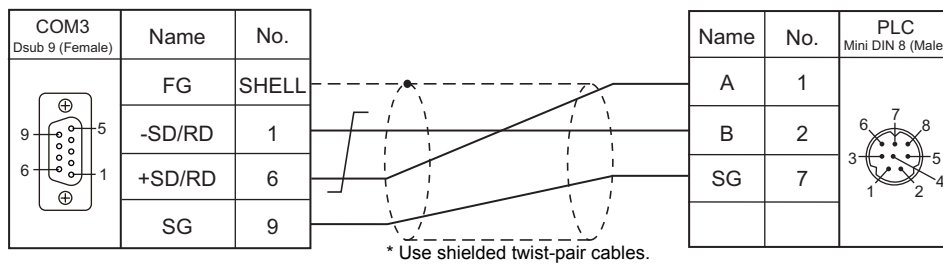

MEMO

Please use this page freely.

21. Jetter

21.1 PLC Connection

21.1 PLC Connection

Ethernet Connection

PLC Selection on the Editor	CPU	Unit	TCP/IP	UDP/IP	Port No.	Ladder Transfer *1
JetControl Series2/3 (Ethernet UDP/IP) *2	JC241 JC243 JC246	Built-in Ethernet (X51)	×	○	50000 (fixed)	×
	JC340 JC350 JC360	Built-in Ethernet (X14/X15)				

*1 For the ladder transfer function, see "Appendix 5 Ladder Transfer Function".

*2 JC24x and JC3x0 can be connected in a mixed manner.

21.1.1 JetControl Series2/3 (Ethernet UDP/IP)

Communication Setting

Editor

Make the following settings on the editor. For more information, see Appendix 2 Ethernet.

- IP address for the TS unit
 - When specified on the screen data:
[System Setting] → [Ethernet Communication] → [Local Port IP Address]
 - When specified on the TS unit:
Main Menu screen → [Ethernet]
- Port No. 50001 on the TS unit
[System Setting] → [Device Connection Setting] → [Communication Setting]

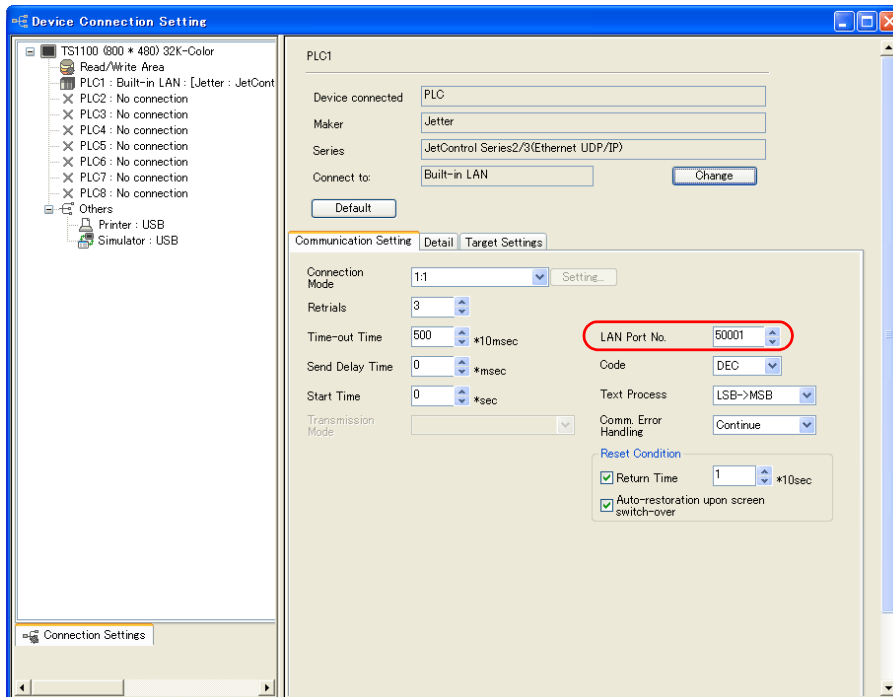

- IP address and port number (No. 50000) for the PLC
[System Setting] → [Device Connection Setting] → [PLC Table]

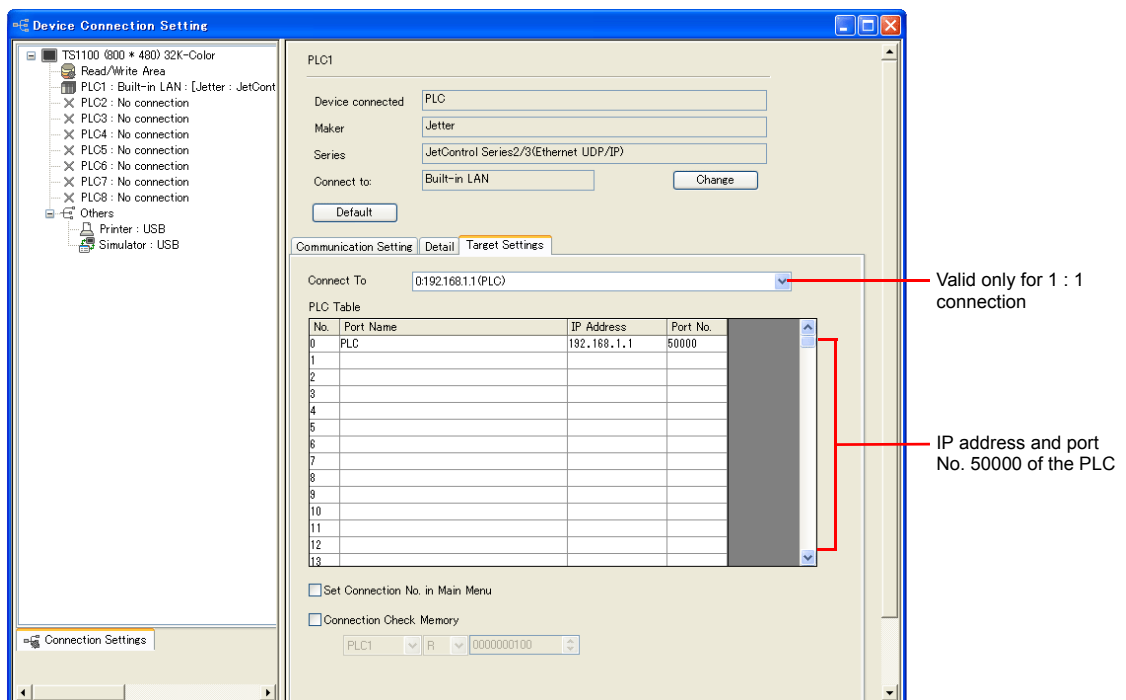

PLC

JC241/JC243/JC246

Set an IP address using the rotary switch or in the “cfgvar.ini” file.
For usage of the “cfgvar.ini” file, refer to the PLC manual issued by the manufacturer.

Rotary switches

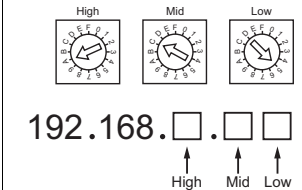
Rotary Switch	Setting	Example
 <p>192.168.□.□.□ ↑ ↑ ↑ High Mid Low</p>	192.168.0.1 to 192.168.15.254	IP address 192.168.10.197 10 (DEC) = A (HEX) 197 (DEC) = C5 (HEX) High = A (HEX), Mid = C (HEX), Low = 5 (HEX) * The IP address is set as “192.168.10.15” on condition that High = 0, Mid = 0, and Low = 0.

Calendar

This model is not equipped with the calendar function. Use the built-in clock of the TS series.

JC340/JC350/JC360

Set an IP address using the DIP switches or in the “Config.ini” file.
For usage of the “Config.ini” file, refer to the PLC manual issued by the manufacturer.

DIP switches

The least significant byte of the IP address can be set by the DIP switches.
The high-order three bytes of the IP address can be set in the “Config.ini” file. For more information, refer to the PLC manual issued by the manufacturer.

DIP Switch	Example	Remarks
 <p>ON 1 2 3 4 5 6 7 8 9 10 11 12 LSB MSB Not used (All OFF)</p>	50 [DEC] (00110010 BIN)	Set the least significant byte of the IP address (1 to 254). Switch 1 = LSB, switch 8 = MSB * When all DIP switches are OFF, the IP address is set as “192.168.10.15”.

Calendar

This model is not equipped with the calendar function. Use the built-in clock of the TS series.

Available Memory

The available memory setting range varies depending on the PLC model. Be sure to set within the range available for the PLC. Use [TYPE] when assigning the indirect memory for macro programs.

Memory	TYPE	Remarks
R (Register)	00H	Double-word
FT (Float)	01H	Real number. Bit designation is not possible.
I (Input)	02H	Read only *1
O (Output)	03H	*1
FG (Flag)	04H	FG0 to FG1048575 valid *1
ST (String)	05H	Double-word, STRING type *2

*1 Use the Register device for word access.

*2 A maximum of 25 bytes is allowed for string display.

Indirect Memory Designation

- For the address number of 0 to 65535:

	15	8	7	0
n+0	Model		Memory type	
n+1	Address No.			
n+2	Expansion code *		Bit designation	
n+3	00		Station number	

- For the address number of 65536 or greater:

	15	8	7	0
n+0	Model		Memory type	
n+1	Lower address No.			
n+2	Higher address No.			
n+3	Expansion code *		Bit designation	
n+4	00		Station number	

- For bit designation, an expansion code setting is required.
00H: when designating bit 0 to 15
01H: when designating bit 16 to 31
- When using Input or Output devices, specify a quotient of "(real address number - 1) divided by 16" for the address number. Specify the remainder for the bit designation.

22. JTEKT

22.1 PLC Connection

22.1 PLC Connection

The PLC models shown below can be connected.

Serial Connection

PLC Selection on the Editor	PLC	Unit/Port	Signal Level	TS Port	Connection	Ladder Transfer ^{*1}
TOYOPUC	PC2 L2	PC/CMP-LINK (TPU-5174)	RS-485	COM1	Wiring diagram 1 - COM1	×
		PC/CMP2-LINK (TPU-5138)				
		3PORT-LINK (TLU-2769)				
		2PORT-LINK (TLU-2695)				
	PC3J/2J	PC/CMP-LINK (THU-2755)				
		PC/CMP2-LINK (THU-5139)				
	PC3J	2PORT-LINK (THU-2927)				
		Built-in link (L1) (TIC-5339)		COM3	Wiring diagram 1 - COM3	
	Optional link (L2) (TIU-5366)					
	PC3JL	Built-in link (L1) (TIC-5783)				
		Optional link (L2) (TIC-5783)				
	PC3JD	Built-in link (L1) (TIC-5642)				

*1 For the ladder transfer function, see "Appendix 5 Ladder Transfer Function".

Ethernet Connection

PLC Selection on the Editor	CPU	Unit/Port	TCP/IP	UDP/IP	Port No.	Keep Alive ^{*2}	Ladder Transfer ^{*3}
TOYOPUC(Ethernet)	PC3J PC2J ^{*1}	FL/ET-T-V2 (THU-5998)	×	○	As desired 1025 to 65534 (Max. 8 units)	○	×
		FL/ET-T-V2H (THU-6289)					
		EN-I/F-T (THU-5781)					
TOYOPUC (Ethernet PC10 mode)	PC10G (version 3.00 or later) PC10GE	Built-in Ethernet (L1/L2)	×	○	As desired 1025 to 65534 (Max. 32 units)	○	×

*1 The PC2J CPU may not be used depending on the CPU version. For more information, refer to the PLC manual issued by the manufacturer.

*2 For KeepAlive functions, see "Appendix 2 Ethernet".

*3 For the ladder transfer function, see "Appendix 5 Ladder Transfer Function".

22.1.1 TOYOPUC

Communication Setting

Editor

Communication setting

(Underlined setting: default)

Item	Setting	Remarks
Connection Mode	<u>1</u> :1 / 1:n / Multi-link / Multi-link2	
Signal Level	RS-422/485	
Baud Rate	4800 / 9600 / <u>19200</u> / 38400 / 57600 / 115k bps	
Parity	<u>Even</u>	
Data Length	<u>7</u> / 8 bits	
Stop Bit	1 / <u>2</u> bits	
Target Port No.	<u>0</u> to 31	
Transmission Mode	<u>Data Area Single</u> / Data Area Division	Select [Data Area Single] for PL2/L2.

PLC

Built-in Link / Optional Link

Hellowin link parameter setting

(Underlined setting: default)

Item	Setting	Remarks
Rack No.	Built-in	
Slot No.	For the built-in link: standard For the optional link: option	
Link Module Name	Computer link	
Station No.	0 to 37 (octal)	
Data Length	<u>7</u> / 8 bits	ASCII
Stop Bit	1 / <u>2</u> bits	
Baud Rate	4800 / 9600 / <u>19200</u> / 38400 / 57600 / 115k bps	
2-wire/4-wire	2-wire system	Can be selected only for "TIC-5783". Set the 2W/4W change-over switch to "2W".

* The parity setting is fixed to even.

TLU-2769 / TLU-2695

Rotary switch

Switch	Setting	Remarks
SW1	0	Station 0 Set the number from 00 to 37 in octal notation. SW1 denotes the higher-order digit, and SW2 denotes the lower-order digit.
SW2	0	
SW3	1	Baud rate 1: 19200, 2: 9600, 3: 4800

Short bar

SET No.	Setting	Contents
SET2	ON	Data length: 7 bits
SET3	ON	Stop bit: 2 bits
SET4	CMP-LINK	Card type: computer link

THU-2755 / THU-5139 / THU-2927

Rotary switch

Switch	Setting	Remarks
SW1	0	Station 0 Set the number from 00 to 37 in octal notation. SW1 denotes the higher-order digit, and SW2 denotes the lower-order digit.
SW2	0	
SW3	1	Baud rate 1: 19200, 2: 9600, 3: 4800

DIP switch

Switch No.	Setting	Contents
SW4-4	ON	Data length: 7 bits
SW4-3	OFF	Stop bit: 2 bits
SW4-2	ON	Module selection: computer link
SW4-1	OFF	2-wire system or not used

Available Memory

The available memory setting range varies depending on the PLC model. Be sure to set within the range available with the PLC to be used. Use [TYPE] when assigning the indirect memory for macro programs.

Memory	TYPE	Remarks
D (data register)	00H	PRG No. when [Data Area Division] is selected
R (link register)	01H	PRG No. when [Data Area Division] is selected
B (file register)	02H	PRG No. when [Data Area Division] is selected
N (current value register)	03H	PRG No. when [Data Area Division] is selected
X (input)	04H	WX as word device
Y (output)	05H	WY as word device
M (internal relay)	06H	WM as word device, PRG No. when [Data Area Division] is selected
K (keep relay)	07H	WK as word device, PRG No. when [Data Area Division] is selected
L (link relay)	08H	WL as word device, PRG No. when [Data Area Division] is selected
T (timer/contact)	09H	WT as word device, PRG No. when [Data Area Division] is selected
C (counter/contact)	0AH	WC as word device, PRG No. when [Data Area Division] is selected
U (extensional data register)	0BH	
H (extensional set value register)	0CH	
EN (extensional current value register)	0DH	
EX (extensional input)	0EH	WEX as word device
EY (extensional output)	0FH	WEY as word device
EM (extensional internal relay)	10H	WEM as word device
EK (extensional keep relay)	11H	WEK as word device
EL (extensional link relay)	12H	WEL as word device
ET (extensional timer/contact)	13H	WET as word device
EC (extensional counter/contact)	14H	WEC as word device
V (special register)	15H	WV as word device

PRG No. setting

If [Transmission Mode: Data Area Division] is set in the [Communication Setting] tab window, specify a program number ([PRG No.]) in addition to memory type and address number. The assigned memory is expressed as shown below when editing the screen. The PRG No. is invalid for the memory in the common area.

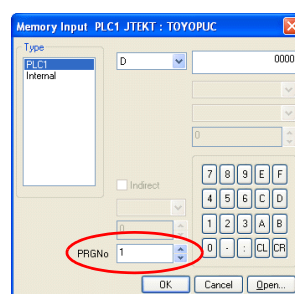
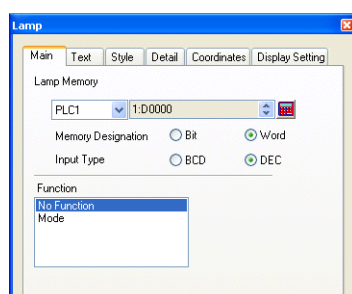

Example: 1: D0000
 ↑ Address number
 ↑ Memory type
 ↑ PRG No.: 1 to 3

Indirect Memory Designation

- For the address number of 0 to 65535:

	15	8 7	0
n+0	Model		Memory type
n+1	Address No.		
n+2	Expansion code *		Bit designation
n+3	00		Station number

- For the address number of 65536 or greater:

	15	8 7	0
n+0	Model		Memory type
n+1	Lower address No.		
n+2	Higher address No.		
n+3	Expansion code *		Bit designation
n+4	00		Station number

- * If [Transmission Mode: Data Area Division] is set in the [Communication Setting] tab window, specify a program number ([PRG No.]) for the expansion code.

Specify the number obtained by subtracting "1" from the actual program number ([PRG No.]) as defined below.

PRG No. 1: 0

PRG No. 2: 1

PRG No. 3: 2

22.1.2 TOYOPUC (Ethernet)

Communication Setting

Editor

Make the following settings on the editor. For more information, see “Appendix 2 Ethernet”.

- IP address for the TS unit
- TS unit's port number in the [Communication Setting] tab window ([System Setting] → [Device Connection Setting])
- PLC's IP address and port number for [PLC Table] in the [Target Settings] tab window ([System Setting] → [Device Connection Setting])

PLC

Hellowin

Settings can be made using the software “Hellowin” or ladder programs. For settings using ladder programs, refer to the PLC manual issued by the manufacturer.

I/O module setting

Item	Setting
Identification Code	B3
Module Type	Special / Communication
Module Name	Time chart module, computer link, Ethernet, S-NET

Link parameter setting

Item	Setting
Rack No.	Select a number where the unit is mounted.
Slot No.	Select a number where the unit is mounted.
Link Module Name	Ethernet

Ethernet setting

Item	Setting
Local Node IP Address	Set the IP address of the PLC.
Connection 1 - 8 *	Protocol: UDP Local Node Port No.: Port number of the PLC Other Node Table No.: Table number for which the TS is registered
Initialization	Initialize using the link parameter

* When multiple TS units are connected, make the settings for each unit. A maximum of eight units can be connected at one time.

Other node table setting

Item	Setting
Table 1 to 16	Check each box for “Use”.
Other Node IP Address	Set the IP address of the TS.
Other Node Port No.	Set the port number of the TS.

Available Memory

The available memory setting range varies depending on the PLC model. Be sure to set within the range available with the PLC to be used. Use [TYPE] when assigning the indirect memory for macro programs.

Memory	TYPE	Remarks
D (data register)	00H	PRG No. when [Data Area Division] is selected
R (link register)	01H	PRG No. when [Data Area Division] is selected
B (file register)	02H	PRG No. when [Data Area Division] is selected
N (current value register)	03H	PRG No. when [Data Area Division] is selected
X (input)	04H	WX as word device
Y (output)	05H	WY as word device
M (internal relay)	06H	WM as word device, PRG No. when [Data Area Division] is selected
K (keep relay)	07H	WK as word device, PRG No. when [Data Area Division] is selected
L (link relay)	08H	WL as word device, PRG No. when [Data Area Division] is selected
T (timer/contact)	09H	WT as word device, PRG No. when [Data Area Division] is selected
C (counter/contact)	0AH	WC as word device, PRG No. when [Data Area Division] is selected
U (extensional data register)	0BH	
H (extensional set value register)	0CH	
EN (extensional current value register)	0DH	
EX (extensional input)	0EH	WEX as word device
EY (extensional output)	0FH	WEY as word device
EM (extensional internal relay)	10H	WEM as word device
EK (extensional keep relay)	11H	WEK as word device
EL (extensional link relay)	12H	WEL as word device
ET (extensional timer/contact)	13H	WET as word device
EC (extensional counter/contact)	14H	WEC as word device
V (special register)	15H	WV as word device

PRG No. setting

If [Transmission Mode: Data Area Division] is set in the [Communication Setting] tab window, specify a program number ([PRG No.]) in addition to memory type and address number. The assigned memory is expressed as shown below when editing the screen. The PRG No. is invalid for the memory in the common area.

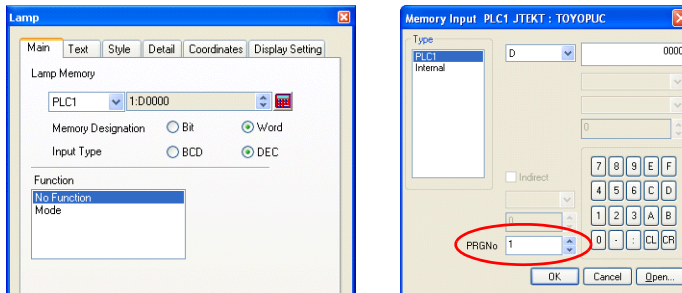

Example: 1: D0000
 ↑ Address number
 ↑ Memory type
 ↑ PRG No.: 1 to 3

Indirect Memory Designation

- For the address number of 0 to 65535:

	15	8 7	0
n+0	Model		Memory type
n+1	Address No.		
n+2	Expansion code *		Bit designation
n+3	00		Station number

- For the address number of 65536 or greater:

	15	8 7	0
n+0	Model		Memory type
n+1	Lower address No.		
n+2	Higher address No.		
n+3	Expansion code *		Bit designation
n+4	00		Station number

* If [Transmission Mode: Data Area Division] is set in the [Communication Setting] tab window, specify a program number ([PRG No.]) for the expansion code.

Specify the number obtained by subtracting "1" from the actual program number ([PRG No.]) as defined below.

- PRG No. 1: 0
- PRG No. 2: 1
- PRG No. 3: 2

22.1.3 TOYOPUC (Ethernet PC10 Mode)

Communication Setting

Editor

Make the following settings on the editor. For more information, see “Appendix 2 Ethernet”.

- IP address for the TS unit
- TS unit's port number in the [Communication Setting] tab window ([System Setting] → [Device Connection Setting])
- PLC's IP address and port number for [PLC Table] in the [Target Settings] tab window ([System Setting] → [Device Connection Setting])

PLC

Settings are possible either in the software “PCwin” or ladder programs. For settings using ladder programs, refer to the PLC manual issued by the manufacturer.

Communication Setting Switches L1 and L2

SW	No.	Item	Setting
	1	L3 SN-IF use setting	OFF: Not used (T-OFF)
	2	L1 communication setting	ON: Link parameter (L1 SEL.)
	3	L2 baud rate switching	ON: Auto negotiation (L2 Auto) OFF: 10M bps (10M)
	4	L1 baud rate switching	ON: Auto negotiation (L1 Auto) OFF: 10M bps (10M)

PCwin

Link parameter setting

Item	Setting
Rack No.	Built-in
Slot No.	L1 / L2
Link Module Name	Ethernet (32 ports)

Ethernet setting

Item	Setting
Local Node IP Address	Set the IP address of the PLC.
Setting 1/Setting 2/ Setting 3/Setting 4/	Setting 1: Connection 1 to 8 Setting 2: Connection 9 to 16 Setting 3: Connection 17 to 24 Setting 4: Connection 25 to 32
Connection 1 - 32 *	Protocol: UDP Local Node Port No.: Port number of the PLC Other Node Table No.: Table number for which the TS is registered
Initialization	Initialize using the link parameter

* When multiple TS units are connected, make the settings for each unit. A maximum of 32 units can be connected at one time.

Other node table setting

Item	Setting
Setting 1/Setting 2	Setting 1: Table 1 to 16 Setting 2: Table 17 to 32
Table 1 to 32	Check each box for “Use”.
Other Node IP Address	Set the IP address of the TS.
Other Node Port No.	Set the port number of the TS.

If "TOYOPUC (Ethernet PC10 mode)" is selected as a connected model in V-SFT and if establishing communication with PC10G or PC10GE is intended, set the following dialogs.

- PC10G: PC10 mode
- PC10GE: PC10 extended mode

PCwin settings

Click [Option] → [Setting] → [Interchangeable]. In the tab window, check either box below.

- PC10G: Check PC10 mode].
- PC10GE: Check PC10 extended mode].

In the [CPU operation mode] dialog, check either [PC10 mode] or [PC10 Extension].

Available Memory

The available memory setting range varies depending on the PLC model. Be sure to set within the range available for the PLC.

Use [TYPE] when assigning the indirect memory for macro programs.

Memory	TYPE	Remarks
D (data register)	00H	PRG No. designation
R (link register)	01H	PRG No. designation
N (current value register)	03H	PRG No. designation
X (input)	04H	WX as word device
Y (output)	05H	WY as word device
M (internal relay)	06H	WM as word device, PRG No. designation
K (keep relay)	07H	WK as word device, PRG No. designation
L (link relay)	08H	WL as word device, PRG No. designation
T (timer/contact)	09H	WT as word device, PRG No. designation
C (counter/contact)	0AH	WC as word device, PRG No. designation
U (extension data register)	0BH	
H (extension set value register)	0CH	
EN (extension current value register)	0DH	
EX (extension input)	0EH	WEX as word device
EY (extension output)	0FH	WEY as word device
EM (extension internal relay)	10H	WEM as word device
EK (extension keep relay)	11H	WEK as word device
EL (extension link relay)	12H	WEL as word device
ET (extension timer/contact)	13H	WET as word device
EC (extension counter/contact)	14H	WEC as word device
V (special relay)	15H	WV as word device, PRG No. designation, read only
GX (extension input)	16H	WGX as word device
GY (extension output)	17H	WGY as word device
GM (extension internal relay)	18H	WGM as word device
EB (extension buffer register)	19H	
FR (extension flash register)	1AH	

PRG No. setting

In addition to memory type and address number, a program number ([PRG No.]) must be specified. The assigned memory is expressed as shown below when editing the screen. The PRG No. is invalid for the memory in the common area.

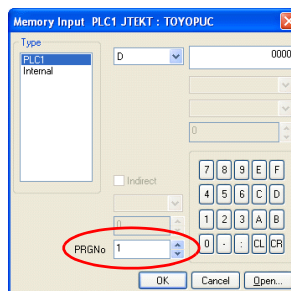
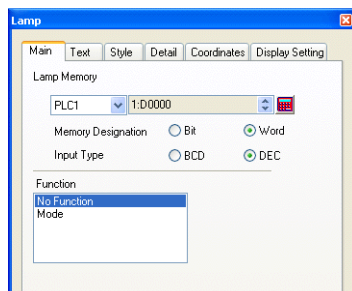

Example: 1: D0000
 ↑ Address number
 ↑ Memory type
 ↑ PRG No.: 1 to 3

Indirect Memory Designation

- For the address number of 0 to 65535:

n+0	15	8	7	0
	Model		Memory type	
n+1	Address No.			
n+2	Expansion code *		Bit designation	
n+3	00		Station number	

- For the address number of 65536 or greater:

n+0	15	8	7	0
	Model		Memory type	
n+1	Lower address No.			
n+2	Higher address No.			
n+3	Expansion code *		Bit designation	
n+4	00		Station number	

* Specify a program number ([PRG No.]) for the expansion code. Specify the number obtained by subtracting "1" from the actual program number ([PRG No.]) as defined below.

- PRG No. 1: 0
- PRG No. 2: 1
- PRG No. 3: 2

PLC_CTL

Macro command "PLC_CTL F0 F1 F2"

Contents	F0	F1 (= \$u n)	F2																								
Write to FR register flash memory *	1 to 8 (PLC1 to 8)	n	Station number																								
		n+1	Command: 0																								
		n+2	ExNo. (HEX) <table border="1" style="margin-left: 20px;"> <thead> <tr> <th>ExNo.</th> <th>Address</th> </tr> </thead> <tbody> <tr> <td>40H</td> <td>FR000000 to FR007FFF</td> </tr> <tr> <td>41H</td> <td>FR008000 to FR00FFFF</td> </tr> <tr> <td>42H</td> <td>FR010000 to FR017FFF</td> </tr> <tr> <td>43H</td> <td>FR018000 to FR01FFFF</td> </tr> <tr> <td>:</td> <td>:</td> </tr> <tr> <td>:</td> <td>:</td> </tr> <tr> <td>7EH</td> <td>FR1F0000 to FR1F7FFF</td> </tr> <tr> <td>7FH</td> <td>FR1F8000 to FR1FFFFF</td> </tr> </tbody> </table>	ExNo.	Address	40H	FR000000 to FR007FFF	41H	FR008000 to FR00FFFF	42H	FR010000 to FR017FFF	43H	FR018000 to FR01FFFF	:	:	:	:	7EH	FR1F0000 to FR1F7FFF	7FH	FR1F8000 to FR1FFFFF						
		ExNo.	Address																								
40H	FR000000 to FR007FFF																										
41H	FR008000 to FR00FFFF																										
42H	FR010000 to FR017FFF																										
43H	FR018000 to FR01FFFF																										
:	:																										
:	:																										
7EH	FR1F0000 to FR1F7FFF																										
7FH	FR1F8000 to FR1FFFFF																										
n+3	Execution result 0: Successful 1: Error 2: Writing																										
CPU status readout	1 to 8 (PLC1 to 8)	n	Station number																								
		n+1	Command: 1																								
		n+2	Data 1 <table border="1" style="margin-left: 20px;"> <tr> <td>15</td><td>~</td><td>8</td><td>7</td><td>6</td><td>5</td><td>4</td><td>3</td><td>2</td><td>1</td><td>0</td> </tr> <tr> <td colspan="2">0 fixed</td> <td rowspan="2">Running</td> <td rowspan="2">Stopped</td> <td rowspan="2">Stop request continued</td> <td rowspan="2">Pseudo stop</td> <td rowspan="2">Debug mode</td> <td rowspan="2">I/O monitor user mode</td> <td rowspan="2">PC3 mode</td> <td rowspan="2">PC10 mode</td> <td rowspan="2">Test mode</td> </tr> <tr> <td colspan="2"></td> </tr> </table>	15	~	8	7	6	5	4	3	2	1	0	0 fixed		Running	Stopped	Stop request continued	Pseudo stop	Debug mode	I/O monitor user mode	PC3 mode	PC10 mode	Test mode		
		15	~	8	7	6	5	4	3	2	1	0															
0 fixed		Running	Stopped	Stop request continued	Pseudo stop	Debug mode	I/O monitor user mode	PC3 mode	PC10 mode	Test mode																	
n+3	Data 2 <table border="1" style="margin-left: 20px;"> <tr> <td>15</td><td>~</td><td>8</td><td>7</td><td>6</td><td>5</td><td>4</td><td>3</td><td>2</td><td>1</td><td>0</td> </tr> <tr> <td colspan="2">0 fixed</td> <td rowspan="2">Severe failure</td> <td rowspan="2">Minor failure</td> <td rowspan="2">Alarm</td> <td rowspan="2">With memory card</td> <td rowspan="2">I/O assignment parameter changed</td> <td rowspan="2">Test mode</td> <td colspan="3"></td> </tr> <tr> <td colspan="2"></td> </tr> </table>	15	~	8	7	6	5	4	3	2	1	0	0 fixed		Severe failure	Minor failure	Alarm	With memory card	I/O assignment parameter changed	Test mode							
15	~	8	7	6	5	4	3	2	1	0																	
0 fixed		Severe failure	Minor failure	Alarm	With memory card	I/O assignment parameter changed	Test mode																				

Contents	F0	F1 (= \$u n)	F2
CPU status readout	1 to 8 (PLC1 to 8)	<p>n+4</p> <p>Data 3</p>	2
		<p>n+5</p> <p>Data 4</p>	
		<p>n+6</p> <p>Data 5</p>	
		<p>n+7</p> <p>Data 6</p>	
		<p>n+8</p> <p>Data 7</p>	
		<p>n+9</p> <p>Data 8</p>	

Return data: Data stored to TS series from PC10G

* Writing to the FR register flash memory is performed in units of 64 KB. When writing to addresses in memory, specify an "Ex No." corresponding to the desired addresses for 64 KB of data. Communication between the TS series and PC10G pauses during writing.

22.1.4 Wiring Diagrams

When Connected at COM1:

RS-485

Wiring diagram 1 - COM1

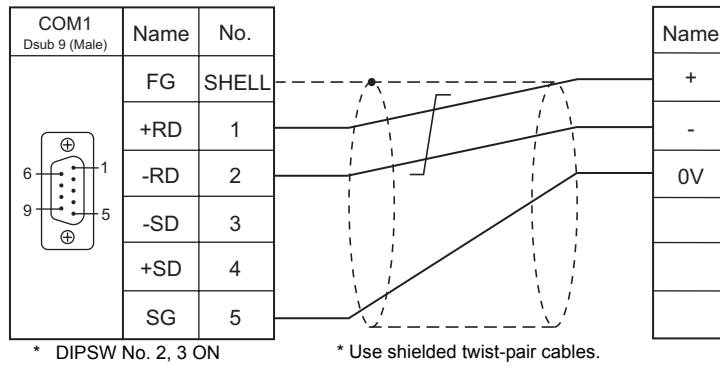

When Connected at COM3:

RS-485

Wiring diagram 1 - COM3

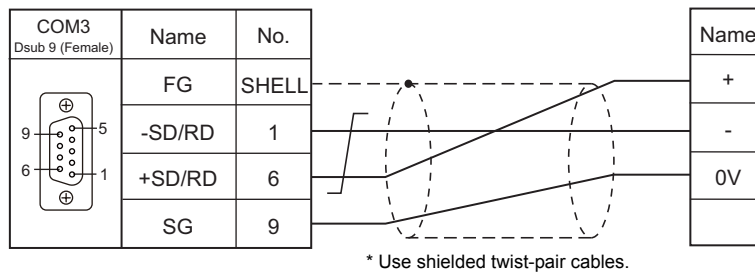

MEMO

Please use this page freely.

23. KEYENCE

23.1 PLC Connection

23.1 PLC Connection

Serial Connection

PLC Selection on the Editor	CPU	Unit/Port		Signal Level	TS Port	Connection	Ladder Transfer ^{*1}
KZ-A500 CPU	KZ-A500	CPU modular port		RS-232C	COM2	Wiring diagram 1 - COM2	×
KV10/24 CPU	KV-10 KV-24 KV-40	CPU modular port		RS-232C	COM2	Wiring diagram 2 - COM2	
						Hakko Electronics "D9-KI2-KV-2M" + Gender changer	
KV-700	KV-700	CPU modular port		RS-232C	COM2	Wiring diagram 2 - COM2	
						Hakko Electronics "D9-KI2-KV-2M" + Gender changer	
		KV-L20 KV-L20R	Port 1	RS-232C	COM2	Wiring diagram 3 - COM2	
			Port 2	RS-232C	COM2	Wiring diagram 4 - COM2	
		RS-422	COM1	Wiring diagram 1 - COM1			
KV-1000	KV-1000	CPU modular port		RS-232C	COM2	Wiring diagram 2 - COM2	
						Hakko Electronics "D9-KI2-KV-2M" + Gender changer	
		KV-L20R	Port 1	RS-232C	COM2	Wiring diagram 3 - COM2	
			Port 2	RS-232C	COM2	Wiring diagram 4 - COM2	
		RS-422	COM1	Wiring diagram 1 - COM1			
KV-3000/5000	KV-3000	CPU modular port		RS-232C	COM2	Wiring diagram 2 - COM2	
						Hakko Electronics "D9-KI2-KV-2M" + Gender changer	
	KV-3000 KV-5000	KV-L20V	Port 1	RS-232C	COM2	Wiring diagram 3 - COM2	
			Port 2	RS-232C	COM2	Wiring diagram 4 - COM2	
		RS-422	COM1	Wiring diagram 1 - COM1			

*1 For the ladder transfer function, see "Appendix 5 Ladder Transfer Function".

Ethernet Connection

PLC Selection on the Editor	CPU	Unit	TCP/IP	UDP/IP	Port No.	Ladder Transfer ^{*1}
KV-700 (Ethernet TCP/IP)	KV-700	KV-LE20	○	×	8500	×
KV-1000 (Ethernet TCP/IP)	KV-1000		○	×	8500	
KV-3000/5000 (Ethernet TCP/IP)	KV-3000 KV-5000	KV-LE20V	○	×	8500	
	KV-5000	CPU (built-in)				

*1 For the ladder transfer function, see "Appendix 5 Ladder Transfer Function".

23.1.1 KZ-A500 CPU

Communication Setting

Editor

Communication setting

(Underlined setting: default)

Item	Setting	Remarks
Connection Mode	<u>1:1</u> / Multi-link2	
Signal Level	RS-232C	
Baud Rate	4800 / <u>9600</u> / 19200 / 38400 bps	
Data Length	8 bits	
Stop Bit	1 bit	
Parity	Odd	

PLC

Port setting switch

SW1	SW2	Baud Rate
ON	OFF	4800 bps
OFF	OFF	9600 bps
OFF	ON	19200 bps
ON	ON	38400 bps

Available Memory

The available memory setting range varies depending on the PLC model. Be sure to set within the range available for the PLC. Use [TYPE] when assigning the indirect memory for macro programs.

Memory	TYPE	Remarks
D (data register)	00H	
W (link register)	01H	
R (file register)	02H	
TN (timer/current value)	03H	
CN (counter/current value)	04H	
M (internal relay)	06H	
L (latch relay)	07H	
B (link relay)	08H	
X (input)	09H	
Y (output)	0AH	
TS (timer/contact)	0BH	
TC (timer/coil)	0CH	
CS (counter/contact)	0DH	
CC (counter/coil)	0EH	

23.1.2 KV10/24 CPU

Communication Setting

Editor

Communication setting

(Underlined setting: default)

Item	Setting	Remarks
Connection Mode	<u>1:1</u> / Multi-link2	
Signal Level	RS-232C	
Baud Rate	9600 / 19200 / 38400 / <u>57600</u> bps	If a baud rate higher than 57600 bps is set, communication is performed at 9600 bps.
Data Length	8 bits	
Stop Bit	1 bit	
Parity	Even	
Target Port No.	0	

PLC

No particular setting is necessary on the PLC.

Available Memory

The available memory setting range varies depending on the PLC model. Be sure to set within the range available for the PLC. Use [TYPE] when assigning the indirect memory for macro programs.

Memory	TYPE	Remarks
DM (data memory)	00H	
CH (input/output/internal auxiliary relay)	01H	
TC (timer/current value)	02H	
CC (counter/current value)	03H	
TS (timer/set value)	04H	
CS (counter/set value)	05H	
T (timer/contact)	06H	
C (counter/contact)	07H	
TM (temporary data memory)	08H	

23.1.3 KV-700

Communication Setting

Editor

Communication setting

(Underlined setting: default)

Item	Setting	Remarks
Connection Mode	<u>1:1</u> / Multi-link2	
Signal Level	<u>RS-232C</u> / RS-422/485	
Baud Rate	9600 / 19200 / 38400 / <u>57600</u> bps	
Data Length	8 bits	
Stop Bit	1 bit	
Parity	Even	
Target Port No.	<u>0</u> to 31	

PLC

KV-700 (CPU Modular Port)

No particular setting is necessary on the PLC.

KV-L20

Unit editor setting

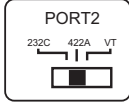
Port	Item	Setting	Remarks
Port 1	Operation Mode	KV BUILDER Mode	
	RS/CS Flow Control	No	
Port 2	Operation Mode	KV BUILDER Mode	
	Interface	RS-232C / RS-422A	Change the setting using the PORT 2 selector switch attached to the side. 
	Station No.	0 to 9	

* These settings can be checked on the access window of the CPU. For more information, refer to the PLC manual issued by the manufacturer.

KV-L20R

Unit editor setting

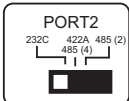
Port	Item	Setting	Remarks
Basic Port	Station No.	0 to 9	Common to Port 1 and 2.
Port 1	Operation Mode	KV BUILDER/KV STUDIO Mode	
	RS/CS Flow Control	No	
Port 2	Operation Mode	KV BUILDER/KV STUDIO Mode	
	Interface	RS-232C/RS-422A/485 (4-wire system)	PORT 2 selector switch attached to the side 

* These settings can be checked on the access window of the CPU. For more information, refer to the PLC manual issued by the manufacturer.

Available Memory

The available memory setting range varies depending on the PLC model. Be sure to set within the range available for the PLC. Use [TYPE] when assigning the indirect memory for macro programs.

Memory	TYPE	Remarks
DM (data memory)	00H	
R (input/output/internal auxiliary/special relay)	01H	
TC (timer/current value)	02H	
CC (counter/current value)	03H	
TS (timer/set value)	04H	
CS (counter/set value)	05H	
T (timer/contact)	06H	
C (counter/contact)	07H	
TM (temporary data memory)	08H	
CTH (high-speed counter/current value)	09H	
CTC (high-speed counter comparator/set value)	0AH	
CT (high-speed counter comparator/contact)	0BH	
CR (control relay)	0CH	
CM (control memory)	0DH	

23.1.4 KV-700 (Ethernet TCP/IP)

Communication Setting

Editor

Make the following settings on the editor. For more information, see “Appendix 2 Ethernet”.

- IP address for the TS unit
- TS unit's port number in the [Communication Setting] tab window ([System Setting] → [Device Connection Setting])
- PLC's IP address and port number for [PLC Table] in the [Target Settings] tab window ([System Setting] → [Device Connection Setting])

PLC

KV-LE20

Unit editor setting

Item	Setting	Remarks
Baud Rate	<u>100/10 Mbps Auto</u> / 10 Mbps	Set to “10 Mbps” (fixed) if the communication status is unstable.
IP Address	0.0.0.0 to 255.255.255.255	
Subnet Mask	0.0.0.0 to 255.255.255.255	
Port Number (KVS, DB)	<u>8500</u>	TCP/IP

* These settings can be checked on the access window of the CPU. For more information, refer to the PLC manual issued by the manufacturer.

Available Memory

The available memory setting range varies depending on the PLC model. Be sure to set within the range available for the PLC. Use [TYPE] when assigning the indirect memory for macro programs.

Memory	TYPE	Remarks
DM (data memory)	00H	
R (input/output/internal auxiliary/special relay)	01H	
TC (timer/current value)	02H	
CC (counter/current value)	03H	
TS (timer/set value)	04H	
CS (counter/set value)	05H	
T (timer/contact)	06H	
C (counter/contact)	07H	
TM (temporary data memory)	08H	
CTH (high-speed counter/current value)	09H	
CTC (high-speed counter comparator/set value)	0AH	
CT (high-speed counter comparator/contact)	0BH	
CR (control relay)	0CH	
CM (control memory)	0DH	

23.1.5 KV-1000

Communication Setting

Editor

Communication setting

(Underlined setting: default)

Item	Setting	Remarks
Connection Mode	<u>1:1</u> / Multi-link2	
Signal Level	<u>RS-232C</u> / RS-422/485	
Baud Rate	9600 / 19200 / 38400 / 57600 / <u>115K</u> bps	
Data Length	8 bits	
Stop Bit	1 bit	
Parity	Even	
Target Port No.	<u>0</u> to 31	

PLC

KV-1000 (CPU Modular Port)

No particular setting is necessary on the PLC.

KV-L20R

Unit editor setting

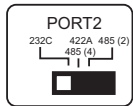
Port	Item	Setting	Remarks
Basic Port	Station No.	0 to 9	Common to Port 1 and 2.
Port 1	Operation Mode	KV BUILDER/KV STUDIO Mode	
	RS/CS Flow Control	No	
Port 2	Operation Mode	KV BUILDER/KV STUDIO Mode	
	Interface	RS-232C/ RS-422A/485 (4-wire system)	PORT 2 selector switch attached to the side 

* These settings can be checked on the access window of the CPU. For more information, refer to the PLC manual issued by the manufacturer.

Available Memory

The available memory setting range varies depending on the PLC model. Be sure to set within the range available for the PLC. Use [TYPE] when assigning the indirect memory for macro programs.

Memory	TYPE	Remarks
DM (data memory)	00H	
R (input/output/internal auxiliary/special relay)	01H	
TC (timer/current value)	02H	
CC (counter/current value)	03H	
TS (timer/set value)	04H	
CS (counter/set value)	05H	
T (timer/contact)	06H	
C (counter/contact)	07H	
TM (temporary data memory)	08H	
CTH (high-speed counter/current value)	09H	
CTC (high-speed counter comparator/set value)	0AH	
CT (high-speed counter comparator/contact)	0BH	
CR (control relay)	0CH	
CM (control memory)	0DH	
MR (internal auxiliary relay)	0EH	
LR (latch relay)	0FH	
EM (extended data memory 1)	10H	
FM (extended data memory 2)	11H	
Z (index register)	12H	

23.1.6 KV-1000 (Ethernet TCP/IP)

Communication Setting

Editor

Make the following settings on the editor. For more information, see “Appendix 2 Ethernet”.

- IP address for the TS unit
- TS unit's port number in the [Communication Setting] tab window ([System Setting] → [Device Connection Setting])
- PLC's IP address and port number for [PLC Table] in the [Target Settings] tab window ([System Setting] → [Device Connection Setting] → [Target Settings])

PLC

The communication setting is the same as the one described in “23.1.4 KV-700 (Ethernet TCP/IP)”.

Available Memory

The available memory setting range varies depending on the PLC model. Be sure to set within the range available for the PLC. Use [TYPE] when assigning the indirect memory for macro programs.

Memory	TYPE	Remarks
DM (data memory)	00H	
R (input/output/internal auxiliary/special relay)	01H	
TC (timer/current value)	02H	
CC (counter/current value)	03H	
TS (timer/set value)	04H	
CS (counter/set value)	05H	
T (timer/contact)	06H	
C (counter/contact)	07H	
TM (temporary data memory)	08H	
CTH (high-speed counter/current value)	09H	
CTC (high-speed counter comparator/set value)	0AH	
CT (high-speed counter comparator/contact)	0BH	
CR (control relay)	0CH	
CM (control memory)	0DH	
MR (internal auxiliary relay)	0EH	
LR (latch relay)	0FH	
EM (extended data memory 1)	10H	
FM (extended data memory 2)	11H	
Z (index register)	12H	

23.1.7 KV-3000 / 5000

Communication Setting

Editor

Communication setting

(Underlined setting: default)

Item	Setting	Remarks
Connection Mode	<u>1:1</u> / Multi-link2	
Signal Level	<u>RS-232C</u> / RS-422/485	
Baud Rate	9600 / 19200 / 38400 / 57600 / <u>115K</u> bps	
Data Length	8 bits	
Stop Bit	1 bit	
Parity	Even	
Target Port No.	<u>Q</u> to 31	

PLC

KV-3000 (CPU Modular Port)

No particular setting is necessary on the PLC.

KV-L20V

Unit editor setting

Port	Item	Setting	Remarks
Basic Port	Station number	0 to 9	Common to Port 1 and 2.
Port 1	Operation mode	KV BUILDER/KV STUDIO mode	
	RS/CS flow control	No	
Port 2	Operation mode	KV BUILDER/KV STUDIO mode	
	Interface	RS-232C/ RS-422A/485 (4-wire system)	

* These settings can be checked on the access window of the CPU. For more information, refer to the PLC manual issued by the manufacturer.

Available Memory

The available memory setting range varies depending on the PLC model. Be sure to set within the range available for the PLC. Use [TYPE] when assigning the indirect memory for macro programs.

Memory	TYPE	Remarks
DM (data memory)	00H	
R (input/output/internal auxiliary/special relay)	01H	
TC (timer/current value)	02H	Double-word
CC (counter/current value)	03H	Double-word
TS (timer/set value)	04H	Double-word
CS (counter/set value)	05H	Double-word
T (timer/contact)	06H	
C (counter/contact)	07H	
TM (temporary data memory)	08H	
CTH (high-speed counter/current value)	09H	Double-word
CTC (high-speed counter comparator/set value)	0AH	Double-word
CT (high-speed counter comparator/contact)	0BH	
CR (control relay)	0CH	
CM (control memory)	0DH	
MR (internal auxiliary relay)	0EH	
LR (latch relay)	0FH	
EM (extended data memory 1)	10H	
FM (extended data memory 2)	11H	
Z (index register)	12H	Double-word
B (link relay)	13H	
VB (work relay)	14H	
ZF (file register)	15H	
W (link register)	16H	
VM (work memory)	17H	

23.1.8 KV-3000 / 5000 (Ethernet TCP/IP)

Communication Setting

Editor

Make the following settings on the editor. For more information, see “Appendix 2 Ethernet”.

- IP address for the TS unit
- TS unit's port number in the [Communication Setting] tab window ([System Setting] → [Device Connection Setting])
- PLC's IP address and port number for [PLC Table] in the [Target Settings] tab window ([System Setting] → [Device Connection Setting] → [Target Settings])

PLC

The communication setting is the same as the one described in “23.1.4 KV-700 (Ethernet TCP/IP)”.

Available Memory

The available memory setting range varies depending on the PLC model. Be sure to set within the range available for the PLC. Use [TYPE] when assigning the indirect memory for macro programs.

Memory	TYPE	Remarks
DM (data memory)	00H	
R (input/output/internal auxiliary/special relay)	01H	
TC (timer/current value)	02H	Double-word
CC (counter/current value)	03H	Double-word
TS (timer/set value)	04H	Double-word
CS (counter/set value)	05H	Double-word
T (timer/contact)	06H	
C (counter/contact)	07H	
TM (temporary data memory)	08H	
CTH (high-speed counter/current value)	09H	Double-word
CTC (high-speed counter comparator/set value)	0AH	Double-word
CT (high-speed counter comparator/contact)	0BH	
CR (control relay)	0CH	
CM (control memory)	0DH	
MR (internal auxiliary relay)	0EH	
LR (latch relay)	0FH	
EM (extended data memory 1)	10H	
FM (extended data memory 2)	11H	
Z (index register)	12H	Double-word
B (link relay)	13H	
VB (work relay)	14H	
ZF (file register)	15H	
W (link register)	16H	
VM (work memory)	17H	

23.1.9 Wiring Diagrams

When Connected at COM1:

RS-422

Wiring diagram 1 - COM1

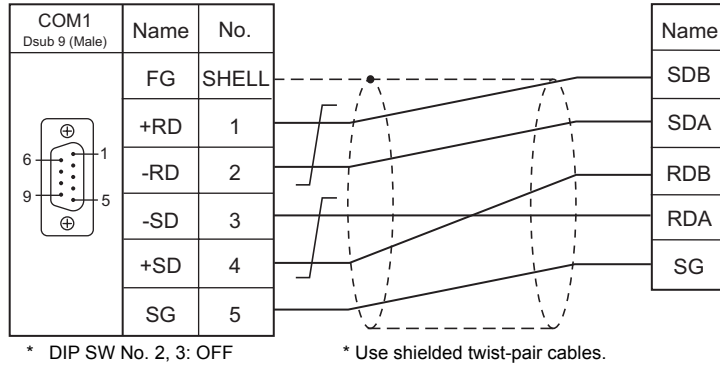

When Connected at COM2:

RS-232C

Wiring diagram 1 - COM2

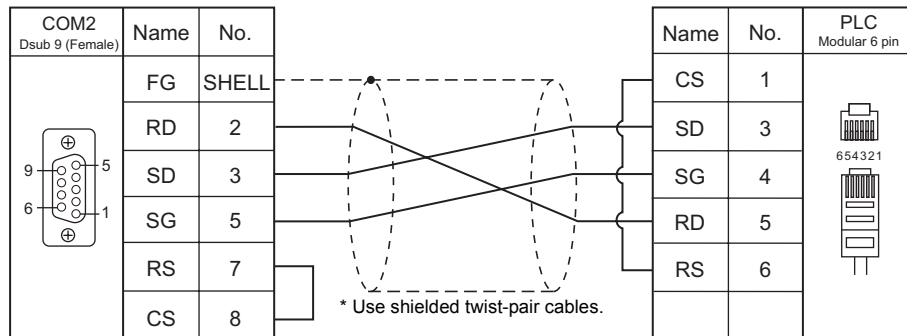

Wiring diagram 2 - COM2

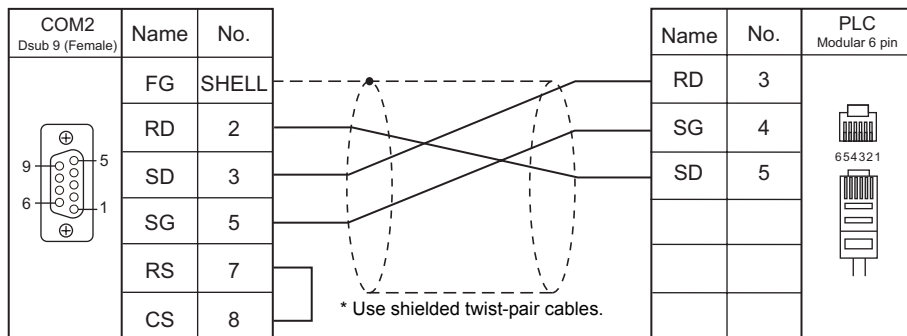

Wiring diagram 3 - COM2

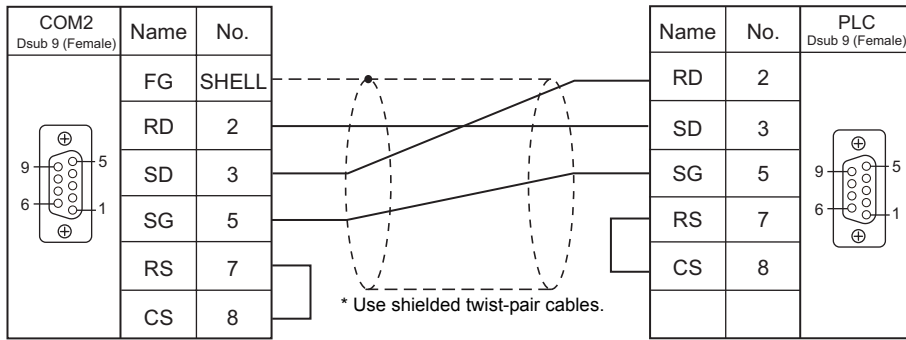

Wiring diagram 4 - COM2

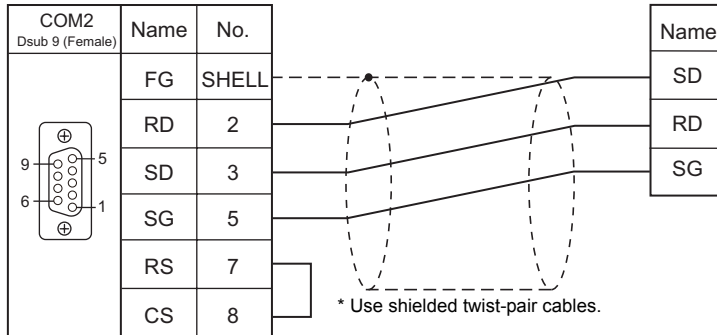

24. KOYO ELECTRONICS

24.1 PLC Connection

24.1 PLC Connection

Serial Connection

PLC Selection on the Editor	PLC	Port	Signal Level	TS Port	Connection	Ladder Transfer ^{*1}		
SU/SG series	SU-5	U-01DM	RS-232C	COM2	Wiring diagram 1 - COM2	×		
			RS-422	COM1	Wiring diagram 4 - COM1			
	SU-5E SU-6B SU-6H	Universal communication port	RS-232C	COM2	Wiring diagram 1 - COM2			
			RS-422	COM1	Wiring diagram 1 - COM1			
		U-01DM	RS-232C	COM2	Wiring diagram 1 - COM2			
			RS-422	COM1	Wiring diagram 4 - COM1			
	SU-5M SU-6M	Universal communication port 1	RS-232C	COM2	Wiring diagram 1 - COM2			
			RS-422	COM1	Wiring diagram 1 - COM1			
		Universal communication port 2	RS-232C	COM2	Wiring diagram 3 - COM2			
		Universal communication port 3	RS-422	COM1	Wiring diagram 2 - COM1			
		U-01DM	RS-232C	COM2	Wiring diagram 1 - COM2			
			RS-422	COM1	Wiring diagram 4 - COM1			
	SZ-4	Universal communication port (PORT2)	RS-232C	COM2	Wiring diagram 3 - COM2			
	SZ-4M	Universal communication port (PORT2)	RS-232C	COM2	Wiring diagram 2 - COM2			
			RS-422	COM1	Wiring diagram 3 - COM1			
	SG-8	Universal communication port	RS-232C	COM2	Wiring diagram 1 - COM2			
			RS-422	COM1	Wiring diagram 1 - COM1			
		G-01DM (CN2)	RS-232C	COM2	Wiring diagram 1 - COM2			
		G-01DM (CN1)	RS-422	COM1	Wiring diagram 4 - COM1			
		G-01DM (CN2)		COM1	Wiring diagram 5 - COM1			
PZ3	Universal communication port	RS-232C	COM2	Wiring diagram 2 - COM2				
		RS-422	COM1	Wiring diagram 3 - COM1				
SR-T (K protocol)	SR-1T	Universal communication port	RS-485	COM1	Wiring diagram 6 - COM1			
SU/SG (K-Sequence)	SU-5E SU-6B	Programmer communication port	RS-232C	COM2	Wiring diagram 4 - COM2			
		Universal communication port	RS-232C	COM2	Wiring diagram 1 - COM2			
			RS-422	COM1	Wiring diagram 1 - COM1			
	SU-5M SU-6M	Programmer communication port	RS-232C	COM2	Wiring diagram 4 - COM2			
		Universal communication port 1	RS-232C	COM2	Wiring diagram 1 - COM2			
			RS-422	COM1	Wiring diagram 1 - COM1			
			RS-232C	COM2	Wiring diagram 3 - COM2			
	SZ-4	Universal communication port (PORT2)	RS-232C	COM2	Wiring diagram 3 - COM2			
						Programmer communication port (PORT1)		
	SZ-4M	Programmer communication port (PORT1)	RS-232C	COM2	Wiring diagram 3 - COM2			
		Universal communication port (PORT2)				RS-232C	COM2	Wiring diagram 2 - COM2
						RS-422	COM1	Wiring diagram 3 - COM1
	SU/SG (MODBUS RTU)	SU-5M SU-6M	Universal communication port 1	RS-232C	COM2	Wiring diagram 1 - COM2		
RS-422				COM1	Wiring diagram 1 - COM1			
Universal communication port 3			RS-422	COM1	Wiring diagram 2 - COM1			
SZ-4M		Universal communication port (PORT2)	RS-232C	COM2	Wiring diagram 2 - COM2			
			RS-422	COM1	Wiring diagram 3 - COM1			

*1 For the ladder transfer function, see "Appendix 5 Ladder Transfer Function".

24.1.1 SU/SG

Communication Setting

Editor

Communication setting

(Underlined setting: default)

Item	Setting	Remarks
Connection Mode	<u>1:1</u> / 1:n / Multi-link2 / Multi-link2 (Ethernet)	
Signal Level	<u>RS-232C</u> / RS-422/485	
Baud Rate	4800 / 9600 / <u>19200</u> / 38400 bps	
Data Length	8 bits	
Stop Bit	<u>1</u> / 2 bits	
Parity	None / <u>Odd</u> / Even	
Target Port No.	1 to 90	

SU-5

Host Link Module (U-01DM)

Online/offline selector switch (SW1)

SW1	Setting
	Online

Rotary switch (SW2, SW3)

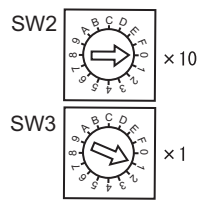
SW2, SW3	Item	Setting	Remarks
	Station number	01 to 5A (HEX)	

DIP switch (SW4)

(Underlined setting: default)

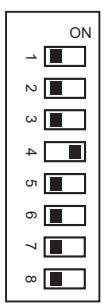
SW4	Item	Setting	Remarks																				
	No. 1 No. 2 No. 3	Baud rate	<table border="1"> <thead> <tr> <th></th> <th>No. 1</th> <th>No. 2</th> <th>No. 3</th> </tr> </thead> <tbody> <tr> <td>4800 bps</td> <td>ON</td> <td>OFF</td> <td>ON</td> </tr> <tr> <td>9600 bps</td> <td>OFF</td> <td>ON</td> <td>ON</td> </tr> <tr> <td>19200 bps</td> <td>ON</td> <td>ON</td> <td>ON</td> </tr> <tr> <td><u>38400 bps</u></td> <td>OFF</td> <td>OFF</td> <td>OFF</td> </tr> </tbody> </table>		No. 1	No. 2	No. 3	4800 bps	ON	OFF	ON	9600 bps	OFF	ON	ON	19200 bps	ON	ON	ON	<u>38400 bps</u>	OFF	OFF	OFF
		No. 1	No. 2	No. 3																			
	4800 bps	ON	OFF	ON																			
	9600 bps	OFF	ON	ON																			
19200 bps	ON	ON	ON																				
<u>38400 bps</u>	OFF	OFF	OFF																				
No. 4	Parity	OFF: <u>No parity</u> ON: Odd parity																					
No. 5	Self diagnosis	OFF: Not provided																					
No. 6 No. 7 No. 8	Response delay time	OFF: 0 ms																					

DIP switch (SW5)

(Underlined setting: default)

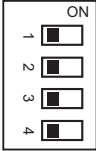
SW5	Item	Setting	Remarks
	No. 1	P-P setting	<u>OFF</u>
	No. 2	Master/slave setting	<u>OFF: Slave</u>
	No. 3	Time-out selection	<u>OFF: Normal operation</u>
	No. 4	ASCII/HEX selection	<u>OFF: HEX</u>

SU-5E/6B**Universal Communication Port****System parameter setting**

Set the station number, parity and data type using the system parameter setting of the programmer. For more information, refer to the PLC manual issued by the manufacturer.

(Underlined setting: default)

Item	Setting	Remarks
Parity	<u>Odd</u> / None	
Station number	<u>1</u> to 90	Valid only when DIP switch No. 2 is set to OFF
Data type	<u>HEX</u>	

The following settings are fixed; data length: 8 bits, and stop bit: 1 bit.

DIP switch

The DIP switch provided at the rear of the CPU is used to make the following settings.

(Underlined setting: default)

Switch	Item	Setting	Remarks									
	No. 1	Battery mode	<u>OFF: Without battery</u> ON: With battery									
	No. 2	Station number setting	<u>OFF: According to the system parameter setting</u> ON: Fixed to 01									
	No. 3	Baud rate	<table border="1"> <thead> <tr> <th>Baud Rate</th> <th>SW3</th> <th>SW4</th> </tr> </thead> <tbody> <tr> <td>9600 bps</td> <td>ON</td> <td>OFF</td> </tr> <tr> <td>19200 bps</td> <td>ON</td> <td>ON</td> </tr> </tbody> </table>	Baud Rate	SW3	SW4	9600 bps	ON	OFF	19200 bps	ON	ON
	Baud Rate			SW3	SW4							
9600 bps	ON	OFF										
19200 bps	ON	ON										
No. 4												

Host Link Module (U-01DM)

Settings are the same as those described in "SU-5" (page 24-2).

SU-5M/6M

Universal Communication Port 1

Set special registers "R772" and "R773", then specify "AA5A" (HEX) for the setting completion register "R767". When the set value at R767 is changed to "AAAA" (HEX), it is regarded as normal; if it is changed to "AAEA" (HEX), it is regarded as erroneous.

Parameter setting register

(Underlined setting: default)

Register	Setting	Setting Example
R772	<p>0 0 E 0</p> <p>Communication protocol 40: CCM E0: Automatic recognition (Modbus, CCM, K-Sequence)</p> <p>Communication timeout 0: 800 ms</p> <p>Response delay time 0: 0 ms</p>	00E0H CCM
R773	<p>8 7 0 1</p> <p>Station number 01 to 5A (HEX)</p> <p>Baud rate 4: 4800 bps 5: <u>9600 bps</u> 6: 19200 bps 7: 38400 bps</p> <p>Parity stop bit 0: Without parity, stop bit 1 2: Without parity, stop bit 2 8: <u>Odd parity, stop bit 1</u> A: Odd parity, stop bit 2 C: Even parity, stop bit 1 E: Even parity, stop bit 2</p>	8701H 38400 bps Odd parity Stop bit 1 Station number 01

Communication parameter settings can also be made by using the system parameter setting of the programmer. For more information, refer to the PLC manual issued by the manufacturer.

Universal Communication Port 2

Set special registers "R774" and "R775", then specify "A5AA" (HEX) for the setting completion register "R767". When the set value at R767 is changed to "AAAA" (HEX), it is regarded as normal; if it is changed to "AEAA" (HEX), it is regarded as erroneous.

Parameter setting register

Register	Setting	Setting Example
R774	Same as the setting register R772 for the universal port 1	00E0H
R775	Same as the setting register R773 for the universal port 1	8701H

Communication parameter settings can also be made by using the system parameter setting of the programmer. For more information, refer to the PLC manual issued by the manufacturer.

Universal Communication Port 3

Set special registers "R776" and "R777", then specify "5AAA" (HEX) for the setting completion register "R767". When the set value at R767 is changed to "AAAA" (HEX), it is regarded as normal; if it is changed to "EAAA" (HEX), it is regarded as erroneous.

Parameter setting register

Register	Setting	Setting Example
R776	Same as the setting register R772 for the universal port 1	00E0H
R777	Same as the setting register R773 for the universal port 1	8701H

Communication parameter settings can also be made by using the system parameter setting of the programmer. For more information, refer to the PLC manual issued by the manufacturer.

Host Link Module (U-01DM)

Settings are the same as those described in “SU-5” (page 24-2).

SU-6H

Universal Communication Port

Set special registers “R772” and “R773”, then specify “AA5A” (HEX) for the setting completion register “R767”. When the set value at R767 is changed to “AAAA” (HEX), it is regarded as normal; if it is changed to “AAEA” (HEX), it is regarded as erroneous.

Parameter setting register

(Underlined setting: default)

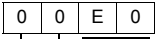
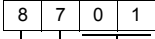
Register	Setting	Setting Example
R772	 <p>Communication protocol 40: CCM <u>E0</u>: Automatic recognition (Modbus, CCM, K-Sequence)</p> <p>Communication timeout 0: 800 ms</p> <p>Response delay time 0: 0 ms</p>	00E0H CCM
R773	 <p>Station number * <u>01</u> to 5A (HEX)</p> <p>Baud rate 4: 4800 bps <u>5: 9600 bps</u> 6: 19200 bps 7: 38400 bps</p> <p>Parity stop bit 0: Without parity, stop bit 1 2: Without parity, stop bit 2 <u>8: Odd parity, stop bit 1</u> A: Odd parity, stop bit 2 C: Even parity, stop bit 1 E: Even parity, stop bit 2</p>	8701H 38400 bps Odd parity Stop bit 1 Station number 01

* Valid only when DIP switch No. 2 is set to OFF

DIP switch

The DIP switch provided at the rear of the CPU is used to make the following settings.

(Underlined setting: default)

Switch	Item	Setting	Remarks
	No. 1	Battery mode OFF: <u>Without battery</u> ON: With battery	
	No. 2	Station number setting OFF: <u>According to the parameter setting</u> ON: Fixed to 01	
	No. 3 No. 4	– –	Invalid

Communication parameter settings can also be made by using the system parameter setting of the programmer. For more information, refer to the PLC manual issued by the manufacturer.

Host Link Module (U-01DM)

Settings are the same as those described in “SU-5” (page 24-2).

SZ-4

Universal Communication Port (PORT2)

System parameter setting

Set the station number, parity and data type using the system parameter setting of the programmer. For more information, refer to the PLC manual issued by the manufacturer.

(Underlined setting: default)

Item	Setting	Remarks
Parity	<u>Odd</u> / None	
Station number	<u>1</u> to 90	
Data type	HEX	

The following settings are fixed; data length: 8 bits, and stop bit: 1 bit.

Parameter setting register

Set the baud rate at special register "R7632".

(Underlined setting: default)

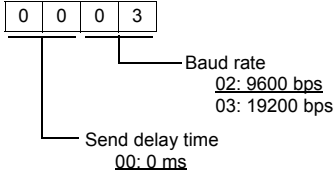
Register	Setting	Setting Example
R7632		<p>0003H</p> <p>19200 bps</p>

SZ-4M

Universal Communication Port (PORT2)

Set special registers "R7655" and "R7656", then specify "0500" (HEX) for the setting completion register "R7657". When the set value at R7657 is changed to "0A00" (HEX), it is regarded as normal; if it is changed to "0E00" (HEX), it is regarded as erroneous.

Parameter setting register

(Underlined setting: default)

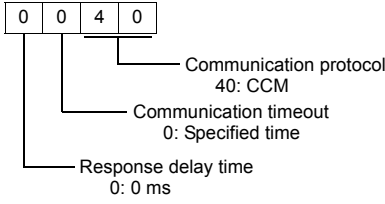
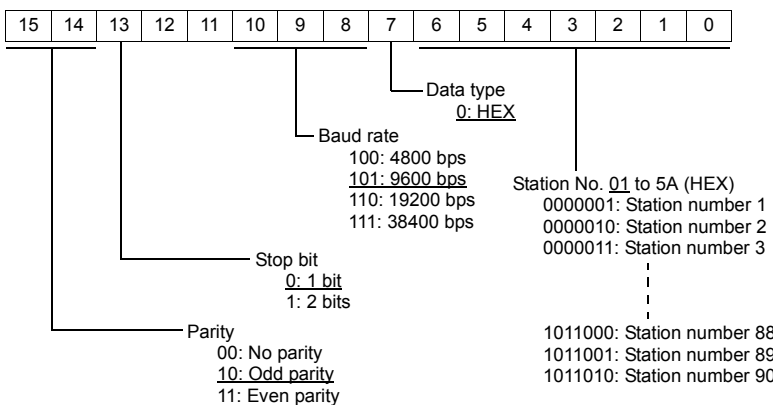
Register	Setting	Setting Example
R7655		<p>0040H</p> <p>CCM</p>
R7656		<p>8701H</p> <p>38400 bps</p> <p>Odd parity</p> <p>Stop bit 1</p> <p>Station number 01 HEX denotation</p> <p>1011000: Station number 88</p> <p>1011001: Station number 89</p> <p>1011010: Station number 90</p>

SG-8

Universal Communication Port

System parameter setting

Set the station number using the system parameter setting of the programmer. For more information, refer to the PLC manual issued by the manufacturer.

(Underlined setting: default)

Item	Setting	Remarks
Station number	<u>1</u> to 90	Valid only when DIP switch No. 2 is set to OFF
Data type	HEX	

The following settings are fixed; data length: 8 bits, parity: odd, and stop bit: 1 bit.

DIP switch

The DIP switch provided at the rear of the CPU is used to make the following settings.

(Underlined setting: default)

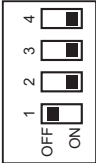
Switch	Item	Setting	Remarks									
	No. 1	Signal level OFF: <u>RS-422</u> ON: RS-232C										
	No. 2	Station number setting OFF: <u>According to the system parameter setting</u> ON: Fixed to 01										
	No. 3	Baud rate	<table border="1"> <thead> <tr> <th></th> <th>SW3</th> <th>SW4</th> </tr> </thead> <tbody> <tr> <td>9600 bps</td> <td>ON</td> <td>OFF</td> </tr> <tr> <td>19200 bps</td> <td>ON</td> <td>ON</td> </tr> </tbody> </table>		SW3	SW4	9600 bps	ON	OFF	19200 bps	ON	ON
				SW3	SW4							
9600 bps	ON	OFF										
19200 bps	ON	ON										
No. 4												

Host Link Module (G-01DM)

Online/offline selector switch

Selector Switch	Setting
	Online

DIP switch (SW1)

(Underlined setting: default)

SW1	Item	Setting	Remarks																																																															
	No. 1 No. 2 No. 3 No. 4 No. 5 No. 6 No. 7	Station number setting 1 to 90	For more information on any station number settings other than those given on the left, refer to the PLC manual issued by the manufacturer.																																																															
	No. 8	P-P setting OFF																																																																
	No. 9	Master/slave setting OFF: Slave																																																																
		<table border="1"> <thead> <tr> <th></th> <th>1</th> <th>2</th> <th>3</th> <th>4</th> <th>5</th> <th>6</th> <th>7</th> </tr> </thead> <tbody> <tr> <td>1</td> <td>ON</td> <td>OFF</td> <td>OFF</td> <td>OFF</td> <td>OFF</td> <td>OFF</td> <td>OFF</td> </tr> <tr> <td>2</td> <td>OFF</td> <td>ON</td> <td>OFF</td> <td>OFF</td> <td>OFF</td> <td>OFF</td> <td>OFF</td> </tr> <tr> <td>3</td> <td>ON</td> <td>ON</td> <td>OFF</td> <td>OFF</td> <td>OFF</td> <td>OFF</td> <td>OFF</td> </tr> <tr> <td>:</td> <td>:</td> <td>:</td> <td>:</td> <td>:</td> <td>:</td> <td>:</td> <td>:</td> </tr> <tr> <td>88</td> <td>OFF</td> <td>OFF</td> <td>OFF</td> <td>ON</td> <td>ON</td> <td>OFF</td> <td>ON</td> </tr> <tr> <td>89</td> <td>ON</td> <td>OFF</td> <td>OFF</td> <td>ON</td> <td>ON</td> <td>OFF</td> <td>ON</td> </tr> <tr> <td>90</td> <td>OFF</td> <td>ON</td> <td>OFF</td> <td>ON</td> <td>ON</td> <td>OFF</td> <td>ON</td> </tr> </tbody> </table>		1	2	3	4	5	6	7	1	ON	OFF	OFF	OFF	OFF	OFF	OFF	2	OFF	ON	OFF	OFF	OFF	OFF	OFF	3	ON	ON	OFF	OFF	OFF	OFF	OFF	:	:	:	:	:	:	:	:	88	OFF	OFF	OFF	ON	ON	OFF	ON	89	ON	OFF	OFF	ON	ON	OFF	ON	90	OFF	ON	OFF	ON	ON	OFF	ON
	1	2	3	4	5	6	7																																																											
1	ON	OFF	OFF	OFF	OFF	OFF	OFF																																																											
2	OFF	ON	OFF	OFF	OFF	OFF	OFF																																																											
3	ON	ON	OFF	OFF	OFF	OFF	OFF																																																											
:	:	:	:	:	:	:	:																																																											
88	OFF	OFF	OFF	ON	ON	OFF	ON																																																											
89	ON	OFF	OFF	ON	ON	OFF	ON																																																											
90	OFF	ON	OFF	ON	ON	OFF	ON																																																											

DIP switch (SW2)

(Underlined setting: default)

SW2	Item	Setting	Remarks																	
	No. 1 No. 2 No. 3	Baud rate	<table border="1"> <thead> <tr> <th></th> <th>SW1</th> <th>SW2</th> <th>SW3</th> </tr> </thead> <tbody> <tr> <td>4800 bps</td> <td>ON</td> <td>OFF</td> <td>ON</td> </tr> <tr> <td>9600 bps</td> <td>OFF</td> <td>ON</td> <td>ON</td> </tr> <tr> <td>19200 bps</td> <td>ON</td> <td>ON</td> <td>ON</td> </tr> </tbody> </table>		SW1	SW2	SW3	4800 bps	ON	OFF	ON	9600 bps	OFF	ON	ON	19200 bps	ON	ON	ON	
		SW1	SW2	SW3																
	4800 bps	ON	OFF	ON																
	9600 bps	OFF	ON	ON																
	19200 bps	ON	ON	ON																
	No. 4	Parity	<u>OFF</u> : No parity ON: Odd parity																	
	No. 5	Self diagnosis	<u>OFF</u> : Not provided																	
	No. 6	Turnaround delay	<u>OFF</u> : Not provided																	
	No. 7 No. 8	Response delay time	<u>OFF</u> : 0 ms																	
No. 9	ASCII/HEX selection	<u>OFF</u> : HEX																		

Short plug 1

Short plug 1 is used to short-circuit the FG (frame ground) and 0-V power for the communication system.

Plug	Setting	Remarks
	G side: Not short-circuited FG side: Short-circuited	

Short plug 2

Short plug 2 is used to switch the signal level of the CH2 port.

Plug	Setting	Remarks
	RS-232C ENABLE: RS-232C RS-232C DISABLE: RS-422	

PZ3

Universal Communication Port

Settings are the same as those described in "SZ-4" (page 24-6).

Available Memory

The available memory setting range varies depending on the PLC model. Be sure to set within the range available for the PLC. Use [TYPE] when assigning the indirect memory for macro programs.

Memory	TYPE	Remarks
R (data register)	00H	
I (input)	01H	
Q (output)	02H	
M (internal relay)	03H	
S (stage)	04H	
GI (link input)	05H	
GQ (link output)	06H	
T (timer/contact)	07H	
C (counter/contact)	08H	

24.1.2 SR-T (K Protocol)

Communication Setting

Editor

Communication setting

(Underlined setting: default)

Item	Setting	Remarks
Connection Mode	<u>1:1</u> / Multi-link2 / Multi-link2 (Ethernet)	
Signal Level	<u>RS-422/485</u>	
Baud Rate	<u>19200</u>	
Data Length	<u>8 bits</u>	
Stop Bit	<u>1 bit</u>	
Parity	<u>Odd</u>	
Target Port No.	0 to 31	

PLC

Universal Communication Port

No particular setting is necessary on the PLC. The PLC always performs communication functions using the following parameters. Set the following parameters on the [Communication Setting] tab window of the editor.

Item	Setting	Remarks
Baud rate	<u>19200 bps</u>	
Parity	<u>Odd</u>	
Data length	<u>8 bits</u>	
Stop bit	<u>1 bit</u>	
Data type	<u>HEX</u>	

Calendar

This model is not equipped with the calendar function. Use the built-in clock of the TS series.

Available Memory

The available memory setting range varies depending on the PLC model. Be sure to set within the range available for the PLC. Use [TYPE] when assigning the indirect memory for macro programs.

Memory	TYPE	Remarks
D (word device)	00H	
X (input)	01H	Common to X and Y
Y (output)	02H	Common to X and Y
M (internal relay)	03H	
S (stage)	04H	
K (keep relay)	05H	
L (link relay)	06H	
T (timer/contact)	07H	
C (counter/contact)	08H	

24.1.3 SU/SG (K-Sequence)

Communication Setting

Editor

Communication setting

(Underlined setting: default)

Item	Setting	Remarks
Connection Mode	<u>1:1</u> / Multi-link2	
Signal Level	<u>RS-232C</u> / RS-422/485	
Baud Rate	4800 / 9600 / <u>19200</u> / 38400 bps	
Data Length	8 bits	
Stop Bit	<u>1</u> / 2 bits	
Parity	None / <u>Odd</u> / Even	
Target Port No.	0 to 31	

SU-5M/6M

Programmer Communication Port

No particular setting is necessary on the PLC. The PLC always performs communication functions using the following parameters. Set the following parameters on the [Communication Setting] tab window of the editor.

Item	Setting	Remarks
Baud Rate	9600 bps	
Parity	Odd	
Data Length	8	
Stop Bit	1	
Data Type	HEX	

Universal Communication Port 1

Set parameters into the special register "R772, 773", then set "AA5A" (HEX) into the setting complete register "R767". When the set value at R767 is changed to "AAAA" (HEX), it is regarded as normal; if it is changed to "AAEA" (HEX), it is regarded as erroneous.

Parameter setting register

(Underlined setting: default)

Register	Setting	Setting Example
R772	<p>0 0 E 0</p> <p>Communication protocol 80: K-Sequence <u>E0</u>: Automatic recognition (Modbus, CCM, K-Sequence)</p> <p>Communication timeout 0: 800 ms</p> <p>Response delay time 0: 0 ms</p>	00E0H K-Sequence
R773	<p>8 7 0 1</p> <p>Station number 01 to 1F (HEX)</p> <p>Baud rate 4: 4800 bps 5: 9600 bps <u>6: 19200 bps</u> 7: 38400 bps</p> <p>Parity stop bit 0: Without parity, stop bit 1 2: Without parity, stop bit 2 <u>8: Odd parity, stop bit 1</u> A: Odd parity, stop bit 2 C: Even parity, stop bit 1 E: Even parity, stop bit 2</p>	8701H 38400 bps Odd parity Stop bit 1 Station number 01

Communication parameter settings can also be made by using the system parameter setting of the programmer. For more information, refer to the PLC manual issued by the manufacturer.

Universal Communication Port 2

Set parameters into the special register "R774, 775", then set "A5AA" (HEX) into the setting complete register "R767". When the set value at R767 is changed to "AAAA" (HEX), it is regarded as normal; if it is changed to "AEAA" (HEX), it is regarded as erroneous.

Parameter setting register

Register	Setting	Setting Example
R774	Same as the setting register R772 for the universal port 1	00E0H
R775	Same as the setting register R773 for the universal port 1	8701H

Communication parameter settings can also be made by using the system parameter setting of the programmer. For more information, refer to the PLC manual issued by the manufacturer.

Universal Communication Port 3

Set parameters into the special register "R776, 777", then set "5AAA" (HEX) into the setting complete register "R767". When the set value at R767 is changed to "AAAA" (HEX), it is regarded as normal; if it is changed to "EAAA" (HEX), it is regarded as erroneous.

Parameter setting register

Register	Setting	Setting Example
R776	Same as the setting register R772 for the universal port 1	00E0H
R777	Same as the setting register R773 for the universal port 1	8701H

Communication parameter settings can also be made by using the system parameter setting of the programmer. For more information, refer to the PLC manual issued by the manufacturer.

SZ-4/SZ-4M**Programmer Communication Port (PORT1) / Universal Communication Port (PORT2)**

No particular setting is necessary on the PLC. The PLC performs communication functions using the following parameters. Set the following parameters on the [Communication Setting] tab window of TS.

Item	Setting	Remarks
Baud Rate	9600 bps	For PORT2: 19200 bps can be set in the special register.
Parity	Odd	
Data Length	8	
Stop Bit	1	
Data Type	HEX	

Available Memory

The available memory setting range varies depending on the PLC model. Be sure to set within the range available for the PLC. Use [TYPE] when assigning the indirect memory for macro programs.

Memory	TYPE	Remarks
R (data register)	00H	
I (input)	01H	
Q (output)	02H	
M (internal relay)	03H	
S (stage)	04H	
GI (link input)	05H	
GQ (link output)	06H	
T (timer/contact)	07H	
C (counter/contact)	08H	

24.1.4 SU/SG (MODBUS RTU)

Communication Setting

Editor

Communication setting

(Underlined setting: default)

Item	Setting	Remarks
Connection Mode	<u>1</u> : 1 / 1 : n / Multi-link2	
Signal Level	<u>RS-232C</u> / RS-422/485	
Baud Rate	4800 / 9600 / <u>19200</u> / 38400 bps	
Data Length	8 bits	
Stop Bit	<u>1</u> / 2 bits	
Parity	None / <u>Odd</u> / Even	
Target Port No.	0 to 90	

SU-5M/6M

Universal Communication Port 1

Set parameters into the special register "R772, 773", then set "AA5A" (HEX) into the setting complete register "R767". When the set value at R767 is changed to "AAAA" (HEX), it is regarded as normal; if it is changed to "AAEA" (HEX), it is regarded as erroneous.

Parameter setting register

(Underlined setting: default)

Register	Setting	Setting Example
R772	<p>0 0 <u>E</u> 0</p> <p>Communication protocol 20: MODBUS RTU <u>E0</u>: Automatic recognition (Modbus, CCM, K-Sequence)</p> <p>Communication timeout 0: 800 ms</p> <p>Response delay time 0: 0 ms</p>	00E0H
R773	<p>8 6 0 1</p> <p>Station number 01 to 5A (HEX)</p> <p>Baud rate 4: 4800 bps 5: 9600 bps <u>6</u>: 19200 bps 7: 38400 bps</p> <p>Parity stop bit 0: Without parity, stop bit 1 2: Without parity, stop bit 2 <u>8</u>: Odd parity, stop bit 1 A: Odd parity, stop bit 2 C: Even parity, stop bit 1 E: Even parity, stop bit 2</p>	8701H 38400 bps Odd parity Stop bit 1 Station number 01

Communication parameter settings can also be made by using the system parameter setting of the programmer. For more information, refer to the PLC manual issued by the manufacturer.

Universal Communication Port 3

Set parameters into the special register "R776, 777", then set "5AAA" (HEX) into the setting complete register "R767". When the set value at R767 is changed to "AAAA" (HEX), it is regarded as normal; if it is changed to "EAAA" (HEX), it is regarded as erroneous.

Parameter setting register

Register	Setting	Setting Example
R776	Same as the setting register R772 for the universal port 1	00E0H
R777	Same as the setting register R773 for the universal port 1	8701H

Communication parameter settings can also be made by using the system parameter setting of the programmer. For more information, refer to the PLC manual issued by the manufacturer.

SZ-4M

Universal Communication Port (PORT2)

Set parameters into the special register "R7655, 7656", then set "0500" (HEX) into the setting complete register "R7657". When the set value at R7657 is changed to "0A00" (HEX), it is regarded as normal; if it is changed to "0E00" (HEX), it is regarded as erroneous.

Parameter setting register

(Underlined setting: default)

Register	Setting	Setting Example
R7655		0020H
R7656		8701H 38400 bps Odd parity Stop bit 1 Station number 01 HEX denotation

Communication parameter settings can also be made by using the system parameter setting of the programmer. For more information, refer to the PLC manual issued by the manufacturer.

Available Memory

The available memory setting range varies depending on the PLC model. Be sure to set within the range available for the PLC. Use [TYPE] when assigning the indirect memory for macro programs.

Memory	TYPE	Remarks
R (data register)	00H	
I (input)	01H	
Q (output)	02H	
M (internal relay)	03H	
S (stage)	04H	
GI (link input)	05H	
GQ (link output)	06H	
T (timer/contact)	07H	
C (counter/contact)	08H	

24.1.5 Wiring Diagrams

When Connected at COM1:

RS-422/RS-485

Wiring diagram 1 - COM1

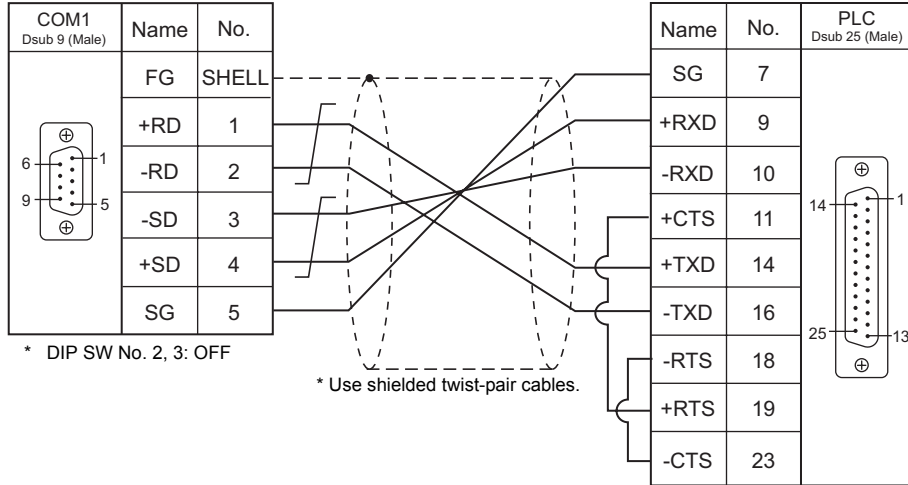

Wiring diagram 2 - COM1

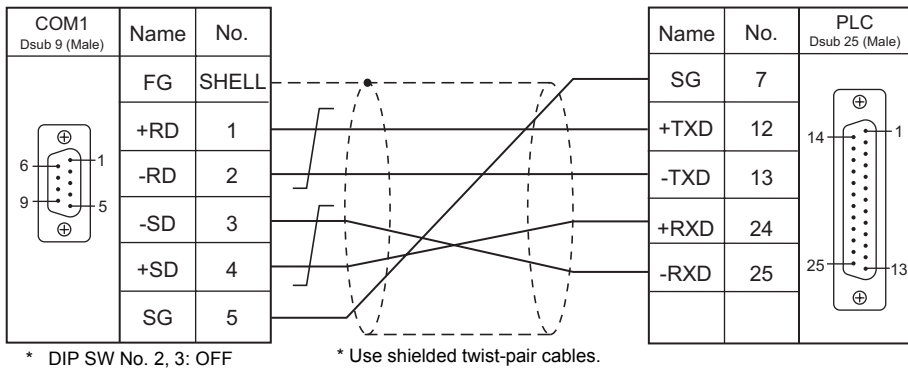

* SU-6M: Terminal block connectable

Wiring diagram 3 - COM1

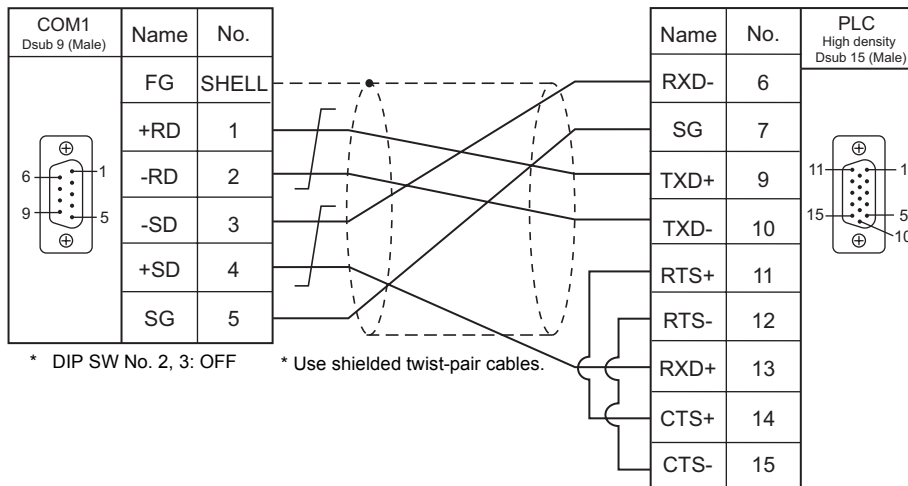

Wiring diagram 4 - COM1

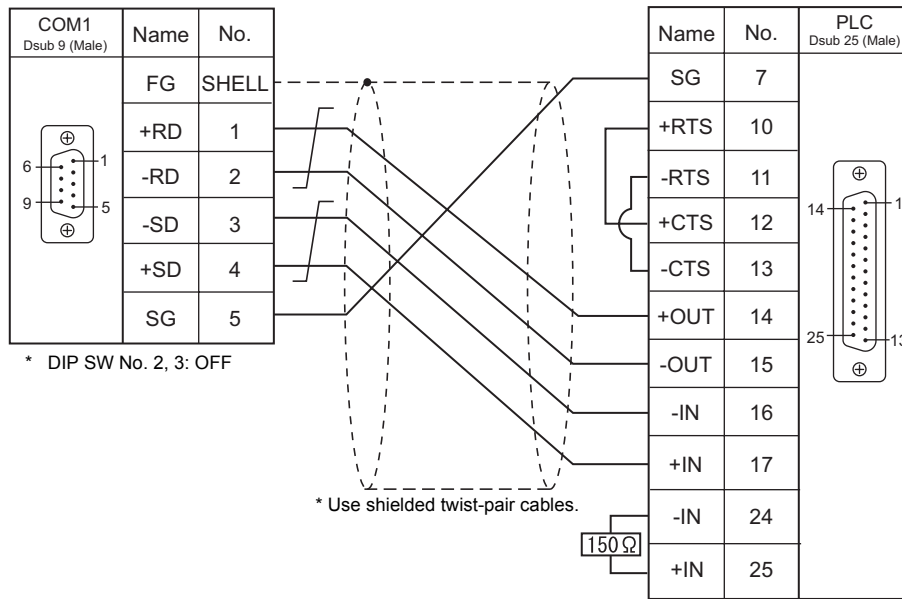

Wiring diagram 5 - COM1

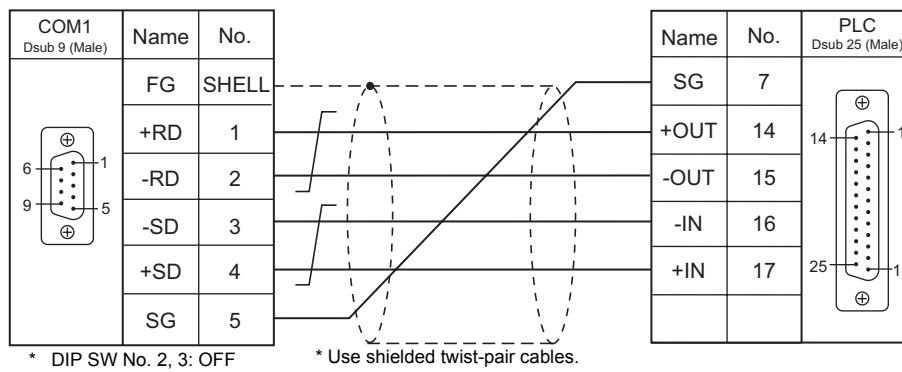

Wiring diagram 6 - COM1

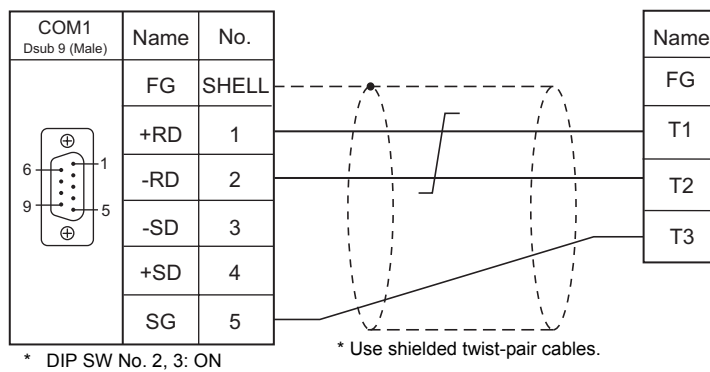

When Connected at COM2:

RS-232C

Wiring diagram 1 - COM2

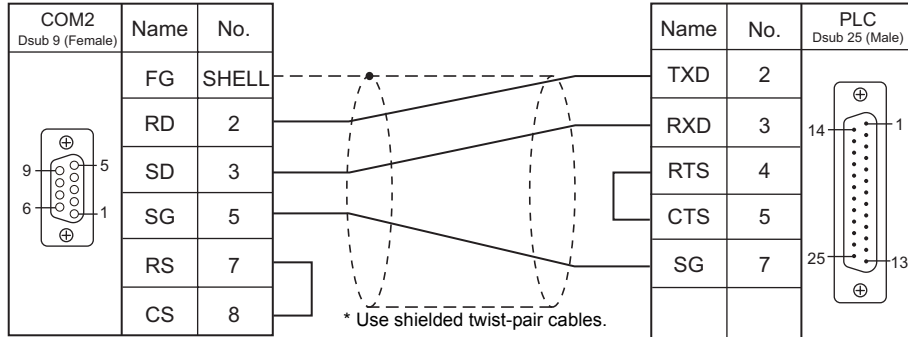

Wiring diagram 2 - COM2

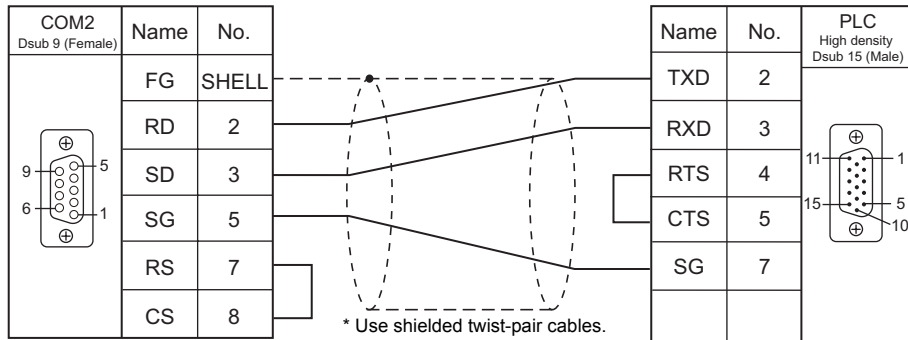

Wiring diagram 3 - COM2

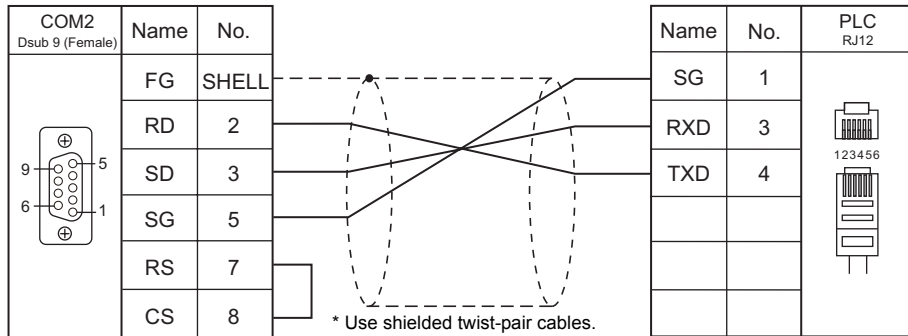

Wiring diagram 4 - COM2

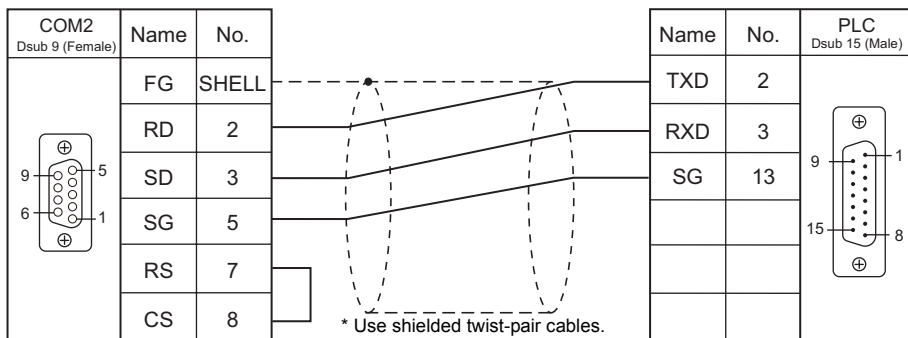

When Connected at COM3:

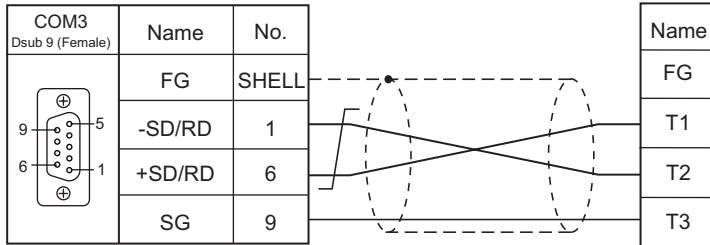
RS-485**Wiring diagram 1 - COM3**

* Use shielded twist-pair cables.

MEMO

Please use this page freely.

25. LS

25.1 PLC Connection

25.1 PLC Connection

Serial Connection

PLC Selection on the Editor	CPU		Unit/Port	Signal Level	TS Port	Connection	Ladder Transfer ^{*1}
MASTER-KxxxS	K200S	K3P-07AS	RS-232C port on the CPU unit	RS-232C	COM2	Wiring diagram 1 - COM2	
		K3P-07CS					
	K300S	K4P-15AS					
	K1000S	K7P-30AS					
MASTER-KxxxS CNET	K200S	K3P-07AS K3P-07BS K3P-07CS	K3F-CU2A	RS-232C	COM2	Wiring diagram 2 - COM2	
			K3F-CU4A	RS-422	COM1	Wiring diagram 1 - COM1	
				RS-485	COM3	Wiring diagram 1 - COM3	
	K300S	K4P-15AS	K4F-CUEA	RS-232C	COM2	Wiring diagram 2 - COM2	
				RS-422	COM1	Wiring diagram 1 - COM1	
				RS-485	COM3	Wiring diagram 1 - COM3	
	K1000S	K7P-30AS	K7F-CUEA	RS-232C	COM2	Wiring diagram 2 - COM2	
				RS-422	COM1	Wiring diagram 1 - COM1	
				RS-485	COM3	Wiring diagram 1 - COM3	
				RS-232C	COM2	Wiring diagram 2 - COM2	
GLOFA CNET	GM6	GM6-CPUA GM6-CPUB GM6-CPUC	G6L-CUEB	RS-232C	COM2	Wiring diagram 2 - COM2	
			G6L-CUEC	RS-422	COM1	Wiring diagram 1 - COM1	
	GM4	GM4-CPUA		G4L-CUEA	RS-485	COM3	
			RS-232C		COM2	Wiring diagram 2 - COM2	
			RS-422		COM1	Wiring diagram 1 - COM1	
	GM3	GM3-CPUA	G3L-CUEA	RS-485	COM3	Wiring diagram 1 - COM3	
				RS-232C	COM2	Wiring diagram 2 - COM2	
				RS-422	COM1	Wiring diagram 1 - COM1	
	GLOFA GM7 CNET	GM7	G7M-DR G7M-DT	G7L-CUEB	RS-232C	COM2	
G7L-CUEC				RS-422	COM1	Wiring diagram 1 - COM1	
				RS-485	COM3	Wiring diagram 1 - COM3	
GLOFA GM series CPU	GM6	GM6-CPUA GM6-CPUB GM6-CPUC	RS-232C port on the CPU unit	RS-232C	COM2	Wiring diagram 1 - COM2	
	GM4	GM4-CPUA					
	GM3	GM3-CPUA					
	GM7	G7M-DR G7M-DT					
XGT/XGK series CNET	XGK-CPUH XGK-CPUA XGK-CPUS XGK-CPUE		XGL-C22A	RS-232C	COM2	Wiring diagram 1 - COM2	
			XGL-CH2A	RS-232C			
				RS-422	COM1	Wiring diagram 2 - COM1	
				RS-485	COM3	Wiring diagram 2 - COM3	
			XGL-C42A	RS-422	COM1	Wiring diagram 2 - COM1	
RS-485	COM3	Wiring diagram 2 - COM3					
XGT/XGK series CPU	XGK-CPUH XGK-CPUA XGK-CPUS XGK-CPUE		RS-232C port on the CPU unit	RS-232C	COM2	Wiring diagram 1 - COM2	
XGT/XGI series CNET	XGI-CPUH XGI-CPUU XGI-CPUS		XGL-C22A	RS-232C	COM2	Wiring diagram 1 - COM2	
			XGL-CH2A	RS-232C			
				RS-422	COM1	Wiring diagram 2 - COM1	
				RS-485	COM3	Wiring diagram 2 - COM3	
			XGL-C42A	RS-422	COM1	Wiring diagram 2 - COM1	
RS-485	COM3	Wiring diagram 2 - COM3					
XGT/XGI series CPU	XGI-CPUH XGI-CPUU XGI-CPUS		RS-232C port on the CPU unit	RS-232C	COM2	Wiring diagram 1 - COM2	

×

Ethernet Connection

PLC Selection on the Editor	CPU	Unit	TCP/IP	UDP/IP	Port No.	Ladder Transfer ^{*1}
GLOFA GM series (Ethernet UDP/IP)	GM6	G6L-EUTB	×	○	2005 fixed	×
XGT/XGK series (Ethernet)	XGK-CPUH XGK-CPUA XGK-CPUS XGK-CPUE XGK-CPUU	XGL-EFMT	○	○	TCP/IP: 2004 fixed (Max. 16 units)	
					UDP/IP: 2005 fixed	
XGT/XGI series (Ethernet)	XGI-CPUH XGI-CPUU XGI-CPUS	XGL-EFMT	○	○	TCP/IP: 2004 fixed (Max. 16 units)	
					UDP/IP: 2005 fixed	

25.1.1 MASTER-KxxxS

Communication Setting

Editor

Communication setting

(Underlined setting: default)

Item	Setting	Remarks
Connection Mode	<u>1:1</u> / Multi-link2	
Signal Level	<u>RS-232C</u>	
Baud Rate	9600 / 19200 / <u>38400</u> / 57600 / 76800 / 115200 bps	
Data Length	<u>8 bits</u>	
Stop Bit	<u>1 bit</u>	
Parity	<u>None</u>	

PLC

No particular setting is necessary on the PLC.

Calendar

Although this model is equipped with the calendar function, the TS series cannot read and write to the calendar. Use the built-in clock of the TS series.

Available Memory

The available memory setting range varies depending on the PLC model. Be sure to set within the range available for the PLC. Use [TYPE] when assigning the indirect memory for macro programs.

Memory	TYPE	Remarks
P (input/output relay)	00H	Input relay: read only
M (auxiliary relay)	01H	
L (link relay)	02H	
K (keep relay)	03H	
F (special relay)	04H	Read only
T (timer/current value)	05H	
C (counter/current value)	06H	
D (data register)	07H	
TC (timer/contact)	09H	
CC (counter/contact)	0AH	

25.1.2 MASTER-KxxxS CNET

Communication Setting

Editor

Communication setting

(Underlined setting: default)

Item	Setting	Remarks
Connection Mode	<u>1</u> : 1 / 1 : n / Multi-link2	
Signal Level	<u>RS-232C</u> / RS-422/485	
Baud Rate	9600 / 19200 / <u>38400</u> / 57600 / 76800 / 115200 bps	
Data Length	7 / <u>8</u> bits	
Stop Bit	<u>1</u> / 2 bits	
Parity	<u>None</u> / Odd / Even	
Target Port No.	<u>0</u> to 31	

PLC

MODE switch

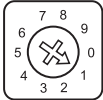
MODE Switch	Operation Mode	Remarks	
	K3F-CU2A K3F-CU4A	1: Dedicated	
	K4F-CUEA K7F-CUEA	RS-232C	3, 5: Dedicated
		RS-422	3, 4, 7: Dedicated
		Stand-alone mode	

KGL_WIN for Windows

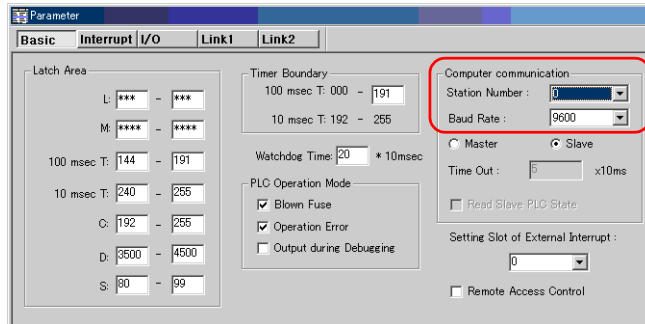

(Underlined setting: default)

Item	Setting	Remarks
Station Number	<u>0</u> to 31	
Baud Rate	9600 / 19200 / <u>38400</u> bps	

Cnet Frame Editor

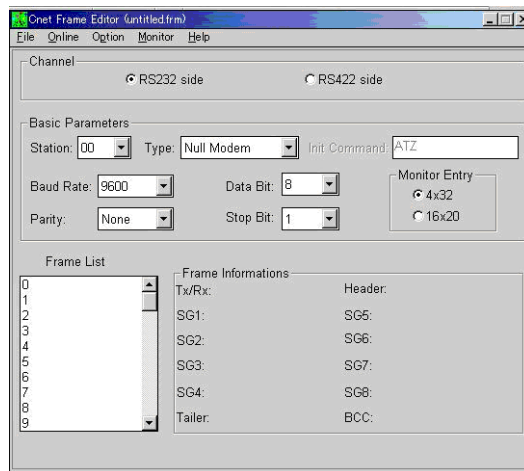

(Underlined setting: default)

Item	Setting	Remarks
Channel	<u>RS232C</u> / RS422	
Baud Rate	9600 / 19200 / <u>38400</u> / 76800 bps	76800: Valid only when [Channel: RS422 side] is selected
Data Bit	7 / <u>8</u> bits	
Stop Bit	<u>1</u> / 2 bits	
Parity	<u>None</u> / Odd / Even	
Station	<u>0</u> to 31	
Type	<u>RS422</u> / RS485	To be set only when [Channel: RS422 side] is selected

Available Memory

The available memory setting range varies depending on the PLC model. Be sure to set within the range available for the PLC. Use [TYPE] when assigning the indirect memory for macro programs.

Memory	TYPE	Remarks
P (input/output relay)	00H	PW as word device, input relay: read only
M (auxiliary relay)	01H	MW as word device
L (link relay)	02H	LW as word device
K (keep relay)	03H	KW as word device
F (special relay)	04H	FW as word device, read only
T (timer/current value)	05H	
C (counter/current value)	06H	
D (data register)	07H	
TC (timer/contact)	09H	
CC (counter/contact)	0AH	

25.1.3 GLOFA CNET

Communication Setting

Editor

Communication setting

(Underlined setting: default)

Item	Setting	Remarks
Connection Mode	<u>1</u> : 1 / 1 : n / Multi-link2 / Multi-link2 (Ethernet) / 1 : n Multi-link2 (Ethernet)	
Signal Level	<u>RS-232C</u> / RS-422/485	
Baud Rate	9600 / 19200 / <u>38400</u> / 57600 / 76800 bps	
Data Length	7 / <u>8</u> bits	
Stop Bit	<u>1</u> / 2 bits	
Parity	<u>None</u> / Odd / Even	
Target Port No.	<u>0</u> to 31	

PLC

Cnet Frame Editor

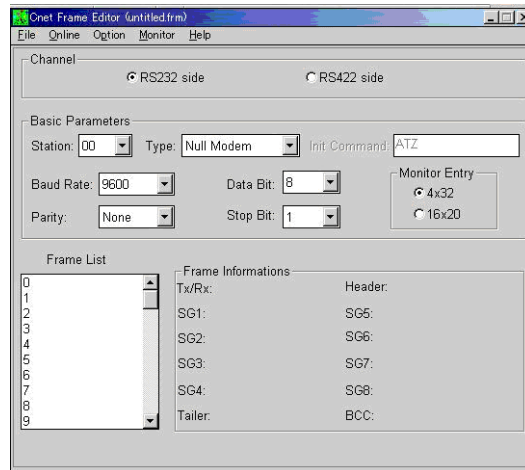

(Underlined setting: default)

Item	Setting	Remarks
Channel	<u>RS232C</u> / RS422	
Baud Rate	9600 / 19200 / <u>38400</u> / 76800 bps	76800: Valid only when [Channel: RS422 side] is selected
Data Bit	7 / <u>8</u> bits	
Stop Bit	<u>1</u> / 2 bits	
Parity	<u>None</u> / Odd / Even	
Station	<u>0</u> to 31	
Type	<u>RS422</u> / RS485	To be set only when [Channel: RS422 side] is selected

Calendar

This model is not equipped with the calendar function. Use the built-in clock of the TS series.

Available Memory

The available memory setting range varies depending on the PLC model. Be sure to set within the range available for the PLC. Use [TYPE] when assigning the indirect memory for macro programs.

Memory	TYPE	Remarks
M (internal memory)	00H	MW as word device
Q (output)	01H	QW as word device *1
I (input)	02H	IW as word device *1

*1 The assigned memory is indicated when editing the screen as shown on the right.

Example: Q 0 . 0 . 0

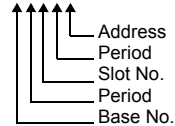

Indirect Memory Designation

	15	8	7	0
n+0	Model		Memory type	
n+1	Address No.			
n+2	Expansion code		Bit designation	
n+3	00		Station number	

- Using Q or I device

- Word access

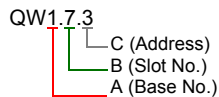

$$\text{Address number} = A \times 32 + B \times 4 + C = 1 \times 32 + 7 \times 4 + 3 = 63$$

Specify "63" (DEC) for the address number.

- Bit access

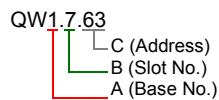

$$\begin{aligned} \text{Address number} &= A \times 32 + B \times 4 + (\text{quotient of } C \text{ divided by } 16) \\ &= 1 \times 32 + 7 \times 4 + (63 \div 16) = 63 \end{aligned}$$

$$\text{Bit designation} = \text{remainder when } C \text{ is divided by } 16 = (63 \div 16) = 15$$

Specify "63" (DEC) for the address number, and "15" (DEC) for the bit designation.

25.1.4 GLOFA GM7 CNET

Communication Setting

Editor

Communication setting

(Underlined setting: default)

Item	Setting	Remarks
Connection Mode	<u>1</u> : 1 / 1 : n / Multi-link2 / Multi-link2 (Ethernet) / 1 : n Multi-link2 (Ethernet)	
Signal Level	<u>RS-232C</u> / RS-422/485	
Baud Rate	4800 / 9600 / <u>19200</u> / 38400 / 57600 bps	
Data Length	7 / <u>8</u> bits	
Stop Bit	<u>1</u> / 2 bits	
Parity	<u>None</u> / Odd / Even	
Target Port No.	<u>0</u> to 31	

PLC

Mode switches

TM/TC MODE	Setting	Remarks
G7L-CUEB 	BUILT IN CNET	OFF
	ROM MODE	OFF/ON

* G7L-CUEC is not provided with mode switches.

Communication Channel 0

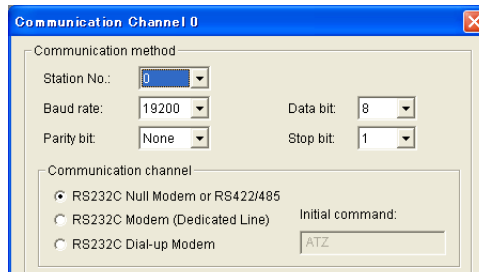

(Underlined setting: default)

Item	Setting	Remarks
Station No.	<u>0</u> to 31	
Baud rate	4800 / 9600 / <u>19200</u> / 38400 / 57600 bps	
Data bit	7 / <u>8</u> bits	
Parity bit	<u>None</u> / Odd / Even	
Stop bit	<u>1</u> / 2 bits	

Calendar

This model is not equipped with the calendar function. Use the built-in clock of the TS series.

Available Memory

The contents of "Available Memory" are the same as those described in "25.1.3 GLOFA CNET".

25.1.5 GLOFA GM Series CPU

Communication Setting

Editor

Communication setting

(Underlined setting: default)

Item	Setting	Remarks
Connection Mode	<u>1:1</u> / Multi-link2 / Multi-link2 (Ethernet)	
Signal Level	<u>RS-232C</u> / RS-422/485	
Baud Rate	<u>38400</u> bps	
Data Length	<u>8</u> bits	
Stop Bit	<u>1</u> bit	
Parity	<u>None</u>	
Target Port No.	Q to 31	

PLC

No particular setting is necessary on the PLC.

The following settings are fixed; baud rate: 38400 bps, data length: 8 bits, without parity, and stop bit: 1 bit.

Calendar

This model is not equipped with the calendar function. Use the built-in clock of the TS series.

Available Memory

The contents of "Available Memory" are the same as those described in "25.1.3 GLOFA CNET".

25.1.6 GLOFA GM Series (Ethernet UDP/IP)

Communication Setting

Editor

Make the following settings on the editor. For more information, see “Appendix 2 Ethernet”.

- IP address for the TS unit
 - When specified on the screen data:
[System Setting] → [Ethernet Communication] → [Local Port IP Address]
 - When specified on the TS unit
Main Menu screen → [Ethernet]
- Port number for the TS unit (for communication with PLC)
[System Setting] → [Device Connection Setting] → [Communication Setting]
- IP address and port number (No. 2005) for the PLC
[System Setting] → [Device Connection Setting] → [PLC Table]

PLC

Set the IP address using “Enet Editor”.

The port number is fixed to “2005”.

For more information, refer to the PLC manual issued by the manufacturer.

Calendar

This model is not equipped with the calendar function. Use the built-in clock of the TS series.

Available Memory

The contents of “Available Memory” are the same as those described in “25.1.3 GLOFA CNET”.

25.1.7 XGT/XGK Series CNET

Communication Setting

Editor

Communication setting

(Underlined setting: default)

Item	Setting	Remarks
Connection Mode	<u>1:1</u> / 1 : n / Multi-link2	
Signal Level	<u>RS-232C</u> / RS-422/485	
Baud Rate	4800 / <u>9600</u> / 19200 / 38400 /57600 / 115200 bps	
Data Length	7 / <u>8</u> bits	
Stop Bit	<u>1</u> / 2 bits	
Parity	<u>None</u> / Odd / Even	
Target Port No.	<u>0</u> to 31	

PLC

Set parameters using "XG_PD". For more information, refer to the PLC manual issued by the manufacturer.

Communication setting

(Underlined setting: default)

Item	Setting	Remarks
Type	<u>RS-232C</u> / RS-422	
Speed	4800 / <u>9600</u> / 19200 / 38400 /57600 / 115200 bps	
Data bit	7 / <u>8</u> bits	
Stop Bit	<u>1</u> / 2 bits	
Parity	<u>None</u> / Odd / Even	
Station	<u>0</u> to 31	

Calendar

This model is equipped with a calendar function; however, the calendar data cannot be written from the TS series. Thus, time correction must be performed on the PLC side.

Available Memory

The available memory setting range varies depending on the PLC model. Be sure to set within the range available for the PLC. Use [TYPE] when assigning the indirect memory for macro programs.

Memory	TYPE	Remarks
P (input/output relay)	00H	PW as word device, input relay: read only
M (auxiliary relay)	01H	MW as word device
L (link relay)	02H	LW as word device
K (keep relay)	03H	KW as word device
F (special relay)	04H	FW as word device; FW0 to FW1023: read only
T (timer/current value)	05H	
C (counter/current value)	06H	
D (data register)	07H	
TC (timer/contact)	09H	
CC (counter/contact)	0AH	
N (communication data register)	0BH	
R (file register)	0CH	RW as word device
ZR (file register)	0DH	
U (analog data register)	0EH	UW as word device *1

*1 The assigned memory is indicated when editing the screen as shown on the right.

Example: U 3 1 . 31 . F

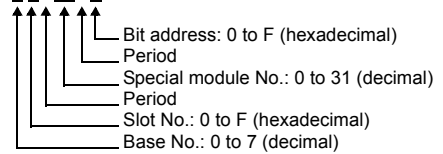

Indirect Memory Designation

	15	8	7	0
n+0	Model		Memory type	
n+1	Address No.			
n+2	Expansion code		Bit designation	
n+3	00		Station number	

Example: Indirect memory designation of "UW1F.31"

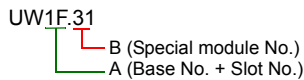

Address number = A converted to decimal × 32 + B = 1F (HEX) → 31 (DEC) × 32 + 31 = 1023

Specify "1023" (DEC) for the address number.

25.1.8 XGT/XGK Series CPU

Communication Setting

Editor

Communication setting

(Underlined setting: default)

Item	Setting	Remarks
Connection Mode	<u>1:1</u> / Multi-link2	
Signal Level	<u>RS-232C</u>	
Baud Rate	<u>115200</u> bps	
Data Length	<u>8</u> bits	
Stop Bit	<u>1</u> bit	
Parity	<u>None</u>	

PLC

No particular setting is necessary on the PLC.

The following settings are fixed; baud rate: 115200 bps, data length: 8 bits, without parity, and stop bit: 1 bit.

Available Memory

The contents of "Available Memory" are the same as those described in "25.1.7 XGT/XGK Series CNET".

25.1.9 XGT / XGK Series (Ethernet)

Communication Setting

Editor

Make the following settings on the editor. For more information, see Appendix 2 Ethernet.

- IP address for the TS unit
 - When specified on the screen data:
[System Setting] → [Ethernet Communication] → [Local Port IP Address]
 - When specified on the TS unit:
Main Menu screen → [Ethernet]
- Port number for the TS unit (for communication with PLC)
[System Setting] → [Device Connection Setting] → [Communication Setting]
- IP address and port number (No. 2004 for TCP/IP or No. 2005 for UDP/IP) for the PLC
[System Setting] → [Device Connection Setting] → [PLC Table]

PLC

Go to [Standard Settings] in XG-PD and set the IP address.

The port numbers are 2004 for TCP/IP and 2005 for UDP/IP (both fixed).

For more information, refer to the PLC manual issued by the manufacturer.

Calendar

Although this model is equipped with the calendar function, the TS series cannot read and write to the calendar. Use the built-in clock of the TS series.

Available Memory

The contents of "Available Memory" are the same as those described in "25.1.7 XGT/XGK Series CNET".

25.1.10 XGT / XGI Series CNET

Communication Setting

Editor

Communication setting

(Underlined setting: default)

Item	Setting	Remarks
Connection Mode	<u>1</u> : 1 / 1 : n / Multi-link2 / Multi-link2 (Ethernet) / 1 : n Multi-link2 (Ethernet)	
Signal Level	<u>RS-232C</u> / RS-422/485	
Baud Rate	4800 / <u>9600</u> / 19200 / 38400 /57600 / 115200 bps	
Data Length	7 / <u>8</u> bits	
Stop Bit	<u>1</u> / 2 bits	
Parity	<u>None</u> / Odd / Even	
Target Port No.	<u>0</u> to 31	

PLC

Set parameters in XG-PD. For more information, refer to the PLC manual issued by the manufacturer.

Communication settings

(Underlined setting: default)

Item	Setting	Remarks
Type	<u>RS-232C</u> / RS-422	
Speed	4800 / <u>9600</u> / 19200 / 38400 /57600 / 115200 bps	
Data bit	7 / <u>8</u> bits	
Stop Bit	<u>1</u> / 2 bits	
Parity bit	<u>None</u> / Odd / Even	
Station Number	<u>0</u> to 31	

Calendar

This model is equipped with a calendar function; however, the calendar data cannot be written from the TS series. Thus, time correction must be performed on the PLC side.

Available Memory

The available memory setting range varies depending on the PLC model. Be sure to set within the range available for the PLC. Use [TYPE] when assigning the indirect memory for macro programs.

Memory	TYPE	Remarks
M (internal memory)	00H	MW as word device
Q (output)	01H	QW as word device *1
I (input)	02H	IW as word device *1
R (internal memory)	03H	RW as word device
W (internal memory)	04H	WW as word device
F (system flag)	05H	FW as word device; FW0 to FW1919: read only
K (PID flag)	06H	KW as word device
L (link flag)	07H	LW as word device
N (P2P flag)	08H	NW as word device
U (analog data register)	09H	UW as word device *1

*1 The assigned memory is indicated when editing the screen as shown on the right.

Example: Q 0 . 0 . 0

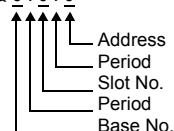

Indirect Memory Designation

- For the address number of 0 to 65535:

	15	8	7	0
n+0	Model		Memory type	
n+1	Address No.			
n+2	Expansion code		Bit designation	
n+3	00		Station number	

- For the address number of 65536 or greater:

	15	8	7	0
n+0	Model		Memory type	
n+1	Lower address No.			
n+2	Higher address No.			
n+3	Expansion code		Bit designation	
n+4	00		Station number	

- Using Q or I device

- Word access

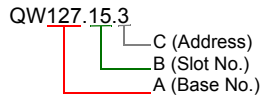

$$\text{Address number} = A \times 64 + B \times 4 + C = 127 \times 64 + 15 \times 4 + 3 = 8191$$

Specify "8191" (DEC) for the address number.

- Bit access

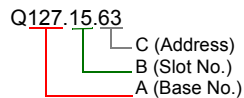

$$\begin{aligned} \text{Address number} &= A \times 64 + B \times 4 + (\text{quotient of } C \text{ divided by } 16) \\ &= 127 \times 64 + 15 \times 4 + (63 \div 16) = 8191 \end{aligned}$$

$$\text{Bit designation} = \text{remainder when } C \text{ is divided by } 16 = (63 \div 16) = 15$$

Specify "8191" (DEC) for the address number, and "15" (DEC) for the bit designation.

- Using U device

- Word access

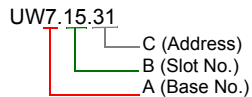

$$\text{Address number} = A \times 512 + B \times 32 + C = 7 \times 512 + 15 \times 32 + 31 = 4095$$

Specify "4095" (DEC) for the address number.

- Bit access

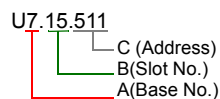

$$\begin{aligned} \text{Address number} &= A \times 512 + B \times 32 + (\text{quotient of } C \text{ divided by } 16) \\ &= 7 \times 512 + 15 \times 32 + (511 \div 16) = 4095 \end{aligned}$$

Specify "4095" (DEC) for the address number, and "15" (DEC) for the bit designation.

25.1.11 XGT / XGI Series CPU

Communication Setting

Editor

Communication setting

(Underlined setting: default)

Item	Setting	Remarks
Connection Mode	<u>1:1</u> / Multi-link2 / Multi-link2 (Ethernet)	
Signal Level	<u>RS-232C</u>	
Baud Rate	<u>115200</u> bps	
Data Length	<u>8</u> bits	
Stop Bit	<u>1</u> bit	
Parity	<u>None</u>	

PLC

No particular setting is necessary on the PLC.

Baud rate: 115200 bps, data length: 8 bits, without parity, stop bit: 1 bit (fixed)

Calendar

This model is equipped with a calendar function; however, the calendar data cannot be written from the TS series. Thus, time correction must be performed on the PLC side.

Available Memory

The available memory setting range varies depending on the PLC model. Be sure to set within the range available for the PLC. Use [TYPE] when assigning the indirect memory for macro programs.

Memory	TYPE	Remarks
M (internal memory)	00H	MW as word device; MW0 to MW65535 valid
Q (output)	01H	QW as word device *1
I (input)	02H	IW as word device *1
R (internal memory)	03H	RW as word device
W (internal memory)	04H	WW as word device
F (system flag)	05H	FW as word device; FW0 to FW1919: read only
K (PID flag)	06H	KW as word device
L (link flag)	07H	LW as word device
N (P2P flag)	08H	NW as word device
U (analog data register)	09H	UW as word device *1

*1 The assigned memory is indicated when editing the screen as shown on the right.

Example: QW 0 . 0 . 0

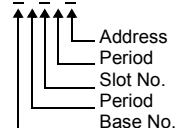

Indirect Memory Designation

	15	8 7	0
n+0	Model		Memory type
n+1	Address No.		
n+2	Expansion code		Bit designation
n+3	00		Station number

- Using Q or I device

- Word access

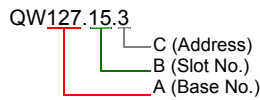

$$\text{Address number} = A \times 64 + B \times 4 + C = 127 \times 64 + 15 \times 4 + 3 = 8191$$

Specify "8191" (DEC) for the address number.

- Bit access

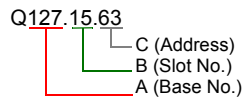

$$\begin{aligned} \text{Address number} &= A \times 64 + B \times 4 + (\text{quotient of } C \text{ divided by } 16) \\ &= 127 \times 64 + 15 \times 4 + (63 \div 16) = 8191 \end{aligned}$$

$$\text{Bit designation} = \text{remainder when } C \text{ is divided by } 16 = (63 \div 16) = 15$$

Specify "8191" (DEC) for the address number, and "15" (DEC) for the bit designation.

- Using U device

- Word access

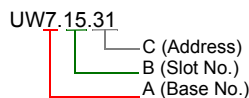

$$\text{Address number} = A \times 512 + B \times 32 + C = 7 \times 512 + 15 \times 32 + 31 = 4095$$

Specify "4095" (DEC) for the address number.

- Bit access

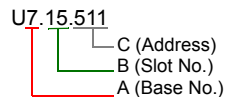

$$\begin{aligned} \text{Address number} &= A \times 512 + B \times 32 + (\text{quotient of } C \text{ divided by } 16) \\ &= 7 \times 512 + 15 \times 32 + (511 \div 16) = 4095 \end{aligned}$$

Specify "4095" (DEC) for the address number, and "15" (DEC) for the bit designation.

25.1.12 XGT / XGI Series (Ethernet)

Communication Setting

Editor

Make the following settings on the editor. For more information, see Appendix 2 Ethernet.

- IP address for the TS unit
 - When specified on the screen data:
[System Setting] → [Ethernet Communication] → [Local Port IP Address]
 - When specified on the TS unit:
Main Menu screen → [Ethernet]
- Port number for the TS unit (for communication with PLC)
[System Setting] → [Device Connection Setting] → [Communication Setting]
- IP address and port number (No. 2004 for TCP/IP or No. 2005 for UDP/IP) for the PLC
[System Setting] → [Device Connection Setting] → [PLC Table]

PLC

Go to [Standard Settings] in XG-PD and set the IP address.
The port numbers are 2004 for TCP/IP and 2005 for UDP/IP (both fixed).
For more information, refer to the PLC manual issued by the manufacturer.

Calendar

This model is equipped with a calendar function; however, the calendar data cannot be written from the TS series. Thus, time correction must be performed on the PLC side.

Available Memory

The contents of "Available Memory" are the same as those described in "25.1.10 XGT / XGI Series CNET".

25.1.13 Wiring Diagrams

When Connected at COM1:

RS-422

Wiring diagram 1 - COM1

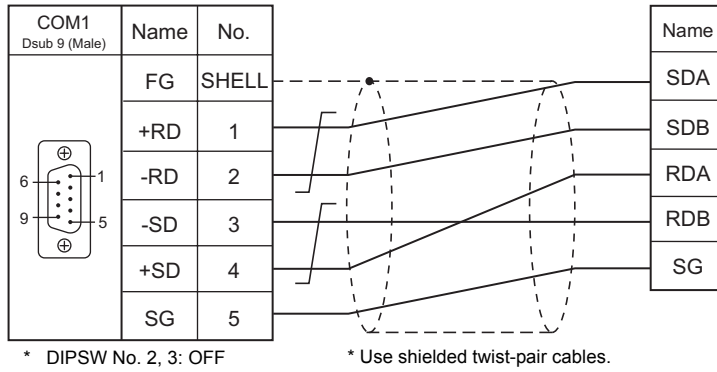

Wiring diagram 2 - COM1

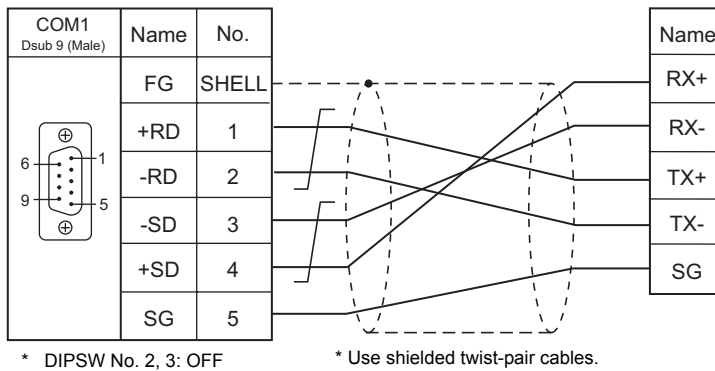

When Connected at COM2:

RS-232C

Wiring diagram 1 - COM2

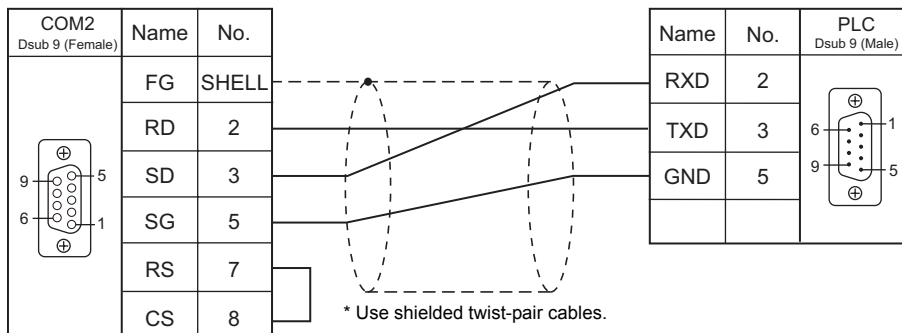

Wiring diagram 2 - COM2

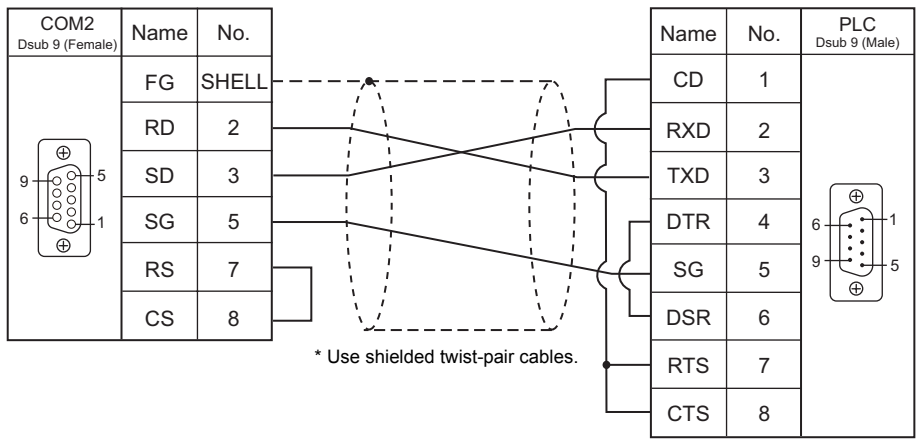

When Connected at COM3:

RS-485

Wiring diagram 1 - COM3

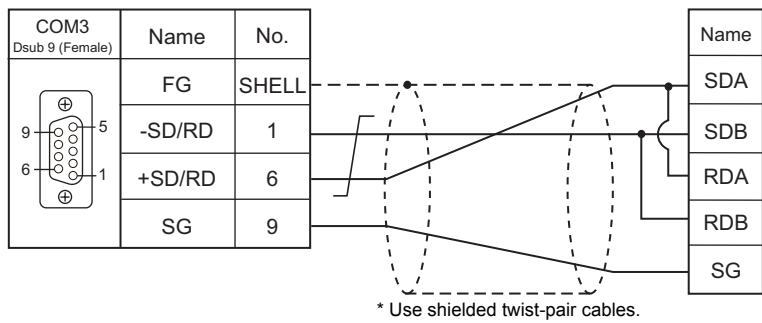

Wiring diagram 2 - COM3

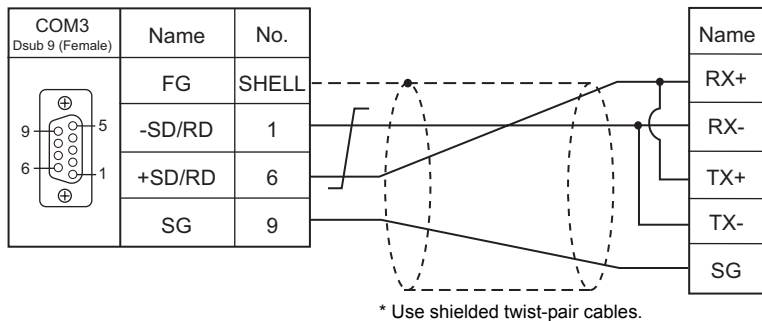

26. MITSUBISHI ELECTRIC

26.1 PLC Connection

26.2 Temperature Controller/Servo/Inverter Connection

26.1 PLC Connection

Serial Connection

A/QnA/QnH/L Series Standard Type Link Unit

PLC Selection on the Editor	CPU	Unit/Port	Signal Level	TS Port	Connection	Ladder Transfer *1
A series link	A1, A2, A3 A1N, A2N, A3N A3H, A3M, A73 A2A, A3A	AJ71C24 AJ71C24-S3 AJ71C24-S6 AJ71C24-S8 AJ71UC24	RS-232C	COM2	Wiring diagram 2 - COM2	×
			RS-422	COM1	Hakko Electronics "D9-MI4-0T" Wiring diagram 1 - COM1	
			RS-485	COM3	Wiring diagram 1 - COM3	
	A2U, A3U, A4U	AJ71UC24	RS-232C	COM2	Wiring diagram 2 - COM2	
			RS-422	COM1	Hakko Electronics "D9-MI4-0T" Wiring diagram 1 - COM1	
			RS-485	COM3	Wiring diagram 1 - COM3	
	A0J2, A0J2H	A0J2C214-S1	RS-232C	COM2	Wiring diagram 2 - COM2	
			RS-422	COM1	Hakko Electronics "D9-MI4-0T" Wiring diagram 1 - COM1	
			RS-485	COM3	Wiring diagram 1 - COM3	
	A2US	A1SJ71UC24-R2 A1SJ71UC24-PRF	RS-232C	COM2	Hakko Electronics "D9-MI2-09" + Gender changer Wiring diagram 1 - COM2	
					Hakko Electronics "D9-MI4-0T" Wiring diagram 1 - COM1	
		A1SJ71UC24-R4	RS-422	COM1	Wiring diagram 1 - COM1	
			RS-485	COM3	Wiring diagram 1 - COM3	
	A1S, A1SJ, A2S	A1SJ71C24-R2 A1SJ71C24-PRF	RS-232C	COM2	Hakko Electronics "D9-MI2-09" + Gender changer Wiring diagram 1 - COM2	
					Hakko Electronics "D9-MI4-0T" Wiring diagram 1 - COM1	
		A1SJ71C24-R4	RS-422	COM1	Wiring diagram 1 - COM1	
			RS-485	COM3	Wiring diagram 1 - COM3	
	A2CCPUC24	CPU with built-in link port	RS-232C	COM2	Hakko Electronics "D9-MI2-09" + Gender changer Wiring diagram 1 - COM2	
	QnH (A mode)	A1SJ71UC24-R2 A1SJ71UC24-R4	RS-232C	COM2	Wiring diagram 1 - COM2	
			RS-422	COM1	Hakko Electronics "D9-MI4-0T" Wiring diagram 1 - COM1	
RS-485			COM3	Wiring diagram 1 - COM3		
QnA series link	Q2A, Q3A, Q4A	AJ71QC24 AJ71QC24N	RS-232C	COM2	Wiring diagram 2 - COM2	
			RS-422	COM1	Hakko Electronics "D9-MI4-0T" Wiring diagram 1 - COM1	
		AJ71QC24-R4(CH1)	RS-422	COM1	Wiring diagram 2 - COM1	
		AJ71QC24-R4(CH2)	RS-422	COM1	Hakko Electronics "D9-MI4-0T" Wiring diagram 1 - COM1	
	Q2ASx	A1SJ71QC24 A1SJ71QC24N A1SJ71QC24-R2	RS-232C	COM2	Hakko Electronics "D9-MI2-09" + Gender changer Wiring diagram 1 - COM2	
			RS-422	COM1	Hakko Electronics "D9-MI4-0T" Wiring diagram 1 - COM1	
QnH (Q) series link	Q02, Q02H Q06H, Q12H Q25H Q00, Q01, Q00J Q00UJ, Q00U Q01U, Q02U Q03UD(E) Q04UD(E)H Q06UD(E)H Q10UD(E)H Q13UD(E)H Q20UD(E)H Q26UD(E)H Q50UDEH, Q100UDEH	QJ71C24 QJ71C24N QJ71C24-R2 QJ71C24N-R2 QJ71C24N-R4	RS-232C	COM2	Hakko Electronics "D9-MI2-09" + Gender changer Wiring diagram 1 - COM2	
			RS-422	COM1	Hakko Electronics "D9-MI4-0T" Wiring diagram 1 - COM1	

PLC Selection on the Editor	CPU	Unit/Port	Signal Level	TS Port	Connection	Ladder Transfer *1
QnH (Q) series link (multi CPU)	Q02, Q02H Q06H, Q12H Q25H Q00UJ, Q00U Q01U, Q02U Q03UD(E) Q04UD(E)H Q06UD(E)H Q10UD(E)H Q13UD(E)H Q20UD(E)H Q26UD(E)H Q50UDEH, Q100UDEH	QJ71C24 QJ71C24N QJ71C24-R2 QJ71C24N-R2 QJ71C24N-R4	RS-232C	COM2	Hakko Electronics "D9-MI2-09" + Gender changer Wiring diagram 1 - COM2	×
			RS-422	COM1	Hakko Electronics "D9-MI4-0T" Wiring diagram 1 - COM1	
L series link	L02CPU L26CPU-BT	LJ71C24 LJ71C24-R2	RS-232C	COM2	Hakko Electronics "D9-MI2-09" + Gender changer Wiring diagram 1 - COM2	×
			RS-422	COM1	Hakko Electronics "D9-MI4-0T" Wiring diagram 1 - COM1	

*1 For the ladder transfer function, see "Appendix 5 Ladder Transfer Function".

QnH/QnU Series/Q170M CPU

PLC Selection on the Editor	CPU	Port	Signal Level	TS Port	Connection	Ladder Transfer *1
QnH (Q) series CPU	Q02, Q02H Q06H	Tool port	RS-232C	COM2	Hakko Electronics "D9-QCPU2" + Gender changer	○
QnH (Q) series CPU (multi CPU)	Q12H Q25H	Tool port *2				
Q00J/00/01 CPU	Q00J, Q00, Q01	Tool port				
QnU series CPU	Q00UJ, Q00U Q01U, Q02U Q03UD, Q04UDH Q06UDH, Q10UDH Q13UDH, Q20UDH Q26UDH	Tool port				
Q170M CPU (multi CPU)	Q170M	Tool port				

*1 For the ladder transfer function, see "Appendix 5 Ladder Transfer Function".

*2 Available for the CPU function version B or later.

FX Series

PLC Selection on the Editor	CPU	Port	Signal Level	TS Port	Connection	Ladder Transfer ^{*1}		
FX2N/1N series CPU	FX2N FX1N FX2NC FX1NC	Tool port ^{*1}	RS-422	COM1	Hakko Electronics "D9-MI4-FX"	○		
FX1S series CPU	FX1S				"D9-MB-CPUQ" + Mitsubishi "FX-20P-CADP"			
FX series link (A protocol)	FX2N	FX2N-232-BD	RS-232C	COM2	Hakko Electronic "D9-MI2-FX2N-2M" + Gender changer Wiring diagram 3 - COM2	×		
		FX2N-485-BD	RS-422	COM1	Hakko Electronics "D9-MI4-0T" ^{*2} Wiring diagram 1 - COM1			
			RS-485	COM3	Wiring diagram 1 - COM3			
		FX2N-422-BD	RS-422	COM1	Hakko Electronics "D9-MI4-FX"			
	FX1N FX1S	FX1N-232-BD	RS-232C	COM2	Hakko Electronic "D9-MI2-FX2N-2M" + Gender changer Wiring diagram 3 - COM2			
		FX1N-485-BD	RS-422	COM1	Hakko Electronics "D9-MI4-0T" ^{*2} Wiring diagram 1 - COM1			
			RS-485	COM3	Wiring diagram 1 - COM3			
		FX1N-422-BD	RS-422	COM1	Hakko Electronics "D9-MI4-FX"			
	FX0N FX1NC FX2NC	FX0N-232ADP	RS-232C	COM2	Wiring diagram 4 - COM2			
		FX2NC-232ADP	RS-232C	COM2	Hakko Electronics "D9-MI2-FX2N-2M" + Gender changer Wiring diagram 3 - COM2			
			RS-422	COM1	Hakko Electronics "D9-MI4-0T" ^{*2} Wiring diagram 1 - COM1			
		FX0N-485ADP FX2NC-485ADP	RS-485	COM3	Wiring diagram 1 - COM3			
	FX-3U/3UC/3G series CPU	FX-3U FX-3UC FX-3G	Tool port ^{*1}	RS-422	COM1		Hakko Electronics "D9-MI4-FX" Hakko Electronics "D9-MB-CPUQ" + Mitsubishi "FX-20P-CADP"	○
	FX3U/3UC/3G series link (A protocol)	FX-3G	FX3G-232-BD	RS-232C	COM2		Hakko Electronics "D9-MI2-FX2N-2M" + Gender changer Wiring diagram 3 - COM2	×
FX3G-485-BD			RS-422	COM1	Hakko Electronics "D9-MI4-0T" ^{*2} Wiring diagram 1 - COM1			
			RS-485	COM3	Wiring diagram 1 - COM3			
FX3U		FX3U-232-BD	RS-232C	COM2	Hakko Electronics "D9-MI2-FX2N-2M" + Gender changer Wiring diagram 3 - COM2			
		FX3U-485-BD	RS-422	COM1	Hakko Electronics "D9-MI4-0T" ^{*2} Wiring diagram 1 - COM1			
			RS-485	COM3	Wiring diagram 1 - COM3			
FX3UC		FX3U-232-BD FX3U-232-ADP	RS-232C	COM2	Hakko Electronics "D9-MI2-FX2N-2M" + Gender changer Wiring diagram 3 - COM2			
		FX3U-485ADP FX3U-485BD	RS-422	COM1	Hakko Electronics "D9-MI4-0T" ^{*2} Wiring diagram 1 - COM1			
			RS-485	COM3	Wiring diagram 1 - COM3			

*1 For the ladder transfer function, see "Appendix 5 Ladder Transfer Function".

*2 "D9-MI4-0T" is equipped with the Y-shaped terminal at the PLC side. Modification is necessary before use.

Ethernet Connection

QnA/QnH/Q170/L Series

PLC Selection on the Editor	CPU	Unit	TCP/IP	UDP/IP	Port No.	Keep Alive ^{*1}	Ladder Transfer ^{*2}
QnA series (Ethernet)	Q2A, Q3A, Q4A	AJ71QE71 AJ71QE71-B5	×	○			
	Q2ASx	A1SJ71QE71-B2 A1SJ71QE71-B5					
QnH (Q) series (Ethernet)	Q02, Q02H Q06H Q12H Q25H Q00J, Q00, Q01	QJ71E71 QJ71E71-B2 QJ71E71-100	×	○	Auto-open: 5000		
	Q02U Q03UD Q04UDH, Q06UDH Q10UDH, Q13UDH Q20UDH, Q26UDH	QJ71E71-B2 QJ71E71-100	×	○	Open setting: As desired (max. 16 units)		
	Q03UDE Q04UDEH, Q06UDEH Q10UDEH, Q13UDEH Q20UDEH, Q26UDEH Q50UDEH, Q100UDEH	CPU with built-in Ethernet	×	○	Open setting: As desired (max. 16 units)		
QnH (Q) series (Ethernet ASCII)	Q02, Q02H Q06H Q12H Q25H Q00J, Q00, Q01	QJ71E71 QJ71E71-B2 QJ71E71-100	×	○			
	Q02U Q03UD Q04UDH, Q06UDH Q10UDH, Q13UDH Q20UDH, Q26UDH	QJ71E71-B2 QJ71E71-100	×	○	Open setting: As desired (max. 16 units)		
	Q03UDE Q04UDEH, Q06UDEH Q10UDEH, Q13UDEH Q20UDEH, Q26UDEH Q50UDEH, Q100UDEH	CPU with built-in Ethernet	×	○			
QnH (Q) series (multi CPU) (Ethernet)	Q02, Q02H Q06H Q12H Q25H	QJ71E71 QJ71E71-B2 QJ71E71-100	×	○	Auto-open: 5000	○	×
	Q02U Q03UD Q04UDH, Q06UDH Q10UDH, Q13UDH Q20UDH, Q26UDH	QJ71E71-B2 QJ71E71-100	×	○	Open setting: As desired (max. 16 units)		
	Q03UDE Q04UDEH, Q06UDEH Q10UDEH, Q13UDEH Q20UDEH, Q26UDEH Q50UDEH, Q100UDEH		×	○	Open setting (max. 16 units)		
QnH (Q) series (multi CPU) (Ethernet)	Q02, Q02H Q06H Q12H Q25H	QJ71E71 QJ71E71-B2 QJ71E71-100	×	○			
	Q02U Q03UD Q04UDH, Q06UDH Q10UDH, Q13UDH Q20UDH, Q26UDH	QJ71E71-B2 QJ71E71-100	×	○	Open setting: As desired (max. 16 units)		
	Q03UDE Q04UDEH, Q06UDEH Q10UDEH, Q13UDEH Q20UDEH, Q26UDEH Q50UDEH, Q100UDEH		×	○			
QnU series (Built-in Ethernet)	Q03UDE Q04UDEH, Q06UDEH Q10UDEH, Q13UDEH Q20UDEH, Q26UDEH Q50UDEH, Q100UDEH	CPU with built-in Ethernet	○	○	Open setting: As desired (max. 16 units)		
Q170 series (multi CPU) (Ethernet)	Q170M Q172DCPU-S1 Q173DCPU-S1	CPU with built-in Ethernet	○	○	Open setting: As desired (max. 16 units)		
L series (Built-in Ethernet)	L02CPU L26CPU-BT	CPU with built-in Ethernet	○	○	Open setting: As desired (max. 16 units)		

*1 For KeepAlive functions, see "Appendix 2 Ethernet".

*2 For the ladder transfer function, see "Appendix 5 Ladder Transfer Function".

FX Series

PLC Selection on the Editor	CPU	Unit	TCP/IP	UDP/IP	Port No.	Keep Alive ^{*2}	Ladder Transfer ^{*3}
FX3U series (Ethernet)	FX3U (Version V2.21 or greater)	FX3U-ENET-L	×	○	Open setting: As desired (max. 2 units)	○	×
		FX3U-ENET			Open setting: As desired (max. 4 units)		
	FX3UC ^{*1} (Version V2.21 or greater)	FX3U-ENET-L	×	○	Open setting: As desired (max. 2 units)		

*1 FX2NC-CNV-IF or FX3UC-1PS-5V (Mitsubishi Electric) is required.

*2 For KeepAlive functions, see "Appendix 2 Ethernet".

*3 For the ladder transfer function, see "Appendix 5 Ladder Transfer Function".

26.1.1 A Series Link

Communication Setting

Editor

Communication setting

(Underlined setting: default)

Item	Setting	Remarks
Connection Mode	<u>1</u> : 1 / 1 : n / Multi-link / Multi-link2	
Signal Level	<u>RS-232C</u> / RS-422/485	
Baud Rate	4800 / 9600 / <u>19200</u> bps	
Transmission Mode	<u>Transmission Mode 1</u> / Transmission Mode 4	Transmission Mode 1: Without CR/LF Transmission Mode 4: With CR/LF
Data Length	<u>7</u> / 8 bits	
Stop Bit	<u>1</u> / 2 bits	
Parity	None / Odd / <u>Even</u>	
Target Port No.	<u>0</u> to 31	

PLC

Be sure to match the settings to those made on the [Communication Setting] tab window of the editor.

Mode setting

Mode	Setting	Contents	
	1	RS-232C	Dedicated protocol MODE 1
	4		Dedicated protocol MODE 4
	5	RS-422	Dedicated protocol MODE 1
	8		Dedicated protocol MODE 4

Station number setting

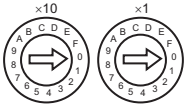
Station No.	Setting	Contents
	0 to 31	Station number ×10: the tens place ×1: the ones place

Transmission setting

AJ71UC24

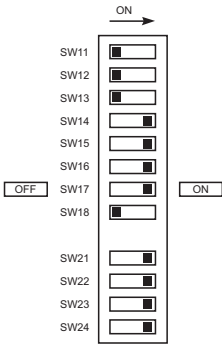
Switch	Contents	OFF	ON	Example: RS-232C, 19200 bps 
SW11	Main channel	RS-232C	RS-422	
SW12	Data bit	7	8	
SW13	Baud rate	9600	19200	
		ON	OFF	
		OFF	ON	
SW14		ON	ON	
SW15		ON	ON	
SW16	Parity bit	Not provided	Provided	
SW17	Parity	Odd	Even	
SW18	Stop bit	1	2	
SW21	Sum check	Not provided	Provided	
SW22	Write while running	Disabled	Enabled	
SW23	Standard type link unit / multi-drop link unit	Multi	Standard	
SW24	Master station / local station	-	-	

A1SJ71C24-R2, A1SJ71UC24-R2

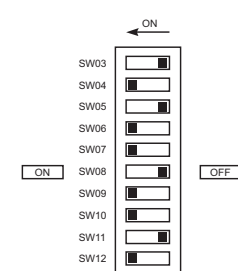
Switch	Contents	ON	OFF	Example: RS-232C, 19200 bps 
SW03	Not used	-	-	
SW04	Write while running	Enabled	Disabled	
		9600	19200	
SW05	Baud rate	ON	OFF	
SW06		OFF	ON	
SW07		ON	ON	
SW08	Data bit	8	7	
SW09	Parity bit	Provided	Not provided	
SW10	Parity	Even	Odd	
SW11	Stop bit	2	1	
SW12	Sum check	Provided	Not provided	

A1SJ71UC24-R4, A1SJ71C24-R4

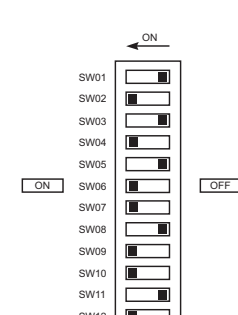
Switch	Contents	ON	OFF	Example: RS-422, 19200 bps 
SW01	Master station / local station	-	-	
SW02	Standard type link unit / multi-drop link unit	Standard	Multi	
SW03	Not used	-	-	
SW04	Write while running	Enabled	Disabled	
		9600	19200	
SW05	Baud rate	ON	OFF	
SW06		OFF	ON	
SW07		ON	ON	
SW08	Data bit	8	7	
SW09	Parity bit	Provided	Not provided	
SW10	Parity	Even	Odd	
SW11	Stop bit	2	1	
SW12	Sum check	Provided	Not provided	

Available Memory

The available memory setting range varies depending on the PLC model. Be sure to set within the range available with the PLC to be used. Use [TYPE] when assigning the indirect memory for macro programs.

Memory	TYPE	Remarks
D (data register)	00H	
W (link register)	01H	
R (file register)	02H	Cannot be set when the CPU is operated by ROM.
TN (timer/current value)	03H	
CN (counter/current value)	04H	
SPU (special unit buffer memory)	05H	*1
M (internal relay)	06H	
L (latch relay)	07H	
B (link relay)	08H	
X (input)	09H	
Y (output)	0AH	
TS (timer/contact)	0BH	
TC (timer/coil)	0CH	
CS (counter/contact)	0DH	
CC (counter/coil)	0EH	
H (link unit buffer memory)	0FH	

*1 The unit number is required in addition to the memory type and address. Convert byte address into word address when entering the data on the editor if the memory device of the link unit is byte address.
For the unit number, set the decimal number of "XXX" included in the station I/O number "xxx0 H" of the link unit. For more information, see page 26-14.

26.1.2 QnA Series Link

Communication Setting

Editor

Communication setting

(Underlined setting: default)

Item	Setting	Remarks
Connection Mode	<u>1</u> : 1 / 1 : n / Multi-link2	
Signal Level	<u>RS-232C</u> / RS-422/485	
Baud Rate	4800 / 9600 / <u>19200</u> / 38400 /57600 / <u>115K</u> bps	
Data Length	8 bits	
Stop Bit	<u>1</u> / 2 bits	
Parity	None / Odd / <u>Even</u>	
Target Port No.	<u>0</u> to 31	

PLC

Be sure to match the settings to those made on the [Communication Setting] tab window of the editor.

Mode setting

Mode	Setting	Contents
	5	Dedicated protocol binary mode Mode 5

Station number setting

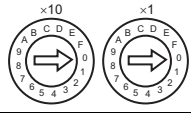
Station No.	Setting	Contents
	0 to 31	Station number ×10: the tens place ×1: the ones place

Transmission setting

AJ71QC24, AJ71QC24N, A1SJ71QC24

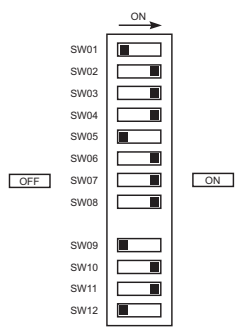
Switch	Contents	OFF	ON	Example: 19200 bps 		
SW01	Operation	Independent	Link			
SW02	Data bit	7	8			
SW03	Parity bit	Not provided	Provided			
SW04	Parity	Odd	Even			
SW05	Stop bit	1	2			
SW06	Sum check	Not provided	Provided			
SW07	Write while running	Disabled	Enabled			
SW08	Setting change	Disabled	Enabled			
SW09	Baud rate *1	9600	19200	38400	57600	115200
SW10		ON	OFF	ON	OFF	ON
SW11		OFF	ON	ON	ON	ON
SW12		ON	ON	ON	OFF	OFF
		OFF	OFF	OFF	ON	ON

*1 AJ71C24 (-R2/-R4): Max. 19200 bps

AJ71C24N (-R2/-R4): Max. 115200 bps (When CH1 and CH2 are used at the same time, a maximum of 115200 bps can be set in total.)

Available Memory

The available memory setting range varies depending on the PLC model. Be sure to set within the range available with the PLC to be used. Use [TYPE] when assigning the indirect memory for macro programs.

Memory	TYPE	Remarks
D (data register)	00H	
W (link register)	01H	
R (file register)	02H	
TN (timer/current value)	03H	
CN (counter/current value)	04H	
SPU (special unit buffer memory)	05H	*1
M (internal relay)	06H	
L (latch relay)	07H	
B (link relay)	08H	
X (input)	09H	
Y (output)	0AH	
TS (timer/contact)	0BH	
TC (timer/coil)	0CH	
CS (counter/contact)	0DH	
CC (counter/coil)	0EH	
H (link unit buffer memory)	0FH	
SD (special register)	10H	
SM (special relay)	11H	
SB (special link relay)	12H	
SW (special link register)	13H	
ZR (file register (for continuous access))	14H	
F (annunciator)	15H	

*1 The unit number is required in addition to the memory type and address. Convert byte address into word address when entering the data on the editor if the memory device of the link unit is byte address. For the unit number, set the decimal number of "XXX" included in the station I/O number "xxx0 H" of the link unit. For more information, see page 26-14.

26.1.3 QnA Series (Ethernet)

Communication Setting

Editor

Make the following settings on the editor. For more information, see “Appendix 2 Ethernet”.

- IP address for the TS unit
 - When specified on the screen data:
[System Setting] → [Ethernet Communication] → [Local Port IP Address]
 - When specified on the TS unit:
Main Menu screen → [Ethernet]
- Port number for the TS unit (for communication with PLC)
[System Setting] → [Device Connection Setting] → [Communication Setting]

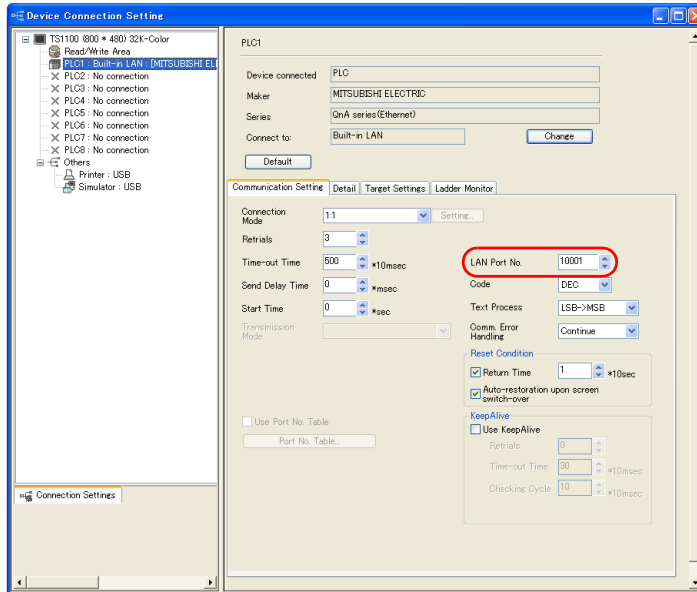

- IP address and port number of the PLC
[System Setting] → [Device Connection Setting] → [PLC Table]

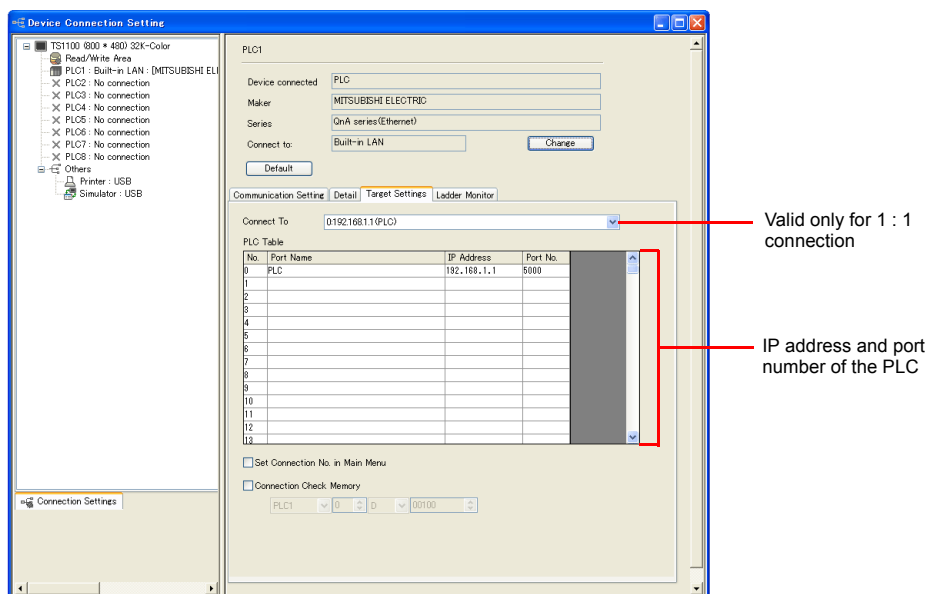

PLC

PC parameter

Make the I/O assignment setting for the Ethernet unit.

Network parameter (Ethernet)

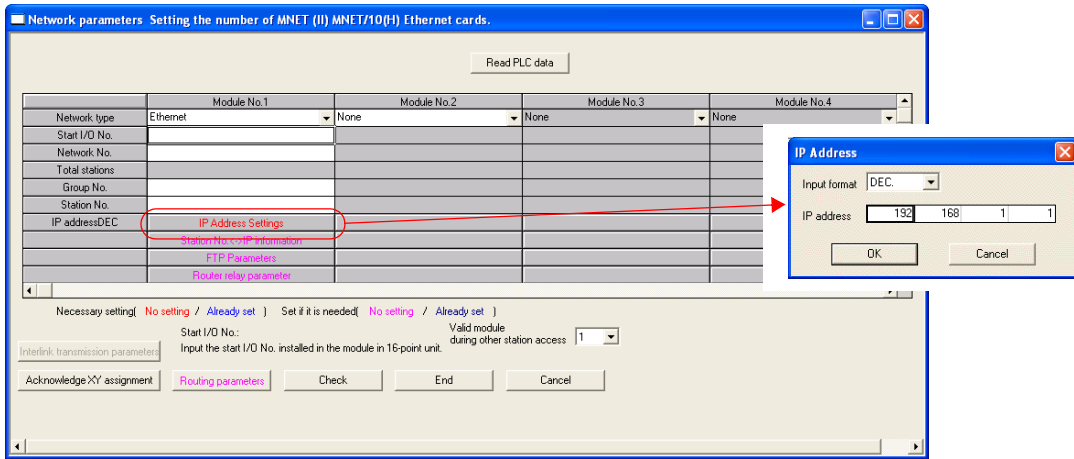

Item	Setting	Remarks
Network type	Ethernet	For more information, refer to the manual of the PLC.
Station I/O No.	Make settings in accordance with the network environment.	
Network No.		
Group No.		
Station No.		
IP address (DEC)		

Port No.

There are two types of ports: one is opened automatically by “auto-open UDP port” (default: 5000 DEC), and the other is opened by open processing.

For more information, refer to the corresponding PLC manual.

Available Memory

The available memory setting range varies depending on the PLC model. Be sure to set within the range available with the PLC to be used. Use [TYPE] when assigning the indirect memory for macro programs.

Memory	TYPE	Remarks
D (data register)	00H	
W (link register)	01H	
R (file register)	02H	
TN (timer/current value)	03H	
CN (counter/current value)	04H	
SPU (special unit buffer memory)	05H	*1
M (internal relay)	06H	
L (latch relay)	07H	
B (link relay)	08H	
X (input)	09H	
Y (output)	0AH	
TS (timer/contact)	0BH	
TC (timer/coil)	0CH	
CS (counter/contact)	0DH	
CC (counter/coil)	0EH	
H (link unit buffer memory)	0FH	
SD (special register)	10H	
SM (special relay)	11H	
SB (special link relay)	12H	
SW (special link register)	13H	
ZR (file register (for continuous access))	14H	
F (annunciator)	15H	

*1 The unit number is required in addition to the memory type and address. Convert byte address into word address when entering the data on the editor if the memory device of the link unit is byte address. For the unit number, set the decimal number of "XXX" included in the station I/O number "xxx0 H" of the link unit. For more information, see page 26-14.

26.1.4 QnH (Q) Series Link

Communication Setting

Editor

Communication setting

(Underlined setting: default)

Item	Setting	Remarks
Connection Mode	<u>1</u> : <u>1</u> / 1 : n / Multi-link2	
Signal Level	<u>RS-232C</u> / RS-422/485	
Baud Rate	4800 / 9600 / 19200 / 38400 / 57600 / <u>115K</u> bps	
Data Length	<u>8</u> bits	
Stop Bit	<u>1</u> / 2 bits	
Parity	None / Odd / <u>Even</u>	
Target Port No.	<u>0</u> to 31	

PLC (PC Parameter)

Switch setting for I/O and intelligent function module

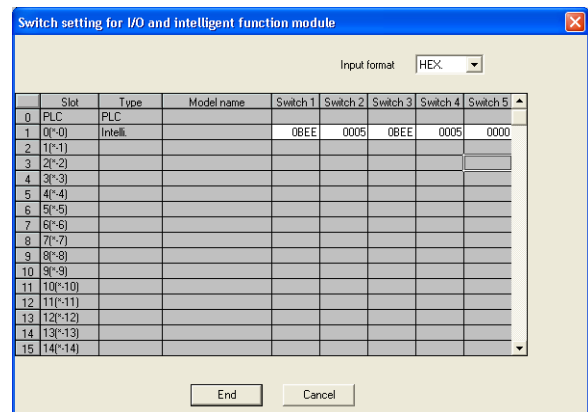
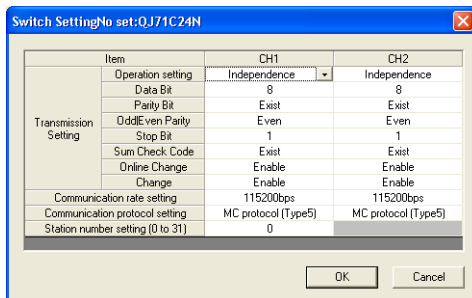

Switch	Contents	Example																																																		
Switch 1	<p>CH1: baud rate, transmission setting</p> <p>Bit 15 - 8 7 - 0</p> <p>Baud rate Transmission setting</p> <table border="1"> <thead> <tr> <th>bps</th> <th>Setting</th> </tr> </thead> <tbody> <tr> <td>4800</td> <td>04H</td> </tr> <tr> <td>9600</td> <td>05H</td> </tr> <tr> <td>19200</td> <td>07H</td> </tr> <tr> <td>38400</td> <td>09H</td> </tr> <tr> <td>57600</td> <td>0AH</td> </tr> <tr> <td>115200</td> <td>0BH</td> </tr> </tbody> </table> <table border="1"> <thead> <tr> <th>Bit</th> <th>Contents</th> <th>OFF</th> <th>ON</th> </tr> </thead> <tbody> <tr> <td>0</td> <td>Operation</td> <td>Independent</td> <td>Link</td> </tr> <tr> <td>1</td> <td>Data bit</td> <td>7</td> <td>8</td> </tr> <tr> <td>2</td> <td>Parity bit</td> <td>Not provided</td> <td>Provided</td> </tr> <tr> <td>3</td> <td>Parity</td> <td>Odd</td> <td>Even</td> </tr> <tr> <td>4</td> <td>Stop bit</td> <td>1</td> <td>2</td> </tr> <tr> <td>5</td> <td>Sum check</td> <td>Not provided</td> <td>Provided</td> </tr> <tr> <td>6</td> <td>Write while running</td> <td>Prohibited</td> <td>Allowed</td> </tr> <tr> <td>7</td> <td>Setting change</td> <td>Prohibited</td> <td>Allowed</td> </tr> </tbody> </table>	bps	Setting	4800	04H	9600	05H	19200	07H	38400	09H	57600	0AH	115200	0BH	Bit	Contents	OFF	ON	0	Operation	Independent	Link	1	Data bit	7	8	2	Parity bit	Not provided	Provided	3	Parity	Odd	Even	4	Stop bit	1	2	5	Sum check	Not provided	Provided	6	Write while running	Prohibited	Allowed	7	Setting change	Prohibited	Allowed	0BEEH 115 kbps 8 bits 1 bit Even
bps	Setting																																																			
4800	04H																																																			
9600	05H																																																			
19200	07H																																																			
38400	09H																																																			
57600	0AH																																																			
115200	0BH																																																			
Bit	Contents	OFF	ON																																																	
0	Operation	Independent	Link																																																	
1	Data bit	7	8																																																	
2	Parity bit	Not provided	Provided																																																	
3	Parity	Odd	Even																																																	
4	Stop bit	1	2																																																	
5	Sum check	Not provided	Provided																																																	
6	Write while running	Prohibited	Allowed																																																	
7	Setting change	Prohibited	Allowed																																																	
Switch 2	CH1: communication protocol	MC protocol mode 5 binary code	0005H																																																	
Switch 3	CH2: baud rate, transmission setting (the same as those for switch 1)		0BEEH																																																	
Switch 4	CH2: communication protocol	MC protocol mode 5 binary code	0005H																																																	
Switch 5	Station number setting	0 to 31	0000H																																																	

Available Memory

The available memory setting range varies depending on the PLC model. Be sure to set within the range available with the PLC to be used. Use [TYPE] when assigning the indirect memory for macro programs.

Memory	TYPE	Remarks
D (data register)	00H	
W (link register)	01H	
R (file register)	02H	
TN (timer/current value)	03H	
CN (counter/current value)	04H	
SPU (special unit buffer memory)	05H	*1
M (internal relay)	06H	
L (latch relay)	07H	
B (link relay)	08H	
X (input)	09H	
Y (output)	0AH	
TS (timer/contact)	0BH	
TC (timer/coil)	0CH	
CS (counter/contact)	0DH	
CC (counter/coil)	0EH	
H (link unit buffer memory)	0FH	
SD (special register)	10H	
SM (special relay)	11H	
SB (special link relay)	12H	
SW (special link register)	13H	
ZR (file register (for continuous access))	14H	
F (annunciator)	15H	
SS (totalizing timer/contact)	16H	
SC (totalizing timer/coil)	17H	
SN (totalizing timer/current value)	18H	
Z (index register)	19H	

*1 The unit number is required in addition to the memory type and address. Convert byte address into word address when entering the data on the editor if the memory device of the link unit is byte address.
For the unit number, set the decimal number of "XXX" included in the station I/O number "xxx0 H" of the link unit.

Example:

When the following settings are made for "Q02HCPU" and connection is established:

The screenshot shows the 'Q parameter setting' dialog box with the 'I/O assignment' tab selected. The table below shows the configuration for slots 0 through 7. Slot 0 is the PLC. Slots 1, 2, and 4 are assigned modules: QJ71C24N (Intelli), Q64AD (Input), and Q64DAN (Output) respectively. The 'XY No.' column in the 'Acknowledge XY Assignment' dialog shows addresses 0060 through 0130. A red box highlights '0080' in the XY No. column, with an arrow pointing to it from a text box that reads 'Decimal number of "XXX" of the station I/O No. of "xxx0 H" = Unit No.'

Slot	PLC	Type	Model name	Points	Start:XY
0	PLC				
1	QJ71C24N	Intelli	QJ71C24N	32points	0060
2	Q64AD	Input	Q64AD	16points	00A0
3	Q64DAN	Output	Q64DAN	16points	00E0
4					
5					
6					
7					

XY No.	Network	Type	I/O Assign	Slot	Module type	Points	Model name	Duplication
0060								
0070								
0080		I/O assignment	0[*]-0	Intelli	32		QJ71C24N	
0090		I/O assignment	0[*]-0	Intelli	32		QJ71C24N	
00A0		I/O assignment	1[*]-1	Input	16		Q64AD	
00B0		I/O assignment	2[*]-2	Output	16		Q64DAN	
00C0								
00D0								
00E0								
00F0								
0100								
0110								
0120								
0130								

- With the use of buffer memory of the serial communication unit: Unit No. = "8" (DEC)
- With the use of buffer memory of the input unit: Unit No. = "10" (DEC)
- With the use of buffer memory of the output unit: Unit No. = "11" (DEC)

26.1.5 QnH (Q) Series CPU

Communication Setting

Editor

Communication setting

(Underlined setting: default)

Item	Setting	Remarks
Connection mode	<u>1:1</u> / Multi-link2	
Signal level	RS-232C	
Baud rate	9600 / 19200 / 38400 / 57600 / <u>115K</u> bps	
Data length	8 bits	
Stop bit	1 bit	
Parity	Odd	

PLC

No particular setting is necessary on the PLC.

Available Memory

The available memory setting range varies depending on the PLC model. Be sure to set within the range available with the PLC to be used. Use [TYPE] when assigning the indirect memory for macro programs.

Memory	TYPE	Remarks
D (data register)	00H	
W (link register)	01H	
R (file register)	02H	
TN (timer/current value)	03H	
CN (counter/current value)	04H	
SPU (special unit buffer memory)	05H	*1
M (internal relay)	06H	
L (latch relay)	07H	
B (link relay)	08H	
X (input)	09H	
Y (output)	0AH	
TS (timer/contact)	0BH	
TC (timer/coil)	0CH	
CS (counter/contact)	0DH	
CC (counter/coil)	0EH	
SD (special register)	10H	
SM (special relay)	11H	
SB (special link relay)	12H	
SW (special link register)	13H	
ZR (file register (for continuous access))	14H	
F (annunciator)	15H	
SS (totalizing timer/contact)	16H	
SC (totalizing timer/coil)	17H	
SN (totalizing timer/current value)	18H	
Z (index register)	19H	

*1 The unit number is required in addition to the memory type and address. Convert byte address into word address when entering the data on the editor if the memory device of the link unit is byte address. For the unit number, set the decimal number of "XXX" included in the station I/O number "xxx0 H" of the link unit. For more information, see page 26-14.

26.1.6 QnH (Q) Series (Ethernet)

Communication Setting

Editor

Make the following settings on the editor. For more information, see “Appendix 2 Ethernet”.

- IP address for the TS unit
 - Setting on the V-SFT
[IP Address Setting] tab window ([System setting] → [Ethernet Communication] → [Local Port IP Address])
 - Setting on the TS Series
[Ethernet] screen on the Main Menu screen.
- Port number for the TS unit (for PLC communication)
[Communication Setting] tab window ([System Setting] → [Device Connection Setting])
- Others
[Communication Setting] tab window ([System Setting] → [Device Connection Setting])
 - When connecting to the Ethernet unit on the PLC’s base, check the Batch Readout of Multiple Blocks] check box.
 - When connecting to the built-in Ethernet port on the PLC, check the Random Readout] check box.

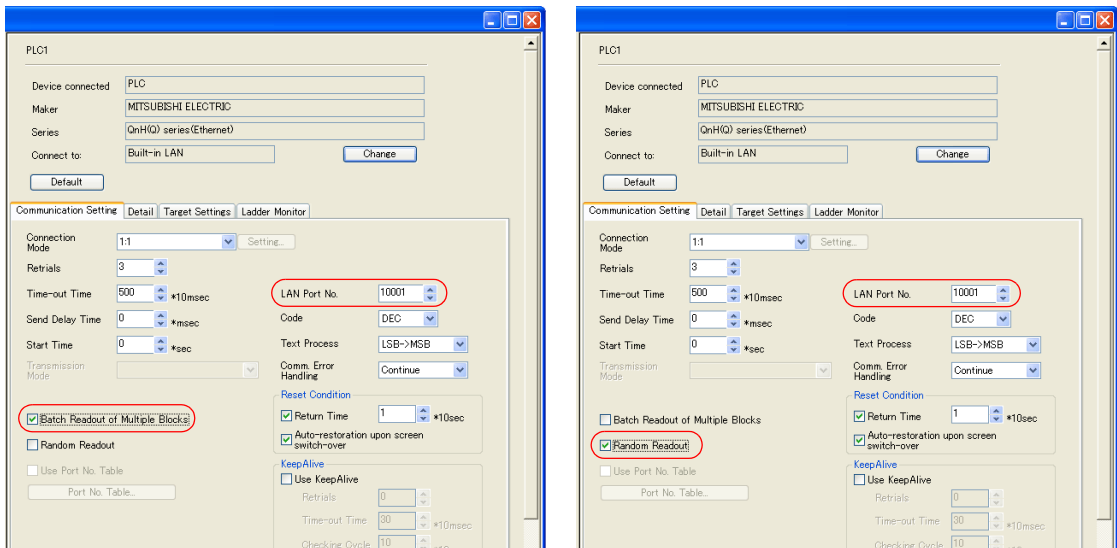

- PLC’s IP address and port number
[PLC Table] in the [Target Settings] tab window ([System Setting] → [Device Connection Setting] → [Target Settings])

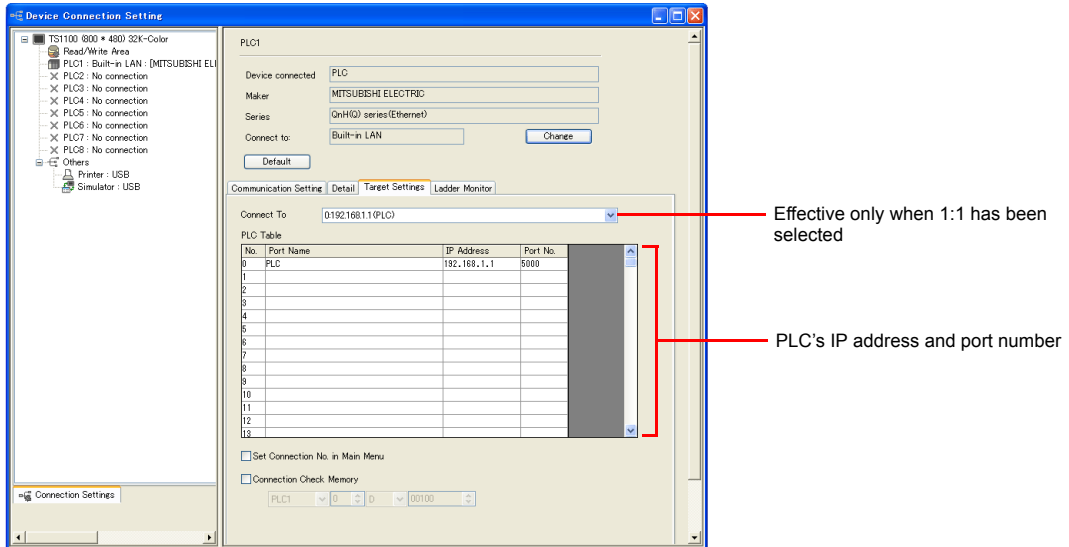

PLC

Make the PLC setting using the programming tool “GX-Developer”. For more information, refer to the PLC manual issued by the manufacturer.

Ethernet unit

PC parameter

Make the I/O assignment setting for the Ethernet unit.

Network parameter (Ethernet)

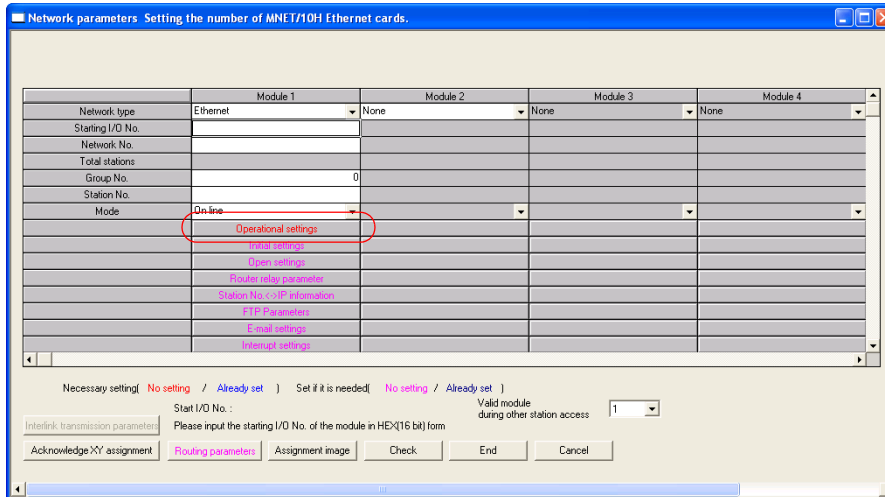

Item	Setting	Remarks
Network type	Ethernet	For more information, refer to the manual of the PLC.
Station I/O No.		
Network No.	Make settings in accordance with the network environment.	
Group No.		
Station No.		

Ethernet operations

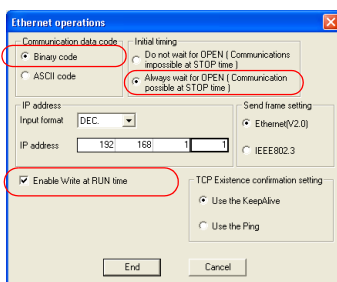

Item	Setting	Remarks
Communication data code	Binary code	
Initial timing	Always wait for OPEN (Communication possible at STOP time)	
IP address (DEC)	Make settings in accordance with the network environment.	
<input type="checkbox"/> Enable Write at RUN time	Checked	It is not possible to write value from TS to PLC when unchecked. If so, "error code received 7167" occurs.

Port No.

There are two types of ports: one is opened automatically by "auto-open UDP port" (default: 5000 DEC), and the other is opened by open processing. When using the open processing, make settings for [Open settings] on the [Network parameters] dialog. For more information, refer to the corresponding PLC manual.

Built-in Ethernet port

PC parameter

Make the settings for the IP address and the open settings in the [Built-in Ethernet port] tab window.

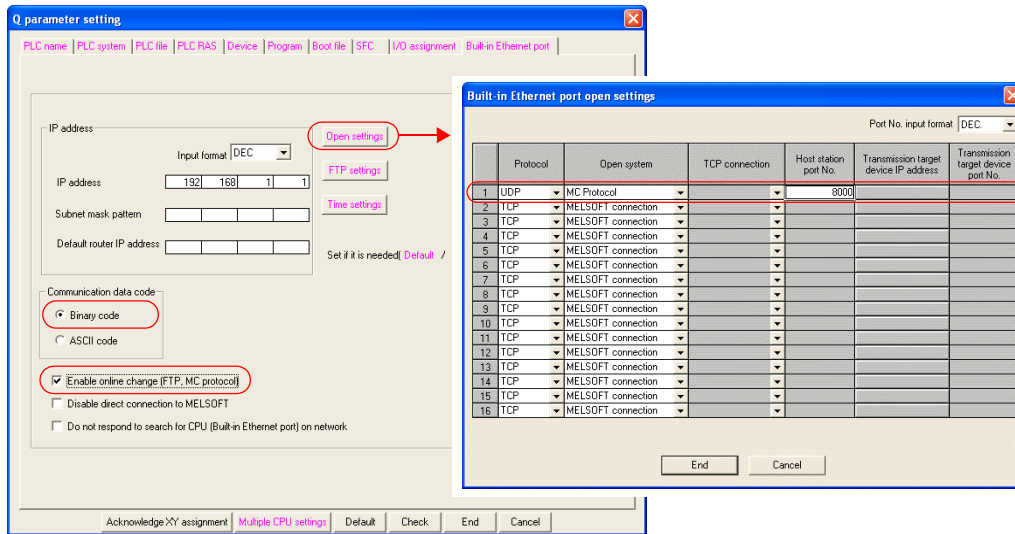

Item	Setting	Remarks
IP address (DEC)	Make settings in accordance with the network environment.	For more information, refer to the manual of the PLC.
Communication data code	Binary code	
<input type="checkbox"/> Enable online change (FTP, MC protocol)	Checked	It is not possible to write value from TS to PLC when unchecked. If so, "error code received 7167" occurs.
Protocol	UDP	
Open system	MC Protocol	
Host station port No. (DEC)	Make settings in accordance with the network environment.	It is not possible to set it from No. 5000 to 5009.

Available Memory

The available memory setting range varies depending on the PLC model. Be sure to set within the range available with the PLC to be used. Use [TYPE] when assigning the indirect memory for macro programs.

Memory	TYPE	Remarks
D (data register)	00H	
W (link register)	01H	
R (file register)	02H	
TN (timer/current value)	03H	
CN (counter/current value)	04H	
SPU (special unit buffer memory)	05H	Invalid on QnU series Built-in port *1
M (internal relay)	06H	
L (latch relay)	07H	
B (link relay)	08H	
X (input)	09H	
Y (output)	0AH	
TS (timer/contact)	0BH	Invalid on QnU series Built-in port
TC (timer/coil)	0CH	Invalid on QnU series Built-in port
CS (counter/contact)	0DH	Invalid on QnU series Built-in port
CC (counter/coil)	0EH	Invalid on QnU series Built-in port
H (link unit buffer memory)	0FH	Invalid on QnU series Built-in port
SD (special register)	10H	
SM (special relay)	11H	
SB (special link relay)	12H	
SW (special link register)	13H	
ZR (file register (for continuous access))	14H	
F (annunciator)	15H	
SS (totalizing timer/contact)	16H	
SC (totalizing timer/coil)	17H	
SN (totalizing timer/current value)	18H	
Z (index register)	19H	

*1 The unit number is required in addition to the memory type and address. Convert byte address into word address when entering the data on the editor if the memory device of the link unit is byte address.
For the unit number, set the decimal number of "XXX" included in the station I/O number "xxx0 H" of the link unit. For more information, see page 26-14.

26.1.7 QnU Series CPU

The communication setting and available memory are the same as those described in "26.1.5 QnH (Q) Series CPU".

26.1.8 Q00J/00/01 CPU

The communication setting and available memory are the same as those described in "26.1.5 QnH (Q) Series CPU".

26.1.9 QnH (Q) Series Link (Multi CPU)

The communication setting and available memory are the same as those described in "26.1.4 QnH (Q) Series Link".

26.1.10 QnH (Q) Series (Multi CPU) (Ethernet)

The communication setting and available memory are the same as those described in "26.1.6 QnH (Q) Series (Ethernet)".

26.1.11 QnH (Q) Series CPU (Multi CPU)

The communication setting and available memory are the same as those described in "26.1.5 QnH (Q) Series CPU".

26.1.12 QnH (Q) Series (Ethernet ASCII)

Communication Setting

Editor

Make the following settings on the editor. For more information, see “Appendix 2 Ethernet”.

- IP address for the TS unit
 - Setting on the V-SFT [IP Address Setting] tab window ([System setting] → [Ethernet Communication] → [Local Port IP Address])
 - Setting on the TS Series [Ethernet] screen on the Main Menu screen.
- Port number for the TS unit (for PLC communication) [Communication Setting] tab window ([System Setting] → [Device Connection Setting])
- Others
 - When connecting to the Ethernet unit on the PLC’s base, check the Batch Readout of Multiple Blocks check box.
 - When connecting to the built-in Ethernet port on the PLC, check the Random Readout check box.
- When connecting to the Ethernet unit on the PLC’s base
- When connecting to the built-in Ethernet port on the PLC

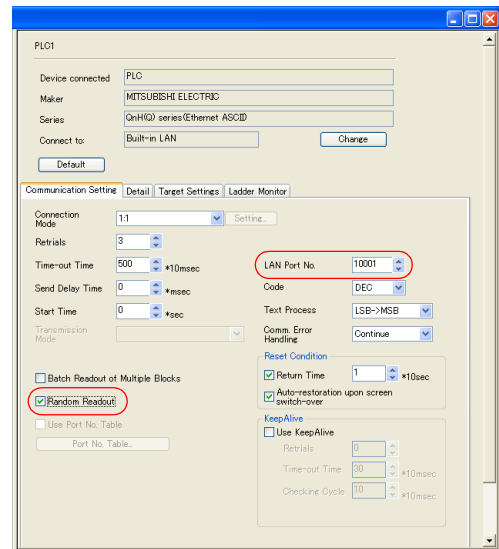
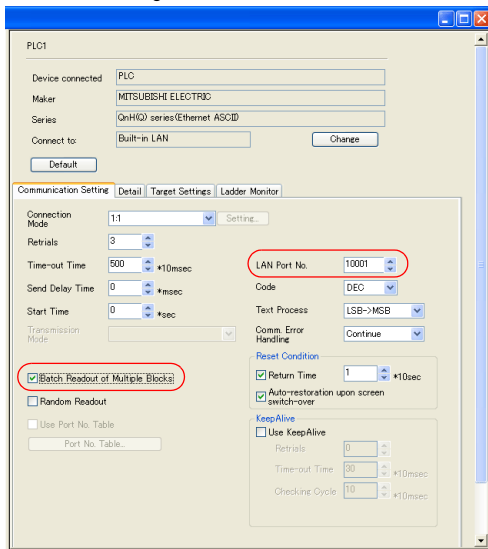

- PLC’s IP address and port number [PLC Table] in the [Target Settings] tab window ([System Setting] → [Device Connection Setting] → [Target Settings])

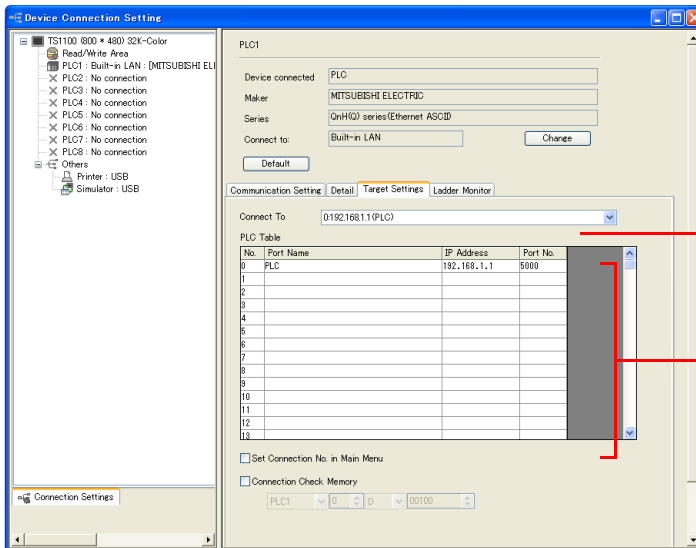

Effective only when 1:1 has been selected

PLC’s IP address and port number

PLC

Make the PLC setting using the programming tool “GX-Developer”. For more information, refer to the PLC manual issued by the manufacturer.

Ethernet unit

PC parameter

Make the I/O assignment setting for the Ethernet unit.

Network parameter (Ethernet)

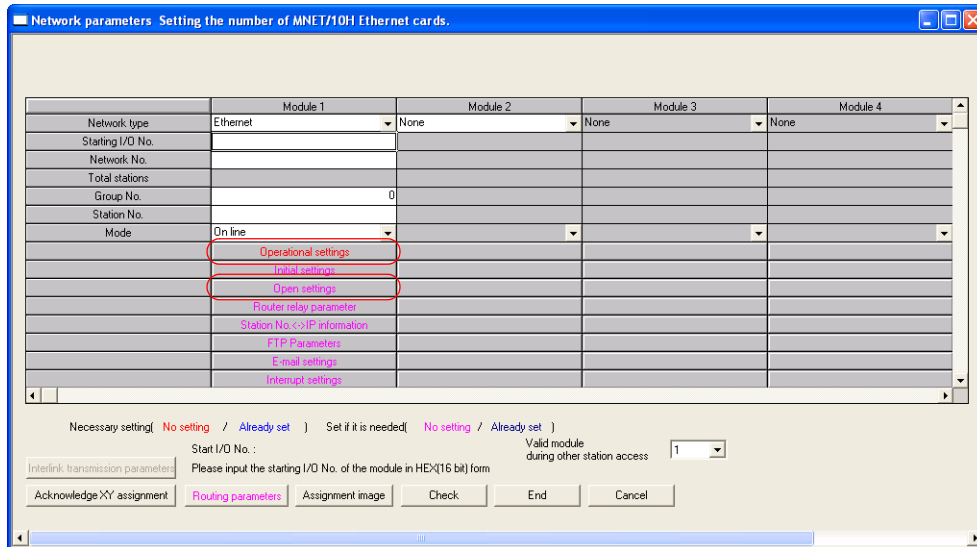

Item	Setting	Remarks
Network type	Ethernet	For more information, refer to the manual of the PLC.
Station I/O No.		
Network No.	Make settings in accordance with the network environment.	
Group No.		
Station No.		

Ethernet operations

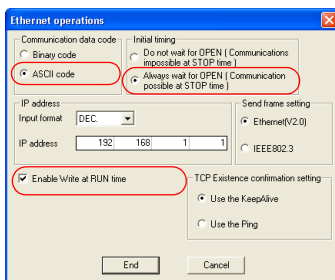

Item	Setting	Remarks
Communication data code	ASCII code	
Initial timing	Always wait for OPEN (Communication possible at STOP time)	
IP address (DEC)	Make settings in accordance with the network environment.	
<input type="checkbox"/> Enable Write at RUN time	Checked	It is not possible to write value from TS to PLC when unchecked. If so, “error code received 7167” occurs.

Open setting

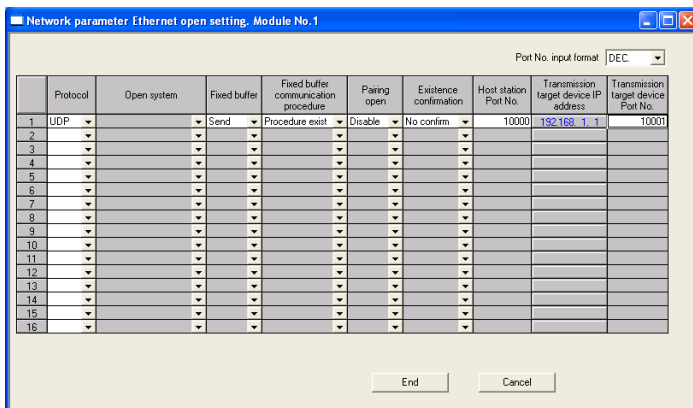

Item	Setting	Remarks
Protocol	UDP	
Host station Port No. (DEC)	Make settings in accordance with the network environment.	It is not possible to set it from No. 5000 to 5002.
Transmission target device IP address (DEC)	IP address of TS	
Transmission target device Port No. (DEC)	Port No. of TS	

Built-in Ethernet port

PC parameter

Make the settings for the IP address and the open settings in the [Built-in Ethernet port] tab window.

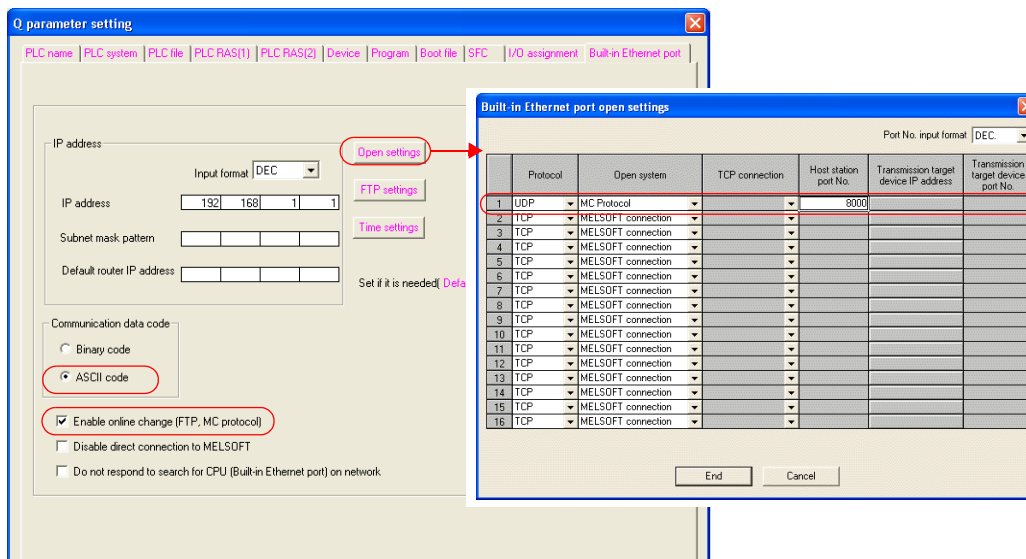

Item	Setting	Remarks
IP address (DEC)	Make settings in accordance with the network environment.	For more information, refer to the manual of the PLC.
Communication data code	ASCII code	
<input type="checkbox"/> Enable online change (FTP, MC protocol)	Checked	It is not possible to write value from TS to PLC when unchecked. If so, "error code received 7167" occurs.
Protocol	UDP	
Open system	MC Protocol	
Host station port No. (DEC)	Make settings in accordance with the network environment.	It is not possible to set it from No. 5000 to 5009.

Available Memory

The available memory setting range varies depending on the PLC model. Be sure to set within the range available with the PLC to be used. Use [TYPE] when assigning the indirect memory for macro programs.

Memory	TYPE	Remarks
D (data register)	00H	
W (link register)	01H	
R (file register)	02H	
TN (timer/current value)	03H	
CN (counter/current value)	04H	
SPU (special unit buffer memory)	05H	Invalid on QnU series Built-in port *1
M (internal relay)	06H	
L (latch relay)	07H	
B (link relay)	08H	
X (input)	09H	
Y (output)	0AH	
TS (timer/contact)	0BH	Invalid on QnU series Built-in port
TC (timer/coil)	0CH	Invalid on QnU series Built-in port
CS (counter/contact)	0DH	Invalid on QnU series Built-in port
CC (counter/coil)	0EH	Invalid on QnU series Built-in port
H (link unit buffer memory)	0FH	Invalid on QnU series Built-in port
SD (special register)	10H	
SM (special relay)	11H	
SB (special link relay)	12H	
SW (special link register)	13H	
ZR (file register (for continuous access))	14H	
F (annunciator)	15H	
SS (totalizing timer/contact)	16H	
SC (totalizing timer/coil)	17H	
SN (totalizing timer/current value)	18H	
Z (index register)	19H	

*1 The unit number is required in addition to the memory type and address. Convert byte address into word address when entering the data on the editor if the memory device of the link unit is byte address.
For the unit number, set the decimal number of "XXX" included in the station I/O number "xxx0 H" of the link unit. For more information, see page 26-14.

26.1.13 QnH (Q) Series (Multi-CPU) (Ethernet ASCII)

The communication setting and available memory are the same as those described in "26.1.12 QnH (Q) Series (Ethernet ASCII)".

26.1.14 QnU Series (Built-in Ethernet)

Communication Setting

Editor

Make the following settings on the editor. For more information, see “Appendix 2 Ethernet”.

- IP address for the TS unit
 - Setting on the V-SFT
[IP Address Setting] tab window ([System setting] → [Ethernet Communication] → [Local Port IP Address])
 - Setting on the TS Series
[Ethernet] screen on the Main Menu screen.
- Port number for the TS unit (for PLC communication)
[Communication Setting] tab window ([System Setting] → [Device Connection Setting])

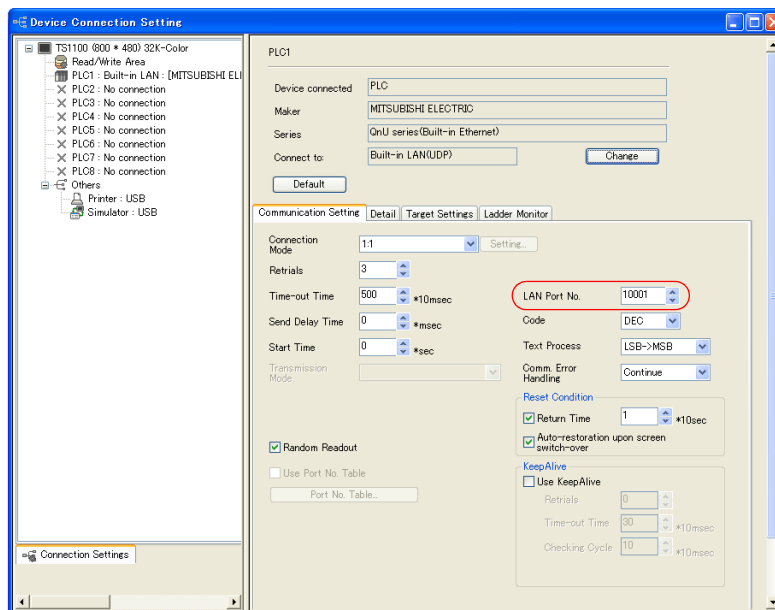

- PLC's IP address and port number
[PLC Table] in the [Target Settings] tab window ([System Setting] → [Device Connection Setting] → [Target Settings])

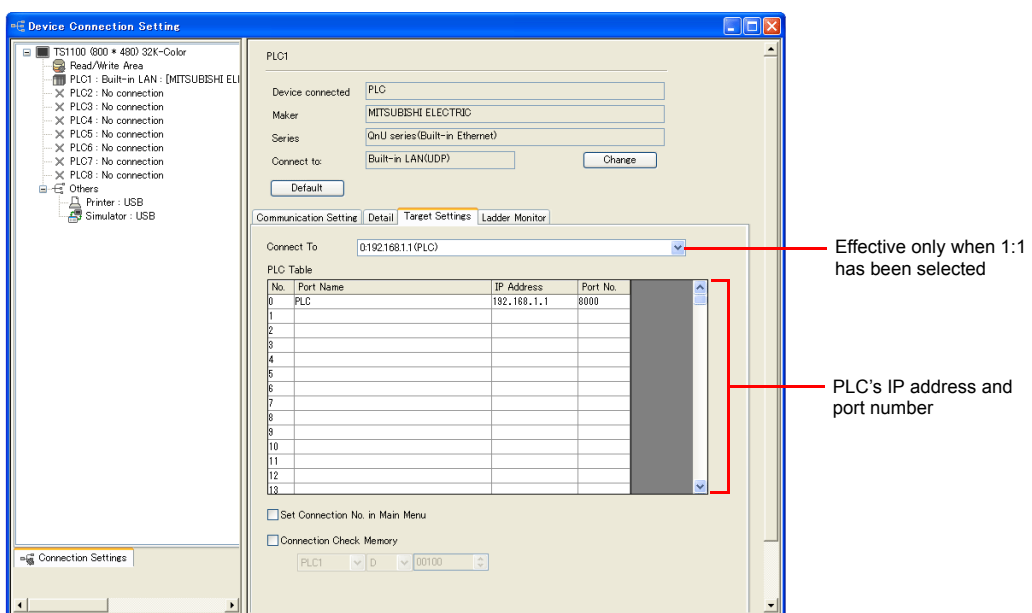

PLC

Make the PLC setting using the programming tool “GX-Developer”. For more information, refer to the PLC manual issued by the manufacturer.

QnU Series Built-in Ethernet

PC parameter

Make the settings for the IP address and the open settings in the Built-in Ethernet port tab window.

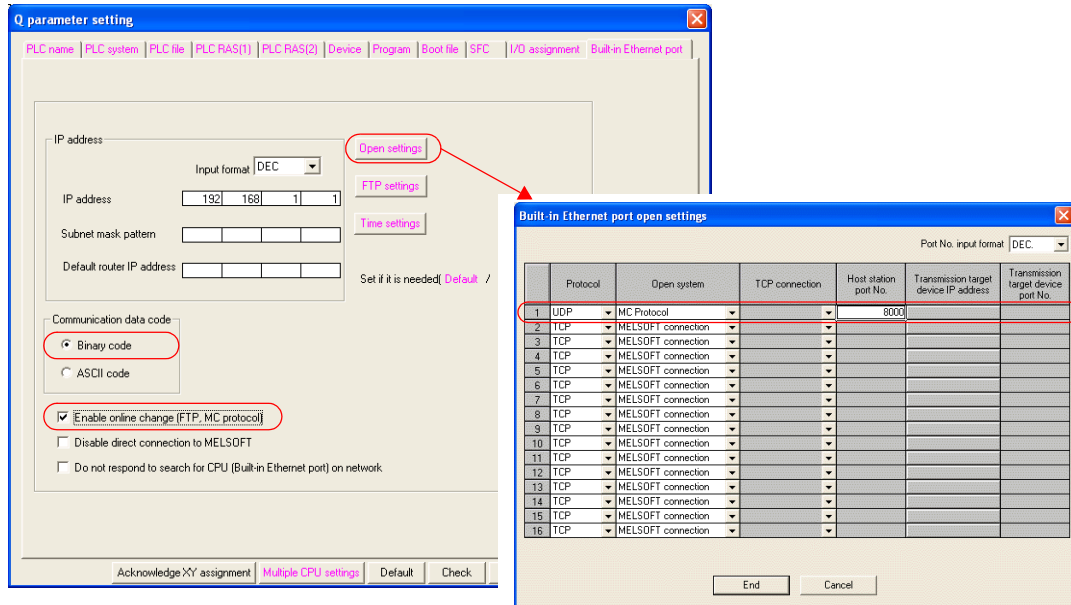

Item	Setting	Remarks
IP address (DEC)	Make settings in accordance with the network environment.	For more information, refer to the manual of the PLC.
Communication data code	Binary code	
<input type="checkbox"/> Enable online change (FTP, MC protocol)	Checked	It is not possible to write value from TS to PLC when unchecked. If so, “error code received 7167” occurs.
Protocol	UDP/TCP	Set the same protocol as the one set on the editor.
Open system	MC Protocol	
Host station port No. (DEC)	Make settings in accordance with the network environment.	It is not possible to set it from No. 5000 to 5009.

Available Memory

The available memory setting range varies depending on the PLC model. Be sure to set within the range available with the PLC to be used. Use [TYPE] when assigning the indirect memory for macro programs.

Memory	TYPE	Remarks
D (data register)	00H	
W (link register)	01H	
R (file register)	02H	
TN (timer/current value)	03H	
CN (counter/current value)	04H	
M (internal relay)	06H	
L (latch relay)	07H	
B (link relay)	08H	
X (input)	09H	
Y (output)	0AH	
TS (timer/contact)	0BH	
TC (timer/coil)	0CH	
CS (counter/contact)	0DH	
CC (counter/coil)	0EH	
SD (special register)	10H	
SM (special relay)	11H	
SB (special link relay)	12H	
SW (special link register)	13H	
ZR (file register (for continuous access))	14H	
F (annunciator)	15H	
SS (totalizing timer/contact)	16H	
SC (totalizing timer/coil)	17H	
SN (totalizing timer/current value)	18H	
Z (index register)	19H	

26.1.15 L Series Link

Communication Setting

Editor

Communication setting

(Underlined setting: default)

Item	Setting	Remarks
Connection Mode	<u>1</u> : 1 / 1 : n / Multi-link2 / Multi-link2 (Ethernet)	
Signal Level	<u>RS-232C</u> / RS-422/485	
Baud Rate	4800 / 9600 / 19200 / 38400 / 57600 / <u>115K</u> bps	
Data Length	8 bits	
Stop Bit	<u>1</u> / 2 bits	
Parity	None / Odd / <u>Even</u>	
Target Port No.	<u>0</u> to 31	

PLC (PC Parameter)

Switch setting for I/O and intelligent function module

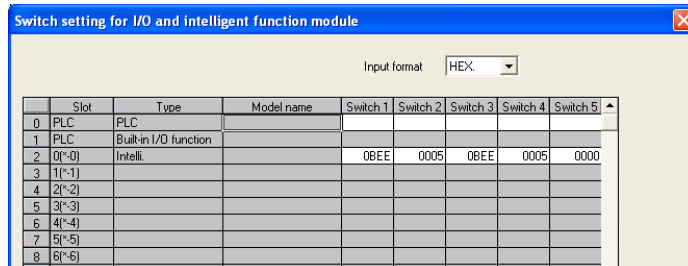

Switch	Contents	Example																																																		
Switch 1	<p>CH1: baud rate, transmission setting</p> <p>Bit 15 - 8 7 - 0</p> <p>Baud rate Transmission setting</p> <table border="1"> <thead> <tr> <th>bps</th> <th>Setting</th> </tr> </thead> <tbody> <tr> <td>4800</td> <td>04H</td> </tr> <tr> <td>9600</td> <td>05H</td> </tr> <tr> <td>19200</td> <td>07H</td> </tr> <tr> <td>38400</td> <td>09H</td> </tr> <tr> <td>57600</td> <td>0AH</td> </tr> <tr> <td>115200</td> <td>0BH</td> </tr> </tbody> </table> <table border="1"> <thead> <tr> <th>Bit</th> <th>Contents</th> <th>OFF</th> <th>ON</th> </tr> </thead> <tbody> <tr> <td>0</td> <td>Operation</td> <td>Independent</td> <td>Link</td> </tr> <tr> <td>1</td> <td>Data bit</td> <td>7</td> <td>8</td> </tr> <tr> <td>2</td> <td>Parity bit</td> <td>Not provided</td> <td>Provided</td> </tr> <tr> <td>3</td> <td>Parity</td> <td>Odd</td> <td>Even</td> </tr> <tr> <td>4</td> <td>Stop bit</td> <td>1</td> <td>2</td> </tr> <tr> <td>5</td> <td>Sum check</td> <td>Not provided</td> <td>Provided</td> </tr> <tr> <td>6</td> <td>Write while running</td> <td>Prohibited</td> <td>Allowed</td> </tr> <tr> <td>7</td> <td>Setting change</td> <td>Prohibited</td> <td>Allowed</td> </tr> </tbody> </table>	bps	Setting	4800	04H	9600	05H	19200	07H	38400	09H	57600	0AH	115200	0BH	Bit	Contents	OFF	ON	0	Operation	Independent	Link	1	Data bit	7	8	2	Parity bit	Not provided	Provided	3	Parity	Odd	Even	4	Stop bit	1	2	5	Sum check	Not provided	Provided	6	Write while running	Prohibited	Allowed	7	Setting change	Prohibited	Allowed	<p>0BEEH</p> <p>115 kbps 8 bits 1 bit Even</p>
bps	Setting																																																			
4800	04H																																																			
9600	05H																																																			
19200	07H																																																			
38400	09H																																																			
57600	0AH																																																			
115200	0BH																																																			
Bit	Contents	OFF	ON																																																	
0	Operation	Independent	Link																																																	
1	Data bit	7	8																																																	
2	Parity bit	Not provided	Provided																																																	
3	Parity	Odd	Even																																																	
4	Stop bit	1	2																																																	
5	Sum check	Not provided	Provided																																																	
6	Write while running	Prohibited	Allowed																																																	
7	Setting change	Prohibited	Allowed																																																	
Switch 2	CH1: communication protocol	MC protocol mode 5 binary code	0005H																																																	
Switch 3	CH2: baud rate, transmission setting (the same as those for switch 1)		0BEEH																																																	
Switch 4	CH2: communication protocol	MC protocol mode 5 binary code	0005H																																																	
Switch 5	Station number setting	0 to 31	0000H																																																	

Available Memory

The available memory setting range varies depending on the PLC model. Be sure to set within the range available with the PLC to be used. Use [TYPE] when assigning the indirect memory for macro programs.

Memory	TYPE	Remarks
D (data register)	00H	
W (link register)	01H	
R (file register)	02H	
TN (timer/current value)	03H	
CN (counter/current value)	04H	
M (internal relay)	06H	
L (latch relay)	07H	
B (link relay)	08H	
X (input)	09H	
Y (output)	0AH	
TS (timer/contact)	0BH	
TC (timer/coil)	0CH	
CS (counter/contact)	0DH	
CC (counter/coil)	0EH	
H (link unit buffer memory)	0FH	
SD (special register)	10H	
SM (special relay)	11H	
SB (special link relay)	12H	
SW (special link register)	13H	
ZR (file register (for continuous access))	14H	
F (annunciator)	15H	
SS (totalizing timer/contact)	16H	
SC (totalizing timer/coil)	17H	
SN (totalizing timer/current value)	18H	
Z (index register)	19H	

26.1.16 L Series (Built-in Ethernet)

Communication Setting

Editor

Make the following settings on the editor. For more information, see “Appendix 2 Ethernet”.

- IP address for the TS unit
 - Setting on the V-SFT
[IP Address Setting] tab window ([System setting] → [Ethernet Communication] → [Local Port IP Address])
 - Setting on the TS Series
[Ethernet] screen on the Main Menu screen.
- Port number for the TS unit (for PLC communication)
[Communication Setting] tab window ([System Setting] → [Device Connection Setting])

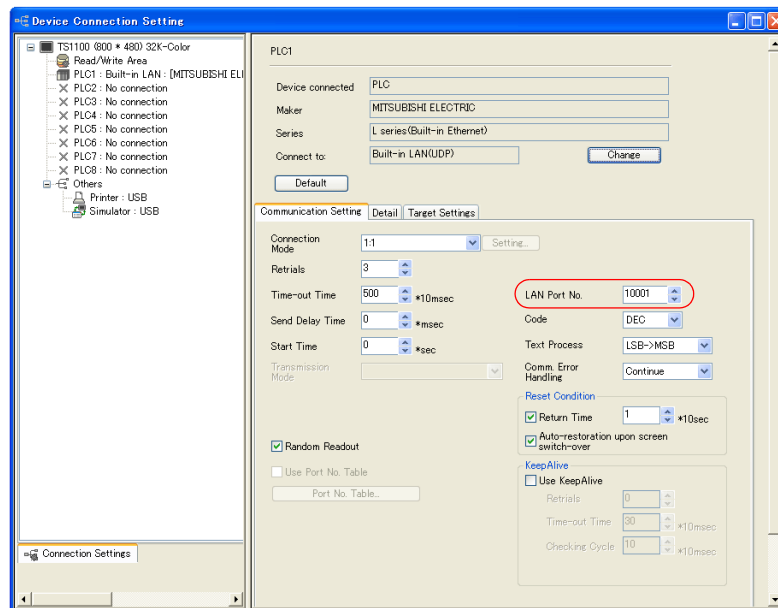

- PLC's IP address and port number
[PLC Table] in the [Target Settings] tab window ([System Setting] → [Device Connection Setting] → [Target Settings])

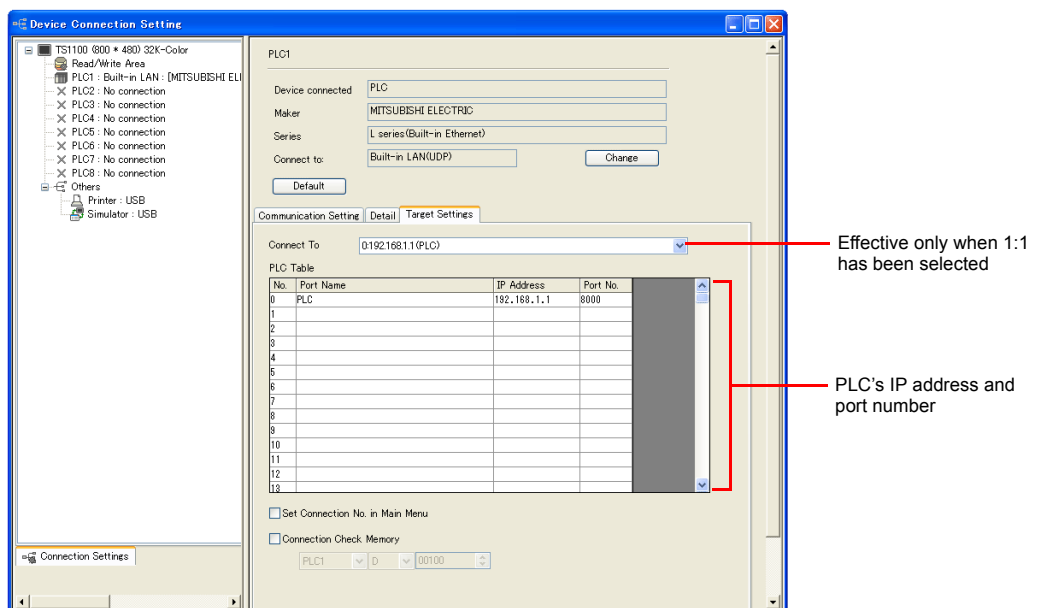

PLC

Make the PLC setting using the programming tool “GX-Developer”. For more information, refer to the PLC manual issued by the manufacturer.

L Series Built-in Ethernet

Make the settings for the IP address and the open settings in the Built-in Ethernet port tab window.

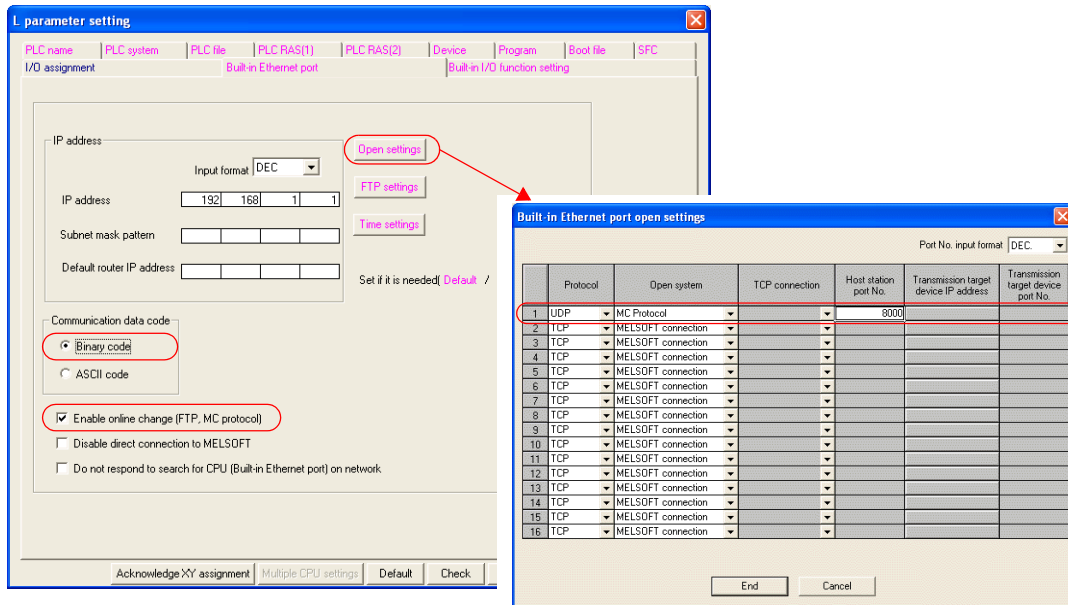

Item	Setting	Remarks
IP address (DEC)	Make settings in accordance with the network environment.	For more information, refer to the manual of the PLC.
Communication data code	Binary code	
<input type="checkbox"/> Enable online change (FTP, MC protocol)	Checked	It is not possible to write value from TS to PLC when unchecked. If so, "error code received 7167" occurs.
Protocol	UDP/TCP	Set the same protocol as the one set on the editor.
Open system	MC Protocol	
Host station port No. (DEC)	Make settings in accordance with the network environment.	It is not possible to set it from No.5000 to 5009.

Available Memory

The available memory setting range varies depending on the PLC model. Be sure to set within the range available with the PLC to be used. Use [TYPE] when assigning the indirect memory for macro programs.

Memory	TYPE	Remarks
D (data register)	00H	
W (link register)	01H	
R (file register)	02H	
TN (timer/current value)	03H	
CN (counter/current value)	04H	
M (internal relay)	06H	
L (latch relay)	07H	
B (link relay)	08H	
X (input)	09H	
Y (output)	0AH	
TS (timer/contact)	0BH	
TC (timer/coil)	0CH	
CS (counter/contact)	0DH	
CC (counter/coil)	0EH	
SD (special register)	10H	
SM (special relay)	11H	
SB (special link relay)	12H	
SW (special link register)	13H	
ZR (file register (for continuous access))	14H	
F (annunciator)	15H	
SS (totalizing timer/contact)	16H	
SC (totalizing timer/coil)	17H	
SN (totalizing timer/current value)	18H	
Z (index register)	19H	

26.1.17 FX2N/1N Series CPU

Communication Setting

Editor

Communication setting

(Underlined setting: default)

Item	Setting	Remarks
Connection Mode	<u>1:1</u> / Multi-link2	
Signal Level	RS-422/485	
Baud Rate	9600 / 19200 / <u>38400</u> bps	
Data Length	7 bits	
Stop Bit	1 bit	
Parity	Even	
Target Port No.	<u>0</u> to 31	

PLC

No particular setting is necessary on the PLC.

Available Memory

The available memory setting range varies depending on the PLC model. Be sure to set within the range available with the PLC to be used. Use [TYPE] when assigning the indirect memory for macro programs.

Memory	TYPE	Remarks
D (data register)	00H	D8000 and later: special register
TN (timer/current value)	01H	
CN (counter/current value)	02H	
32CN (32-bit counter/current value)	03H	*1
M (auxiliary relay)	04H	M8000 and later: special relay
S (state)	05H	
X (input relay)	06H	Read only
Y (output relay)	07H	
TS (timer/contact)	08H	
CS (counter/contact)	09H	

*1 For items where double-words can be used (Num. Display, Graph, Sampling), data is processed as double-words.
 For those where bits or words can be used, data is processed as words consisting of lower 16 bits.
 For input: Upper 16 bits are ignored.
 For output: "0" is written for upper 16 bits.

26.1.18 FX1S Series CPU

Communication Setting

Editor

Communication setting

(Underlined setting: default)

Item	Setting	Remarks
Connection Mode	<u>1:1</u> / Multi-link2	
Signal Level	RS-422/485	
Baud Rate	9600 bps	
Data Length	7 bits	
Stop Bit	1 bit	
Parity	Even	
Target Port No.	<u>0</u> to 31	

PLC

No particular setting is necessary on the PLC.

Available Memory

The available memory setting range varies depending on the PLC model. Be sure to set within the range available with the PLC to be used. Use [TYPE] when assigning the indirect memory for macro programs.

Memory	TYPE	Remarks
D (data register)	00H	D0 to 255, D8000 or later (special register)
TN (timer/current value)	01H	
CN (counter/current value)	02H	
32CN (32-bit counter/current value)	03H	Double word *1
M (auxiliary relay)	04H	M0 to 511, M8000 or later (special relay)
S (state)	05H	
X (input relay)	06H	Read only
Y (output relay)	07H	
TS (timer/contact)	08H	
CS (counter/contact)	09H	
DX (file register)	0AH	Use DX for D1000 to 2999.

*1 For items where double-words can be used (Num. Display, Graph, Sampling), data is processed as double-words.
 For those where bits or words can be used, data is processed as words consisting of lower 16 bits.
 For input: Upper 16 bits are ignored.
 For output: "0" is written for upper 16 bits.

26.1.19 FX Series Link (A Protocol)

Communication Setting

Editor

Communication setting

(Underlined setting: default)

Item	Setting	Remarks
Connection Mode	<u>1</u> : 1 / 1 : n / Multi-link / Multi-link2	
Signal Level	<u>RS-232C</u> / RS-422/485	
Baud Rate	4800 / 9600 / <u>19200</u> bps	
Transmission Mode	<u>Transmission Mode 1</u> / Transmission Mode 4	
Data Length	<u>7</u> / 8 bits	
Stop Bit	<u>1</u> / 2 bits	
Parity	None / Odd / <u>Even</u>	
Target Port No.	<u>0</u> to 31	

PLC (PC Parameter)

PLC system (2)

Item	Setting	Remarks
<input type="checkbox"/> Operate communication setting	Checked	
Protocol	Dedicated protocol	
Data length	<u>7</u> bits / 8 bits	<ul style="list-style-type: none"> RS-232C When you set Dedicated protocol, 7bits, Even, 1bit, 19200bps, sum check and form 1: D8120 = 6896H
Parity	None / <u>Odd</u> / Even	
Stop bit	<u>1</u> bit / 2 bits	<ul style="list-style-type: none"> RS-422 When you set Dedicated protocol, 7bits, Even, 1bit, 19200bps, sum check and form 1: D8120 = 6096H
Transmission speed	4800 / <u>9600</u> / 19200 bps	
H/W type	<u>RS-232C</u> / RS-485	
<input type="checkbox"/> Sum check	Checked	
Transmission control protocol	<u>Form 1</u> / Form 4	
Station number setting	<u>00</u> to 0FH	

Available Memory

The available memory setting range varies depending on the PLC model. Be sure to set within the range available with the PLC to be used. Use [TYPE] when assigning the indirect memory for macro programs.

Memory	TYPE	Remarks
D (data register)	00H	D8000 and later: special register
TN (timer/current value)	01H	
CN (counter/current value)	02H	*1
32CN (32-bit counter/current value)	03H	*2
M (auxiliary relay)	04H	M8000 and later: special relay
S (state)	05H	
X (input relay)	06H	Read only
Y (output relay)	07H	
TS (timer/contact)	08H	
CS (counter/contact)	09H	

*1 CN200 to CN255 equals 32CN (32-bit counter).

*2 For items where double-words can be used (Num. Display, Graph, Sampling), data is processed as double-words.
For those where bits or words can be used, data is processed as words consisting of lower 16 bits.

For input: Upper 16 bits are ignored.

For output: "0" is written for upper 16 bits.

26.1.20 FX-3U/3UC/3G Series CPU

Communication Setting

Editor

Communication setting

(Underlined setting: default)

Item	Setting	Remarks
Connection Mode	<u>1:1</u> / Multi-link2	
Signal Level	RS-422/485	
Baud Rate	9600 / 19200 / 38400 / 57600 / <u>115K</u> bps	
Data Length	7 bits	
Stop Bit	1 bit	
Parity	Even	

PLC

No particular setting is necessary on the PLC.

Available Memory

The available memory setting range varies depending on the PLC model. Be sure to set within the range available with the PLC to be used. Use [TYPE] when assigning the indirect memory for macro programs.

Memory	TYPE	Remarks
D (data register)	00H	D8000 and later: special register
TN (timer/current value)	01H	
CN (counter/current value)	02H	
32CN (32-bit counter/current value)	03H	*1
M (auxiliary relay)	04H	M8000 and later: special relay
S (state)	05H	
X (input relay)	06H	Read only
Y (output relay)	07H	
TS (timer/contact)	08H	
CS (counter/contact)	09H	
R (extension register)	0BH	

- *1 For items where double-words can be used (Num. Display, Graph, Sampling), data is processed as double-words.
 For those where bits or words can be used, data is processed as words consisting of lower 16 bits.
 For input Upper 16 bits are ignored.
 For output "0" is written for upper 16 bits.

26.1.21 FX-3U Series (Ethernet)

Communication Setting

Editor

Make the following settings on the editor. For more information, see “Appendix 2 Ethernet”.

- IP address for the TS unit
 - Setting on the V-SFT
 - [IP Address Setting] tab window ([System setting] → [Ethernet Communication] → [Local Port IP Address])
 - Setting on the TS Series [Ethernet] screen on the Main Menu screen.
- Port number for the TS unit (for PLC communication)
 - [Communication Setting] tab window ([System Setting] → [Device Connection Setting])

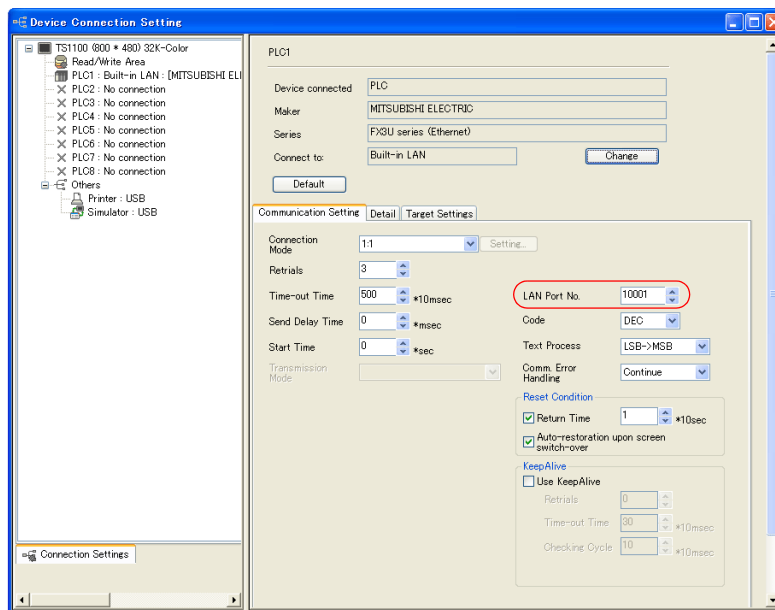

- PLC's IP address and port number
 - [PLC Table] in the [Target Settings] tab window ([System Setting] → [Device Connection Setting])

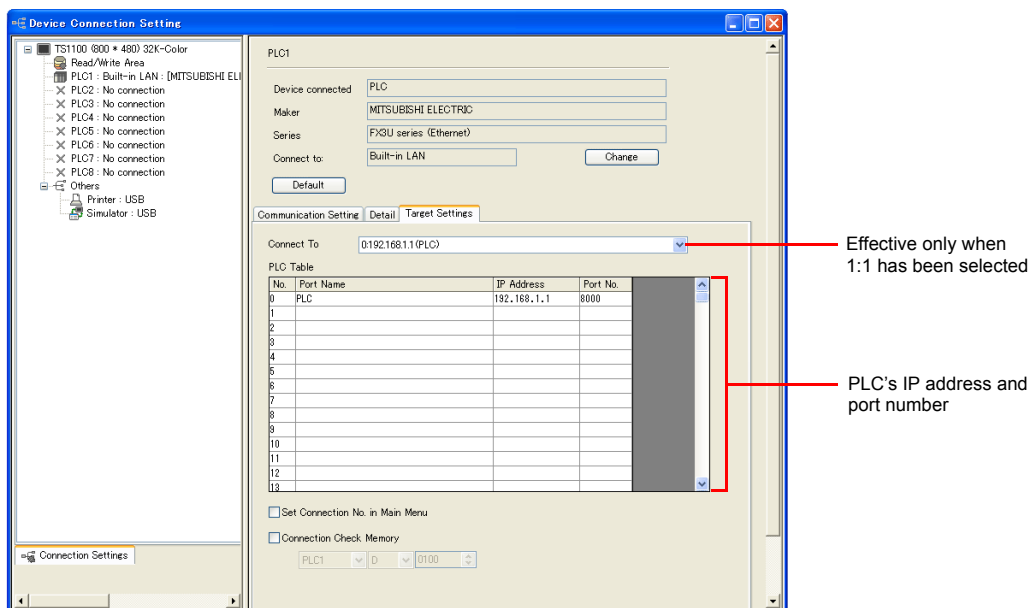

PLC

FX3U-ENET-L

Make PLC settings using the configuration tool "FX3U-ENET-L".

Ethernet operational settings

Item	Setting	Remarks
Communication data code	Binary code	
Initial timing	Always wait for OPEN (Communication possible at STOP time)	
IP address (DEC)	Specify according to the environment.	

Ethernet open settings

Use row No. 3 or No. 4 for setting.

Item	Setting	Remarks
Protocol	UDP	
Open system	MC protocol	
Existence confirmation	No confirm	
Host station Port No. (DEC)	As desired	1025 to 5548, 5552 to 65534
Transmission target device IP address	IP address of the TS	
Transmission target device Port No. (DEC)	Port number of the TS	

FX3U-ENET

Make the PLC setting using the programming tool "FX-Configurator-EN". For more information, refer to the PLC manual issued by the manufacturer.

Ethernet operational settings

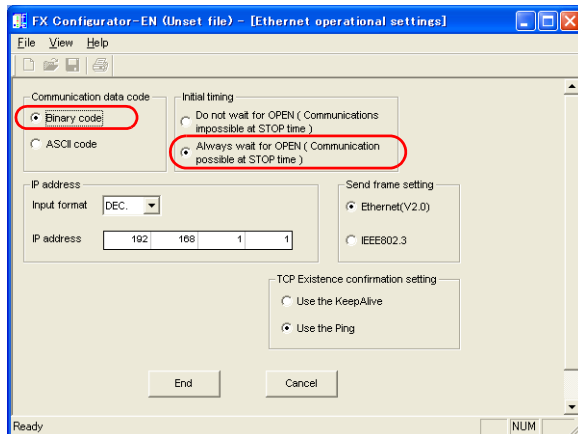

Item	Setting	Remarks
Communication data code	Binary code	
Initial timing	Always wait for OPEN (Communication possible at STOP time)	
IP address (DEC)	Make settings in accordance with the network environment.	

Open setting

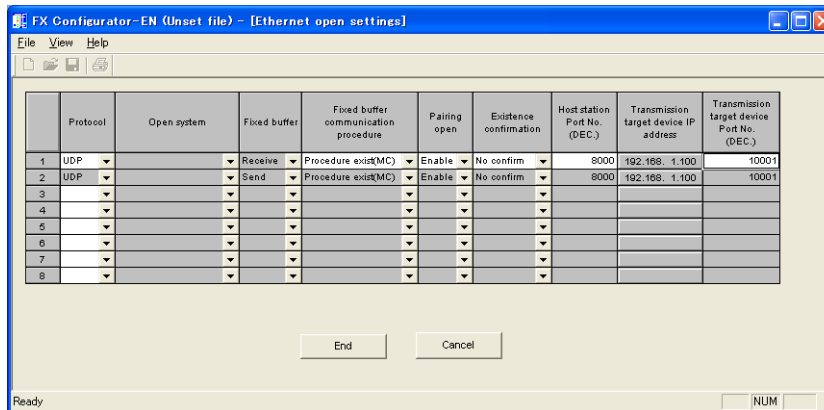

Item	Setting	Remarks
Protocol	UDP	
Fixed buffer	Receive, Send	
Fixed buffer communication procedure	Procedure exist (MC)	
Pairing open	Enable	
Existence confirmation	No confirm	
Host station Port No. (DEC)	Make settings in accordance with the network environment.	1025 to 5548, 5552 to 65534
Transmission target device IP address (DEC)	IP address of TS	
Transmission target device Port No. (DEC)	Port No. of TS	

Available Memory

The available memory setting range varies depending on the PLC model. Be sure to set within the range available with the PLC to be used. Use [TYPE] when assigning the indirect memory for macro programs.

Memory	TYPE	Remarks
D (data register)	00H	D8000 and later: special register
TN (timer/current value)	01H	
CN (counter/current value)	02H	
32CN (32-bit counter/current value)	03H	*1
M (auxiliary relay)	04H	M8000 and later: special relay
S (state)	05H	
X (input relay)	06H	Read only
Y (output relay)	07H	
TS (timer/contact)	08H	
CS (counter/contact)	09H	
R (extension register)	0BH	

- *1 For items where double-words can be used (Num. Display, Graph, Sampling), data is processed as double-words. For those where bits or words can be used, data is processed as words consisting of lower 16 bits.
 For input Upper 16 bits are ignored.
 For output "0" is written for upper 16 bits.

26.1.22 FX3U/3UC/3G Series Link (A Protocol)

Communication Setting

Editor

Communication setting

(Underlined setting: default)

Item	Setting	Remarks
Connection Mode	<u>1</u> : 1 / 1 : n / Multi-link / Multi-link2	
Signal Level	<u>RS-232C</u> / RS-422/485	
Baud Rate	4800 / 9600 / <u>19200</u> bps	
Transmission Mode	<u>Transmission Mode 1</u> / Transmission Mode 4	
Data Length	<u>7</u> / 8 bits	
Stop Bit	<u>1</u> / 2 bits	
Parity	None / Odd / <u>Even</u>	
Target Port No.	<u>0</u> to 31	

PLC (PC Parameter)

PLC system (2)

Item	Setting	Remarks
<input type="checkbox"/> Operate communication setting	Checked	
Protocol	Dedicated protocol	<ul style="list-style-type: none"> RS-232C When you set Dedicated protocol, 7bits, Even, 1bit, 19200bps, sum check and form 1: D8120 (D8420) = 6896H RS-422 When you set Dedicated protocol, 7bits, Even, 1bit, 19200bps, smacked and form 1: D8120 (D8420) = 6096H
Data length	<u>7</u> bits / 8 bits	
Parity	None / <u>Odd</u> / Even	
Stop bit	<u>1</u> bit / 2 bits	
Transmission speed	4800 / <u>9600</u> / 19200 bps	
H/W type	<u>RS-232C</u> / RS-485	
<input type="checkbox"/> Sum check	Checked	
Transmission control protocol	<u>Form 1</u> / Form 4	* CH1 : D8120, CH2 : D8420
Station number setting	<u>00</u> to 0FH	

Available Memory

The available memory setting range varies depending on the PLC model. Be sure to set within the range available with the PLC to be used. Use [TYPE] when assigning the indirect memory for macro programs.

Memory	TYPE	Remarks
D (data register)	00H	D8000 and later: special register
TN (timer/current value)	01H	
CN (counter/current value)	02H	
32CN (32-bit counter/current value)	03H	*1
M (auxiliary relay)	04H	M8000 and later: special relay
S (state)	05H	
X (input relay)	06H	Read only
Y (output relay)	07H	
TS (timer/contact)	08H	
CS (counter/contact)	09H	
R (extension register)	0BH	

*1 For items where double-words can be used (Num. Display, Graph, Sampling), data is processed as double-words.
 For those where bits or words can be used, data is processed as words consisting of lower 16 bits.
 For input: Upper 16 bits are ignored.
 For output: "0" is written for upper 16 bits.

26.1.23 Q170MCPU (Multi CPU)

Editor

Communication setting

(Underlined setting: default)

Item	Setting	Remarks
Connection Mode	<u>1 : 1</u> / Multi-link2 / Multi-link2 (Ethernet)	
Signal Level	RS-232C	
Baud Rate	9600 / 19200 / 38400 / 57600 / <u>115K</u> bps	
Data Length	8 bits	
Stop Bit	1 bit	
Parity	Odd	

PLC

When using the PLC for the first time, the operating system must be installed. For more information, refer to the PLC manual issued by the manufacturer.

No communication setting is required.

Available Memory

The available memory setting range varies depending on the PLC model. Be sure to set within the range available for the PLC. Use [TYPE] when assigning the indirect memory for macro programs.

Memory	TYPE	Remarks
D (data register)	00H	
W (link register)	01H	
R (file register)	02H	Available only for the sequencer CPU
TN (timer/current value)	03H	Available only for the sequencer CPU
CN (counter/current value)	04H	Available only for the sequencer CPU
SPU (special unit buffer memory)	05H	Available only for the sequencer CPU *1
M (internal relay)	06H	
L (latch relay)	07H	Available only for the sequencer CPU
B (link relay)	08H	
X (input)	09H	
Y (output)	0AH	
TS (timer/contact)	0BH	Available only for the sequencer CPU
TC (timer/coil)	0CH	Available only for the sequencer CPU
CS (counter/contact)	0DH	Available only for the sequencer CPU
CC (counter/coil)	0EH	Available only for the sequencer CPU
SD (special register)	10H	
SM (special relay)	11H	
SB (special link relay)	12H	Available only for the sequencer CPU
SW (special link register)	13H	Available only for the sequencer CPU
ZR (file register/for continuous access)	14H	Available only for the sequencer CPU
F (annunciator)	15H	
SS (totalizing timer/contact)	16H	Available only for the sequencer CPU
SC (totalizing timer/coil)	17H	Available only for the sequencer CPU
SN (totalizing timer/current value)	18H	Available only for the sequencer CPU
Z (index register)	19H	Available only for the sequencer CPU
# (motion register)	1AH	Available only for the motion CPU

*1 The unit number is required in addition to the memory type and address. To set the memory address on the editor for the link unit which has byte-addressable memory, convert the address into word address. For the unit number, set the decimal number of "XXX" included in the station I/O number "xxx0 H" of the link unit. For more information, see page 26-14.

Specifying the access CPU

In addition to the memory type and address, an access CPU must be specified. The assigned memory is expressed as shown below when editing the screen.

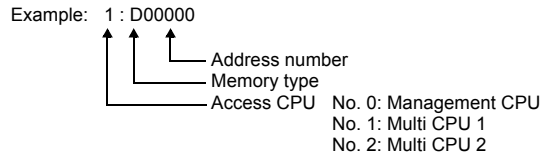

* Q170MCP is equipped with the sequencer CPU and motion CPU in one unit.

The multi CPU unit No. is fixed as shown below:

Management CPU: Sequencer CPU
Multi CPU 1: Sequencer CPU
Multi CPU 2: Motion CPU

Indirect Memory Designation

- For the address number of 0 to 65535:

	15	8	7	0
n + 0	Model		Memory type	
n + 1	Address No.			
n + 2	Expansion code *		Bit designation	
n + 3	00		Station number	

- For the address number of 65536 or greater:

	15	8	7	0
n + 0	Model		Memory type	
n + 1	Lower address No.			
n + 2	Higher address No.			
n + 3	Expansion code *		Bit designation	
n + 4	00		Station number	

- * For the SPU device, specify the unit number in the expansion code.
For any other devices, specify the access CPU number in the expansion code.
Management CPU: 0 Multi CPU: 1 or 2

26.1.24 Q170 Series (Multi CPU) (Ethernet)

Communication Setting

Editor

Make the following settings on the editor. For more information, see Appendix 2 Ethernet.

- IP address for the TS unit
 - When specified on the screen data:
[System Setting] → [Ethernet Communication] → [Local Port IP Address]
 - When specified on the TS unit:
Main Menu screen → [Ethernet]
- Port number for the TS unit (for communication with PLC)
[System Setting] → [Device Connection Setting] → [Communication Setting]

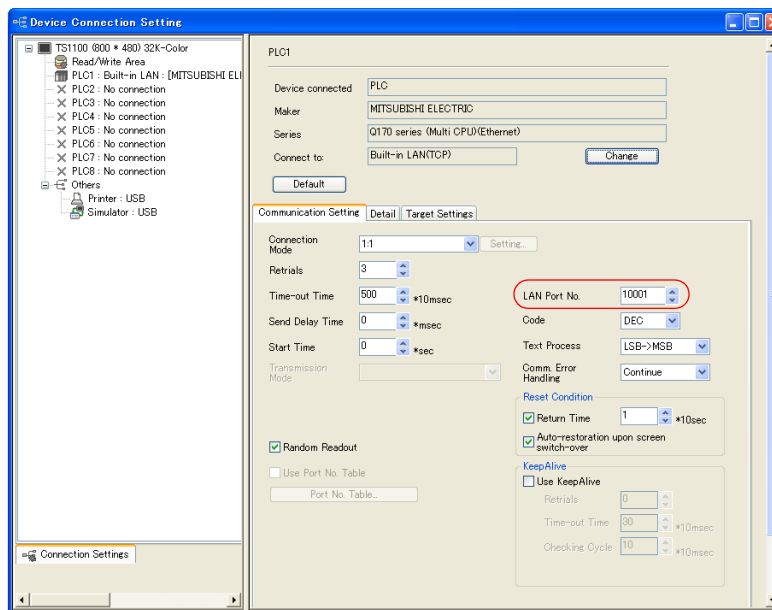

- IP address and port number of the PLC
[System Setting] → [Device Connection Setting] → [PLC Table]

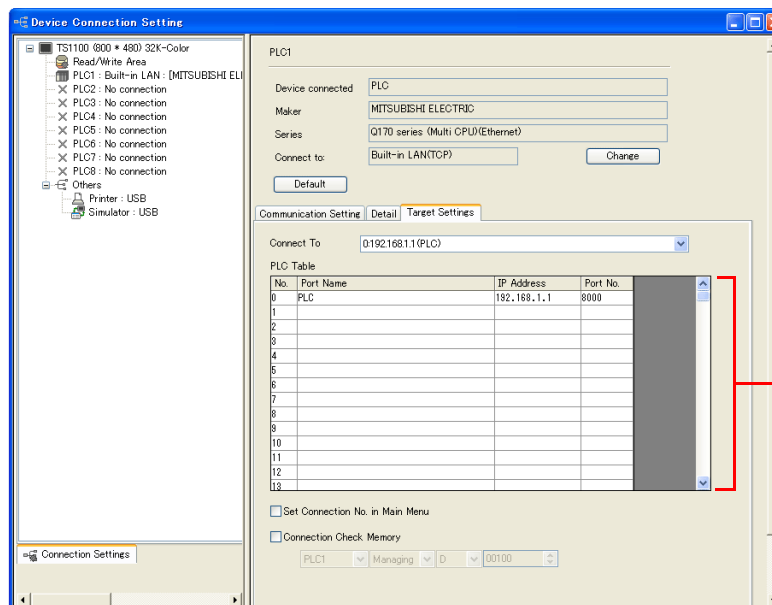

IP address and port number of the PLC (DEC)

On the MT Developer 2, the port number is specified in hexadecimal notation. When specifying the port number on the editor, convert it into the decimal number.

PLC

When using the PLC for the first time, the operating system must be installed.

Make communication settings using the programming tool "MT-Developer2". For more information, refer to the PLC manual issued by the manufacturer.

Built-in Ethernet port setting

Specify the IP address and open method on the built-in Ethernet port setting dialog.

Item	Setting	Remarks
IP address (DEC)	Specify according to the environment.	For more information, refer to the manual of the PLC.
Communication data code	Binary code	
<input type="checkbox"/> Enable writing during running	Checked	Data can be written from TS to PLC only when this box is checked. If writing of data is attempted while the box is unchecked, the error "Error code received Receive code 7167" will occur.
Protocol	UDP/TCP	Set the same protocol as the one set on the editor.
Open type	MC protocol	
Local port No. (HEX)	Specify according to the environment.	1388H to 1391H cannot be specified because they are occupied by the system. When making a setting on the editor, convert the number specified here into a decimal number.

Calendar

Normally the calendar of the sequencer CPU, which is specified in the read or write area, is used.

However, if different numbers are specified in the read area and the write area, the calendar of the CPU specified in the read area is used.

If any device other than the sequencer CPU is specified in the read area and write area, the calendar of the smallest-numbered sequencer CPU is used.

Available Memory

The available memory setting range varies depending on the PLC model. Be sure to set within the range available for the PLC. Use [TYPE] when assigning the indirect memory for macro programs.

Memory	TYPE	Remarks
D (data register)	00H	
W (link register)	01H	
R (file register)	02H	Available only for the sequencer CPU
TN (timer/current value)	03H	Available only for the sequencer CPU
CN (counter/current value)	04H	Available only for the sequencer CPU
M (internal relay)	06H	
L (latch relay)	07H	Available only for the sequencer CPU
B (link relay)	08H	
X (input)	09H	
Y (output)	0AH	
TS (timer/contact)	0BH	Available only for the sequencer CPU
TC (timer/coil)	0CH	Available only for the sequencer CPU
CS (counter/contact)	0DH	Available only for the sequencer CPU
CC (counter/coil)	0EH	Available only for the sequencer CPU
SD (special register)	10H	
SM (special relay)	11H	
SB (special link relay)	12H	Available only for the sequencer CPU
SW (special link register)	13H	Available only for the sequencer CPU
ZR (file register/for continuous access)	14H	Available only for the sequencer CPU
F (annunciator)	15H	
SS (totalizing timer/contact)	16H	Available only for the sequencer CPU
SC (totalizing timer/coil)	17H	Available only for the sequencer CPU
SN (totalizing timer/current value)	18H	Available only for the sequencer CPU
Z (index register)	19H	Available only for the sequencer CPU
# (motion register)	2AH	Available only for the motion CPU

Specifying the access CPU

In addition to the memory type and address, an access CPU must be specified. The assigned memory is expressed as shown below when editing the screen.

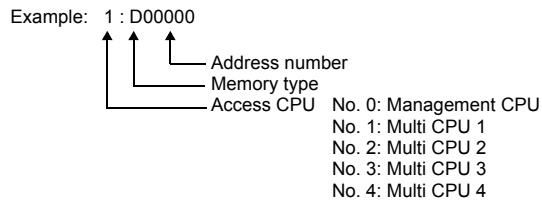

* The multi CPU unit numbers are assigned as shown below:

- For Q170MCPU

Management CPU: Motion CPU
 Multi CPU 1: Sequencer CPU
 Multi CPU 2: Motion CPU

- For Q172DCPU-S1/Q173DCPU-S1

Management CPU: Motion CPU
 Multi CPU 1 to 4: Determined according to the slot position of the CPU

Indirect Memory Designation

- For the address number of 0 to 65535:

	15	8	7	0
n + 0	Model		Memory type	
n + 1	Address No.			
n + 2	Expansion code *		Bit designation	
n + 3	00		Station number	

- For the address number of 65536 or greater:

	15	8	7	0
n + 0	Model		Memory type	
n + 1	Lower address No.			
n + 2	Higher address No.			
n + 3	Expansion code *		Bit designation	
n + 4	00		Station number	

* Specify the access CPU number in the expansion code.
 Management CPU: 0 Multi CPU: 1 or 4

26.1.25 Wiring Diagrams

When Connected at COM1:

RS-422

Wiring diagram 1 - COM1

Hakko Electronics' cable "D9-MI4-0T-□M" (□ = 2, 3, 5, 10, 15)

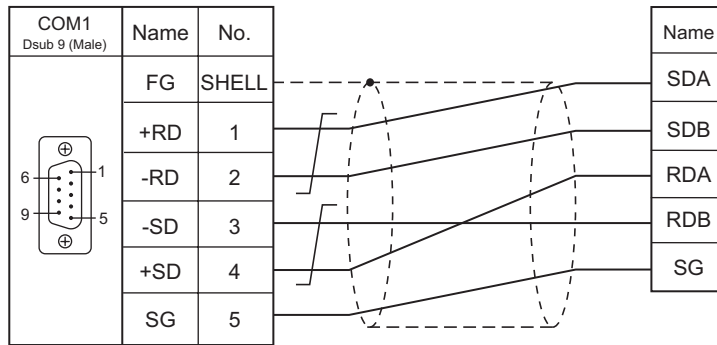

* DIPSW No. 2, 3: OFF

* Use shielded twist-pair cables.

Wiring diagram 2 - COM1

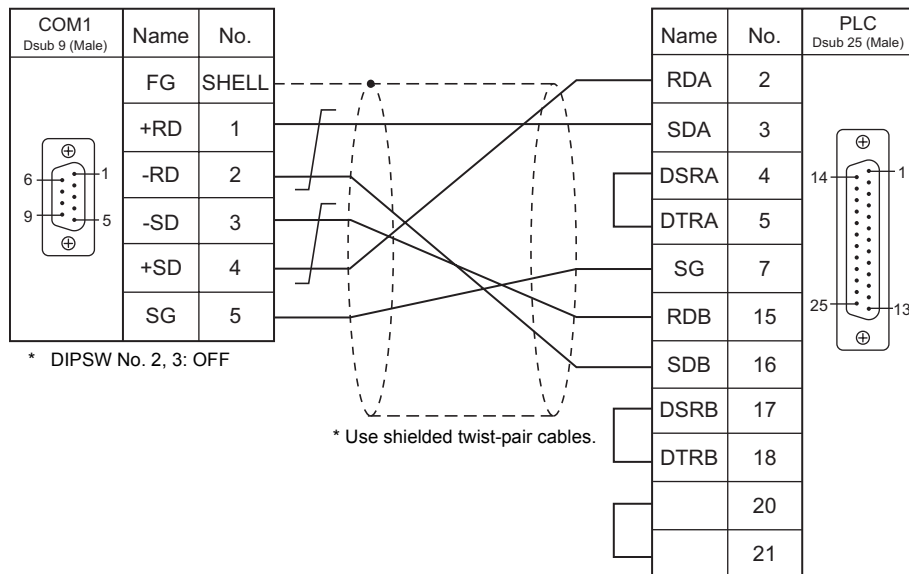

* DIPSW No. 2, 3: OFF

* Use shielded twist-pair cables.

When Connected at COM2:

RS-232C

Wiring diagram 1 - COM2

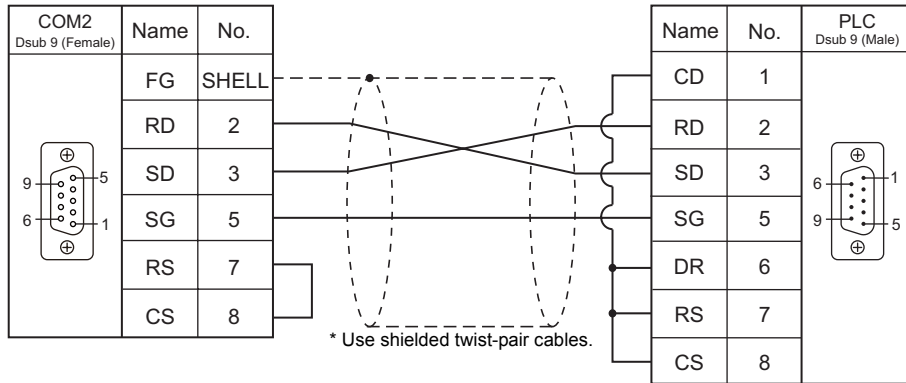

Wiring diagram 2 - COM2

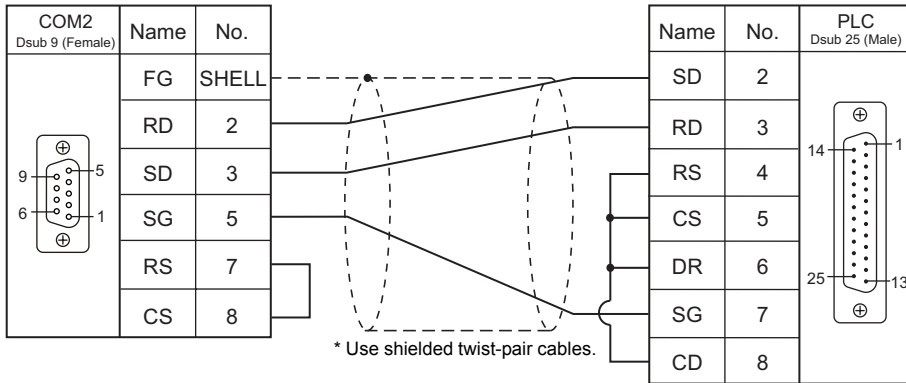

Wiring diagram 3 - COM2

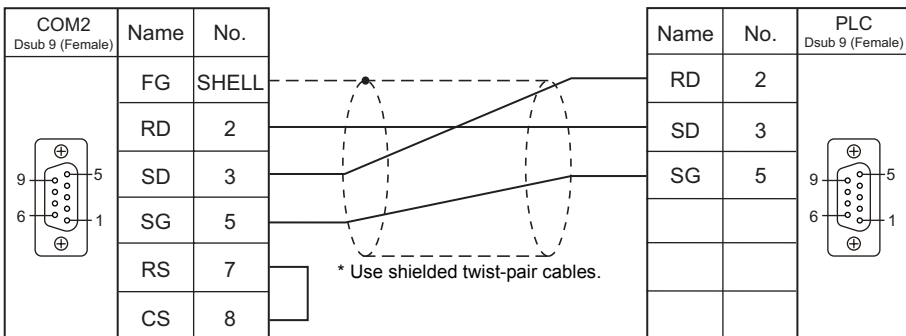

Wiring diagram 4 - COM2

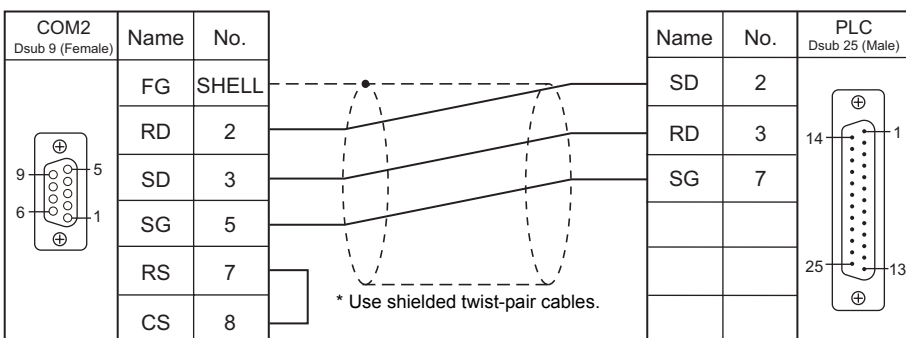

When Connected at COM3:

RS-485

Wiring diagram 1 - COM3

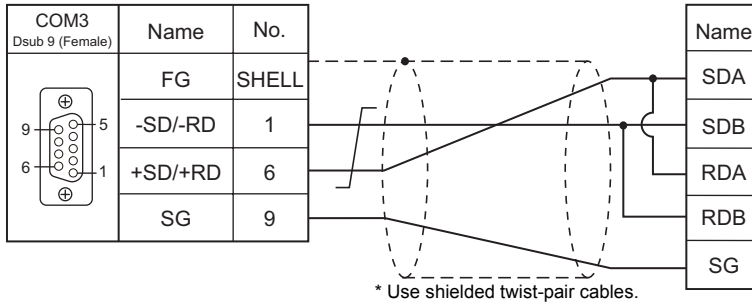

26.2 Temperature Controller/Servo/Inverter Connection

The controller models shown below can be connected.

Inverter

PLC Selection on the Editor	Model	Port	Signal Level	TS Port	Connection	Lst File
FR-*500	FR-A500 FR-E500 FR-F500	PU connector	RS-422	COM1	Wiring diagram 1 - COM1	FR-E500.Lst
			RS-485	COM3	Wiring diagram 1 - COM3	
	FR-S500	RS-485 connector	RS-422	COM1	Wiring diagram 1 - COM1	
			RS-485	COM3	Wiring diagram 1 - COM3	
FR-V500	FR-V500	PU connector	RS-422	COM1	Wiring diagram 1 - COM1	FR-V500.Lst
			RS-485	COM3	Wiring diagram 1 - COM3	
FR-E700	FR-E700	PU connector	RS-422	COM1	Wiring diagram 1 - COM1	FR-E700.Lst
			RS-485	COM3	Wiring diagram 1 - COM3	

Servo

PLC Selection on the Editor	Model	Port	Signal Level	TS Port	Connection	Lst File
MR-J2S-*A	MR-J2S-*A	CN3	RS-232C	COM2	Wiring diagram 1 - COM2	M_J2S_A.Lst
			RS-422	COM1	Wiring diagram 2 - COM1	
MR-J3-*A	MR-J3-*A	CN3	RS-422	COM1	Wiring diagram 1 - COM1	MRJ3.Lst
MR-J3-*T	MR-J3-*T	CN3				MRJ3_T.Lst

26.2.1 FR-*500

Communication Setting

Editor

Communication setting

(Underlined setting: default)

Item	Setting	Remarks
Connection Mode	1 : 1 / <u>1:n</u> / Multi-link2	
Signal Level	RS-232C / <u>RS-422/485</u>	
Baud Rate	4800 / 9600 / <u>19200</u> bps	
Data Length	7 / <u>8</u> bits	
Stop Bit	1 / <u>2</u> bits	
Parity	None / Odd / <u>Even</u>	
Target Port No.	<u>0</u> to 31	
CR/LF	None / <u>CR</u> / CRLF	

Inverter

(Underlined setting: default)

Parameter No.		Item	Setting	Setting Example
A500 E500 F500	S500 F500J			
77	77	Parameter writing permission	<u>0: Writing allowed when PU operation stops</u> 1: Writing prohibited 2: Writing allowed during operation	2: Writing allowed during operation
79	79	Operation mode selection *2	0 / <u>1</u> / 2 / 3 / 4 / 6 / 7 / 8	1: PU operation *3 2: External operation *3
117	n1	Communicating station number	<u>0</u> to 31	0
118	n2	Baud rate	4800 / 9600 / <u>19200</u> bps	19200 bps
119	n3	Data length / stop bit length	0: 8 bits / 1 bit <u>1: 8 bits / 2 bits</u> 10: 7 bits / 1 bit 11: 7 bits / 2 bits	1: 8 bits / 2 bits
120	n4	Parity check	0: None 1: Odd <u>2: Even</u>	2: Even
121	n5	Communication retrial times	<u>0</u> to 10 / 9999	9999: The inverter does not stop even if a communication alarm occurs.
122	n6	Communication check intervals *1	<u>0</u> / 0.1 to 999.8 / 9999	9999: Communication check stop
123	n7	Wait time	0 to 150 / <u>9999</u>	9999: Can be set with the communication data
-	n8	Operation command write	<u>0: Computer</u> 1: External	0: Computer
-	n9	Speed command write	<u>0: Computer</u> 1: External	0: Computer
-	n10	Link start mode selection *2	<u>0</u> 1: Computer link operation mode	1: Computer link operation mode
124	n11	CR/LF selection	0: CR/LF not provided <u>1: CR provided, LF not provided</u> 2: CR/LF provided	1: CR provided, LF not provided
146	-	Frequency setting *2	<u>0</u> / 1 / 9999	9999

*1 When the value in the range from 0.1 to 999.8 is set:

If the TS series does not start communication within the preset time, the inverter stops due to an alarm. This can be avoided by the periodical reading setting.

*2 When the inverter, FR-A500, FR-E500 or FR-F500, is turned on with the settings of Pr.79 = 0 and Pr.146 = 9999, the inverter enters in the PU operation mode.
When the inverter, FR-S500 or FR-F500J, is turned on with the settings of Pr.79 = 2 and n10 = 1, the inverter enters in the computer link operation mode.

*3 In the case of FR-A500, FR-E500 or FR-F500, when the running frequency change and operation command specification are made on the TS series, select the PU operation mode. In the case of FR-S500 or FR-F500J, when the running frequency change and operation command specification are made on the TS series, select the computer link operation mode. If those settings are not made on the TS series, set an appropriate value according to the purpose of usage.

Available Memory

The available memory setting range varies depending on the device. Be sure to set within the range available with the device to be used. Use [TYPE] when assigning the indirect memory for macro programs.

Memory	TYPE	Remarks
P (parameter)	00H	Refer to the list file or the parameter list for the inverter.
D (parameter)	01H	Refer to the table below.

Memory D (Parameter)

Address	Name																																																								
D0	Operation mode When issuing a command, such as a run command, from the TS series, select "Communication and Run". FR-E500 : 0002 H FR-A500 : 0002 H FR-F500 : 0002 H FR-S500 : 0000 H																																																								
D1	Output frequency (Rotation)																																																								
D2	Output current																																																								
D3	Output voltage																																																								
D4	Alarm contents (last / most recent) <table border="1"> <thead> <tr> <th>Data</th> <th>Contents</th> <th>Data</th> <th>Contents</th> <th>Data</th> <th>Contents</th> <th>Data</th> <th>Contents</th> </tr> </thead> <tbody> <tr> <td>H00</td> <td>none</td> <td>H22</td> <td>OV3</td> <td>H80</td> <td>GF</td> <td>HB2</td> <td>RET</td> </tr> <tr> <td>H10</td> <td>OC1</td> <td>H30</td> <td>THT</td> <td>H81</td> <td>LF</td> <td>HC2</td> <td>P24</td> </tr> <tr> <td>H11</td> <td>OC2</td> <td>H31</td> <td>THM</td> <td>H90</td> <td>OHT</td> <td>HF3</td> <td>E.3</td> </tr> <tr> <td>H12</td> <td>OC3</td> <td>H40</td> <td>FIN</td> <td>HA0</td> <td>OPT</td> <td>HF6</td> <td>E.6</td> </tr> <tr> <td>H20</td> <td>OV1</td> <td>H60</td> <td>OLT</td> <td>HB0</td> <td>PE</td> <td>HF7</td> <td>E.7</td> </tr> <tr> <td>H21</td> <td>OV2</td> <td>H70</td> <td>BE</td> <td>HB1</td> <td>PUE</td> <td></td> <td></td> </tr> </tbody> </table>	Data	Contents	Data	Contents	Data	Contents	Data	Contents	H00	none	H22	OV3	H80	GF	HB2	RET	H10	OC1	H30	THT	H81	LF	HC2	P24	H11	OC2	H31	THM	H90	OHT	HF3	E.3	H12	OC3	H40	FIN	HA0	OPT	HF6	E.6	H20	OV1	H60	OLT	HB0	PE	HF7	E.7	H21	OV2	H70	BE	HB1	PUE		
Data	Contents	Data	Contents	Data	Contents	Data	Contents																																																		
H00	none	H22	OV3	H80	GF	HB2	RET																																																		
H10	OC1	H30	THT	H81	LF	HC2	P24																																																		
H11	OC2	H31	THM	H90	OHT	HF3	E.3																																																		
H12	OC3	H40	FIN	HA0	OPT	HF6	E.6																																																		
H20	OV1	H60	OLT	HB0	PE	HF7	E.7																																																		
H21	OV2	H70	BE	HB1	PUE																																																				
D5	Alarm contents (three times before / two times before)																																																								
D6	Alarm contents (five times before / four times before) *																																																								
D7	Alarm contents (seven times before / six times before) *																																																								
D8	Inverter status monitor 																																																								
D9	Changeover to second parameter																																																								

* These memory addresses are not available for FR-S500

Note on Setting the Memory

Only the "List" file of "FR-E500" can be browsed by pressing the [Refer] button by default.

If the inverter such as "A500", "F500", or "S500" is used, refer to the parameter list described in each inverter's manual and set the memory.

PLC_CTL

Macro command "PLC_CTL F0 F1 F2"

Contents	F0	F1 (= \$u n)					F2	
Writing running frequency (EEPROM)	1 - 8 (PLC1 - 8)	n	Station number				3	
		n + 1	Command: 00EEH					
		n + 2	Running frequency					
Writing running frequency (RAM)	1 - 8 (PLC1 - 8)	n	Station number				3	
		n + 1	Command: 00EDH					
		n + 2	Running frequency					
All alarms clear	1 - 8 (PLC1 - 8)	n	Station number				2	
		n + 1	Command: 00F4H					
Operation command	1 - 8 (PLC1 - 8)	n	Station number				3	
		n + 1	Command: 00FAH					
		n + 2	0000H: Stop 0002H: Normal rotation (STF) 0004H: Reverse rotation (STR)					
All parameter clear	1 - 8 (PLC1 - 8)	n	Station number				3	
		n + 1	Command: 00FCH					
		n + 2	Pr.	Communication Pr.	Calibration	Other Pr.		00ECH 00F3H 00FFH
			Data					
			9696H	○	×	○		○
			9966H	○	○	○		○
5A5AH	×	×	○	○				
55AAH	×	○	○	○				
Inverter reset	1 - 8 (PLC1 - 8)	n	Station number				2	
		n+1	Command: 00FDH					

26.2.2 FR-V500

Communication Setting

Editor

Communication setting

(Underlined setting: default)

Item	Setting	Remarks
Connection Mode	1 : 1 / <u>1:n</u> / Multi-link2	
Signal Level	RS-232C / <u>RS-422/485</u>	
Baud Rate	4800 / 9600 / <u>19200</u> bps	
Data Length	7 / <u>8</u> bits	
Stop Bit	1 / <u>2</u> bits	
Parity	None / Odd / <u>Even</u>	
Target Port No.	<u>0</u> to 31	
CR/LF	None / <u>CR</u> / CRLF	

Inverter

(Underlined setting: default)

Parameter No.	Item	Setting	Setting Example
77	Parameter writing permission	<u>0: Writing allowed when PU operation stops</u> 1: Writing prohibited 2: Writing allowed during operation	2: Writing allowed during operation
79	Operation mode selection *2	<u>0</u> / 1 / 2 / 3 / 4 / 6 / 7 / 8	1: PU operation
117	Communicating station number	<u>0</u> to 31	0
118	Baud rate	4800 / 9600 / <u>19200</u> bps	19200 bps
119	Data length / stop bit length	0: 8 bits / 1 bit <u>1: 8 bits / 2 bits</u> 10: 7 bits / 1 bit 11: 7 bits / 2 bits	1: 8 bits / 2 bits
120	Parity check	0: None 1: Odd 2: Even	2: Even
121	Communication retrial times	0 to 10 / 9999	9999: The inverter does not stop even if a communication alarm occurs.
122	Communication check intervals *1	<u>0</u> / 0.1 to 999.8 / 9999	9999: Communication check stop
123	Wait time	0 to 150 / <u>9999</u>	9999: Can be set with the communication data
124	CR/LF selection	0: CR/LF not provided <u>1: CR provided, LF not provided</u> 2: CR/LF provided	1: CR provided, LF not provided
146	Frequency setting *2	<u>0</u> / 1 / 9999	9999

*1 When the value in the range from 0.1 to 999.8 is set:

If the TS series does not start communication within the preset time, the inverter stops due to an alarm. This can be avoided by the periodical reading setting.

*2 When the inverter is turned on with the settings of Pr.79=0 and Pr.146=9999, the inverter enters in the PU operation mode.

Available Memory

The available memory setting range varies depending on the device. Be sure to set within the range available with the device to be used. Use [TYPE] when assigning the indirect memory for macro programs.

Memory	TYPE	Remarks
P (parameter)	00H	Refer to the list file or the parameter list for the inverter.
D (parameter)	01H	Refer to the table below.

Memory D (Parameter)

Address	Name																																																																																																		
D0	Operation mode When issuing a command, such as a run command, from the TS series, select "Communication and Run". 0002 H																																																																																																		
D1	Rotation speed																																																																																																		
D2	Output current																																																																																																		
D3	Output voltage																																																																																																		
D4	Alarm contents (last / most recent)																																																																																																		
D5	Alarm contents (three times before / two times before)																																																																																																		
D6	Alarm contents (five times before / four times before)																																																																																																		
D7	Alarm contents (seven times before / six times before)																																																																																																		
D8	<p>Inverter status monitor</p>																																																																																																		
D9	Changeover to second parameter																																																																																																		
D10	Special monitor																																																																																																		
D11	<p>Special monitor selection No.</p> <table border="1"> <thead> <tr> <th>Data</th> <th>Contents</th> <th>Unit</th> <th>Data</th> <th>Contents</th> <th>Unit</th> </tr> </thead> <tbody> <tr> <td>H01</td> <td>Output frequency</td> <td>0.01 Hz</td> <td>H10</td> <td>Output terminal status</td> <td>-</td> </tr> <tr> <td>H02</td> <td>Output current</td> <td>0.01 A</td> <td>H11</td> <td>Load meter</td> <td>0.1%</td> </tr> <tr> <td>H03</td> <td>Output voltage</td> <td>0.1V</td> <td>H12</td> <td>Motor exciting current</td> <td>0.01A</td> </tr> <tr> <td>H05</td> <td>Speed setting</td> <td>1 r/min</td> <td>H13</td> <td>Position pulse</td> <td>-</td> </tr> <tr> <td>H06</td> <td>Operation speed</td> <td>1 r/min</td> <td>H14</td> <td>Total power-on time</td> <td>1h</td> </tr> <tr> <td>H07</td> <td>Motor torque</td> <td>0.1%</td> <td>H17</td> <td>Operating time</td> <td>1h</td> </tr> <tr> <td>H08</td> <td>Converter output</td> <td>0.1 V</td> <td>H18</td> <td>Motor load ratio</td> <td>0.1%</td> </tr> <tr> <td>H09</td> <td>Regenerative brake</td> <td>0.1%</td> <td>H20</td> <td>Torque command</td> <td>0.1%</td> </tr> <tr> <td>H0A</td> <td>Electric thermal load ratio</td> <td>0.1%</td> <td>H21</td> <td>Torque current command</td> <td>0.1%</td> </tr> <tr> <td>H0B</td> <td>Output current peak value</td> <td>0.01 A</td> <td>H22</td> <td>Motor output</td> <td>0.01 kW</td> </tr> <tr> <td>H0C</td> <td>Output voltage peak value of converter</td> <td>0.1 V</td> <td>H23</td> <td>Feed back pulse</td> <td>-</td> </tr> <tr> <td>H0F</td> <td>Input terminal status</td> <td>-</td> <td></td> <td></td> <td></td> </tr> </tbody> </table> <p>Input terminal status</p> <table border="1"> <tr> <td>Bit</td> <td>15</td> <td>-</td> <td>8</td> <td>RES</td> <td>CH</td> <td>DI4</td> <td>DI3</td> <td>DI2</td> <td>DI1</td> <td>STR</td> <td>STF</td> </tr> </table> <p>Output terminal status</p> <table border="1"> <tr> <td>Bit</td> <td>15</td> <td>-</td> <td>4</td> <td>ABC</td> <td>D03</td> <td>D02</td> <td>D01</td> </tr> </table>	Data	Contents	Unit	Data	Contents	Unit	H01	Output frequency	0.01 Hz	H10	Output terminal status	-	H02	Output current	0.01 A	H11	Load meter	0.1%	H03	Output voltage	0.1V	H12	Motor exciting current	0.01A	H05	Speed setting	1 r/min	H13	Position pulse	-	H06	Operation speed	1 r/min	H14	Total power-on time	1h	H07	Motor torque	0.1%	H17	Operating time	1h	H08	Converter output	0.1 V	H18	Motor load ratio	0.1%	H09	Regenerative brake	0.1%	H20	Torque command	0.1%	H0A	Electric thermal load ratio	0.1%	H21	Torque current command	0.1%	H0B	Output current peak value	0.01 A	H22	Motor output	0.01 kW	H0C	Output voltage peak value of converter	0.1 V	H23	Feed back pulse	-	H0F	Input terminal status	-				Bit	15	-	8	RES	CH	DI4	DI3	DI2	DI1	STR	STF	Bit	15	-	4	ABC	D03	D02	D01
Data	Contents	Unit	Data	Contents	Unit																																																																																														
H01	Output frequency	0.01 Hz	H10	Output terminal status	-																																																																																														
H02	Output current	0.01 A	H11	Load meter	0.1%																																																																																														
H03	Output voltage	0.1V	H12	Motor exciting current	0.01A																																																																																														
H05	Speed setting	1 r/min	H13	Position pulse	-																																																																																														
H06	Operation speed	1 r/min	H14	Total power-on time	1h																																																																																														
H07	Motor torque	0.1%	H17	Operating time	1h																																																																																														
H08	Converter output	0.1 V	H18	Motor load ratio	0.1%																																																																																														
H09	Regenerative brake	0.1%	H20	Torque command	0.1%																																																																																														
H0A	Electric thermal load ratio	0.1%	H21	Torque current command	0.1%																																																																																														
H0B	Output current peak value	0.01 A	H22	Motor output	0.01 kW																																																																																														
H0C	Output voltage peak value of converter	0.1 V	H23	Feed back pulse	-																																																																																														
H0F	Input terminal status	-																																																																																																	
Bit	15	-	8	RES	CH	DI4	DI3	DI2	DI1	STR	STF																																																																																								
Bit	15	-	4	ABC	D03	D02	D01																																																																																												

PLC_CTL

Macro command "PLC_CTL F0 F1 F2"

Contents	F0	F1 (= \$u n)					F2	
Writing setting speed (EEPROM)	1 - 8 (PLC1 - 8)	n	Station number				3	
		n + 1	Command: 00EEH					
		n + 2	Running frequency					
Writing setting speed (RAM)	1 - 8 (PLC1 - 8)	n	Station number				3	
		n + 1	Command: 00EDH					
		n + 2	Running frequency					
All alarms clear	1 - 8 (PLC1 - 8)	n	Station number				2	
		n + 1	Command: 00F4H					
Operation command	1 - 8 (PLC1 - 8)	n	Station number				3	
		n + 1	Command: 00FAH					
		n + 2	0000H: Stop 0002H: Normal rotation (STF) 0004H: Reverse rotation (STR)					
All parameter clear	1 - 8 (PLC1 - 8)	n	Station number				3	
		n + 1	Command: 00FCH					
		n + 2	Pr.	Communication Pr.	Calibration	Other Pr.		00ECH 00F3H 00FFH
			Data					
			9696H	○	×	○		○
			9966H	○	○	○		○
5A5AH	×	×	○	○				
55AAH	×	○	○	○				
Inverter reset	1 - 8 (PLC1 - 8)	n	Station number				2	
		n+1	Command: 00FDH					

26.2.3 MR-J2S-*A

Communication Setting

Editor

Communication setting

(Underlined setting: default)

Item	Setting	Remarks
Connection Mode	1 : 1 / <u>1:1</u> / Multi-link2 / Multi-link2 (Ethernet)	
Signal Level	<u>RS-232C</u> / RS-422/485	
Baud Rate	<u>9600</u> / 19200 / 38400 / 57600 bps	
Data Length	8 bits (fixed)	
Stop Bit	1 bit (fixed)	
Parity	Even (fixed)	
Target Port No.	<u>0</u> to 31	

Servo amplifier

Extension setting parameters

To make the parameter setting valid, the power supply is turned on again.

(Underlined setting: default)

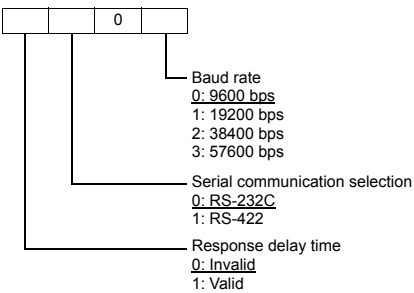
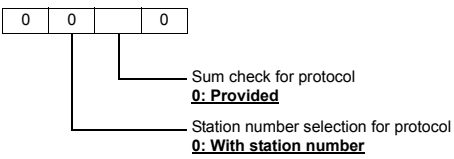
Parameter No.	Symbol	Item	Setting Example
15	SNO	Station number setting	<u>0</u> to 31
16	BPS	Communication function selection	 <p>Baud rate <u>0: 9600 bps</u> 1: 19200 bps 2: 38400 bps 3: 57600 bps</p> <p>Serial communication selection <u>0: RS-232C</u> 1: RS-422</p> <p>Response delay time <u>0: Invalid</u> 1: Valid</p>
53	OP8	Function selection 8	 <p>Sum check for protocol <u>0: Provided</u></p> <p>Station number selection for protocol <u>0: With station number</u></p>

Available Memory

The available memory setting range varies depending on the device. Be sure to set within the range available with the device to be used. Use [TYPE] when assigning the indirect memory for macro programs.

Memory	TYPE	Remarks
F01 (status display/fraction display)	00H	Real number, read only
05 (parameter)	01H	Double-word
F05 (parameter/fraction display)	02H	Real number
12 (External I/O signals)	03H	Double-word, partially read only
33 (Alarm history)	04H	Double-word, read only
02 (Current alarm)	05H	Read only
F35 (Status display at alarm occurrence/fraction display)	06H	Real number, read only
42 (Other commands)	0DH	Double-word, read only
81 (Status display data erasure)	0EH	Write only
82 (Alarm history erasure)	0FH	Write only
8B (Operation mode selection)	10H	Write only
90 (I/O device prohibition/cancel)	11H	Write only
92 (Input device ON/OFF)	12H	Double-word, write only
A0 (Test operation mode data)	13H	Double-word, write only

Set the target memory on the [Memory Input] dialog.

- RAM: Stored in RAM
- EEPROM: Stored in RAM + EEPROM

Indirect Memory Designation

- Address No. 0 to 65535

	15	8	7	0
n+0	Models		Memory Type	
n+1	Address No.			
n+2	Expansion code *		Bit designation	
n+3	00		Station number	

* Expansion code

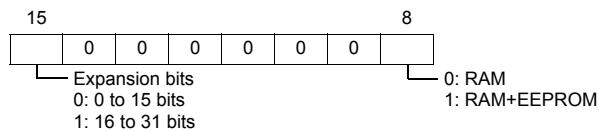

PLC_CTL

Macro command "PLC_CTL F0 F1 F2"

Contents	F0	F1 (= \$u n)	F2
Software version	1 - 8 (PLC1 - 8)	n	Station number
		n + 1	Command: 0002H
		n + 2	Data No. 0070H
		n+3 to n+10	Software version
			3

Return data: Data stored from controller to TS series

26.2.4 MR-J3-*A

Communication Setting

Editor

Communication setting

(Underlined setting: default)

Item	Setting	Remarks
Connection Mode	1 : 1 / <u>1:1</u> / Multi-link2 / Multi-link2 (Ethernet)	
Signal Level	RS-232C / <u>RS-422/485</u>	
Baud Rate	<u>9600</u> / 19200 / 38400 / 57600 / 115K bps	
Data Length	8 bits (fixed)	
Stop Bit	1 bit (fixed)	
Parity	Even (fixed)	
Target Port No.	<u>0</u> to 31	

Servo amplifier

Extension setting parameters

To make the parameter setting valid, the power supply is turned on again.

(Underlined setting: default)

Parameter No.	Symbol	Item	Setting Example
PC20	SNO	Station number setting	<u>0</u> to 31
PC21	SOP	Communication function selection	<p>Response delay time 0: Invalid 1: Valid</p> <p>Baud rate 0: 9600 bps 1: 19200 bps 2: 38400 bps 3: 57600 bps 4: 115200 bps</p>

Available Memory

The available memory setting range varies depending on the device. Be sure to set within the range available with the device to be used. Use [TYPE] when assigning the indirect memory for macro programs.

Memory	TYPE	Remarks
F01 (status display)	00H	Real number, read only
12 (external I/O signals)	03H	Double-word, partially read only
33 (alarm history)	04H	Double-word, read only
02 (current alarm)	05H	Read only
F35 (status display at alarm occurrence)	06H	Real number, read only
42 (other commands)	0DH	Double-word, read only
81 (status display data erasure)	0EH	Write only
82 (alarm history erasure)	0FH	Write only
8B (operation mode selection)	10H	
90 (I/O device prohibition/cancel)	11H	Write only
92 (input device ON/OFF)	12H	Double-word, write only
A0 (test operation mode data)	13H	Double-word, write only
S01 (status display name and unit)	14H	Read only
04 (parameters)	15H	
05A (basic setting parameters)	16H	Double-word
05B (gain/filter parameters)	17H	Double-word
05C (extension setting parameters)	18H	Double-word
05D (I/O setting parameters)	19H	Double-word
F05A (basic setting parameters)	1AH	Real number
F05B (gain/filter parameters)	1BH	Real number
F05C (extension setting parameters)	1CH	Real number
F05D (I/O setting parameters)	1DH	Real number
06A (basic setting parameters upper limit)	1EH	Double-word, read only

Memory	TYPE	Remarks
06B (gain/filter parameters upper limit)	1FH	Double-word, read only
06C (extension setting parameters upper limit)	20H	Double-word, read only
06D (I/O setting parameters upper limit)	21H	Double-word, read only
F06A (basic setting parameters upper limit)	22H	Real number, read only
F06B (gain/filter parameters upper limit)	23H	Real number, read only
F06C (extension setting parameters upper limit)	24H	Real number, read only
F06D (I/O setting parameters upper limit)	25H	Real number, read only
07A (basic setting parameters lower limit)	1EH	Double-word, read only
07B (gain/filter parameters lower limit)	1FH	Double-word, read only
07C (extension setting parameters lower limit)	20H	Double-word, read only
07D (I/O setting parameters lower limit)	21H	Double-word, read only
F07A (basic setting parameters lower limit)	22H	Real number, read only
F07B (gain/filter parameters lower limit)	23H	Real number, read only
F07C (extension setting parameters lower limit)	24H	Real number, read only
F07D (I/O setting parameters lower limit)	25H	Real number, read only
S08A (basic setting parameters symbol)	2EH	Read only
S08B (gain/filter parameters symbol)	2FH	Read only
S08C (extension setting parameters symbol)	30H	Read only
S08D (I/O setting parameters symbol)	31H	Read only
09A (write enable/disable of basic setting parameters)	32H	Read only
09B (write enable/disable of Gain/filter parameters)	33H	Read only
09C (write enable/disable of Extension setting parameters)	34H	Read only
09D (write enable/disable of I/O setting parameters)	35H	Read only

Set the target memory on the [Memory Input] dialog.

- RAM: Stored in RAM
- EEPROM: Stored in RAM + EEPROM

Indirect Memory Designation

- Address No. 0 to 65535

	15	8	7	0
n+0	Models		Memory Type	
n+1	Address No.			
n+2	Expansion code *		Bit designation	
n+3	00		Station number	

* Expansion code

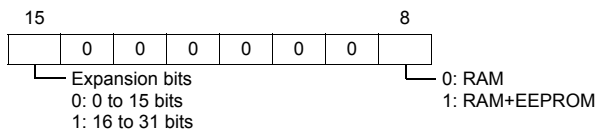

PLC_CTL

Macro command "PLC_CTL F0 F1 F2"

Contents	F0	F1 (= \$u n)		F2
Software version	1 - 8 (PLC1 - 8)	n	Station number	3
		n + 1	Command: 0002H	
		n + 2	Data No. 0070H	
		n+3 to n+10	Software version	

Return data: Data stored from controller to TS series

26.2.5 MR-J3-*T

Communication Setting

Editor

Communication setting

(Underlined setting: default)

Item	Setting	Remarks
Connection Mode	1 : 1 / <u>1: 0</u> / Multi-link2 / Multi-link2(Ethernet)	
Signal Level	RS-232C / <u>RS-422/485</u>	
Baud Rate	<u>9600</u> / 19200 / 38400 / 57600 / 115K bps	
Data Length	8 bits (fixed)	
Stop Bit	1 bit (fixed)	
Parity	Even (fixed)	
Target Port No.	<u>0</u> to 31	

Servo amplifier

Extension setting parameters

To make the parameter setting valid, the power supply is turned on again.

(Underlined setting: default)

Parameter No.	Symbol	Item	Setting Example
PC20	SNO	Station number setting	<u>0</u> to 31
PC21	SOP	Communication function selection	<p>Response delay time 0: Invalid 1: Valid</p> <p>Baud rate 0: 9600 bps 1: 19200 bps 2: 38400 bps 3: 57600 bps 4: 115200 bps</p>

Available Memory

The available memory setting range varies depending on the device. Be sure to set within the range available with the device to be used. Use [TYPE] when assigning the indirect memory for macro programs.

Memory	TYPE	Remarks
F01 (status display)	00H	Real number, read only
12 (external I/O signals)	03H	Double-word, partially read only
33 (alarm history)	04H	Double-word, read only
02 (current alarm)	05H	Read only
F35 (status display at alarm occurrence)	06H	Real number, read only
42 (other commands)	0DH	Double-word, read only
81 (status display data erasure)	0EH	Write only
82 (alarm history erasure)	0FH	Write only
8B (operation mode selection)	10H	
90 (I/O device prohibition/cancel)	11H	Write only
92 (input device ON/OFF)	12H	Double-word, write only
A0 (test operation mode data)	13H	Double-word, write only
S01 (status display name and unit)	14H	Read only
04 (parameters)	15H	
05A (basic setting parameters)	16H	Double-word
05B (gain/filter parameters)	17H	Double-word
05C (extension setting parameters)	18H	Double-word
05D (I/O setting parameters)	19H	Double-word
F05A (basic setting parameters)	1AH	Real number
F05B (gain/filter parameters)	1BH	Real number
F05C (extension setting parameters)	1CH	Real number
F05D (I/O setting parameters)	1DH	Real number
06A (basic setting parameters upper limit)	1EH	Double-word, read only

Memory	TYPE	Remarks
06B (gain/filter parameters upper limit)	1FH	Double-word, read only
06C (extension setting parameters upper limit)	20H	Double-word, read only
06D (I/O setting parameters upper limit)	21H	Double-word, read only
F06A (basic setting parameters upper limit)	22H	Real number, read only
F06B (gain/filter parameters upper limit)	23H	Real number, read only
F06C (extension setting parameters upper limit)	24H	Real number, read only
F06D (I/O setting parameters upper limit)	25H	Real number, read only
07A (basic setting parameters lower limit)	1EH	Double-word, read only
07B (gain/filter parameters lower limit)	1FH	Double-word, read only
07C (extension setting parameters lower limit)	20H	Double-word, read only
07D (I/O setting parameters lower limit)	21H	Double-word, read only
F07A (basic setting parameters lower limit)	22H	Real number, read only
F07B (gain/filter parameters lower limit)	23H	Real number, read only
F07C (extension setting parameters lower limit)	24H	Real number, read only
F07D (I/O setting parameters lower limit)	25H	Real number, read only
S08A (basic setting parameters symbol)	2EH	Read only
S08B (gain/filter parameters symbol)	2FH	Read only
S08C (extension setting parameters symbol)	30H	Read only
S08D (I/O setting parameters symbol)	31H	Read only
09A (write enable/disable of basic setting parameters)	32H	Read only
09B (write enable/disable of gain/filter parameters)	33H	Read only
09C (write enable/disable of extension setting parameters)	34H	Read only
09D (write enable/disable of I/O setting parameters)	35H	Read only
F40 (point table Point data)	36H	Real number
50 (point table Servo motor speed)	37H	Double-word
54 (point table Acceleration time constant)	38H	Double-word
58 (point table Deceleration time constant)	39H	Double-word
60 (point table Dwell)	3AH	Double-word
64 (point table Auxiliary function)	3BH	Double-word
45 (point table M code)	3CH	Double-word

Set the target memory on the [Memory Input] dialog.

- RAM: Stored in RAM
- EEPROM: Stored in RAM + EEPROM

Indirect Memory Designation

- Address No. 0 to 65535

	15	8	7	0
n+0	Models		Memory Type	
n+1	Address No.			
n+2	Expansion code *		Bit designation	
n+3	00		Station number	

* Expansion code

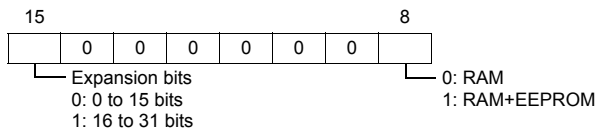

PLC_CTL

Macro command "PLC_CTL F0 F1 F2"

Contents	F0	F1 (= \$u n)		F2
Software version	1 - 8 (PLC1 - 8)	n	Station number	3
		n + 1	Command: 0002H	
		n + 2	Data No. 0070H	
		n+3 to n+10	Software version	
Option unit parameter Read	1 - 8 (PLC1 - 8)	n	Station number	4
		n + 1	Command: 0005H	
		n + 2	Data Type 0: Normal 1: Real number (decimal)	
		n + 3	Parameter No. *1	
		n + 4	Parameter (low-order)	
n + 5	Parameter (high-order)			
Option unit parameter Write	1 - 8 (PLC1 - 8)	n	Station number	7
		n + 1	Command: 0084H	
		n + 2	Data Type 0: Normal 1: Real number (decimal)	
		n + 3	Parameter No. *1	
		n + 4	Parameter (low-order)	
		n + 5	Parameter (low-order)	
Option unit parameter upper limit values read	1 - 8 (PLC1 - 8)	n	Station number	4
		n + 1	Command: 0006H	
		n + 2	Data Type 0: Normal 1: Real number (decimal)	
		n + 3	Parameter No. *1	
		n + 4	Parameter (low-order)	
n + 5	Parameter (high-order)			
Option unit parameter lower limit values read	1 - 8 (PLC1 - 8)	n	Station number	4
		n + 1	Command: 0007H	
		n + 2	Data Type 0: Normal 1: Real number (decimal)	
		n + 3	Parameter No. *1	
		n + 4	Parameter (low-order)	
n + 5	Parameter (high-order)			
Option unit parameter Abbreviations read	1 - 8 (PLC1 - 8)	n	Station number	3
		n + 1	Command: 0008H	
		n + 2	Parameter No. *1	
		n+3 to n+7	Abbreviations	
Option unit parameter Write enable/disable read	1 - 8 (PLC1 - 8)	n	Station number	3
		n + 1	Command: 0009H	
		n + 2	Parameter No. *1	
		n+3	0: Write enabled 1: Write disabled	

Return data: Data stored from controller to TS series

*1 Option unit parameter

No.	Contents
2	MR-J3-D01 Input signal device selection 1 (CN10-21, 26)
3	MR-J3-D01 Input signal device selection 2 (CN10-27, 28)
4	MR-J3-D01 Input signal device selection 3 (CN10-29, 30)
5	MR-J3-D01 Input signal device selection 4 (CN10-31, 32)
6	MR-J3-D01 Input signal device selection 5 (CN10-33, 34)
7	MR-J3-D01 Input signal device selection 6 (CN10-35, 36)
8	MR-J3-D01 Output signal device selection 1 (CN10-46, 47)
9	MR-J3-D01 Output signal device selection 2 (CN10-48, 49)

No.	Contents
10	Function selection O-1
12	Function selection O-3
13	MR-J3-D01 Analog monitor 1 output
14	MR-J3-D01 Analog monitor 2 output
15	MR-J3-D01 Analog monitor 1 offset
16	MR-J3-D01 Analog monitor 2 offset
21	MR-J3-D01 Override offset
22	MR-J3-D01 Analog torque limit offset

26.2.6 FR-E700

Communication Setting

Editor

Communication setting

(Underlined setting: default)

Item	Setting	Remarks
Connection Mode	1 : 1 / <u>1 : n</u> / Multi-link2 / Multi-link2(Ethernet)	
Signal Level	RS-232C / <u>RS-422/485</u>	
Baud Rate	4800 / 9600 / <u>19200</u> bps	
Data Length	7 / <u>8</u> bits	
Stop Bit	1 / <u>2</u> bits	
Parity	None / Odd / <u>Even</u>	
Target Port No.	<u>0</u> to 31	
CR/LF	None / <u>CR</u> / CRLF	

Inverter

When setting run commands and set frequency commands from TS, select the Network operation mode. For more information, refer to the Instruction Manual (Applied) of inverter.

Be sure to reset the inverter after making the initial settings of the parameters. Otherwise, communication is not possible.

(Underlined setting: default)

Parameter No.	Item	Setting	Setting Example
77	Parameter writing permission	<u>0: Writing allowed when PU operation stops</u> 1: Writing prohibited 2: Writing allowed during operation	2
79	Operation mode selection *3	<u>0</u> / 1 / 2 / 3 / 4 / 6 / 7	2 : External operation mode
117	PU communication station number	<u>0</u> to 31	0
118	PU communication speed	4800 / 9600 / <u>19200</u> / 38400bps	19200 bps
119	PU communication stop bit length (data length)	0: 8 bits / 1 bit <u>1: 8 bits / 2 bits</u> 10: 7 bits / 1 bit 11: 7 bits / 2 bits	1
120	PU communication parity check	0: None 1: Odd <u>2: Even</u>	2
121	Number of PU communication retries	0 to 10 / 9999	9999: The inverter does not stop even if a communication alarm occurs.
122	PU communication check time interval	<u>0</u> *1 0.1 to 999.8 *2 9999	9999: No communication check
123	PU communication waiting time setting	0 to 150 / <u>9999</u>	9999: Can be set with the communication data
124	PU communication CR/LF selection	0: Without CR/LF <u>1: With CR</u> 2: With CR/LF	1
338	Communication operation command source	<u>0: communication</u> 1: external	0
339	Communication speed command source	<u>0: communication</u> 1: external (communication invalid) 2: external (communication valid)	0
340	Communication startup mode selection *3	<u>0: As set in Pr.79</u> 1: Network operation mode 10: Network operation mode *4	1
549	Protocol selection	<u>0: Mitsubishi inverter protocol</u> 1: Modbus-RTU protocol	0
550	NET mode operation command source selection	0: communication option 2: PU connector <u>9999: Automatic communication option recognition</u>	9999 When using a communication option set 2.
551	PU mode operation command source selection	2: PU connector 3: USB connector 4: Operation panel <u>9999: USB automatic recognition</u>	9999

- *1 RS-485 communication is possible. Note that a communication fault (E.PUE) occurs as soon as the inverter is switched to the operation mode with command source.
- *2 When the value in the range from 0.1 to 999.8 is set:
If the TS series does not start communication within the preset time, the inverter stops due to an alarm. This can be avoided by the periodical reading setting.
- *3 When the inverter is turned on with the settings of Pr.79=0/2/6 and Pr.340=1, the inverter enters in the Network operation mode.
- *4 Operation mode can be changed between the PU operation mode and Network operation mode from the operation panel.

Available Memory

The available memory setting range varies depending on the device. Be sure to set within the range available with the device to be used. Use [TYPE] when assigning the indirect memory for macro programs.

Memory	TYPE	Remarks
P (parameter)	00H	Refer to the list file or the parameter list for the inverter.
D (parameter)	01H	Refer to the table below.

Memory D (Parameter)

Address	Name																																																																																																														
D0	Operation mode 0000 H: Network operation 0001 H: External operation 0002 H: PU operation																																																																																																														
D1	Pr.37=0 : Frequency display, setting Pr.37=0 : Machine speed at 60 Hz																																																																																																														
D2	Output current																																																																																																														
D3	Output voltage																																																																																																														
D4	Fault description (First fault in past / Latest fault)																																																																																																														
D5	Fault description (Third fault in past / Second fault in past)																																																																																																														
D6	Fault description (Fifth fault in past / Fourth fault in past)																																																																																																														
D7	Fault description (Seventh fault in past / Sixth fault in past)																																																																																																														
D8	<p>Inverter status monitor</p> <p style="text-align: center;">* Definitions change according to the Pr.190 to 192.</p>																																																																																																														
D9	Second parameter changing																																																																																																														
D10	Special monitor																																																																																																														
D11	<p>Special monitor selection No.</p> <table border="1" style="width: 100%;"> <thead> <tr> <th>Data</th> <th>Contents</th> <th>Unit</th> <th>Data</th> <th>Contents</th> <th>Unit</th> </tr> </thead> <tbody> <tr> <td>H01</td> <td>Output frequency / speed</td> <td>0.01 Hz / 0.001</td> <td>H10</td> <td>Output terminal status*2</td> <td>-</td> </tr> <tr> <td>H02</td> <td>Output current</td> <td>0.01 A</td> <td>H14</td> <td>Cumulative energization time</td> <td>1 h</td> </tr> <tr> <td>H03</td> <td>Output voltage</td> <td>0.1V</td> <td>H17</td> <td>Actual operating time</td> <td>1 h</td> </tr> <tr> <td>H05</td> <td>Frequency setting / speed setting</td> <td>0.01 HZ / 0.001</td> <td>H18</td> <td>Motor load factor</td> <td>0.1%</td> </tr> <tr> <td>H07</td> <td>Motor torque</td> <td>0.1 %</td> <td>H19</td> <td>Cumulative power</td> <td>1 kWh</td> </tr> <tr> <td>H08</td> <td>Converter output voltage</td> <td>0.1 V</td> <td>H34</td> <td>PID set point</td> <td>0.1 %</td> </tr> <tr> <td>H09</td> <td>Regenerative brake duty</td> <td>0.1 %</td> <td>H35</td> <td>PID measured value</td> <td>0.1 %</td> </tr> <tr> <td>H0A</td> <td>Electric thermal relay function load factor</td> <td>0.1 %</td> <td>H36</td> <td>PID deviation</td> <td>0.1 %</td> </tr> <tr> <td>H0B</td> <td>Output current peak value</td> <td>0.01 A</td> <td>H3A</td> <td>Option input terminal status1 *3</td> <td>-</td> </tr> <tr> <td>H0C</td> <td>Converter output voltage peak value</td> <td>0.1 V</td> <td>H3B</td> <td>Option input terminal status2 *3</td> <td>-</td> </tr> <tr> <td>H0E</td> <td>Output power</td> <td>0.01 kW</td> <td>H3C</td> <td>Option output terminal status *3</td> <td>-</td> </tr> <tr> <td>H0F</td> <td>Input terminal status*1</td> <td>-</td> <td></td> <td></td> <td></td> </tr> </tbody> </table> <p>*1 Input terminal status</p> <table border="1" style="width: 100%; text-align: center;"> <tr> <td>-</td><td>-</td><td>-</td><td>-</td><td>-</td><td>RES</td><td>-</td><td>MRS</td><td>-</td><td>RH</td><td>RM</td><td>RL</td><td>-</td><td>-</td><td>STR</td><td>STF</td> </tr> </table> <p>*2 Output terminal status</p> <table border="1" style="width: 100%; text-align: center;"> <tr> <td>-</td><td>-</td><td>-</td><td>-</td><td>-</td><td>-</td><td>-</td><td>-</td><td>-</td><td>-</td><td>ABC</td><td>FU</td><td>-</td><td>-</td><td>-</td><td>RUN</td> </tr> </table> <p>*3 Refer to the manual of the inverter.</p>	Data	Contents	Unit	Data	Contents	Unit	H01	Output frequency / speed	0.01 Hz / 0.001	H10	Output terminal status*2	-	H02	Output current	0.01 A	H14	Cumulative energization time	1 h	H03	Output voltage	0.1V	H17	Actual operating time	1 h	H05	Frequency setting / speed setting	0.01 HZ / 0.001	H18	Motor load factor	0.1%	H07	Motor torque	0.1 %	H19	Cumulative power	1 kWh	H08	Converter output voltage	0.1 V	H34	PID set point	0.1 %	H09	Regenerative brake duty	0.1 %	H35	PID measured value	0.1 %	H0A	Electric thermal relay function load factor	0.1 %	H36	PID deviation	0.1 %	H0B	Output current peak value	0.01 A	H3A	Option input terminal status1 *3	-	H0C	Converter output voltage peak value	0.1 V	H3B	Option input terminal status2 *3	-	H0E	Output power	0.01 kW	H3C	Option output terminal status *3	-	H0F	Input terminal status*1	-				-	-	-	-	-	RES	-	MRS	-	RH	RM	RL	-	-	STR	STF	-	-	-	-	-	-	-	-	-	-	ABC	FU	-	-	-	RUN
Data	Contents	Unit	Data	Contents	Unit																																																																																																										
H01	Output frequency / speed	0.01 Hz / 0.001	H10	Output terminal status*2	-																																																																																																										
H02	Output current	0.01 A	H14	Cumulative energization time	1 h																																																																																																										
H03	Output voltage	0.1V	H17	Actual operating time	1 h																																																																																																										
H05	Frequency setting / speed setting	0.01 HZ / 0.001	H18	Motor load factor	0.1%																																																																																																										
H07	Motor torque	0.1 %	H19	Cumulative power	1 kWh																																																																																																										
H08	Converter output voltage	0.1 V	H34	PID set point	0.1 %																																																																																																										
H09	Regenerative brake duty	0.1 %	H35	PID measured value	0.1 %																																																																																																										
H0A	Electric thermal relay function load factor	0.1 %	H36	PID deviation	0.1 %																																																																																																										
H0B	Output current peak value	0.01 A	H3A	Option input terminal status1 *3	-																																																																																																										
H0C	Converter output voltage peak value	0.1 V	H3B	Option input terminal status2 *3	-																																																																																																										
H0E	Output power	0.01 kW	H3C	Option output terminal status *3	-																																																																																																										
H0F	Input terminal status*1	-																																																																																																													
-	-	-	-	-	RES	-	MRS	-	RH	RM	RL	-	-	STR	STF																																																																																																
-	-	-	-	-	-	-	-	-	-	ABC	FU	-	-	-	RUN																																																																																																

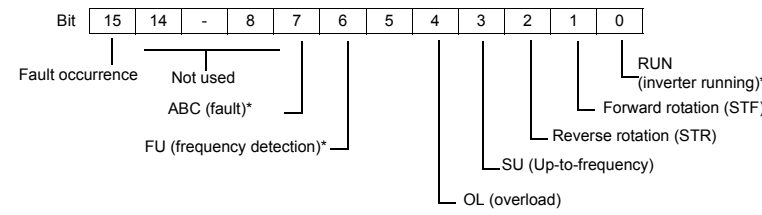
Address	Name
D12	Inverter status monitor (expansion)  * Definitions change according to the Pr.190 to 192.

PLC_CTL

Macro command "PLC_CTL F0 F1 F2"

Contents	F0	F1 (= \$u n)					F2	
Read set frequency (EEPROM)	1 - 8 (PLC1 - 8)	n	Station number					2
		n + 1	Command: 006EH					
		n + 2	0 to 65535Hz Pr.37=0 Set frequency in 0.01Hz Pr.37≠0 Speed 0.001					
Read set frequency (RAM)	1 - 8 (PLC1 - 8)	n	Station number					2
		n + 1	Command: 006DH					
		n + 2	0 to 65535Hz Pr.37=0 Set frequency in 0.01Hz Pr.37≠0 Speed 0.001					
Write set frequency (EEPROM)	1 - 8 (PLC1 - 8)	n	Station number					3
		n + 1	Command: 00EEH					
		n + 2	0 to 40000Hz Pr.37=0 Set frequency in 0.01Hz Pr.37≠0 Speed 0.001					
Write set frequency (RAM)	1 - 8 (PLC1 - 8)	n	Station number					3
		n + 1	Command: 00EDH					
		n + 2	0 to 40000Hz Pr.37=0 Set frequency in 0.01Hz Pr.37≠0 Speed 0.001					
Inverter reset	1 - 8 (PLC1 - 8)	n	Station number					3
		n+1	Command: 00FDH					
		n + 2	9696H: Makes the inverter reset without reply after receiving command. 9966H: Returns ACK and makes the inverter reset after receiving a command.					
All parameter clear	1 - 8 (PLC1 - 8)	n	Station number					3
		n + 1	Command: 00FCH					
		n + 2	Pr.	Communication Pr.	Calibration Pr.	Other Pr.	00ECH 00F3H 00FFH	
			9696H *1	○	×	○	○	
			9966H *1	○	○	○	○	
5A5AH	×		×	○	○			
55AAH	×	○	○	○				

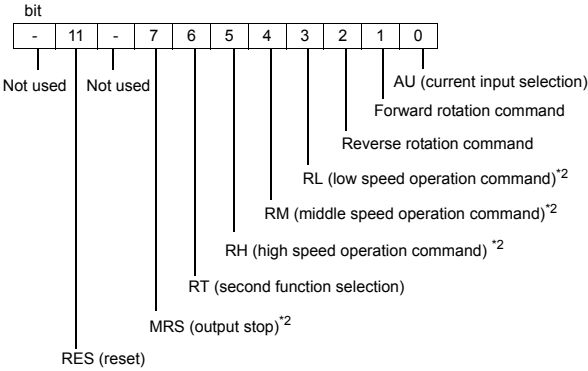
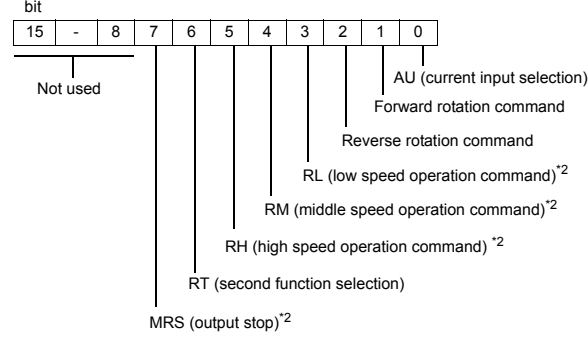
Contents	F0	F1 (= \$u n)		F2
Write run command (Expansion)	1 - 8 (PLC1 - 8)	n	Station number	3
		n+1	Command: 00F9H	
		n + 2	0000H: stop 	
Write run command	1 - 8 (PLC1 - 8)	n	Station number	3
		n + 1	Command: 00FAH	
		n + 2	0000H: stop 	
All alarms clear	1 - 8 (PLC1 - 8)	n	Station number	2
		n + 1	Command: 00F4H	

Return data: Data stored from controller to TS series

- *1 When executing this command, the setting values of communication parameter for TS series are also returned to the initial values. Set the parameter again.
- *2 The description changes depending on the setting of Pr.180 to 184.

26.2.7 Wiring Diagrams

When Connected at COM1:

RS-422

Wiring diagram 1 - COM1

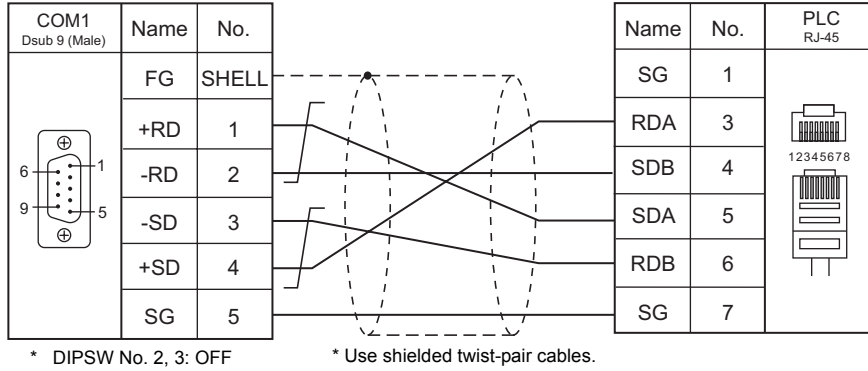

Wiring diagram 2 - COM1

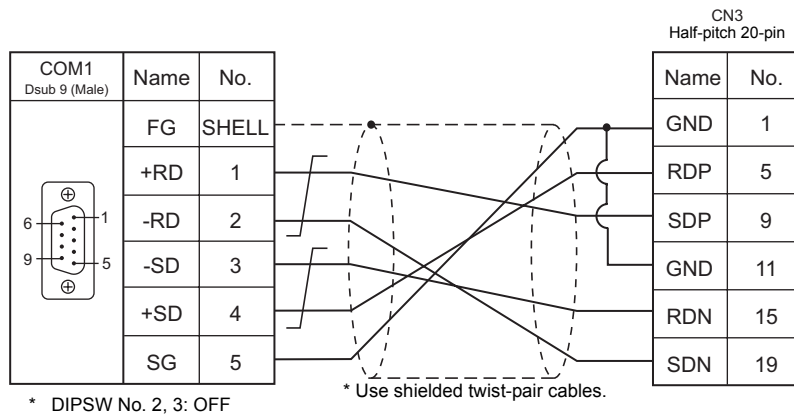

When Connected at COM2:

RS-232C

Wiring diagram 1 - COM2

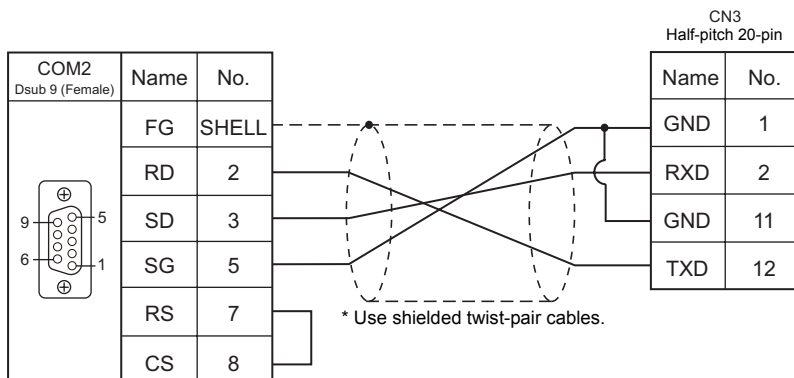

When Connected at COM3:

RS-485

Wiring diagram 1 - COM3

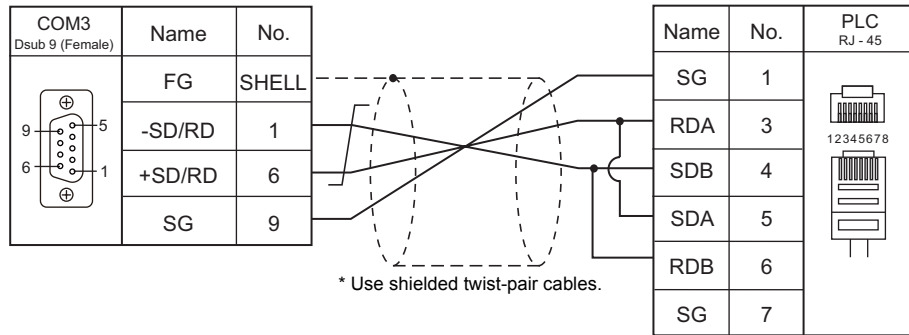

MEMO

Please use this page freely.

27. MODICON

27.1 PLC Connection

27.1 PLC Connection

Serial Connection

PLC Selection on the Editor	CPU		Unit/Port	Signal Level	TS Port	Connection	Ladder Transfer *1
Modbus RTU	Quantum	140 CPU 113 02 140 CPU 113 03 140 CPU 331 10 140 CPU 434 12A 140 CPU 434 12B 140 CPU 434 12U 140 CPU 534 14U 140 CPU 651 50 140 CPU 651 60 140 CPU 671 60(HSBY)	COMM1	RS-232C	COM2	Wiring diagram 1 - COM2	×

*1 For the ladder transfer function, see "Appendix 5 Ladder Transfer Function".

27.1.1 Modbus RTU

Communication Setting

Editor

Communication setting

(Underlined setting: default)

Item	Setting	Remarks
Connection Mode	<u>1</u> : 1 / Multi-link2 / Multi-link2 (Ethernet)	
Signal Level	<u>RS-232C</u>	
Baud Rate	4800 / <u>9600</u> / 19200 bps	
Data Length	<u>8</u> bits	
Stop Bit	<u>1</u> / 2 bits	
Parity	None / Odd / <u>Even</u>	
Target Port No.	<u>1</u> to 247	

PLC

Communication setting

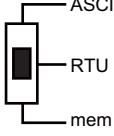
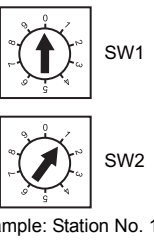
Switch	Setting	Contents	Remarks																				
	Communicati on setting	RTU	9600 bps, 8 bits, 1 bit, even (fixed)																				
	Device address	1 to 64	When the communication setting switch is set to "mem", the parameters set in the PLC programming software take effect. (Communication at 19200 bps maximum is allowed.) For more information, refer to the PLC manual issued by the manufacturer.																				
		<table border="1"> <thead> <tr> <th>Station No. (1 to 64)</th> <th>SW1 (the tens place)</th> <th>SW2 (the ones place)</th> </tr> </thead> <tbody> <tr> <td>1 to 9</td> <td>0</td> <td>1 to 9</td> </tr> <tr> <td>10 to 19</td> <td>1</td> <td rowspan="4">0 to 9</td> </tr> <tr> <td>20 to 29</td> <td>2</td> </tr> <tr> <td>30 to 39</td> <td>3</td> </tr> <tr> <td>40 to 49</td> <td>4</td> </tr> <tr> <td>50 to 59</td> <td>5</td> <td rowspan="2">0 to 4</td> </tr> <tr> <td>60 to 64</td> <td>6</td> </tr> </tbody> </table>	Station No. (1 to 64)	SW1 (the tens place)	SW2 (the ones place)	1 to 9	0	1 to 9	10 to 19	1	0 to 9	20 to 29	2	30 to 39	3	40 to 49	4	50 to 59	5	0 to 4	60 to 64	6	
Station No. (1 to 64)	SW1 (the tens place)	SW2 (the ones place)																					
1 to 9	0	1 to 9																					
10 to 19	1	0 to 9																					
20 to 29	2																						
30 to 39	3																						
40 to 49	4																						
50 to 59	5	0 to 4																					
60 to 64	6																						

Available Memory

The available memory setting range varies depending on the PLC model. Be sure to set within the range available for the PLC. Use [TYPE] when assigning the indirect memory for macro programs.

Memory	TYPE	Remarks
4 (holding register)	00H	
3 (input register)	01H	Read only
0 (output coil)	04H	
1 (input relay)	06H	Read only

Notes on Creating Screen Data

On the editor, the memory address is specified in decimal notation. Thus, when setting the address of the connected device that recognizes the memory address in hexadecimal notation, specify the value by converting the address into decimal one and add "1".

27.1.2 Wiring Diagrams

When Connected at COM2:

RS-232C

Wiring diagram 1 - COM2

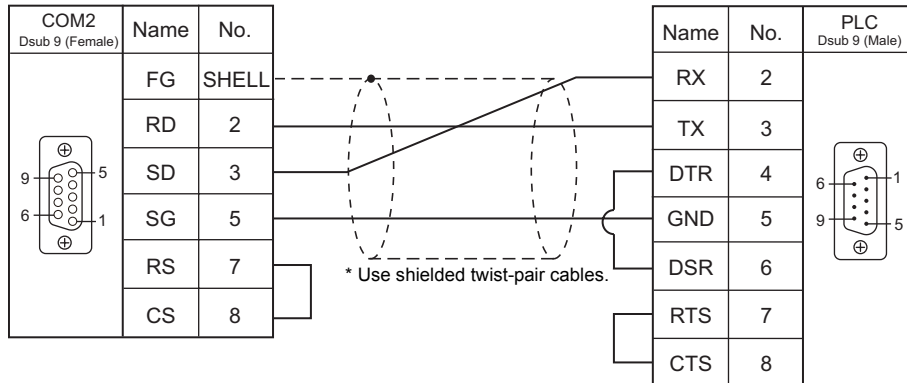

MEMO

Please use this page freely.

28. MOELLER

28.1 PLC Connection

28.1 PLC Connection

Serial Connection

PLC Selection on the Editor	CPU	Unit/Port	Signal Level	TS Port	Connection	Ladder Transfer *1
PS4	PS4-141-MM1 PS4-151-MM1 PS4-201-MM1 PS4-201-MM5 PS4-271-MM1 PS4-341-MM1	PRG port	RS-232C	COM2	Wiring diagram 1 - COM2	×
					MOELLER "ZB4-303-KB1" + Wiring diagram 2 - COM2	

*1 For the ladder transfer function, see "Appendix 5 Ladder Transfer Function".

28.1.1 PS4

Communication Setting

Editor

Communication setting

(Underlined setting: default)

Item	Setting	Remarks
Connection Mode	<u>1:1</u> / Multi-link2 / Multi-link2 (Ethernet)	
Signal Level	<u>RS-232C</u>	
Baud Rate	<u>9600 bps</u>	
Data Length	<u>8 bits</u>	
Stop Bit	<u>1 bit</u>	
Parity	<u>None</u>	

PLC

PRG port

The communication parameters are fixed; baud rate: 9600 bps, signal level: RS-232C, data length: 8 bits, stop bit: 1 bit, parity: none.

For establishing communication with the TS series, register a memory area in the PLC software "S40". For more information, refer to the PLC manual issued by the manufacturer.

Available Memory

The available memory setting range varies depending on the PLC model. Be sure to set within the range available for the PLC. Use [TYPE] when assigning the indirect memory for macro programs.

Memory	TYPE	Remarks
MW (Merker)	00H	M as bit device *1

*1 The assigned memory is indicated when editing the screen as shown below.

The addresses are expressed in "bytes". For word designation, specify an even-numbered address.

- Word device

Example: MW200

↑
Address number
(even number only)

- Bit device

Example: M200 : 0

↑ ↑
Bit number: 0 to 7
Period
Byte address number

Indirect Memory Designation

n+0	Model	Memory type
n+1	Address No. *1	
n+2	Expansion code	Bit designation *2
n+3	00	Station number

*1 Word designation

Specify an address number divided by "2".

Example: In the case of MW10, specify "5" (10 divided by 2) for the address number.

*2 Bit designation

Example: In the case of bits 0 to 7 of MW10, specify "5" for the address number and "0" to "7" for the bit designation.

Example: In the case of bits 0 to 7 of MW11, specify "5" for the address number and "8" to "15" for the bit designation.

28.1.2 Wiring Diagrams

When Connected at COM2:

RS-232C

Wiring diagram 1 - COM2

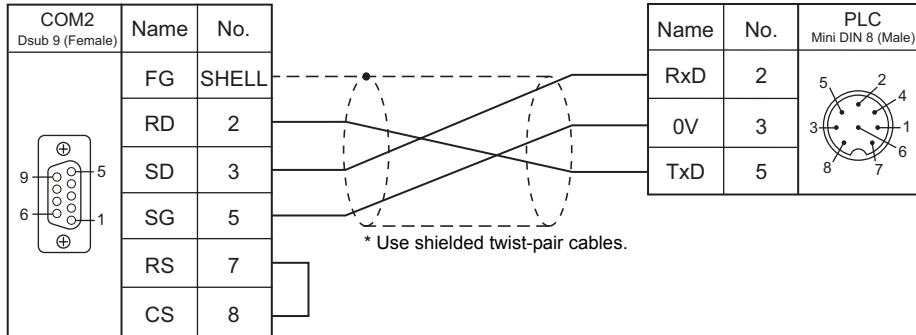

Wiring diagram 2 - COM2

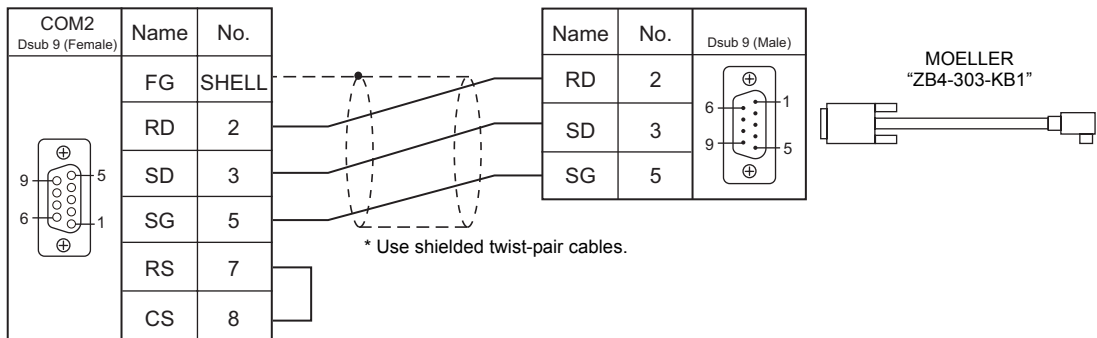

MEMO

Please use this page freely.

29. M-SYSTEM

29.1 Temperature Controller/Servo/Inverter Connection

29.1 Temperature Controller/Servo/Inverter Connection

Remote I/O

PLC Selection on the Editor	Model	Port	Signal Level	TS Port	Connection	Lst File
R1M series (MODBUS RTU)	R1M series	Dsub connector	RS-232C	COM2	Wiring diagram 1 - COM2	MSYS_R1M.Lst
		Terminal block	RS-485	COM1	Wiring diagram 1 - COM1	
				COM3	Wiring diagram 1 - COM3	

29.1.1 R1M Series

Communication Setting

Editor

Communication setting

(Underlined setting: default)

Item	Setting	Remarks
Connection Mode	1 : 1 / <u>1:n</u> / Multi-link2 / Multi-link2 (Ethernet) / 1 : n Multi-link2 (Ethernet)	
Signal Level	RS-232C / <u>RS-422/485</u>	
Baud Rate	9600 / 19200 / <u>38400</u> bps	
Data Length	8 bits	
Stop Bit	<u>1</u> / 2 bits	
Parity	None / <u>Odd</u> / Even	
Target Port No.	1 to 15	

Remote I/O

Make PLC settings by using the software "R1CON". For more information, refer to the PLC manual issued by the manufacturer.

Modbus Settings (RTU)

(Underlined setting: default)

Item	Setting	Remarks
Node Address	<u>1</u> to F H (= 1 to 15)	Set by the address setting rotary switch.
Baud Rate	9600 / 19200 / <u>38400</u> bps	
Bit Length	8 bits	
Parity	NONE / <u>ODD</u> / EVEN	
Stop Bit	<u>1</u> / 2 bits	

Available Memory

The available memory setting range varies depending on the device. Be sure to set within the range available with the device to be used. Use [TYPE] when assigning the indirect memory for macro programs.

Memory	TYPE	Remarks
0 (output coil)	00H	
1 (input relay)	01H	Read only
4 (holding register)	02H	
3 (input register)	03H	Read only

29.1.2 Wiring Diagrams

When Connected at COM1:

RS-485

Wiring diagram 1 - COM1

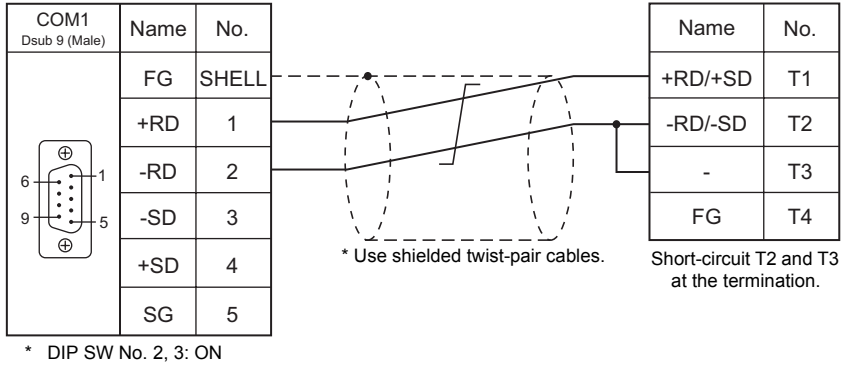

When Connected at COM2:

RS-232C

Wiring diagram 1 - COM2

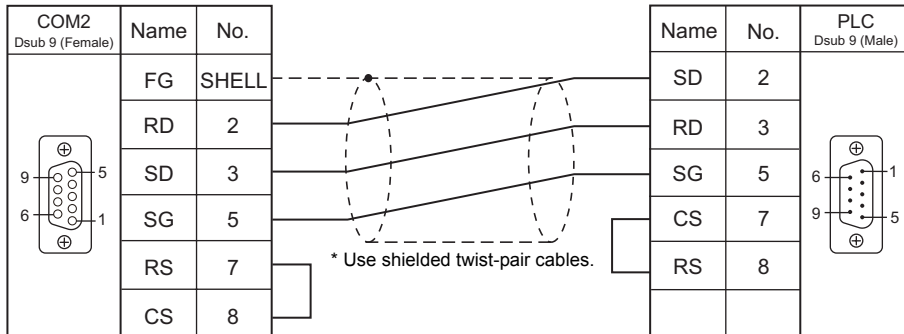

When Connected at COM3:

RS-485

Wiring diagram 1 - COM3

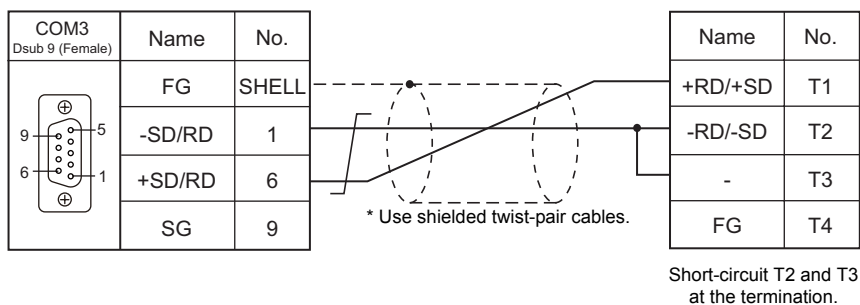

MEMO

Please use this page freely.

30. OMRON

30.1 PLC Connection

30.2 Temperature Controller/Servo/Inverter Connection

30.1 PLC Connection

Serial Connection

SYSMAC C/CV

PLC Selection on the Editor	CPU	Unit/Port	Signal Level	TS Port	Connection	Ladder Transfer *1
SYSMAC C	C20H,C28H,C40H	RS-232C port	RS-232C	COM2	Wiring diagram 1 - COM2	×
	C120, C120F C200H C500, C500F C1000H C2000, C2000H	C120-LK201-V1	RS-232C	COM2	Wiring diagram 3 - COM2	
		C120-LK202-V1	RS-422	COM1	Wiring diagram 1 - COM1	
	C200H C200HS-CPU01, 03 C200HS-CPU21, 23 C200HS-CPU31, 33	C200H-LK201	RS-232C	COM2	Wiring diagram 3 - COM2	
		C200H-LK202 C200H-LK202-V1	RS-422	COM1	Wiring diagram 1 - COM1	
	C200HS-CPU21, 23 C200HS-CPU31, 33 CQM1-CPU21 CQM1-CPU41, 42, 43, 44	RS-232C port	RS-232C	COM2	Hakko Electronics "D9-OM2-09" + Gender changer	
					Wiring diagram 2 - COM2	
	C500, C500F C1000H C2000, C2000H	C500-LK203	RS-232C	COM2	Wiring diagram 3 - COM2	
			RS-422	COM1	Wiring diagram 1 - COM1	
	C200HX C200HG C200HE	RS-232C port	RS-232C	COM2	Hakko Electronics "D9-OM2-09" + Gender changer	
		C200HW-COM02 C200HW-COM03 C200HW-COM04 C200HW-COM05 C200HW-COM06	RS-422	COM1	Wiring diagram 2 - COM1	
	SRM1-C02	RS-232C port	RS-232C	COM2	Hakko Electronics "D9-OM2-09" + Gender changer	
	CPM1A	Peripheral port	RS-232C	COM2	OMRON "CQM1-CIF02" + Wiring diagram 4 - COM2	
					Hakko Electronics "D9-OM2-09" + Gender changer	
CPM2A	RS-232C port	RS-232C	COM2	OMRON "CQM1-CIF02" + Wiring diagram 4 - COM2		
	Peripheral port	RS-232C	COM2	Hakko Electronics "D9-OM2-09" + Gender changer		
CPM2C	CS1W-CN118	RS-232C	COM2	Hakko Electronics "D9-OM2-09" + Gender changer		
	CPM2C-CIF01			Wiring diagram 2 - COM2		
	CPM2C-CIF11	RS-422	COM1	Wiring diagram 4 - COM1		
SYSMAC CV	CV500 CV1000 CV2000 CVM1	Host link port incorporated into CPU	RS-232C	COM2	Hakko Electronics "D9-OM2-09" + Gender changer	
					Wiring diagram 2 - COM2	
		CV500-LK201	RS-422	COM1	Wiring diagram 5 - COM1	
			RS-232C PORT1	COM2	Wiring diagram 3 - COM2	
			RS-232C PORT2	COM2	Hakko Electronics "D9-OM2-09" + Gender changer	
	RS-422	COM1	Wiring diagram 2 - COM1			

*1 For the ladder transfer function, see "Appendix 5 Ladder Transfer Function".

SYSMAC CS1/CJ1

PLC Selection on the Editor	CPU	Unit/Port	Signal Level	TS Port	Connection	Ladder Transfer *1	
SYSMAC CS1/CJ1 SYSMAC CS1/CJ1 DNA	CS1	RS-232C port	RS-232C	COM2	Hakko Electronics "D9-OM2-09" + Gender changer	○	
		CS1W-SCU21 CS1W-SCU21-V1			Wiring diagram 2 - COM2		
		CS1W-SCU31-V1	RS-422	COM1	Wiring diagram 3 - COM1		
		CS1W-SCB21 CS1W-SCB21-V1	RS-232C	COM2	Hakko Electronics "D9-OM2-09" + Gender changer		
		CS1W-SCB41 CS1W-SCB41-V1			Port 1		Wiring diagram 2 - COM2
		Port 2	RS-422	COM1	Wiring diagram 3 - COM1		
	CJ1H CJ1M	RS-232C port	RS-232C	COM2	Hakko Electronics "D9-OM2-09" + Gender changer		
		CJ1W-SCU21 CJ1W-SCU21-V1 CJ1W-SCU22			Wiring diagram 2 - COM2		
		CJ1W-SCU31-V1	RS-422	COM1	Wiring diagram 3 - COM1		
		CJ1W-SCU32	RS-422	COM1	Wiring diagram 4 - COM1		
			Port 1	RS-422	COM1		Wiring diagram 3 - COM1
		CJ1W-SCU41 CJ1W-SCU41-V1	RS-232C	COM2	Hakko Electronics "D9-OM2-09" + Gender changer		
					Port 2		Wiring diagram 2 - COM2
			Port 1	RS-422	COM1		Wiring diagram 4 - COM1
		CJ1W-SCU42	RS-232C	COM2	Hakko Electronics "D9-OM2-09" + Gender changer		
					Port 2		Wiring diagram 2 - COM2
	CJ2H CJ2M	RS-232C port *2	RS-232C	COM2	Hakko Electronics "D9-OM2-09" + Gender changer		
		CP1W-CIF01 *3			Wiring diagram 2 - COM2		
		CP1W-CIF11 *3 CP1W-CIF12 *3	RS-422	COM1	Wiring diagram 4 - COM1		
				COM3	Wiring diagram 1 - COM3		
		CJ1W-SCU21 CJ1W-SCU21-V1 CJ1W-SCU22	RS-232C	COM2	Hakko Electronics "D9-OM2-09" + Gender changer		
					Wiring diagram 2 - COM2		
		CJ1W-SCU31-V1	RS-422	COM1	Wiring diagram 3 - COM1		
		CJ1W-SCU32	RS-422	COM1	Wiring diagram 4 - COM1		
			Port 1	RS-422	COM1		Wiring diagram 3 - COM1
		CJ1W-SCU41 CJ1W-SCU41-V1	RS-232C	COM2	Hakko Electronics "D9-OM2-09" + Gender changer		
					Port 2		Wiring diagram 2 - COM2
			Port 1	RS-422	COM1		Wiring diagram 4 - COM1
		CJ1W-SCU42	RS-232C	COM2	Hakko Electronics "D9-OM2-09" + Gender changer		
					Port 2		Wiring diagram 2 - COM2
CP1E (N/NA) *4 CP1H CP1L		RS-232C port *5	RS-232C	COM2	Hakko Electronics "D9-OM2-09" + Gender changer		
	CP1W-CIF01	Wiring diagram 2 - COM2					
	CP1W-CIF11 CP1W-CIF12	RS-422	COM1	Wiring diagram 4 - COM1			
			COM3	Wiring diagram 1 - COM3			

*1 For the ladder transfer function, see "Appendix 5 Ladder Transfer Function".

*2 No built-in serial communication port is provided for CJ2M-3x.

*3 Can be used only with CJ2M-3x.

*4 CP1E (E type) cannot be connected because it is not equipped with a built-in serial communication port and the optional board cannot be installed on it.

*5 Only CP1E (N/NA type) is equipped with the built-in serial communication port.

Ethernet Connection

SYSMAC CS1/CJ1

PLC Selection on the Editor	CPU	Unit	TCP/IP	UDP/IP	Port No.	Ladder Transfer ^{*1}
SYSMAC CS1/CJ1 (Ethernet) SYSMAC CS1/CJ1 (Ethernet Auto) SYSMAC CS1/CJ1 DNA (Ethernet)	CS1	CS1W-ETN01 CS1W-ETN11 CS1W-ETN21	×	○	9600	×
	CJ1	CJ1W-ETN11 CJ1W-ETN21				

*1 For the ladder transfer function, see "Appendix 5 Ladder Transfer Function".

30.1.1 SYSMAC C

Communication Setting

Editor

Communication setting

(Underlined setting: default)

Item	Setting	Remarks
Connection Mode	<u>1</u> : 1 / 1 : n / Multi-link / Multi-link2	
Signal Level	<u>RS-232C</u> / RS-422/485	
Baud Rate	4800 / 9600 / <u>19200</u> bps	
Data Length	<u>7</u> / 8 bits	
Stop Bit	1 / <u>2</u> bits	
Parity	None / Odd / <u>Even</u>	
Target Port No.	<u>0</u> to 31	
Transmission Mode	<u>Transmission Mode 1</u> / Transmission Mode 2	Transmission Mode 1: BCD without signs Transmission Mode 2: BCD with signs

Transmission mode 2

When the transmission mode 2 (BCD with signs) is selected, data in the PLC memory can be displayed on TS series as data with signs.

When higher 4 bits in the memory indicates [F] or [A], it is treated as negative.

[F]: Regards higher 4 bits as [-0].

[A]: Regards higher 4 bits as [-1].

- Displayable range 1 word: -1999 to +9999
2 words: -19999999 to +99999999

Example:

PLC Memory	Indication on the TS series
0000 to 9999	0 to 9999
F001 to F999	-1 to -999
A000 to A999	-1000 to -1999
00000000 to 99999999	0 to 99999999
F0000001 to F9999999	-1 to -9999999
A0000000 to A9999999	-10000000 to -19999999

- Setting procedure: Num. Display [Input Type: BCD]
[Display Type: DEC] (w/ sign -, w/ sign +-)

PLC

C20H / C28H / C40H**Standard setting**

Item	Setting	Remarks
Start Bit	1 bit	Communication parameter format can be specified in the DM920 to DM923 memory. For more information, refer to the PLC manual issued by the manufacturer.
Data Length	7 bits	
Parity	Even	
Stop Bit	2 bits	
Baud Rate	9600 bps	

C120-LK201-V1 / C120-LK202-V1**Switch setting**

Switch	No.	Setting	Contents
SW1	1 to 5	OFF	Unit No. 0
	6 to 7	OFF	Not used
	8	ON	Starts operation at power-up
SW2	1	OFF	19200 bps
	2	OFF	
	3	ON	
	4	OFF	
	5	OFF	Not used
	6	OFF	1 : n protocol
	7	ON	Disables command levels 1, 2, and 3
	8	ON	
SW3	1	ON	CTS switch: always ON
	2	OFF	
	3	ON	LK201-V1: internal synchronization LK202-V1: terminating resistance provided
	4	OFF	
	5	ON	
	6	OFF	
	7 to 8	OFF	Not used

The communication parameter setting is fixed to 7 bits for data length, 2 bits for stop bit, and even for parity.

C200H-LK201-V1 / C200H-LK202-V1**Front switch setting**

Switch	Setting	Contents
SW1	0	Higher-order digit of the unit No. (×10)
SW2	0	Lower-order digit of the unit No. (×1)
SW3	6	19200 bps
SW4	2	Disables command levels 1, 2 and 3 / 7 / 2 / even

Back switch setting

Unit	Switch	Setting	Contents
LK201	SW1	OFF	Not used
	SW2	OFF	
	SW3	ON	1 : n protocol
	SW4	OFF	5-V power not supplied
	CTS switch	0	0 V (always ON)
LK202	Terminating resistance	ON	Provided
	Protocol	OFF	1 : n protocol

C500H-LK203

Back switch setting

Switch	Setting	Contents	
5-V power supply	OFF		
I/O port	-	RS-232C/RS422	
Synchronization	Internal		
Terminating resistance	Provided	Applicable for RS-422	
CTS	0V	0 V	
SW1	1 to 5	OFF	Unit No. 0
	6	OFF	7 / 2 / even
	7	OFF	
	8	ON	Monitor
SW2	1	OFF	19200 bps
	2	OFF	
	3	ON	
	4	OFF	
	5	ON	System No. 0
	6	OFF	1 : n protocol
	7	ON	Disables levels 1, 2, and 3
	8	ON	

C200HX / C200HG / C200HE

DIP switch

Item	Setting		Remarks
SW5	ON	Standard setting	7, 2, E, 9600 bps, Unit No. 0
	OFF	PC system setting	<p>Communication settings are made by setting DM6645 to 6648. For more information, refer to the PLC manual issued by the manufacturer.</p> <p>Setting example</p> <p>DM6645: "0001H" Communication is performed according to the setting for DM6646.</p> <p>DM6646: "0304H" 7, 2, E, 19200 bps</p> <p>DM6648: "0000H" Unit No. 0</p>

C200HW-COM02 - 06

DIP switch

For the port A of C200HW-CCM03/06 (RS-422), the DIP switch setting is available.

DIP Switch	Contents	Setting
SW1	Change-over of 2-wire or 4-wire system	4 (4-wire system)
SW2	Terminator	ON

PLC system setting

Item	Setting	Remarks
User Setting	Checked	The system setting can be made by specifying a value for the address using a programming console. For more information, refer to the PLC manual issued by the manufacturer.
Baud Rate	4800 / 9600 / 19200	
Parameter	1, 7, 2, E	
Mode	Host link	
Unit No.	00	

CPM2A

Communication condition setting switch

Communication Condition Setting Switch	Setting	Contents
	OFF	The peripheral port and RS-232C port are operated according to the communication protocol and communication format set on the PLC system setting.

PLC system setting

Item	Setting	Remarks
User Setting	Checked	The system setting can be made by specifying a value for the address using a programming console. For more information, refer to the PLC manual issued by the manufacturer.
Baud Rate	4800 / 9600 / 19200	
Parameter	1, 7, 2, E	
Mode	Host link	
Unit No.	00	

CPM1A/CPM2C

Communication port function setting switch (only for CPM2C)

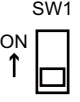
Communication Port Function Setting Switch	Setting	Contents
	OFF	The RS-232C port is operated according to the communication protocol and communication format set on the PLC system setting.

PLC system setting (peripheral port)

Item	Setting	Remarks
User Setting	Checked	The system setting can be made by specifying a value for the address using a programming console. For more information, refer to the PLC manual issued by the manufacturer.
Baud Rate	4800 / 9600 / 19200	
Parameter	1, 7, 2, E	
Mode	Host link	
Unit No.	00	

Available Memory

The available memory setting range varies depending on the PLC model. Be sure to set within the range available with the PLC to be used. Use [TYPE] when assigning the indirect memory for macro programs.

Memory	TYPE	Remarks
DM (data memory)	00H	
CH (input/output/internal auxiliary relay)	01H	
HR (holding relay)	02H	
LR (link relay)	03H	
AR (auxiliary memory relay)	04H	
T (timer/current value)	05H	
C (counter/current value)	06H	
EMn (extended data memory)	07H	*1
TU (timer/contact)	09H	Read only
CU (counter/contact)	0AH	Read only

*1 When using EMn (extended data memory), specify the bank number 0 to 7.
The assigned memory is indicated when editing the screen as shown on the right.

Example: EM0 : 30000

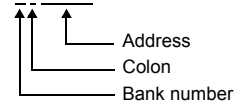

Indirect Memory Designation

- EMn (extended data memory)
Specify the bank number 0 to 7 in the expansion code.

30.1.2 SYSMAC CV

Communication Setting

Editor

Communication setting

(Underlined setting: default)

Item	Setting	Remarks
Connection Mode	<u>1</u> :1 / 1 : n / Multi-link / Multi-link2	
Signal Level	<u>RS-232C</u> / RS-422	
Baud Rate	4800 / 9600 / <u>19200</u> bps	
Data Length	<u>7</u> / 8 bits	
Stop Bit	1 / <u>2</u> bits	
Parity	None / Odd / <u>Even</u>	
Target Port No.	<u>0</u> to 31	
Transmission Mode	<u>Transmission Mode 1</u> / Transmission Mode 2	Transmission Mode 1: BCD without signs Transmission Mode 2: BCD with signs

Transmission mode 2

When the transmission mode 2 (BCD with signs) is selected, data in the PLC memory can be displayed on TS series as data with signs.

When higher 4 bits in the memory indicates [F] or [A], it is treated as negative.

[F]: Regards higher 4 bits as [-0].

[A]: Regards higher 4 bits as [-1].

- Displayable range 1 word: -1999 to +9999
2 words: -19999999 to +99999999

Example:

PLC Memory	Indication on the TS series
0000 to 9999	0 to 9999
F001 to F999	-1 to -999
A000 to A999	-1000 to -1999
00000000 to 99999999	0 to 99999999
F0000001 to F9999999	-1 to -9999999
A0000000 to A9999999	-10000000 to -19999999

- Setting procedure: Num. Display [Input Type: BCD]
[Display Type: DEC] (w/ sign -, w/ sign +-)

PLC

CPU Unit

Communication selector switch

Communication Selector Switch	Setting
	Upper: RS-232C Lower: RS-422

Basic setting DIP switch

DIP Switch		Setting	Remarks
	No. 3	OFF: Host link communication	
	No. 4	OFF: The host communication port is operated according to the communication condition set on the PLC system setting.	ON: Fixed to 9600 bps for baud rate, 0 for station number, 7 bits for data length, 2 bits for stop bit and even parity
	No. 6	ON: With terminating resistance	Invalid during RS-232C communication

PLC system setting (host link port)

Item	Setting	Remarks	
Port Setting	Default Setting	Unchecked	The system setting can be made by specifying a value for the address using a programming console. For more information, refer to the PLC manual issued by the manufacturer.
	Baud Rate	4800 / 9600 / 19200	
	Parameter	7, 2, E	
Unit No.	00		

Host Link Unit

Communication selector switch

Communication Selector Switch	Setting
	Communication port 2 Upper: RS-232C Lower: RS-422

Unit No. selector switch

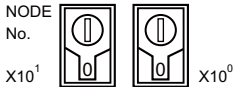
Unit No. Selector Switch	Setting
	Communication port 2 Unit No.: 00 to 31 (DEC)

Basic setting DIP switch

DIP Switch		Setting	Remarks
	No. 1	OFF: The link unit is operated according to the communication condition set on the CPU advanced unit system setting.	ON: Fixed to 9600 bps for baud rate, 0 for station number, 7 bits for data length, 2 bits for stop bit and even parity CPU fixed
	No. 2	ON: Switching CTS for communication port 1	
	No. 3	ON: Switching CTS for communication port 2	Invalid during RS-422 communication
	No. 4	OFF: Not used	
	No. 5	OFF: Normal operation	

CPU advanced unit system setting

Set parameters for communication port 1 or 2.

Available Memory

The available memory setting range varies depending on the PLC model. Be sure to set within the range available for the PLC. Use [TYPE] when assigning the indirect memory for macro programs.

Memory	TYPE	Remarks
DM (data memory)	00H	
CH (input/output/internal auxiliary relay)	01H	
AR (auxiliary memory relay)	04H	
T (timer/current value)	05H	
C (counter/current value)	06H	
EMn (extended data memory)	07H	*1
TU (timer/contact)	09H	Read only
CU (counter/contact)	0AH	Read only

*1 When using EMn (extended data memory), specify the bank number 0 to 7.
The assigned memory is indicated when editing the screen as shown on the right.

Example: EM0 : 30000

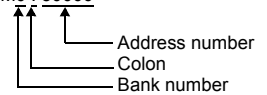

Indirect Memory Designation

- EMn (extended data memory)
Specify the bank number 0 to 7 in the expansion code.

30.1.3 SYSMAC CS1/CJ1

Communication Setting

Editor

Communication setting

(Underlined setting: default)

Item	Setting	Remarks
Connection Mode	<u>1</u> : 1 / 1 : n / Multi-link2	
Signal Level	<u>RS-232C</u> / RS-422/485	
Baud Rate	4800 / 9600 / <u>19200</u> / 38400 / 57600 / 115k bps	
Data Length	<u>7</u> / 8 bits	
Stop Bit	1 / <u>2</u> bits	
Parity	None / Odd / <u>Even</u>	
Target Port No.	<u>0</u> to 31	
Transmission Mode	<u>Transmission Mode 1</u> / Transmission Mode 2	Transmission Mode 1: BCD without signs Transmission Mode 2: BCD with signs

Transmission mode 2

When the transmission mode 2 (BCD with signs) is selected, data in the PLC memory can be displayed on TS series as data with signs.

When higher 4 bits in the memory indicates [F] or [A], it is treated as negative.

[F]: Regards higher 4 bits as [-0].

[A]: Regards higher 4 bits as [-1].

- Displayable range 1 word: -1999 to +9999
2 words: -19999999 to +99999999

Example:

PLC Memory	Indication on the TS series
0000 to 9999	0 to 9999
F001 to F999	-1 to -999
A000 to A999	-1000 to -1999
00000000 to 99999999	0 to 99999999
F0000001 to F9999999	-1 to -9999999
A0000000 to A9999999	-10000000 to -19999999

- Setting procedure: Num. Display [Input Type: BCD]
[Display Type: DEC] (w/ sign -, w/ sign +-)

PLC

CJ1/CS1/CJ2 (Built-in RS-232C Port / CP1W-CIFxx)

DIP switch

Switch	Contents	Setting
	SW1	User memory writing
	SW2	Automatic user program transfer at power-up
	SW3	CJ1/CJ2: Blank CS1: message of the programming console (Japanese/English)
	SW4	CJ2: Blank CS1/CJ1: peripheral port communication condition
	SW5	RS-232C communication setting
	SW6	User-specified switch
	SW7	Simple-backup type specification
	SW8	Fixed to OFF
		OFF: enabled OFF: not executed OFF OFF: CX-Programmer connection OFF: According to the setting made on the PLC system setting OFF OFF OFF

PC system setting

Item	Setting	Remarks
User Setting	Checked	The system setting can be made by specifying a value for the address using a programming console. For more information, refer to the PLC manual issued by the manufacturer.
Baud Rate	4800 / 9600 / 19200 / 38400 / 57600 / 115200	
Parameter	7, 2, E	
Mode	Host link	
Unit No.	00	

CP1W-CIF11/12 DIP switch

Make the operation setting for the RS-422/485 optional board (CP1W-CIF11/12) by using the DIP switch provided on the backside.

Switch	Contents	Setting
	SW1	Terminating resistance ON: Provided
	SW2	2-wire / 4-wire selection ON: 2-wire system OFF: 4-wire system
	SW3	2-wire / 4-wire selection ON: 2-wire system OFF: 4-wire system
	SW4	Not used OFF
	SW5	RS control for RD OFF: Without control
	SW6	RS control for SD ON: With control (when 2-wire system is selected) OFF: Without control (when 4-wire system is selected)

CJ1/CS1/CJ2 (Serial Communication Board/Unit)

Advanced unit setting

Item	Setting	Remarks
Random Setting	Provided	
Serial Communication Mode	Default (host link) / Host link	When "Default (host link)" is selected, the unit operates as the unit No. 0.
Data Length	7 bits / 8 bits	
Stop Bit	2 bits / 1 bit	
Parity	Even, odd, none	
Baud Rate	4800 / 9600 / 19200 / 38400 / 57600 / 115200	
Send Delay Time	Default: 0 ms	
Send Delay Time Random Setting	0	
CTS control	None	
Host link unit No.	00	

DM area setting

$m = D30000 + 100 \times \text{unit No. (CH)}$

DM Area				Bit	Contents	Setting
Board		Unit				
Port 1	Port 2	Port 1	Port 2			
D32000	D32010	m	m + 10	15	Port setting	1: Random setting
				14 to 12	Reserved	-
				11 to 08	Host link	0 or 5
				07 to 05	Reserved	-
				04	Start bit	0: 1 bit
				03	Data length	0: 7 bits 1: 8 bits
				02	Stop bit	0: 2 bits 1: 1 bit
				01	Parity	0: Provided 1: None
00	Parity	0: Even 1: Odd				

DM Area				Bit	Contents	Setting
Board		Unit				
Port 1	Port 2	Port 1	Port 2			
D32001	D32011	m + 1	m + 11	15 to 04	Reserved	-
				03 to 00	Baud rate	0: 9600 5: 4800 6: 9600 7: 19200 8: 38400 9: 57600 A: 115200
D32002	D32012	m + 2	m + 12	15	Send delay time	0: 0 ms 1: Random setting
				14 to 00	Send delay time random setting	0 to 7530H Unit: 10 ms
D32003	D32013	m + 3	m + 13	15	CTS control	0: None 1: Provided
				14	1 : n/1 : 1 protocol setting	1 : 1 : 1 protocol 0 : 1 : n protocol
				13 to 11	Reserved	-
				10 to 08	Host link-compatible model mode	
				07 to 00	Unit No.	00 to 1FH

CP1 (Built-in RS-232C Port / CP1W-CIFxx)

CPU DIP switch

Set the communication conditions for the CP1H/CP1L optional board slot by using the CPU DIP switch.

Switch	Contents	Setting
	SW4	Optional slot 1 communication condition
	SW5	Optional slot 2 communication condition
		OFF: According to the setting made on the PLC system setting
		OFF: According to the setting made on the PLC system setting

PLC system setting

Item	Setting	Remarks
User Setting	Checked	
Baud Rate	4800 / 9600 / 19200 / 38400 / 57600 / 115200	The system setting can be made by specifying a value for the address using a programming console. For more information, refer to the PLC manual issued by the manufacturer.
Parameter	7, 2, E	
Mode	Host link	
Unit No.	00 to 31	

CP1W-CIF11/12 DIP switch

Make the operation setting for the RS-422/485 optional board (CP1W-CIF11/12) by using the DIP switch provided on the backside.

Switch	Contents	Setting
	SW1	Terminating resistance
	SW2	2-wire / 4-wire selection
	SW3	2-wire / 4-wire selection
	SW4	Not used
	SW5	RS control for RD
	SW6	RS control for SD
		ON: Provided
		ON: 2-wire system OFF: 4-wire system
		ON: 2-wire system OFF: 4-wire system
		OFF
		OFF: Without control
		ON: With control (when 2-wire system is selected) OFF: Without control (when 4-wire system is selected)

Available Memory

The available memory setting range varies depending on the PLC model. Be sure to set within the range available with the PLC to be used. Use [TYPE] when assigning the indirect memory for macro programs.

Memory	TYPE	Remarks
DM (data memory)	00H	
CH (input/output/internal auxiliary relay)	01H	
H (holding relay)	02H	
A (auxiliary memory relay)	04H	
T (timer/current value)	05H	
C (counter/current value)	06H	
EMn (extended data memory)	07H	*1, not available on the CP1 series
W (internal relay)	08H	
TU (timer/contact)	09H	Read only
CU (counter/contact)	0AH	Read only

*1 When using EMn (extended data memory), specify the bank number 0 to 18 (HEX).
The assigned memory is indicated when editing the screen as shown on the right.

Example: EM0 : 30000

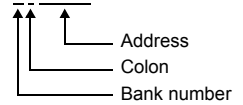

Indirect Memory Designation

- EMn (extended data memory)
Specify the bank number 0 to 18 (HEX) in the expansion code.

30.1.4 SYSMAC CS1/CJ1 (DNA)

The TS series can communicate with CS1/CJ1 on the network (Controller Link) via the serial unit.

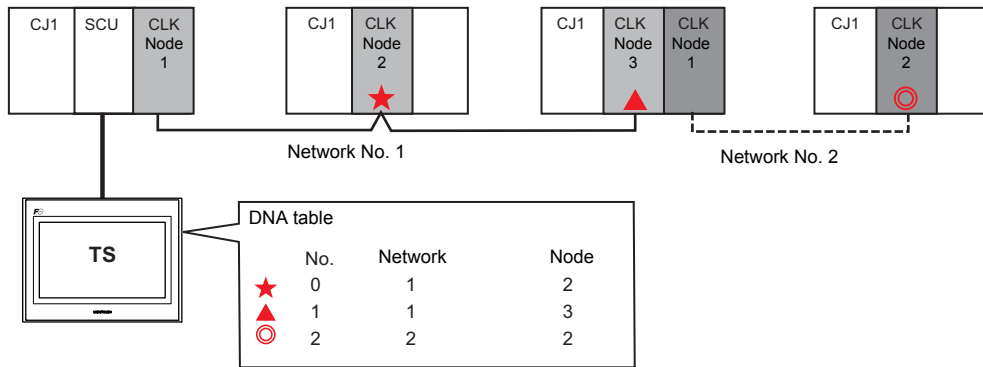

Communication Setting

Editor

Communication setting

The communication setting is the same as the one described in “30.1.3 SYSMAC CS1/CJ1”.

DNA

Valid only for 1 : 1 connection

Set the network number and node number of the PLC.

DNA	Set the network number of the communication target.
DA1	Set the node address of the communication target.

PLC

Communication setting

The communication setting is the same as the one described in “30.1.3 SYSMAC CS1/CJ1”.

CX-Integrator

Set the PLC routing table on “CX-Integrator”. Two types of routing tables are available: local network table and relay network table.

An error will occur unless these settings are made correctly. For more information, refer to the PLC manual issued by the manufacturer.

- Local network table
Set the unit number and network number of the communication unit.
- Relay network table
Set the network number of the access target (final network No.) and the first relay point (relay network No., relay node No.).

Rotary switch

NODE No.	Set the node number of the Controller Link unit.
----------	--

Available Memory

The available memory is the same as the one described in “30.1.3 SYSMAC CS1/CJ1”.

30.1.5 SYSMAC CS1/CJ1 (Ethernet)

Communication Setting

Editor

Make the following settings on the editor. For more information, see “Appendix 2 Ethernet”.

- IP address for the TS unit
 - When specified on the screen data:
[System Setting] → [Ethernet Communication] → [Local Port IP Address]
 - When specified on the TS unit
Main Menu screen → [Ethernet]
- Port number for the TS unit (for communication with PLC) and node address
[System Setting] → [Device Connection Setting] → [Communication Setting]

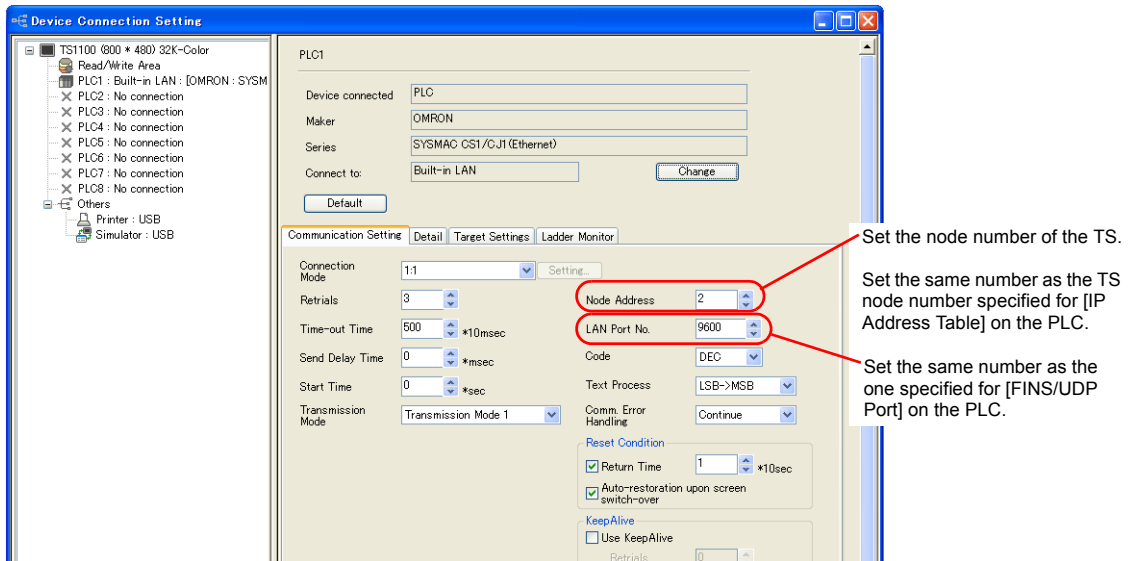

- IP address and port number of the PLC
[System Setting] → [Device Connection Setting] → [PLC Table]

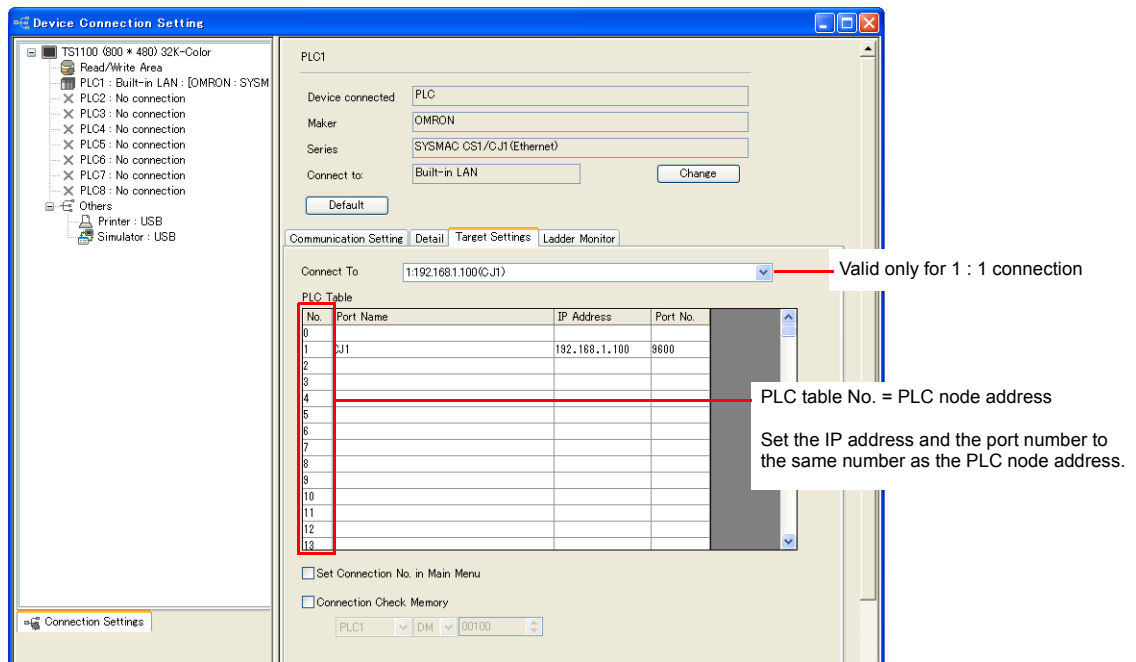

PLC

Make the following settings on CX Programmer. For more information, refer to the PLC manual issued by the manufacturer.

Parameter setting

IP Address	IP address of the PLC
Subnet Mask	Subnet mask of the PLC
IP Address Conversion	IP address table
IP Address Table	IP address and node number of the PLC IP address and node number of the TS
FINS/UDP Port	Default (9600)

Rotary switch

NODE No.	Set the FINS node number of the Ethernet unit. Match the node number to the one registered in the IP address table.
----------	--

Available Memory

The available memory setting range varies depending on the PLC model. Be sure to set within the range available with the PLC to be used. Use [TYPE] when assigning the indirect memory for macro programs.

Memory	TYPE	Remarks
DM (data memory)	00H	
CH (input/output/internal auxiliary relay)	01H	
H (holding relay)	02H	
A (auxiliary memory relay)	04H	
T (timer/current value)	05H	
C (counter/current value)	06H	
EMn (extended data memory)	07H	*1
W (internal relay)	08H	
TU (timer/contact)	09H	Read only
CU (counter/contact)	0AH	Read only

*1 When using EMn (extended data memory), specify the bank number 0 to C (HEX).
The assigned memory is indicated when editing the screen as shown on the right.

Example: EM0 : 30000

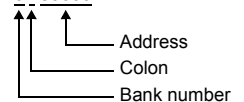

Indirect Memory Designation

- EMn (extended data memory)
Specify the bank number 0 to C (HEX) in the expansion code.

30.1.6 SYSMAC CS1/CJ1 (Ethernet Auto)

Communication Setting

Editor

Make the following settings on the editor. For more information, see “Appendix 2 Ethernet”.

- IP address for the TS unit
 - When specified on the screen data:
[System Setting] → [Ethernet Communication] → [Local Port IP Address]
 - When specified on the TS unit
Main Menu screen → [Ethernet]
- Port number for the TS unit (for communication with PLC)
[System Setting] → [Device Connection Setting] → [Communication Setting]

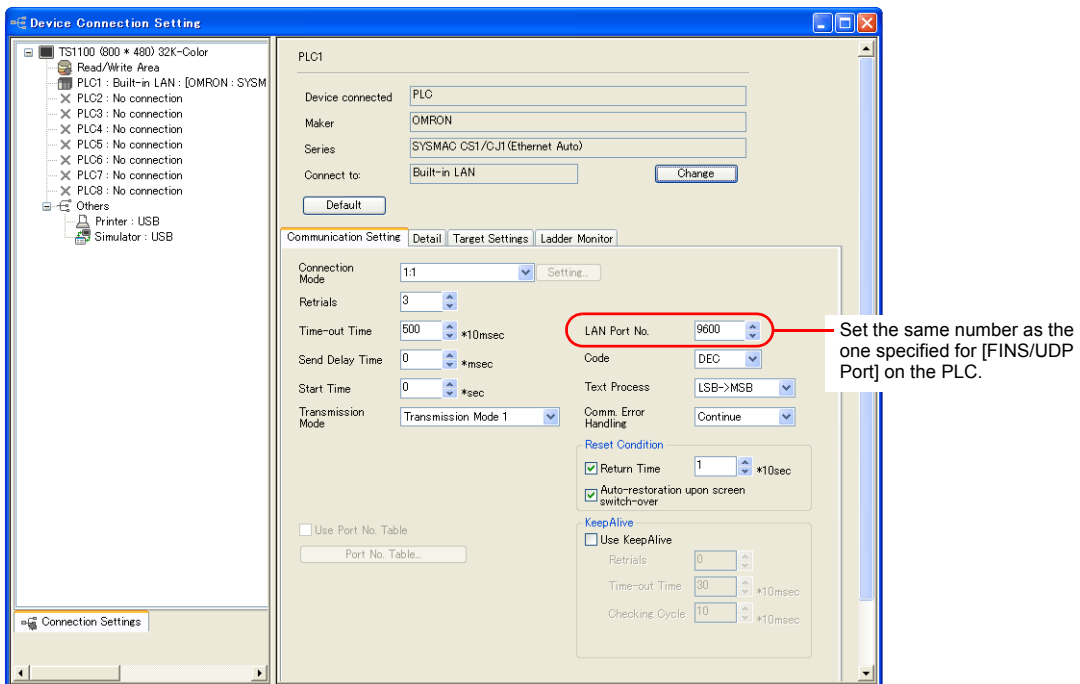

- IP address and port number of the PLC
[System Setting] → [Device Connection Setting] → [PLC Table]

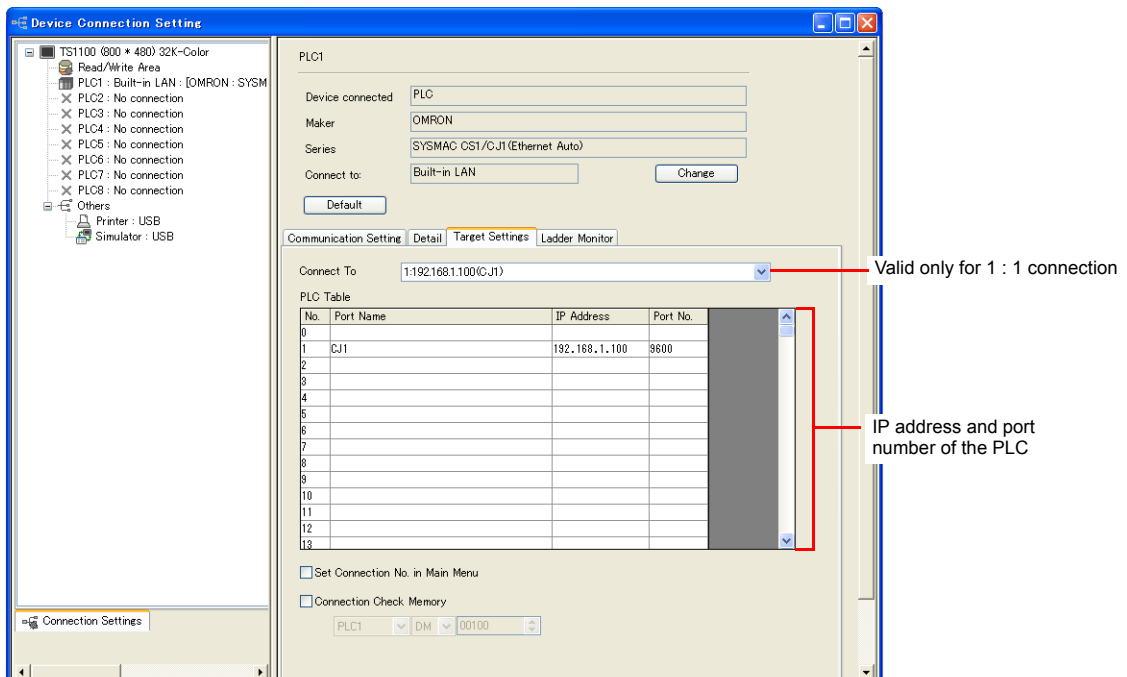

PLC

Make the following settings on CX Programmer. For more information, refer to the PLC manual issued by the manufacturer.

Parameter setting

IP Address (FINS node address)	IP address of the PLC Set the same number as the node number of the rotary switch for the lowest byte which is to be the FINS node address.
Subnet Mask	Subnet mask of the PLC
IP Address Conversion	Automatic generation (dynamic)
FINS/UDP Port	Default (9600)

Rotary switch

NODE No.	Set the FINS node number of the Ethernet unit. Match the node number to the lower byte of the IP address.
----------	--

Available Memory

The available memory setting range varies depending on the PLC model. Be sure to set within the range available with the PLC to be used. Use [TYPE] when assigning the indirect memory for macro programs.

Memory	TYPE	Remarks
DM (data memory)	00H	
CH (input/output/internal auxiliary relay)	01H	
H (holding relay)	02H	
A (auxiliary memory relay)	04H	
T (timer/current value)	05H	
C (counter/current value)	06H	
EMn (extended data memory)	07H	*1
W (internal relay)	08H	
TU (timer/contact)	09H	Read only
CU (counter/contact)	0AH	Read only

*1 When using EMn (extended data memory), specify the bank number 0 to C (HEX).
The assigned memory is indicated when editing the screen as shown on the right.

example: EM0 : 30000

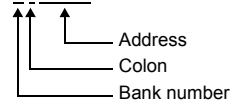

Indirect Memory Designation

- EMn (extended data memory)
Specify the bank number 0 to C (HEX) in the expansion code.

30.1.7 SYSMAC CS1/CJ1 DNA (Ethernet)

The TS series can communicate with CS1/CJ1 on the network (Controller Link) via the Ethernet unit.

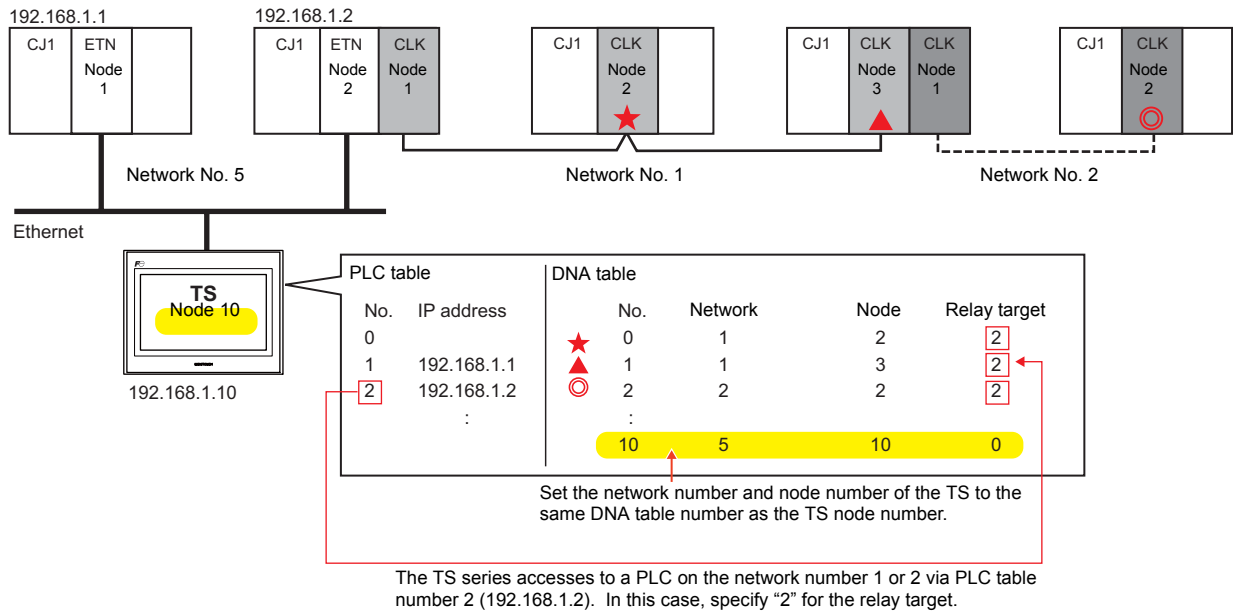

Communication Setting

Editor

Make the following settings on the editor. For more information, see "Appendix 2 Ethernet".

- IP address for the TS unit
 - When specified on the screen data: [System Setting] → [Ethernet Communication] → [Local Port IP Address]
 - When specified on the TS unit: Main Menu screen → [Ethernet]
- Port number (for communication with PLC) and local port number (TS DNA table number) of the TS unit: [System Setting] → [Device Connection Setting] → [Communication Setting]

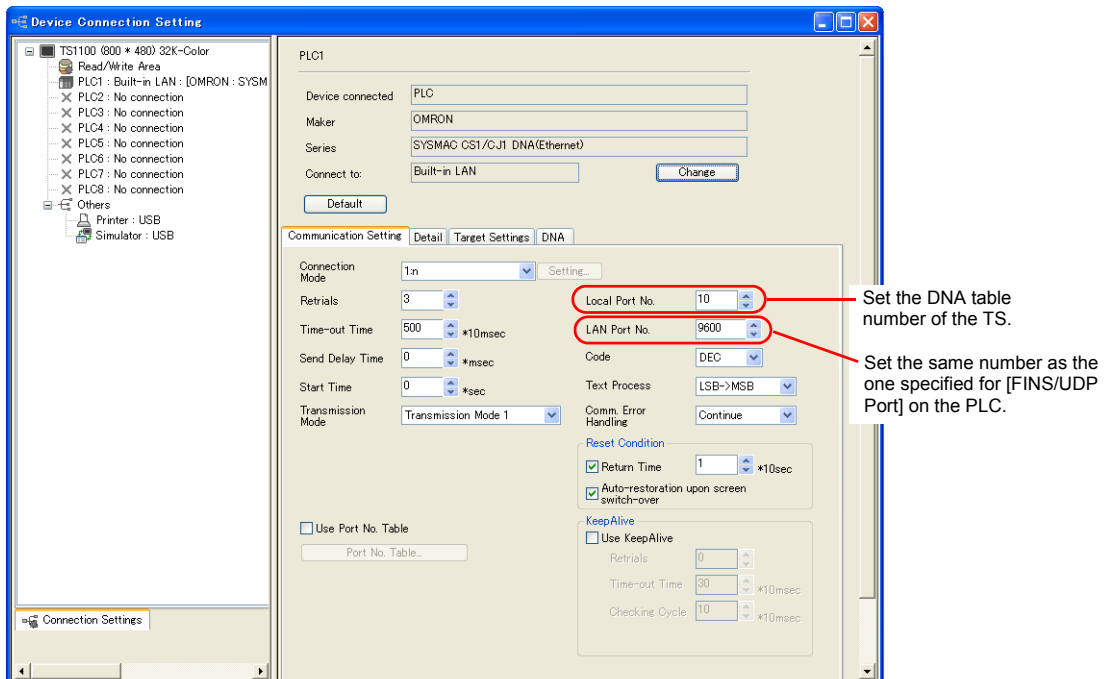

- IP address and port number of the PLC
[System Setting] → [Device Connection Setting] → [PLC Table]

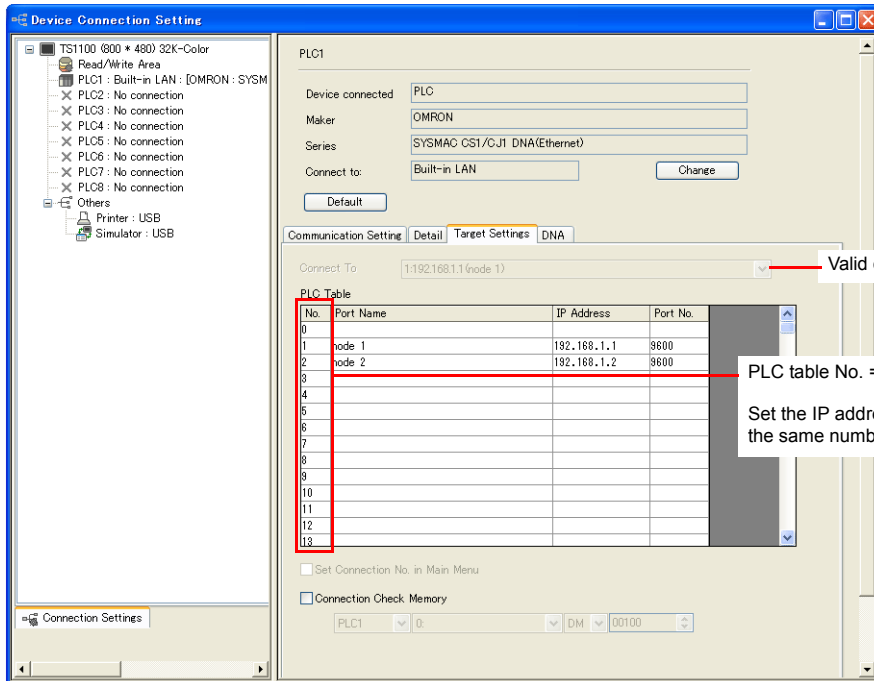

- Network number and node number of the PLC, PLC table number of the relay PLC
Network number and node number of the TS
[System Setting] → [Device Connection Setting] → [DNA]

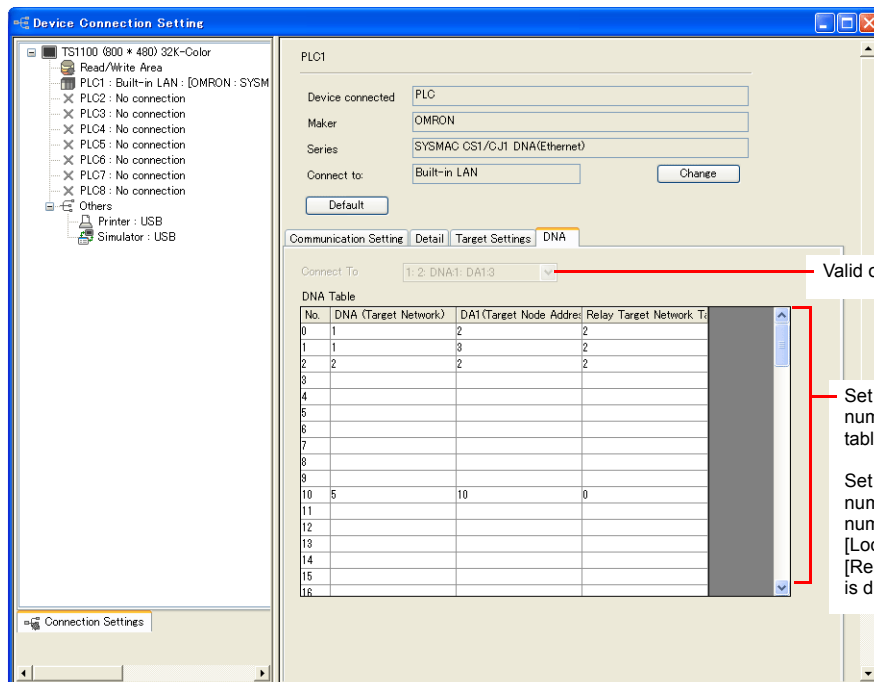

PLC

Communication setting

Make the following settings on CX Programmer. For more information, refer to the PLC manual issued by the manufacturer.

Parameter setting

IP Address	IP address of the PLC
Subnet Mask	Subnet mask of the PLC
IP Address Conversion	IP address table
IP Address Table	IP address and node number of the PLC IP address and node number of the TS
FINS/UDP Port	Default (9600)

Rotary switch

NODE No.	Set the node number of the Ethernet unit or Controller Link unit.
----------	---

CX-Integrator

Set the PLC routing table on "CX-Integrator". Two types of routing tables are available: local network table and relay network table.

An error will occur unless these settings are made correctly. For more information, refer to the PLC manual issued by the manufacturer.

- Local network table
Set the unit number and network number of the communication unit.
- Relay network table
Set the network number of the access target (final network No.) and the first relay point (relay network No., relay node No.).

Available Memory

The available memory is the same as the one described in "30.1.5 SYSMAC CS1/CJ1 (Ethernet)".

30.1.8 Wiring Diagrams

When Connected at COM1:

RS-422

Wiring diagram 1 - COM1

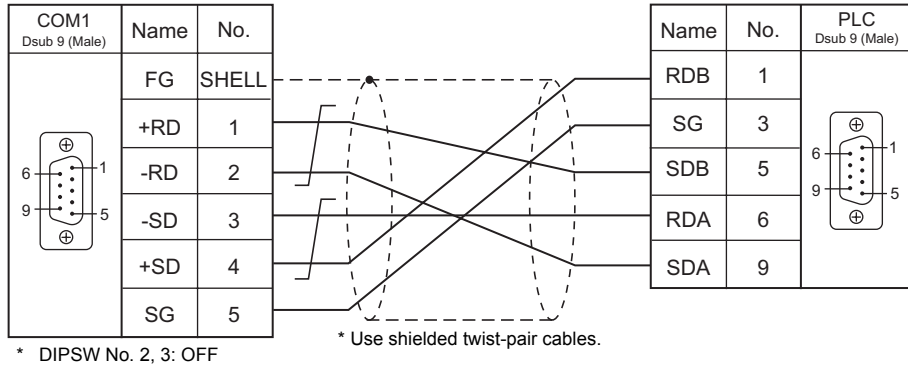

Wiring diagram 2 - COM1

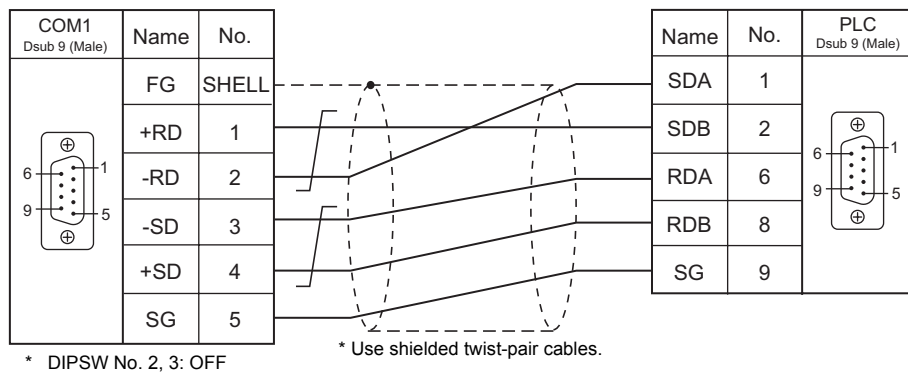

Wiring diagram 3 - COM1

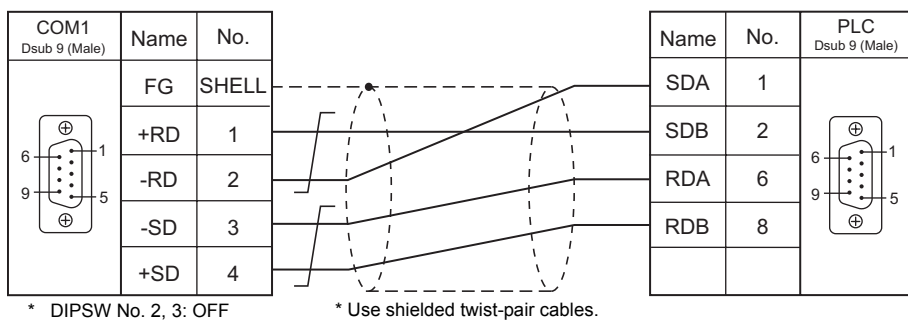

Wiring diagram 4 - COM1

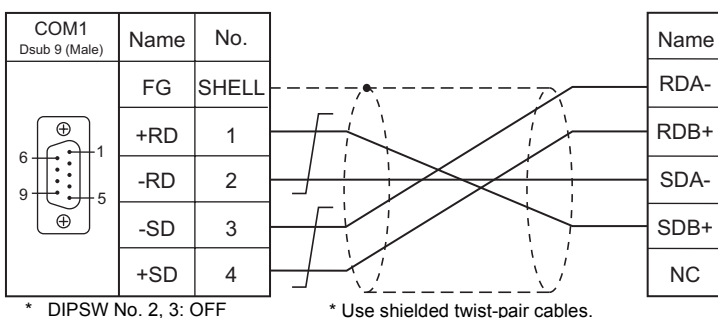

Wiring diagram 5 - COM1

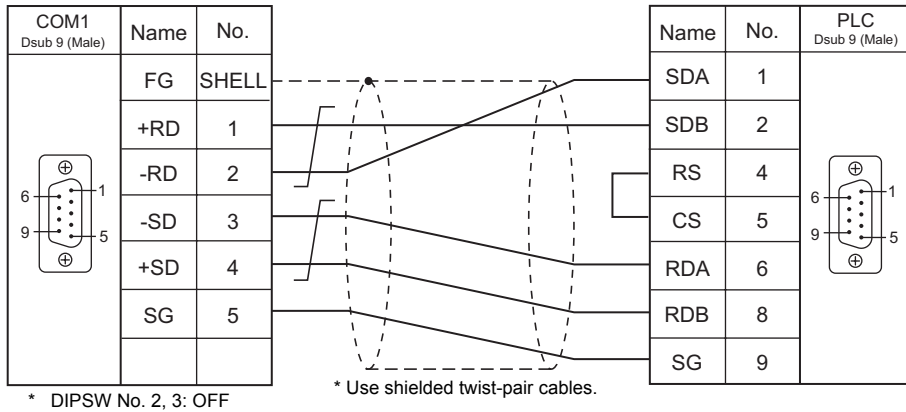

When Connected at COM2:

RS-232C

Wiring diagram 1 - COM2

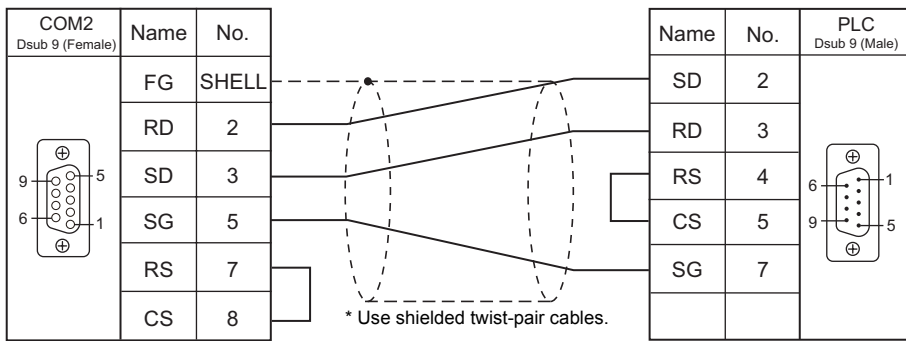

Wiring diagram 2 - COM2

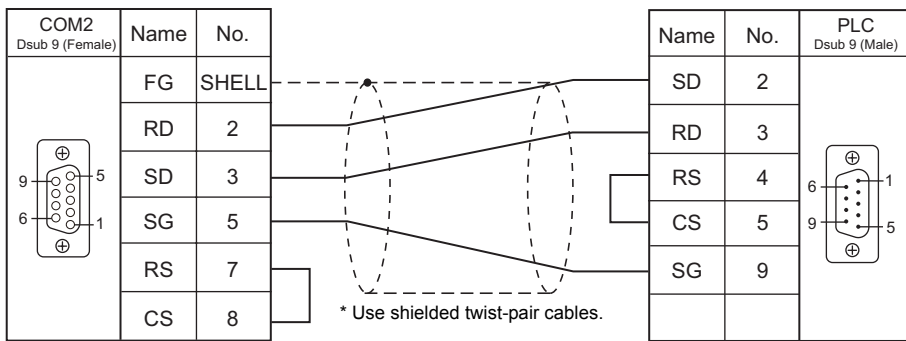

Wiring diagram 3 - COM2

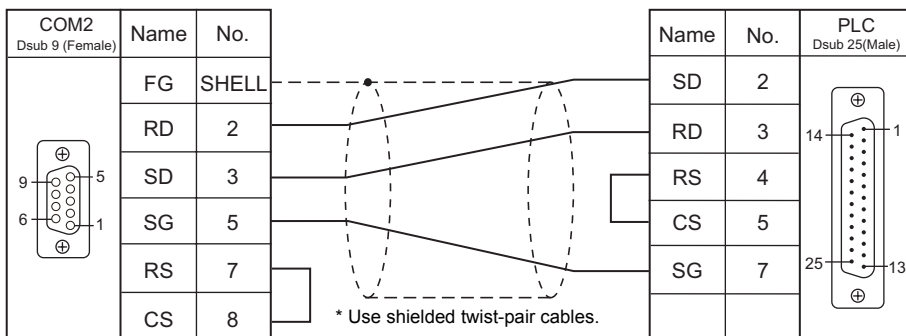

Wiring diagram 4 - COM2

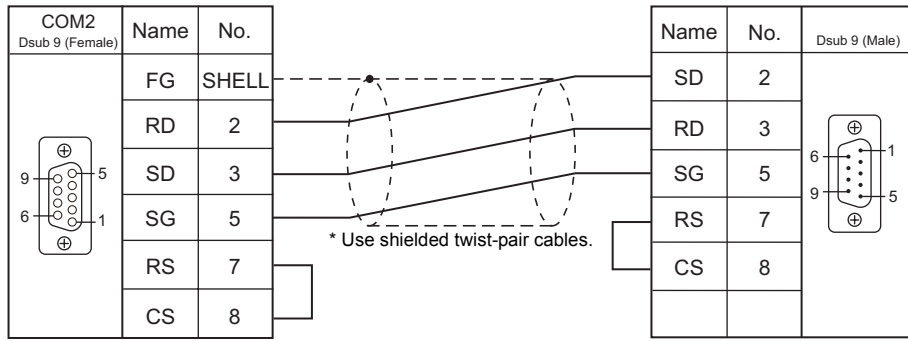

When Connected at COM3:

RS-485

Wiring diagram 1 - COM3

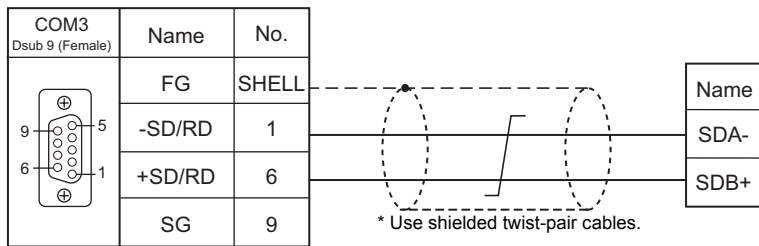

30.2 Temperature Controller/Servo/Inverter Connection

The controller models shown below can be connected.

Temperature Controller

PLC Selection on the Editor	Model	Port	Signal Level	TS Port	Connection	Lst File
E5AK	E5AK-xxx01xx	Terminal	RS-232C	COM2	Wiring diagram 1 - COM2	E5AK.Lst
	E5AK-xxx02xx	Terminal	RS-422	COM1	Wiring diagram 2 - COM1	
	E5AK-xxx03xx	Terminal	RS-485	COM1	Wiring diagram 3 - COM1	
COM3				Wiring diagram 2 - COM3		
E5AK-T	E5AK-Txx01xx	Terminal	RS-232C	COM2	Wiring diagram 1 - COM2	E5AKT.Lst
	E5AK-Txx02xx	Terminal	RS-422	COM1	Wiring diagram 2 - COM1	
	E5AK-Txx03xx	Terminal	RS-485	COM1	Wiring diagram 3 - COM1	
COM3				Wiring diagram 2 - COM3		
E5AN/E5EN/E5CN/ E5GN	E5AN-xxxx01xxxxFLK E5EN-xxxx01xxxxFLK	Terminal	RS-232C	COM2	Wiring diagram 1 - COM2	E5AN.Lst
	E5CN-xxxx03xxxxFLK E5AN-xxxx03xxxxFLK E5EN-xxxx03xxxxFLK E5GN-xx03x-FLK	Terminal	RS-485	COM1	Wiring diagram 1 - COM1	
				COM3	Wiring diagram 1 - COM3	
E5AR/E5ER	E5AR-xxxxxxxx-FLK E5ER-xxxxxxxx-FLK	Terminal	RS-485	COM1	Wiring diagram 1 - COM1	E5AR.Lst
				COM3	Wiring diagram 1 - COM3	
E5CK	E5CK-xxx01	Terminal	RS-232C	COM2	Wiring diagram 1 - COM2	E5CK.Lst
	E5CK-xxx03	Terminal	RS-485	COM1	Wiring diagram 1 - COM1	
				COM3	Wiring diagram 1 - COM3	
	E5CK-Txx01	Terminal	RS-232C	COM2	Wiring diagram 1 - COM2	
E5CK-Txx03				Terminal	RS-485	COM1
						COM3
E5CN-HT	E5CN-HTxxx01xx-x-FLK E5AN-HTxxx01Bxx-x-FLK E5EN-HTxxx01Bxx-x-FLK	Terminal	RS-232C	COM2	Wiring diagram 1 - COM2	E5CN-HT.Lst
	E5AN-HTxxx02Bxx-x-FLK E5EN-HTxxx02Bxx-x-FLK	Terminal	RS-422	COM1	Wiring diagram 2 - COM1	
				COM1	Wiring diagram 1 - COM1	
	E5CN-HTxxx03xx-x-FLK E5AN-HTxxx03Bxx-x-FLK E5EN-HTxxx03Bxx-x-FLK	Terminal	RS-485	COM3	Wiring diagram 1 - COM3	
E5EK	E5EK-xxx01xx	Terminal	RS-232C	COM2	Wiring diagram 1 - COM2	E5EK.Lst
	E5EK-xxx02xx	Terminal	RS-422	COM1	Wiring diagram 2 - COM1	
	E5EK-xxx03xx	Terminal	RS-485	COM1	Wiring diagram 3 - COM1	
COM3				Wiring diagram 2 - COM3		
E5ZD	E5ZD-4xx01xx E5ZD-6xx01xx	CN4	RS-232C	COM2	Wiring diagram 2 - COM2	E5ZD.Lst
	E5ZD-8xx01xx	CN501				
	E5ZD-4xx02xx E5ZD-6xx02xx	CN6	RS-422	COM1	Wiring diagram 4 - COM1	
				COM1	Wiring diagram 2 - COM1	
	E5ZD-8xx02xx	CN502 TB302	RS-485	COM1	Wiring diagram 5 - COM1	
				COM3	Wiring diagram 3 - COM3	
	E5ZD-4xx03xx E5ZD-6xx03xx	CN6	RS-485	COM1	Wiring diagram 5 - COM1	
				COM3	Wiring diagram 3 - COM3	
E5ZD-8xx03xx	CN502 TB302	RS-485	COM1	Wiring diagram 5 - COM1		
			COM3	Wiring diagram 3 - COM3		
E5ZE	E5ZE-8xxx01xx	-	RS-232C	COM2	Wiring diagram 2 - COM2	E5ZE.Lst
	E5ZE-8xxx04xx	Terminal	RS-422/485	COM1	Wiring diagram 2 - COM1	
E5ZN	E5ZN	Terminal	RS-485	COM1	Wiring diagram 1 - COM1	E5ZN.Lst
				COM3	Wiring diagram 1 - COM3	

ID Controller

PLC Selection on the Editor	Model	Port	Signal Level	TS Port	Connection	Lst File
V600/620/680	V600-CA1A-V	Dsub25	RS-232C	COM2	Wiring diagram 2 - COM2	OM_V600.Lst
	V600-CA2A-V	Dsub9	RS-485	COM1	Wiring diagram 4 - COM1	
				COM3	Wiring diagram 4 - COM3	
	V600-CD1D	Dsub9	RS-232C	COM2	Wiring diagram 3 - COM2	
				Terminal	RS-485	
	V680-CA5D01-V2 V680-CA5D02-V2	Terminal	RS-485		COM3	

Power Meter

PLC Selection on the Editor	Model	Port	Signal Level	TS Port	Connection	Lst File
KM20	KM20-B40-FLK	Terminal	RS-485	COM1	Wiring diagram 1 - COM1	OM_KM20.Lst
				COM3	Wiring diagram 1 - COM3	
		K3SC terminal	RS-232C	COM2	Wiring diagram 4 - COM2	
KM100	KM100-Tx-FLK	Terminal	RS-485	COM1	Wiring diagram 1 - COM1	OM_KM100.Lst
				COM3	Wiring diagram 1 - COM3	
		K3SC terminal	RS-232C	COM2	Wiring diagram 4 - COM2	

30.2.1 E5AK

Communication Setting

Editor

Communication setting

(Underlined setting: default)

Item	Setting	Remarks
Connection Mode	1 : 1 / <u>1:n</u> / Multi-link2 / Multi-link2 (Ethernet)	
Signal Level	RS-232C / <u>RS-422/485</u>	
Baud Rate	4800 / <u>9600</u> / 19200 bps	
Data Length	<u>7</u> / 8 bits	
Stop Bit	1 / <u>2</u> bits	
Parity	None / Odd / <u>Even</u>	
Target Port No.	<u>0</u> to 31	

Temperature Controller

(Underlined setting: default)

Mode	Displayed Character	Setting Data	Setting
Option mode	Sbit	Stop bit	1 / <u>2</u> bits
	LEn	Data length	<u>7</u> / 8 bits
	PrtY	Parity	None / Odd / <u>Even</u>
	bPS	Baud rate	4800 / <u>9600</u> / 19200 bps
	U-no	Communication unit No.	<u>0</u> to 31

Available Memory

The available memory setting range varies depending on the PLC model. Be sure to set within the range available for the PLC. Use [TYPE] when assigning the indirect memory for macro programs.

Memory	TYPE	Remarks
D (parameter)	00H	
S (special command)	01H	S00 to 11 Write only, expansion code: fixed to 0
		S14 Read only, expansion code 0: group A / 1: group B

Indirect Memory Designation

	15	8 7	0
n + 0	Model (91 to 98)	Memory type	
n + 1	Address No.		
n + 2	Expansion code	Bit designation	
n + 3	00	Station number	

When monitoring special command S14 (status), specify the group number in the expansion code.

00H: Group A

01H: Group B

30.2.2 E5AK-T

Communication Setting

Editor

Communication setting

(Underlined setting: default)

Item	Setting	Remarks
Connection Mode	1 : 1 / <u>1:n</u> / Multi-link2 / Multi-link2 (Ethernet) / 1 : n Multi-link2 (Ethernet)	
Signal Level	RS-232C / <u>RS-422/485</u>	
Baud Rate	4800 / <u>9600</u> / 19200 bps	
Data Length	<u>7</u> / 8 bits	
Stop Bit	1 / <u>2</u> bits	
Parity	None / Odd / <u>Even</u>	
Target Port No.	<u>0</u> to 99	

Temperature Controller

(Underlined setting: default)

Mode	Displayed Character	Setting Data	Setting
Option mode	Sbit	Stop bit	1 / <u>2</u> bits
	LEn	Data length	<u>7</u> / 8 bits
	PrtY	Parity	None / Odd / <u>Even</u>
	bPS	Baud rate	4800 / <u>9600</u> / 19200 bps
	U-no	Communication unit No.	<u>0</u> to 99

Available Memory

The available memory setting range varies depending on the PLC model. Be sure to set within the range available for the PLC. Use [TYPE] when assigning the indirect memory for macro programs.

Memory	TYPE	Remarks
D (parameter)	00H	
S (special command)	01H	S00 to 11 Write only, expansion code: fixed to 0
		S14 Read only, expansion code 0: group A / 1: group B
P (program parameter)	02H	

Indirect Memory Designation

	15	8 7	0
n+0	Model (91 to 98)	Memory type	
n+1	Address No.		
n+2	Expansion code	Bit designation	
n+3	00	Station number	

When monitoring special command S14 (status), specify the group number in the expansion code.

00H: Group A

01H: Group B

30.2.3 E5AN/E5EN/E5CN/E5GN

Communication Setting

Editor

Communication setting

(Underlined setting: default)

Item	Setting	Remarks
Connection Mode	1 : 1 / <u>1-n</u> / Multi-link2	
Signal Level	RS-232C / <u>RS-422/485</u>	
Baud Rate	4800 / <u>9600</u> / 19200 / 38400 / 57600 bps	
Data Length	<u>7</u> / 8 bits	
Stop Bit	1 / <u>2</u> bits	
Parity	None / Odd / <u>Even</u>	
Target Port No.	0 to 31	

Temperature Controller

E5CN/E5SAN/E5EN

Communication level setting

(Underlined setting: default)

Level	Displayed Character	Setting Data	Setting
Communication level	PSEL	Protocol selection	CompoWay/F
	U-no	Communication unit No.	0 to 31
	bps	Baud rate	4800 / <u>9600</u> / 19200 / 38400 / 57600 bps
	LEn	Data length	<u>7</u> / 8 bits
	Sbit	Communication stop bit	1 / <u>2</u> bits
	Prty	Parity	None / Odd / <u>Even</u>
Adjustment level	CMWT	Communication writing ^{*1}	OFF / ON

*1 When writing setting data from the TS, set "ON" for the "communication writing" setting.

E5GN

Communication level setting

(Underlined setting: default)

Level	Displayed Character	Setting Data	Setting
Communication level	U-no	Communication unit No.	0 to 31
	bps	Baud rate	4800 / <u>9600</u> / 19200 bps
	LEn	Data length	<u>7</u> / 8 bits
	Sbit	Communication stop bit	1 / <u>2</u> bits
	Prty	Parity	None / Odd / <u>Even</u>
Adjustment level	CMWT	Communication writing ^{*1}	OFF / ON

*1 When writing setting data from the TS, set "ON" for the "communication writing" setting.

Available Memory

The available memory setting range varies depending on the PLC model. Be sure to set within the range available for the PLC. Use [TYPE] when assigning the indirect memory for macro programs.

Memory	TYPE	Remarks
C0 (setting area 0)	00H	Double-word, read only
C1 (setting area 0)	01H	Double-word
C3 (setting area 1)	03H	Double-word

Indirect Memory Designation

	15	8 7	0
n + 0	Model (91 to 98)	Memory type	
n + 1	Address No.		
n + 2	Expansion code	Bit designation	
n + 3	00	Station number	

For bit designation, an expansion code setting is required.

- 00H: when designating bit 0 to 15
- 01H: when designating bit 16 to 31

PLC_CTL

Macro command "PLC_CTL F0 F1 F2"

Contents	F0	F1 (= \$u n)	F2									
Read controller status	1 - 8 (PLC1 - 8)	n	Station number									
		n + 1	Command: 0006H									
		n + 2	Operation status (higher byte) 00: Control in execution (Operation in progress while the setting area is "0" with no error occurring) 01: Control not in execution (Other than above) Related information (lower byte) Bit <table border="1" style="display: inline-table; vertical-align: middle;"> <tr> <td>-</td><td>7</td><td>6</td><td>5</td><td>4</td><td>3</td><td>2</td><td>1</td><td>0</td> </tr> </table> <ul style="list-style-type: none"> Input error Beyond the display range Heater overcurrent (CT1) Heater current hold (CT1) A/D converter error Heater overcurrent (CT2) Heater current hold (CT2) 	-	7	6	5	4	3	2	1	0
-	7	6	5	4	3	2	1	0				
Operation instructions	1 - 8 (PLC1 - 8)	n	Station number *1									
		n + 1	Command: 0030H									
		n + 2	Communication writing 0000H: Communication writing OFF (disabled) 0001H: Communication writing ON (enabled)									
			Control start/stop 0100H: Channel 1 Run 0101H: Channel 1 Stop									
			Multi-SP 0200H: Target value 1 0201H: Target value 2 0202H: Target value 3 0203H: Target value 4									
			AT execution/cancel 0300H: Cancel 0301H: Execute									
			Write mode 0400H: Backup mode 0401H: RAM write mode									
			0500H: Save RAM data									
			0600H: Software reset									
			0700H: Move to set area 1									
0800H: Move to protect level												

Return data: Data stored from temperature controller to TS series

*1 8000 (HEX): broadcasting

30.2.4 E5AR/E5ER

Communication Setting

Editor

Communication setting

(Underlined setting: default)

Item	Setting	Remarks
Connection Mode	1 : 1 / <u>1-n</u> / Multi-link2	
Signal Level	RS-422/485	
Baud Rate	<u>9600</u> / 19200 / 38400 bps	
Data Length	<u>7</u> / 8 bits	
Stop Bit	1 / <u>2</u> bits	
Parity	None / Odd / <u>Even</u>	
Target Port No.	<u>0</u> to 31	

Temperature Controller

Communication level setting (LS)

(Underlined setting: default)

Level	Displayed Character	Setting Data	Setting
Communication level (L.S)	PSEL	Protocol selection	CompoWay/F
	U-no	Communication unit No.	0 to 31
	bps	Baud rate	<u>9600</u> / 19200 / 38400 bps
	LEn	Communication data length	<u>7</u> / 8 bits
	Sbit	Communication stop bit	1 / <u>2</u> bits
Adjustment level (L.Adj)	Prty	Communication parity	None / Odd / <u>Even</u>
	CMWT	Communication writing*1	OFF / ON

*1 When writing setting data from the TS, set "ON" for the "communication writing" setting.

Available Memory

The available memory setting range varies depending on the PLC model. Be sure to set within the range available with the PLC to be used. Use [TYPE] when assigning the indirect memory for macro programs.

Memory	TYPE	Remarks
C0 (communication monitor)	00H	Double-word
C1 (communication monitor)	01H	Double-word
C4 (communication monitor)	03H	Double-word
C5 (protection level)	04H	Double-word
C6 (run level)	05H	Double-word
C7 (adjustment level)	06H	Double-word
C8 (adjustment 2 level)	07H	Double-word
C9 (bank setting level)	08H	Double-word
CA (PID setting level)	09H	Double-word
CB (approximation setting level)	0AH	Double-word
CC (default setting level for input)	0BH	Double-word
CD (default setting level for control)	0CH	Double-word
CE (default setting level 2 for control)	0DH	Double-word
CF (warning setting level)	0EH	Double-word
D0 (display adjustment level)	0FH	Double-word
D1 (communication level)	10H	Double-word
D2 (high-performance setting level)	11H	Double-word
D3 (extended control setting level)	12H	Double-word

Indirect Memory Designation

	15	8 7	0
n + 0	Model (91 to 98)		Memory type
n + 1	Address No.		
n + 2	Expansion code		Bit designation
n + 3	00		Station number

For bit designation, an expansion code setting is required.
 00H: when designating bit 0 to 15
 01H: when designating bit 16 to 31

PLC_CTL

Macro command "PLC_CTL F0 F1 F2"

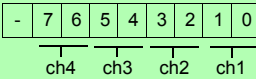
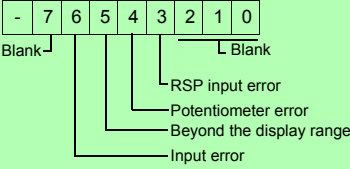
Contents	F0	F1 (= \$u n)	F2									
Read controller status	1 - 8 (PLC1 - 8)	n	Station number									
		n + 1	Command: 0006H									
		n + 2	Status  <table border="1" style="margin-top: 10px;"> <thead> <tr> <th>Bit</th> <th>Operation status</th> </tr> </thead> <tbody> <tr> <td>00</td> <td>Control in progress</td> </tr> <tr> <td>01</td> <td>Error occurring (outputting manipulated variables at an occurrence of error)</td> </tr> <tr> <td>10</td> <td>Resetting (including setting area 1)</td> </tr> <tr> <td>11</td> <td>Manual mode</td> </tr> </tbody> </table>	Bit	Operation status	00	Control in progress	01	Error occurring (outputting manipulated variables at an occurrence of error)	10	Resetting (including setting area 1)	11
Bit	Operation status											
00	Control in progress											
01	Error occurring (outputting manipulated variables at an occurrence of error)											
10	Resetting (including setting area 1)											
11	Manual mode											
n + 3	Relevant information 											
Operation instructions	1 - 8 (PLC1 - 8)	n	Station number *1									
		n + 1	Command: 0030H									
		n + 2	Communication writing 0000H: Communication writing OFF (disabled) 0001H: Communication writing ON (enabled) Control start/stop 0100H: Channel 1 RUN 0101H: Channel 1 STOP 0110H: Channel 2 RUN 0111H: Channel 2 STOP 0120H: Channel 3 RUN 0121H: Channel 3 STOP 0130H: Channel 4 RUN 0131H: Channel 4 STOP 01F0H: All channels Run 01F1H: All channels Stop Bank selection 0200 to 0207H: Channel 1 Bank Nos. 0 to 7 0210 to 0217H: Channel 2 Bank Nos. 0 to 7 0220 to 0227H: Channel 3 Bank Nos. 0 to 7 0230 to 0237H: Channel 4 Bank Nos. 0 to 7 02F0 to 02F7H: All channels Bank Nos. 0 to 7 AT execution 0300H: Channel 1 PID group number currently selected 0301 to 0308H: Channel 1 PID group Nos. 1 to 8 designation 0310H: Channel 2 PID group number currently selected 0311 to 0318H: Channel 2 PID group Nos. 1 to 8 designation 0320H: Channel 3 PID group number currently selected 0321 to 0328H: Channel 3 PID group Nos. 1 to 8 designation 0330H: Channel 4 PID group number currently selected 0331 to 0338H: Channel 4 PID group Nos. 1 to 8 designation 03F0H: All channels PID group number currently selected 03F1 to 03F8H: All channels PID group Nos. 1 to 8 designation	3								

Contents	F0	F1 (= \$u n)	F2	
Operation instructions	1 - 8 (PLC1 - 8)	n + 2	AT cancellation 0A00H: Channel 1 0A10H: Channel 2 0A20H: Channel 3 0A30H: Channel 4 09F0H: All channels	3
			Write mode 0400H: Backup mode 0401H: RAM write mode	
			0500H: Save RAM data	
			0600H: Software reset	
			0700H: Move to set area 1	
			0800H: Move to protect level	
			Auto/manual 0900H: Channel 1 Auto mode 0901H: Channel 1 Manual mode 0910H: Channel 2 Auto mode 0911H: Channel 2 Manual mode 0920H: Channel 3 Auto mode 0921H: Channel 3 Manual mode 0930H: Channel 4 Auto mode 0931H: Channel 4 Manual mode 09F0H: All channels Auto mode 09F1H: All channels Manual mode	
			0B00H: Initialize	
			Unlatch 0C00H: Channel 1 Warning unlatch 0C10H: Channel 2 Warning unlatch 0C20H: Channel 3 Warning unlatch 0C30H: Channel 4 Warning unlatch 0CF0H: All channels Warning unlatch	
			SP mode 0D00H: Channel 1 Local SP 0D01H: Channel 1 Remote SP 0D10H: Channel 2 Local SP (Cascade open) 0D11H: Channel 2 Remote SP (Cascade close)	

*1 8000 (HEX): broadcasting

Return data: Data stored from temperature controller to TS series

30.2.5 E5CK

Communication Setting

Editor

Communication setting

(Underlined setting: default)

Item	Setting	Remarks
Connection Mode	1 : 1 / <u>1:n</u> / Multi-link2 / Multi-link2 (Ethernet)	
Signal Level	RS-232C / <u>RS-422/485</u>	
Baud Rate	4800 / <u>9600</u> / 19200 bps	
Data Length	<u>7</u> / 8 bits	
Stop Bit	1 / <u>2</u> bits	
Parity	None / Odd / <u>Even</u>	
Target Port No.	<u>0</u> to 31	

Temperature Controller

(Underlined setting: default)

Mode	Displayed Character	Setting Data	Setting
Option mode	Sbit	Stop bit	1 / <u>2</u> bits
	LEn	Data length	<u>7</u> / 8 bits
	PrtY	Parity	None / Odd / <u>Even</u>
	bPS	Baud rate	4800 / <u>9600</u> / 19200 bps
	U-no	Communication unit No.	<u>0</u> to 31

Available Memory

The available memory setting range varies depending on the PLC model. Be sure to set within the range available for the PLC. Use [TYPE] when assigning the indirect memory for macro programs.

Memory	TYPE	Remarks
D (parameter)	00H	
S (special command)	01H	Write only, expansion code: fixed to 0

30.2.6 E5CK-T

Communication Setting

Editor

Communication setting

(Underlined setting: default)

Item	Setting	Remarks
Connection Mode	1 : 1 / <u>1:n</u> / Multi-link2 / Multi-link2 (Ethernet) / 1 : n Multi-link2 (Ethernet)	
Signal Level	RS-232C / <u>RS-422/485</u>	
Baud Rate	4800 / <u>9600</u> / 19200 bps	
Data Length	<u>7</u> / 8 bits	
Stop Bit	1 / <u>2</u> bits	
Parity	None / Odd / <u>Even</u>	
Station number	<u>0</u> to 99	

Temperature Controller

(Underlined setting: default)

Mode	Displayed Character	Setting Data	Setting
Option mode	Sbit	Stop bit	1 / <u>2</u> bits
	LEn	Data length	<u>7</u> / 8 bits
	PrtY	Parity	None / Odd / <u>Even</u>
	bPS	Baud Rate	4800 / <u>9600</u> / 19200 bps
	U-no	Communication unit No.	<u>0</u> to 99

Available Memory

The available memory setting range varies depending on the PLC model. Be sure to set within the range available for the PLC. Use [TYPE] when assigning the indirect memory for macro programs.

Memory	TYPE	Remarks
D (parameter)	00H	
S (special command)	01H	S00 to 11 Write only, expansion code: fixed to 0
		S14 Read only, expansion code 0: group A / 1: group B
P (program parameter)	02H	

Indirect Memory Designation

	15	8 7	0
n+0	Model (91 to 98)	Memory type	
n+1	Address No.		
n+2	Expansion code	Bit designation	
n+3	00	Station number	

When monitoring special command S14 (status), specify the group number in the expansion code.

00H: Group A

01H: Group B

30.2.7 E5CN-HT

Communication Setting

Editor

Communication setting

(Underlined setting: default)

Item	Setting	Remarks
Connection Mode	1 : 1 / <u>1:n</u> / Multi-link2 / Multi-link2 (Ethernet) 1 : n Multi-link2 (Ethernet)	
Signal Level	RS-232C / <u>RS-422/485</u>	
Baud Rate	4800 / <u>9600</u> / 19200 / 38400 / 57600 bps	
Data Length	<u>7</u> / 8 bits	
Stop Bit	1 / <u>2</u> bits	
Parity	None / Odd / <u>Even</u>	
Target Port No.	0 to 31	

Temperature Controller

E5CN-HT/E5AN-HT/E5EN-HT

Communication level setting

(Underlined setting: default)

Level	Displayed Character	Setting Data	Setting
Communication level	PSEL	Communication protocol	CompoWay/F
	U-no	Communication unit No.	0 to 31
	bps	Baud rate	4800 / <u>9600</u> / 19200 / 38400 / 57600 bps
	LEn	Data length	<u>7</u> / 8 bits
	Sbit	Stop bit	1 / <u>2</u> bits
	PrtY	Parity	None / Odd / <u>Even</u>
Adjustment level	CMWT	Communication writing ^{*1}	OFF / ON

*1 When writing the setting data from the TS, set "ON" for the "communication writing" setting.

Available Memory

The available memory setting range varies depending on the PLC model. Be sure to set within the range available for the PLC. Use [TYPE] when assigning the indirect memory for macro programs.

Memory	TYPE	Remarks
C0 (setting area 0)	00H	Double-word, read only
C1 (setting area 0)	01H	Double-word
C3 (setting area 1)	02H	Double-word
C4 (setting area 0)	03H	Double-word
C5 (setting area 0)	04H	Double-word
DA (setting area 0)	05H	Double-word

Indirect Memory Designation

	15	8 7	0
n + 0	Model (91 to 98)	Memory type	
n + 1	Address No.		
n + 2	Expansion code	Bit designation	
n + 3	00	Station number	

For bit designation, an expansion code setting is required.

00H: when designating bit 0 to 15

01H: when designating bit 16 to 31

PLC_CTL

Macro command "PLC_CTL F0 F1 F2"

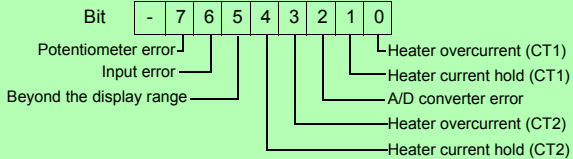
Contents	F0	F1 (= \$u n)		F2
Read controller status	1 - 8 (PLC1 - 8)	n	Station number	2
		n + 1	Command: 0006H	
		n + 2	<p>Operation status (higher byte) 00: Control not in execution (Setting area 1, outputting manipulated variables for manual operation, resetting operation or alarm occurrence) 01: Control in execution (Other than above)</p> <p>Related information (lower byte)</p> 	
Operation instructions	1 - 8 (PLC1 - 8)	n	Station number *1	3
		n + 1	Command: 0030H	
		n + 2	Communication writing 0000H: Communication writing OFF (disabled) 0001H: Communication writing ON (enabled)	
			Control start/stop 0100H: Channel 1 RUN 0101H: Channel 1 STOP	
			AT execution/cancel 0300H: AT cancel 0301H: AT execution at 100% 0302H: AT execution at 40%	
			Write mode 0400H: Backup mode 0401H: RAM write mode	
			0500H: Save RAM data	
			0600H: Software reset	
			0700H: Shift to set area 1	
			0800H: Protection level shift	
			Auto/manual 0900H: Auto mode 0901H: Manual mode	
			0B00H: Initialize	
			Alarm latch cancel 0C00H: Alarm latch 1 cancel 0C01H: Alarm latch 2 cancel 0C02H: Alarm latch 3 cancel 0C03H: Heater disconnection latch cancel 0C04H: SSR failure latch cancel 0C05H: Heater overcurrent latch cancel 0C0FH: All latch cancel	
			SP mode 0D00H: Program SP mode 0D01H: Remote SP mode 0D02H: Constant value control SP mode	
			Invert direct/reverse operation 0E00H: Not invert 0E01H: Invert	
			Infrared communication 1200H: OFF 1201H: ON	
Hold 1300H: Hold cancel 1301H: Hold				
1400H: Advance				
Readout of main unit's attribute	1 - 8 (PLC1 - 8)	n	Station number	2
		n + 1	Command: 0005H	
		n + 2 - n + 6	Type (CHAR) * Data following 11th byte or later is discarded.	
		n + 8	Buffer size (HEX)	

*1 8000 (HEX): broadcasting

Response code: Data stored from temperature controller to TS series

30.2.8 E5EK

Communication Setting

Editor

Communication setting

(Underlined setting: default)

Item	Setting	Remarks
Connection Mode	1 : 1 / <u>1:n</u> / Multi-link2 / Multi-link2 (Ethernet)	
Signal Level	RS-232C / <u>RS-422/485</u>	
Baud Rate	4800 / <u>9600</u> / 19200 bps	
Data Length	<u>7</u> / 8 bits	
Stop Bit	1 / <u>2</u> bits	
Parity	None / Odd / <u>Even</u>	
Target Port No.	<u>0</u> to 31	

Temperature Controller

(Underlined setting: default)

Mode	Displayed Character	Setting Data	Setting
Option mode	Sbit	Stop bit	1 / <u>2</u> bits
	LEn	Data length	<u>7</u> / 8 bits
	PrtY	Parity	None / Odd / <u>Even</u>
	bPS	Baud rate	4800 / <u>9600</u> / 19200 bps
	U-no	Communication unit No.	<u>0</u> to 31

Available Memory

The available memory setting range varies depending on the PLC model. Be sure to set within the range available for the PLC. Use [TYPE] when assigning indirect memory for macro programs.

Memory	TYPE	Remarks
D (parameter)	00H	
S (special command)	01H	S00 to 11 Write only, expansion code: fixed to 0
		S14 Read only, expansion code 0: group A / 1: group B

Indirect Memory Designation

	15	8 7	0
n+0	Model (91 to 98)	Memory type	
n+1	Address No.		
n+2	Expansion code	Bit designation	
n+3	00	Station number	

When monitoring special command S14 (status), specify the group number in the expansion code.

00H: Group A

01H: Group B

30.2.9 E5ZD

Communication Setting

Editor

Communication setting

(Underlined setting: default)

Item	Setting	Remarks
Connection Mode	1 : 1 / <u>1:n</u> / Multi-link2 / Multi-link2 (Ethernet)	
Signal Level	RS-232C / <u>RS-422/485</u>	
Baud Rate	4800 / <u>9600</u> bps	
Data Length	<u>7</u> bits	
Stop Bit	<u>2</u> bits	
Parity	<u>Even</u>	
Target Port No.	<u>0</u> to 15	

Temperature Controller

(Underlined setting: default)

Switch	Setting Data	Setting
SW2	Unit No.	<u>0</u> to F (= 0 to 15)
SW3	Baud rate	5: 4800 bps 6: 9600 bps

The following settings are fixed; data length: 7, stop bit: 2, and parity: even.

Available Memory

The available memory setting range varies depending on the PLC model. Be sure to set within the range available for the PLC. Use [TYPE] when assigning the indirect memory for macro programs.

Memory	TYPE	Remarks
0000 Control temperature	00H	
0001 Measurement temperature		Bank No. 0
0002 Operation status		Bank No. 0
0003 Output value		Bank No. 0
0004 Output value on the cooling side		Bank No. 0
0005 Proportional band		
0006 Integral time		
0007 Derivative time		
0008 Control cycle		
0009 Control cycle on the cooling side		
000A Output operation		Bank No. 0
000B Heater disconnection effective channel		Bank No. 0
000C Alarm status		Bank No. 0
000D Warning mode: warning 1		Bank No. 0
000E Warning mode: warning 2		Bank No. 0
000F Temperature at which an alarm occurs: warning 1		
0010 Temperature at which an alarm occurs: warning 2		
0011 Execution memory bank No.		Bank No. 0
0012 Adjustment sensitivity		
0013 Adjustment sensitivity on the cooling side		
0015 Input offset value		
001D Heater disconnection detection level		
001F Heater current value	Bank No. 0	
0021 Deadband / overlap band	Bank No. 0	
0022 Cooling coefficient		

Memory		TYPE	Remarks
-	0023 Fuzzy strength	00H	
	0024 Fuzzy scale 1		
	0025 Fuzzy scale 2		

Address denotations: Example: xx.yyyyzz

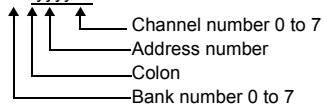

Indirect Memory Designation

	15	8 7	0
n+0	Model (91 to 98)	Memory type	
n+1	Address No. (lower)	CH No.	
n+2	00	Address No. (higher)	
n+3	Bank No.	Bit designation	
n+4	00	Station number	

PLC_CTL

Macro command "PLC_CTL F0 F1 F2"

Contents	F0	F1 (= \$u n)		F2
		n		
Auto tuning	1 to 8 (PLC1 to 8)	n	Station number	3
		n+1	Command: 0	
		n+2	0 to 7: AT start channel number 12: Cancel	
Setting data	1 to 8 (PLC1 to 8)	n	Station number	3
		n+1	Command: 3	
		n+2	0: Save 1: Initialize	
Operation control	1 to 8 (PLC1 to 8)	n	Station number	4
		n+1	Command: 4	
		n+2	0: Control start 1: Control stop	
		n+3	Channel number	

 Return data: Data stored from temperature controller to TS series

30.2.10 E5ZE

Communication Setting

Editor

Communication setting

(Underlined setting: default)

Item	Setting	Remarks
Connection Mode	1 : 1 / <u>1:n</u> / Multi-link2 / Multi-link2 (Ethernet)	
Signal Level	RS-232C / <u>RS-422/485</u>	
Baud Rate	4800 / <u>9600</u> / 19200 bps	
Data Length	7 bits	
Stop Bit	2 bits	
Parity	Even	
Target Port No.	<u>0</u> to 15	

Temperature Controller

Unit No.

(Underlined setting: default)

UNIT	Setting Items	Setting
	Unit No.	<u>0</u> to F (= 0 to 15)

Function

(Underlined setting: default)

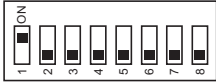
FUNCTION	Setting Items	Setting												
 SW1 SW2	Baud rate	<table border="1"> <thead> <tr> <th></th> <th>4800</th> <th><u>9600</u></th> <th>19200</th> </tr> </thead> <tbody> <tr> <td>SW1</td> <td>OFF</td> <td>ON</td> <td>OFF</td> </tr> <tr> <td>SW2</td> <td>ON</td> <td>OFF</td> <td>OFF</td> </tr> </tbody> </table>		4800	<u>9600</u>	19200	SW1	OFF	ON	OFF	SW2	ON	OFF	OFF
	4800	<u>9600</u>	19200											
SW1	OFF	ON	OFF											
SW2	ON	OFF	OFF											

Specification setting (RS-422/485)

FUNCTION	Setting Items	Setting												
 SW1 SW2	Interface	<table border="1"> <thead> <tr> <th></th> <th>RS-422</th> <th>RS-485</th> </tr> </thead> <tbody> <tr> <td>SW1</td> <td>OFF</td> <td>ON</td> </tr> <tr> <td>SW2</td> <td>OFF</td> <td>ON</td> </tr> </tbody> </table>		RS-422	RS-485	SW1	OFF	ON	SW2	OFF	ON			
		RS-422	RS-485											
SW1	OFF	ON												
SW2	OFF	ON												
SW3 SW4	Terminating resistance	<table border="1"> <thead> <tr> <th></th> <th>Provided (RS-422)</th> <th>Provided (RS-485)</th> <th>None</th> </tr> </thead> <tbody> <tr> <td>SW3</td> <td>ON</td> <td>ON</td> <td>OFF</td> </tr> <tr> <td>SW4</td> <td>ON</td> <td>OFF</td> <td>OFF</td> </tr> </tbody> </table>		Provided (RS-422)	Provided (RS-485)	None	SW3	ON	ON	OFF	SW4	ON	OFF	OFF
	Provided (RS-422)	Provided (RS-485)	None											
SW3	ON	ON	OFF											
SW4	ON	OFF	OFF											

The following settings are fixed; data length: 7, stop bit: 2, and parity: even.

Available Memory

The available memory setting range varies depending on the PLC model. Be sure to set within the range available for the PLC. Use [TYPE] when assigning the indirect memory for macro programs.

Memory	TYPE	Remarks
0000 Control temperature	00H	
0001 Measurement temperature		Bank No. 0
0002 Operation status		Bank No. 0
0003 Output value		Bank No. 0
0004 Output value on the cooling side		Bank No. 0
0005 Proportional band		
0006 Integral time		
0007 Derivative time		
0008 Control cycle		
0009 Control cycle on the cooling side		
000A Output operation		Bank No. 0
000B HB warning/HS warning effective channel		Bank No. 0
000C Alarm status		Bank No. 0
000D Warning mode: warning 1		Bank No. 0
000E Warning mode: warning 2		Bank No. 0
000F Temperature at which an alarm occurs: warning 1		
0010 Temperature at which an alarm occurs: warning 2		
0011 Execution memory bank No.		Bank No. 0
0012 Adjustment sensitivity		
0013 Adjustment sensitivity on the cooling side		
0014 Setting unit		Bank No. 0
0015 Input offset value		
0016 Manual reset value		
0017 Current control temperature		
0018 Output lower limit value		Bank No. 0
0019 Output upper limit value		
001A Output lower limit value on the cooling side		
001B Output upper limit value on the cooling side		
001C Limit of output change rate		
001D Heater disconnection detection (HB warning)		
001E SSR failure detection (HS warning)	Bank No. 0	
001F Heater current value	Bank No. 0	
0020 SSR leakage current value	Bank No. 0	
0021 Deadband / overlap band	Bank No. 0	
0022 Cooling coefficient		
0023 Fuzzy strength		
0024 Fuzzy scale 1		
0025 Fuzzy scale 2		

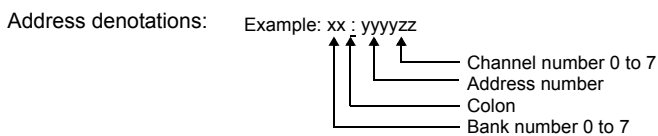

Indirect Memory Designation

	15	8 7	0
n + 0	Model (91 to 98)	Memory type	
n + 1	Address No. (lower)	CH No.	
n + 2	00	Address No. (higher)	
n + 3	Bank No.	Bit designation	
n + 4	00	Station number	

PLC_CTL

Macro command "PLC_CTL F0 F1 F2"

Contents	F0	F1 (= \$u n)		F2
Auto tuning	1 - 8 (PLC1 - 8)	n	Station number	3
		n + 1	Command: 0	
		n + 2	0 - 7: AT start channel No. 10: Collective start at all channels 11: Sequential start at all channels 12: Cancel	
Lamp value setting	1 - 8 (PLC1 - 8)	n	Station number	5
		n + 1	Command: 1	
		n + 2	Bank No. / channel No.	
		n + 3	Lamp value	
		n + 4	Unit of time 0: Second 1: Minute 2: Hour	
Lamp value read out	1 - 8 (PLC1 - 8)	n	Station number	3
		n + 1	Command: 2	
		n + 2	Bank No. / channel No.	
		n + 3	Lamp value	
		n + 4	Unit of time 0: Second 1: Minute 2: Hour	
Setting data	1 - 8 (PLC1 - 8)	n	Station number	3
		n + 1	Command: 3	
		n + 2	0: Save 1: Initialize	
Operation control	1 - 8 (PLC1 - 8)	n	Station number	4
		n + 1	Command: 4	
		n + 2	0: Control start 1: Control stop	
		n + 3	Channel No.	
Manual operation	1 - 8 (PLC1 - 8)	n	Station number	3
		n + 1	Command: 5	
		n + 2	Channel No.	

Return data: Data stored from temperature controller to TS series

30.2.11 E5ZN

Communication Setting

Editor



Communication setting

(Underlined setting: default)

Item	Setting	Remarks
Connection Mode	1 : 1 / <u>1:n</u> / Multi-link2 / Multi-link2 (Ethernet)	
Signal Level	RS-232C / <u>RS-422/485</u>	
Baud Rate	4800 / <u>9600</u> / 19200 bps	
Data Length	<u>7</u> / 8 bits	
Stop Bit	1 / <u>2</u> bits	
Parity	None / Odd / <u>Even</u>	
Target Port No.	<u>0</u> to 15	

Temperature Controller

(Underlined setting: default)

Item	Setting Data	Setting
UNIT		Unit No. 0 to F (= 0 to 15)
BPS		Baud rate 0: 4800 <u>1: 9600</u> 2: 19200 3: 38400
Communication level	LEn	Data length <u>7</u> / 8 bits
	Sbit	Stop bit 1 / <u>2</u> bits
	Prty	Parity None / <u>Even</u> / Odd
Adjustment level	CMWT	Communication writing *1 OFF / ON

*1 When writing the setting data from the TS, set "ON" for the "communication writing" setting.

Available Memory

The available memory setting range varies depending on the PLC model. Be sure to set within the range available for the PLC. Use [TYPE] when assigning the indirect memory for macro programs.

Memory	TYPE	Remarks
C0 Setting area 0	00H	Double-word, read only
C1 Setting area 0	01H	Double-word
C3 Setting area 1	02H	Double-word

Indirect Memory Designation

	15	8 7	0
n + 0	Model (91 to 98)	Memory type	
n + 1	Address No.		
n + 2	Expansion code	Bit designation	
n + 3	00	Station number	

For bit designation, an expansion code setting is required.

- 00H: when designating bit 0 to 15
- 01H: when designating bit 16 to 31

PLC_CTL

Macro command "PLC_CTL F0 F1 F2"

Contents	F0	F1 (= \$u n)		F2						
Controller status read out	1 - 8 (PLC1 - 8)	n	Station number	2						
		n + 1	Command: 06H							
		n + 2	<p>Operation status (higher byte)</p> <p>00: Control in execution for all channels (Operation in progress while the setting area is "0" with no error occurring.)</p> <p>01: Control stopping at any of the channels (Other than above)</p> <p>Related information (lower byte)</p> <p>Bit <table border="1" style="display: inline-table; vertical-align: middle;"> <tr> <td>-</td><td>7</td><td>6</td><td>5</td><td>4</td><td>3</td><td>2</td><td>1</td><td>0</td> </tr> </table></p> <p style="margin-left: 40px;">Blank Input error Blank Overcurrent Current hold</p>		-	7	6	5	4	3
-	7	6	5	4	3	2	1	0		
Operation instructions	1 - 8 (PLC1 - 8)	n	Station number *1	3						
		n + 1	Command: 0030H							
		n + 2	Communication writing 0000H: Communication writing OFF (disabled) 0001H: Communication writing ON (enabled)							
			Control start/stop 0100H: Channel 1 run 0101H: Channel 1 stop 0110H: Channel 2 run 0111H: Channel 2 stop 01F0H: All-channel run *2 01F1H: All-channel stop *2							
			Multi-SP 0200H: Channel 1 target value 0 0201H: Channel 1 target value 1 0210H: Channel 2 target value 0 0211H: Channel 2 target value 1 02F0H: All-channel target value 0 *2 02F1H: All-channel target value 1 *2							
			AT execution 0300H: Channel 1 AT execute 0301H: Channel 1 AT cancel 0310H: Channel 2 AT execute 0311H: Channel 2 AT cancel 03F0H: All-channel AT execute *2 03F1H: All-channel AT cancel *2							
			Write mode 0400H: Backup mode 0401H: RAM write mode							
			0500H: Save RAM data							
			0600H: Software reset							
			0700H: Move to set area 1							
			0800H: Move to protection level							
			Auto/manual 0900H: PV hold							
			0B00H: Initialize							
Unlatch 0C00H: Channel 1 warning 1 unlatch *2 0C01H: Channel 1 warning 2 unlatch *2 0C031H: Channel 1 warning 3 unlatch *2 0C0FH: Channel 1 all warnings unlatch *2 0C10H: Channel 2 warning 1 unlatch *2 0C11H: Channel 2 warning 2 unlatch *2 0C13H: Channel 2 warning 3 unlatch *2 0C1FH: Channel 2 all warnings unlatch *2 0CF0H: All channels warning 1 unlatch *2 0CF1H: All channels warning 2 unlatch *2 0CF2H: All channels warning 3 unlatch *2 0CFFH: All channels all warnings unlatch *2										

Return data: Data stored from temperature controller to TS series

*1 8000 (HEX): broadcasting

*2 Valid only for the product of pulse output type or analog output type

30.2.12 V600/620/680

Communication Setting

Editor

Communication setting

(Underlined setting: default)

Item	Setting	Remarks
Connection Mode	1 : 1 / <u>1 : n</u> / Multi-link2	
Signal Level	<u>RS-232C</u> / RS-422/485	
Baud Rate	4800 / 9600 / <u>19200</u> / 38400 / 115K bps	
Data Length	<u>7</u> / 8 bits	
Stop Bit	1 / <u>2</u> bits	
Parity	None / Odd / <u>Even</u>	
Target Port No.	<u>0</u> to 31	
Transmission Mode	1 : 1 procedure / <u>1 : N procedure</u>	The transmission mode is set according to the connection mode. 1 : 1 → 1 : 1 procedure 1 : n → 1 : N procedure Multi-link2 → 1 : 1 procedure / 1 : N procedure

Device memory map setting

Reading or writing to/from the tag can be performed by using the [Synchronized Reading/Synchronized Writing] function of the device memory map.

- Synchronized reading

Reading starts when the control memory (command bit) is set (ON). Reading is performed at specified cycles until the control memory (acknowledge bit) is set (ON).

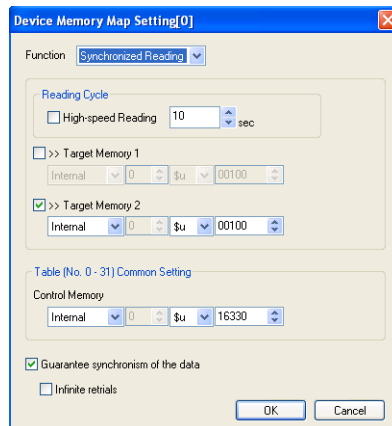

Reading Cycle	The data at the memory addresses registered in the device memory map is read when the control memory (command bit) is set (ON). Reading of data is repeated at specified cycles until the data is read correctly. When the data has correctly been read, the control memory (acknowledge bit) is set (ON) and reading operation finishes. *1
Control Memory	Enter a memory address as the trigger for synchronized reading. The specified memory address is used for the device memory map Nos. 0 to 31. Four words are occupied. For more information, see "Control Memory" (page App1-11).
<input type="checkbox"/> Guarantee synchronism of the data	When the box is checked, retry is made until the first data in the device memory map is read correctly. *2 *3 Check the status/error codes at \$Pn 356 to 451 to confirm whether or not reading of subsequent data has been completed successfully.
<input type="checkbox"/> Infinite retrials	When the box is checked, retry is made until all data in the device memory map is read correctly. *3 Status/error codes are stored in \$Pn 356 to 451.

*1 When both [Guarantee synchronism of the data] and [Infinite retrials] are not checked, the acknowledge bit is set (ON) when reading of any data at the memory address registered in the device memory map has been completed successfully.

*2 Set the memory address of the same station number and channel in the device memory map.

*3 This setting is invalid when the macro command "TBL_READ" is executed.

- Synchronized writing
Writing starts when the control memory (command bit) is set (ON). When writing has been finished, the control memory (acknowledge bit) is set (ON).

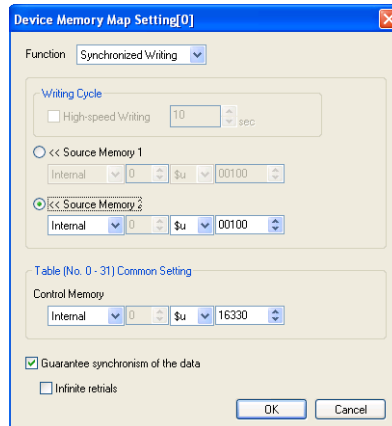

Writing Cycle	The data is written into the memory addresses registered in the device memory map when the control memory (command bit) is set (ON). When writing of data finishes, the control memory (acknowledge bit) is set (ON) regardless of the result of the writing status.
Control Memory	Enter a memory address as the trigger for synchronized writing. The specified memory address is used for the device memory map Nos. 0 to 31. Four words are occupied. For more information, see "Control Memory" (page App1-11).
<input type="checkbox"/> Guarantee synchronism of the data	When the box is checked, retry is made until the first data is correctly written into the address registered in the device memory map. *1 Check the status/error codes at \$Pn 356 to 451 to confirm whether or not writing of subsequent data has been completed successfully.
<input type="checkbox"/> Infinite retrials	When the box is checked, retry is made until all data is correctly written into the addresses registered in the device memory map. *1 Status/error codes are stored in \$Pn 356 to 451.

*1 Set the memory address of the same station number and channel in the device memory map.

*2 This setting is invalid when the macro command "TBL_WRITE" is executed.

ID Controller

V600-CA1A/V600-CA2A



(Default: OFF (all))

DIP Switch		Setting																																								
DIP switch 1 	SW1 SW2 SW3	Baud rate setting <table border="1"> <thead> <tr> <th>SW1</th> <th>SW2</th> <th>SW3</th> <th>Baud Rate</th> </tr> </thead> <tbody> <tr> <td>ON</td> <td>OFF</td> <td>ON</td> <td>4800</td> </tr> <tr> <td>ON</td> <td>ON</td> <td>OFF</td> <td>9600</td> </tr> <tr> <td>ON</td> <td>ON</td> <td>ON</td> <td>19200</td> </tr> </tbody> </table>	SW1	SW2	SW3	Baud Rate	ON	OFF	ON	4800	ON	ON	OFF	9600	ON	ON	ON	19200																								
	SW1	SW2	SW3	Baud Rate																																						
	ON	OFF	ON	4800																																						
ON	ON	OFF	9600																																							
ON	ON	ON	19200																																							
SW4 SW5 SW6	Communication format <table border="1"> <thead> <tr> <th>SW4</th> <th>SW5</th> <th>SW6</th> <th>Data Length</th> <th>Stop Bit</th> <th>Parity</th> </tr> </thead> <tbody> <tr> <td>OFF</td> <td>OFF</td> <td>OFF</td> <td rowspan="3">7</td> <td rowspan="2">2</td> <td>Even</td> </tr> <tr> <td>OFF</td> <td>OFF</td> <td>ON</td> <td>Odd</td> </tr> <tr> <td>OFF</td> <td>ON</td> <td>OFF</td> <td rowspan="3">8</td> <td rowspan="2">1</td> <td>Even</td> </tr> <tr> <td>OFF</td> <td>ON</td> <td>ON</td> <td>Odd</td> </tr> <tr> <td>ON</td> <td>OFF</td> <td>OFF</td> <td rowspan="3">8</td> <td rowspan="3">2</td> <td>None</td> </tr> <tr> <td>ON</td> <td>OFF</td> <td>ON</td> <td rowspan="2">1</td> <td>Even</td> </tr> <tr> <td>ON</td> <td>ON</td> <td>OFF</td> <td>Odd</td> </tr> </tbody> </table>	SW4	SW5	SW6	Data Length	Stop Bit	Parity	OFF	OFF	OFF	7	2	Even	OFF	OFF	ON	Odd	OFF	ON	OFF	8	1	Even	OFF	ON	ON	Odd	ON	OFF	OFF	8	2	None	ON	OFF	ON	1	Even	ON	ON	OFF	Odd
SW4	SW5	SW6	Data Length	Stop Bit	Parity																																					
OFF	OFF	OFF	7	2	Even																																					
OFF	OFF	ON			Odd																																					
OFF	ON	OFF		8	1	Even																																				
OFF	ON	ON	Odd																																							
ON	OFF	OFF	8		2	None																																				
ON	OFF	ON		1		Even																																				
ON	ON	OFF				Odd																																				
SW7 SW8	Always OFF																																									

DIP Switch		Setting									
<p>DIP switch 2</p> 	SW2 SW3 SW4 SW5	Unit No. (Valid only when "1 : N" is selected by SW6. When "1 : 1" is selected, set all switches to the OFF positions.)									
		SW2	SW3	SW4	SW5	No.	SW2	SW3	SW4	SW5	No.
		OFF	OFF	OFF	OFF	0	ON	OFF	OFF	OFF	8
		OFF	OFF	OFF	ON	1	ON	OFF	OFF	ON	9
	OFF	OFF	ON	OFF	2	ON	OFF	ON	OFF	10	
	OFF	OFF	ON	ON	3	ON	OFF	ON	ON	11	
	OFF	ON	OFF	OFF	4	ON	ON	OFF	OFF	12	
	OFF	ON	OFF	ON	5	ON	ON	OFF	ON	13	
	OFF	ON	ON	OFF	6	ON	ON	ON	OFF	14	
	OFF	ON	ON	ON	7	ON	ON	ON	ON	15	
	SW6	Communication protocol OFF: 1 : 1 ON: 1 : N									
	SW7	Terminating resistance at sending side (valid only for RS-422) OFF: Not provided ON: Provided									
	SW8	Terminating resistance at receiving side (valid only for RS-422) OFF: Not provided ON: Provided									

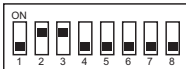

V600-CD1D

(Default: OFF (all))

DIP Switch		Setting									
<p>DIP switch 1</p> 	SW2 SW3	Baud rate setting									
		SW2	SW3	Baud Rate							
		OFF	ON	4800							
	ON	OFF	9600								
	ON	ON	19200								
	SW4 SW5 SW6	Communication format									
		SW4	SW5	SW6	Data Length	Stop Bit	Parity				
		OFF	OFF	OFF	7	2	Even				
		OFF	OFF	ON			Odd				
		OFF	ON	OFF		8	1	Even			
		OFF	ON	ON	Odd						
		ON	OFF	OFF	8		2	None			
		ON	OFF	ON		1		Even			
		ON	ON	OFF				Odd			
	SW8	Always OFF									
<p>DIP switch 2</p> 	SW3 SW4 SW5	Unit No. (Valid only when "1 : N" is selected by SW6. When "1 : 1" is selected, set all switches to the OFF positions.)									
		SW3	SW4	SW5	Unit No.						
		OFF	OFF	OFF	0						
		OFF	OFF	ON	1						
		OFF	ON	OFF	2						
		OFF	ON	ON	3						
		ON	OFF	OFF	4						
		ON	OFF	ON	5						
		ON	ON	OFF	6						
		ON	ON	ON	7						
	SW6	Communication protocol OFF: 1 : 1 ON: 1 : N									
	SW7 SW8	Always OFF									

V680

(Default: OFF (all))

Switch Setting		Setting															
SW1 SW2	Controller No. setting	0 to 31 (32 to 99: not available)  Higher-order digit: 0 to 3  Lower-order digit: 0 to 9															
SW3-1	Switch selection	OFF: DIP switch enabled															
SW3-3 SW3-4	Baud rate setting	<table border="1"> <thead> <tr> <th>SW3-3</th> <th>SW3-4</th> <th>Baud Rate</th> </tr> </thead> <tbody> <tr> <td>OFF</td> <td>OFF</td> <td>9600</td> </tr> <tr> <td>OFF</td> <td>ON</td> <td>19200</td> </tr> <tr> <td>ON</td> <td>OFF</td> <td>38400</td> </tr> <tr> <td>ON</td> <td>ON</td> <td>115200</td> </tr> </tbody> </table>	SW3-3	SW3-4	Baud Rate	OFF	OFF	9600	OFF	ON	19200	ON	OFF	38400	ON	ON	115200
SW3-3	SW3-4	Baud Rate															
OFF	OFF	9600															
OFF	ON	19200															
ON	OFF	38400															
ON	ON	115200															
SW3-5	Data length setting	OFF: 7 bits ON: 8 bits															
SW3-6 SW3-7	Parity	<table border="1"> <thead> <tr> <th>SW3-6</th> <th>SW3-7</th> <th>Parity</th> </tr> </thead> <tbody> <tr> <td>OFF</td> <td>OFF</td> <td>Even</td> </tr> <tr> <td>OFF</td> <td>ON</td> <td>None</td> </tr> <tr> <td>ON</td> <td>OFF</td> <td>Odd</td> </tr> <tr> <td>ON</td> <td>ON</td> <td>Even</td> </tr> </tbody> </table>	SW3-6	SW3-7	Parity	OFF	OFF	Even	OFF	ON	None	ON	OFF	Odd	ON	ON	Even
SW3-6	SW3-7	Parity															
OFF	OFF	Even															
OFF	ON	None															
ON	OFF	Odd															
ON	ON	Even															
SW3-8	Stop bit	OFF: 2 bits ON: 1 bit															
SW3-9	Communication protocol	OFF: 1 : 1 ON: 1 : N															
SW3-10	Command system	ON: V600 command format															

Available Memory

The available memory setting range varies depending on the PLC model. Be sure to set within the range available for the PLC. Use [TYPE] when assigning the indirect memory for macro programs.

Memory	TYPE	Remarks
-- Setting area 0	00H	

Indirect Memory Designation

	15	8 7	0
n + 0	Model (91 to 98)	Memory type	
n + 1	Address No.		
n + 2	Channel No.	Bit designation	
n + 3	00	Station number	

PLC_CTL

Macro command "PLC_CTL F0 F1 F2"

Contents	F0	F1 (= \$u n)		F2
Read (specified with ASCII code) Channel 1	1 - 8 (PLC1 - 8)	n	Station number	4
		n + 1	Command: 0	
		n + 2	Top address	
		n + 3	Word count: m	
		n + 4 to n + (3 + m)	Read data	
Write (specified with ASCII code) Channel 1	1 - 8 (PLC1 - 8)	n	Station number	4 + m
		n + 1	Command: 1	
		n + 2	Top address	
		n + 3	Word count: m	
		n + 4 to n + (3 + m)	Write data	
Command process abort	1 - 8 (PLC1 - 8)	n	Station number	2
		n + 1	Command: 2	
Data management Channel 1 Data check command: compare	1 - 8 (PLC1 - 8)	n	Station number	4
		n + 1	Command: 3	
		n + 2	Top address	
		n + 3	Bytes	
Data management Channel 1 Data check command: calculation	1 - 8 (PLC1 - 8)	n	Station number	4
		n + 1	Command: 4	
		n + 2	Top address	
		n + 3	Bytes	
Data management Channel 1 Writing count management command: subtraction	1 - 8 (PLC1 - 8)	n	Station number	4
		n + 1	Command: 5	
		n + 2	Top address	
		n + 3	Number of updates	
Data management Channel 1 Writing count management command: addition	1 - 8 (PLC1 - 8)	n	Station number	4
		n + 1	Command: 6	
		n + 2	Top address	
		n + 3	Number of updates	
Repeated writing	1 - 8 (PLC1 - 8)	n	Station number	2
		n + 1	Command: 7	
Controller control	1 - 8 (PLC1 - 8)	n	Station number	4
		n + 1	Command: 8	
		n + 2	OUT1 operation 0: No operation 1: ON 2: OFF	
		n + 3	OUT2 operation 0: No operation 1: ON 2: OFF	
		n + 4	Current input status (IN1) 0: OFF 1: ON	
		n + 5	Current input status (IN2) 0: OFF 1: ON	
		n + 6	Output status after execution of operation (OUT1) 0: OFF 1: ON	
		n + 7	Output status after execution of operation (OUT2) 0: OFF 1: ON	
Error information read out	1 - 8 (PLC1 - 8)	n	Station number	2
		n + 1	Command: 9	
		n + 2 to n + 4	Latest error log information (new)	
		n + 5 to n + 91	Latest error log information (old), max. 29 logs	
Abort (reset)	1 - 8 (PLC1 - 8)	n	Station number	2
		n + 1	Command: 10	
Exit code acquisition Channel 1	1 - 8 (PLC1 - 8)	n	Station number	2
		n + 1	Command: 12	
		n + 2	Exit code *1	

Contents	F0	F1 (= \$u n)		F2
Read (specified with ASCII code) Channel 2	1 - 8 (PLC1 - 8)	n	Station number	4
		n + 1	Command: 100	
		n + 2	Top address	
		n + 3	Word count: m	
		n + 4 to n + (3 + m)	Read data	
Write (specified with ASCII code) Channel 2	1 - 8 (PLC1 - 8)	n	Station number	4 + m
		n + 1	Command: 101	
		n + 2	Top address	
		n + 3	Word count: m	
		n + 4 to n + (3 + m)	Write data	
Data management Channel 2 Data check command: compare	1 - 8 (PLC1 - 8)	n	Station number	4
		n + 1	Command: 103	
		n + 2	Top address	
		n + 3	Bytes	
Data management Channel 2 Data check command: calculation	1 - 8 (PLC1 - 8)	n	Station number	4
		n + 1	Command: 104	
		n + 2	Top address	
		n + 3	Bytes	
Data management Channel 2 Writing count management command: subtraction	1 - 8 (PLC1 - 8)	n	Station number	4
		n + 1	Command: 105	
		n + 2	Top address	
		n + 3	Number of updates	
Data management Channel 2 Writing count management command: addition	1 - 8 (PLC1 - 8)	n	Station number	4
		n + 1	Command: 106	
		n + 2	Top address	
		n + 3	Number of updates	
Exit code acquisition Channel 2	1 - 8 (PLC1 - 8)	n	Station number	2
		n + 1	Command: 112	
		n + 2	Exit code *1	

 Return data: Data stored from temperature controller to TS series

*1 The exit code will not be stored if it cannot be acquired due to timeout or other reasons.

Operation

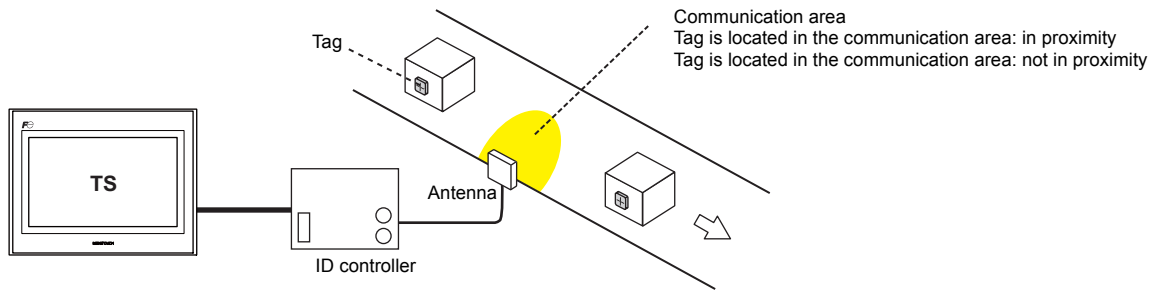

When a tag is located in proximity:

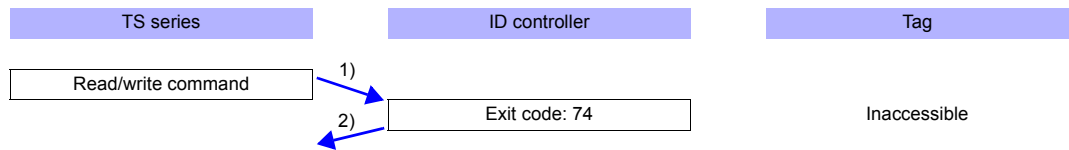

- 1) The TS series sends the read/write command.
- 2) Since the tag is not located in an accessible position, the TS series receives exit code 74 from the ID controller.
- 3) When [Synchronized Reading] is selected in the [Device Memory Map Setting] dialog and the control memory (command bit) is set (ON):
 - 1) is executed at cycles specified for [Reading Cycle].

When a tag is not located in proximity (reading/writing possible):

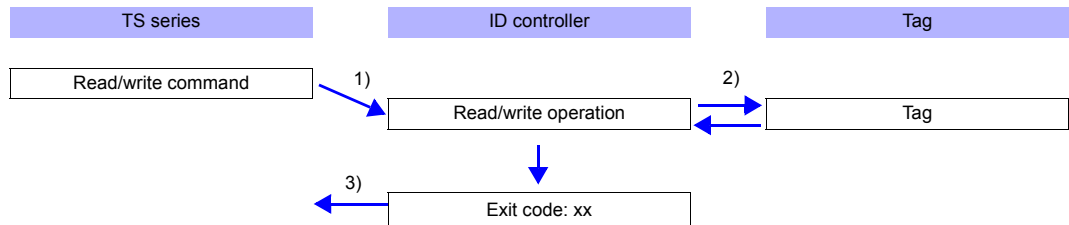

- 1) The TS series sends the read/write command.
- 2) The ID controller executes reading/writing from/into the tag.
- 3) The TS series receives the exit code from the ID controller.
 - Exit code (00, 74): Finish
 - Exit code (other than 00 or 74): Steps 1) to 3) are repeated the set number of retrial times.

System Memory

\$Pn 356 to 451

When [Guarantee synchronism of the data] is checked in the [Device Memory Map Setting] dialog, a status/error code of each memory map is stored here. For more information, see page App3-6.

30.2.13 KM20

Communication Setting

Editor

Communication setting

(Underlined setting: default)

Item	Setting	Remarks
Connection Mode	1 : 1 / <u>1:n</u> / Multi-link2 / Multi-link2 (Ethernet)	
Signal Level	RS-232C / <u>RS-422/485</u>	
Baud Rate	4800 / <u>9600</u> / 19200 / 38400 bps	
Data Length	<u>7</u> / 8 bits	
Stop Bit	1 / <u>2</u> bits	
Parity	None / Odd / <u>Even</u>	
Target Port No.	<u>0</u> to 99	

Temperature Controller

Communication setting switch

COMMUNICATION SETTING SW		Setting Data	Remarks																				
SW1 SW2 SW3	Baud rate	<table border="1"> <thead> <tr> <th>SW1</th> <th>SW2</th> <th>SW3</th> <th>Baud Rate</th> </tr> </thead> <tbody> <tr> <td>ON</td> <td>ON</td> <td>OFF</td> <td>4800</td> </tr> <tr> <td>OFF</td> <td>OFF</td> <td>OFF</td> <td>9600</td> </tr> <tr> <td>ON</td> <td>OFF</td> <td>ON</td> <td>19200</td> </tr> <tr> <td>OFF</td> <td>ON</td> <td>ON</td> <td>38400</td> </tr> </tbody> </table>	SW1	SW2	SW3	Baud Rate	ON	ON	OFF	4800	OFF	OFF	OFF	9600	ON	OFF	ON	19200	OFF	ON	ON	38400	
SW1	SW2	SW3	Baud Rate																				
ON	ON	OFF	4800																				
OFF	OFF	OFF	9600																				
ON	OFF	ON	19200																				
OFF	ON	ON	38400																				
SW4	Data bits	OFF: 7 bits ON: 8 bits																					
SW5	Stop bit	OFF: 2 bits ON: 1 bit																					
SW6 SW7	Parity	<table border="1"> <thead> <tr> <th>SW6</th> <th>SW7</th> <th>Parity</th> </tr> </thead> <tbody> <tr> <td>OFF</td> <td>OFF</td> <td>Even</td> </tr> <tr> <td>ON</td> <td>OFF</td> <td>Odd</td> </tr> <tr> <td>OFF</td> <td>ON</td> <td>None</td> </tr> </tbody> </table>	SW6	SW7	Parity	OFF	OFF	Even	ON	OFF	Odd	OFF	ON	None									
SW6	SW7	Parity																					
OFF	OFF	Even																					
ON	OFF	Odd																					
OFF	ON	None																					
SW8	Priority setting	OFF: DIP switch setting ON: RS-485 communication setting	CT/5ACT setting																				
SW9 SW10	Circuit setting	<table border="1"> <thead> <tr> <th>SW6</th> <th>SW7</th> <th>Circuit</th> </tr> </thead> <tbody> <tr> <td>OFF</td> <td>OFF</td> <td>Three-phase three-wire</td> </tr> <tr> <td>ON</td> <td>OFF</td> <td>Single-phase two-wire</td> </tr> <tr> <td>OFF</td> <td>ON</td> <td>Single-phase three-wire</td> </tr> </tbody> </table>	SW6	SW7	Circuit	OFF	OFF	Three-phase three-wire	ON	OFF	Single-phase two-wire	OFF	ON	Single-phase three-wire	Set this switch correctly according to the measurement environment. Otherwise, measurement cannot be performed correctly.								
SW6	SW7	Circuit																					
OFF	OFF	Three-phase three-wire																					
ON	OFF	Single-phase two-wire																					
OFF	ON	Single-phase three-wire																					

Unit No. setting switch

UNIT No.	Setting Data	Remarks
	00 to 99	

Available Memory

The available memory setting range varies depending on the PLC model. Be sure to set within the range available for the PLC. Use [TYPE] when assigning the indirect memory for macro programs.

Memory	TYPE	Remarks
C0 Variable area (instantaneous value)	00H	Double-word, read only
C2 Variable area (maximum value)	02H	Double-word, read only
C3 Variable area (minimum value)	03H	Double-word, read only
C000 Parameter area	04H	Double-word

Indirect Memory Designation

	15	8 7	0
n + 0	Model (91 to 98)	Memory type	
n + 1	Address No.		
n + 2	Expansion code	Bit designation	
n + 3	00	Station number	

For bit designation, an expansion code setting is required.

00H: when designating bit 0 to 15

01H: when designating bit 16 to 31

PLC_CTL

Macro command "PLC_CTL F0 F1 F2"

Contents	F0	F1 (= \$u n)	F2
Status read out	1 - 8 (PLC1 - 8)	n	Station number
		n + 1	Command: 06H
		n + 2	Operation status
Operation instructions	1 - 8 (PLC1 - 8)	n	Station number *1
		n + 1	Command: 30H
		n + 2	0300H: Integral power consumption zero reset 1200H: Maximum of each measurement value reset 1300H: Minimum of each measurement value reset 9900H: Software reset

 Return data: Data stored from temperature controller to TS series

*1 8000 (HEX): broadcasting

30.2.14 KM100

Communication Setting

Editor

Communication setting

(Underlined setting: default)

Item	Setting	Remarks
Connection Mode	1 : 1 / <u>1:n</u> / Multi-link2 / Multi-link2 (Ethernet)	
Signal Level	RS-232C / <u>RS-422/485</u>	
Baud Rate	4800 / <u>9600</u> / 19200 / 38400 bps	
Data Length	<u>7</u> / 8 bits	
Stop Bit	1 / <u>2</u> bits	
Parity	None / Odd / <u>Even</u>	
Target Port No.	<u>0</u> to 99	

Temperature Controller

Communication level

Move to the communication setting level by using the key on the operation panel and make the required settings.

When the [LEVEL] key is held down for three seconds or longer in the run level, the setting level is selected.

When the [LEVEL] key is pressed in the setting level, the communication setting level is selected.

When the [LEVEL] key is held down for one second or longer, the run level is selected again.

(Underlined setting: default)

Item	Setting	Remarks
Communication unit No.	U-no 00 to 99	
Baud rate	bPS 4800 / <u>9600</u> / 19200 / 38400	
Data length	LEn <u>7</u> / 8	
Stop bit	Sbit 1 / <u>2</u>	
Parity	Prt None / <u>Even</u> / Odd	

Available Memory

The available memory setting range varies depending on the PLC model. Be sure to set within the range available for the PLC. Use [TYPE] when assigning the indirect memory for macro programs.

Memory	TYPE	Remarks
C0 Variable area (instantaneous value)	00H	Double-word, read only
C1 Variable area (average value)	01H	Double-word, read only
C2 Variable area (maximum value)	02H	Double-word, read only
C000 Parameter area	04H	Double-word

Indirect Memory Designation

	15	8 7	0
n + 0	Model (91 to 98)		Memory type
n + 1	Address No.		
n + 2	Expansion code		Bit designation
n + 3	00		Station number

For bit designation, an expansion code setting is required.

00H: when designating bit 0 to 15

01H: when designating bit 16 to 31

PLC_CTL

Macro command "PLC_CTL F0 F1 F2"

Contents	F0	F1 (= \$u n)		F2
Status read out	1 - 8 (PLC1 - 8)	n	Station number	2
		n + 1	Command: 06H	
		n + 2	Operation status	
Operation instructions	1 - 8 (PLC1 - 8)	n	Station number *1	3
		n + 1	Command: 30H	
		n + 2	0000H: Start calculation of arbitrary integral power consumption	
			0100H: Stop calculation of arbitrary integral power consumption	
			0200H: Arbitrary integral power consumption zero reset	
			0300H: Integral power consumption zero reset	
			0700H: Move to setting level	
			Log data read out	
			1000H: Moving the read pointer to the top of the stored data	
		1001H: Reading the log data at the read pointer (The pointer advances.)		
1002H: Reading the log data at the read pointer and delete the read data and earlier data from the memory (The pointer advances.)				
1100H: Delete all log data				
9900H: Software reset				

 Return data: Data stored from temperature controller to TS series

*1 8000 (HEX): broadcasting

30.2.15 Wiring Diagrams

When Connected at COM1:

RS-422/RS-485

Wiring diagram 1 - COM1

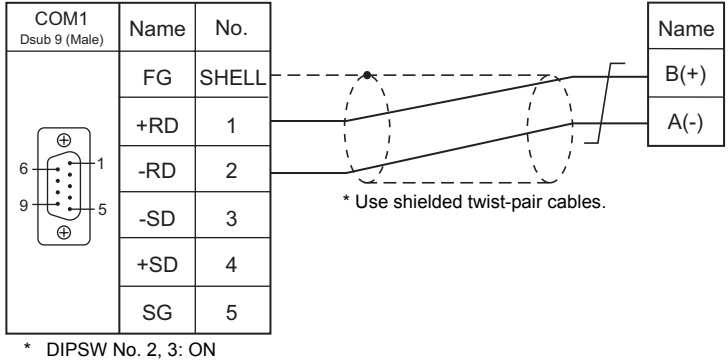

Wiring diagram 2 - COM1

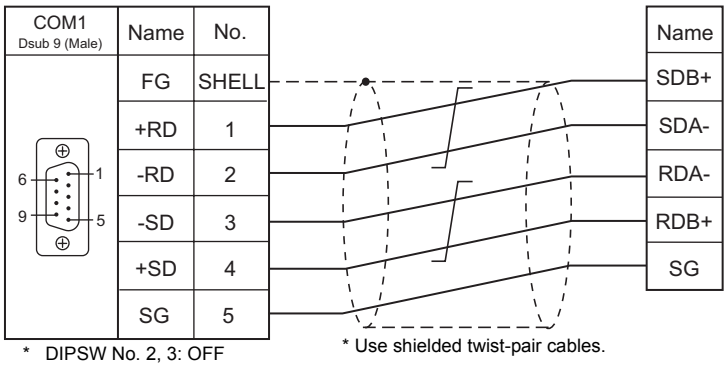

Wiring diagram 3 - COM1

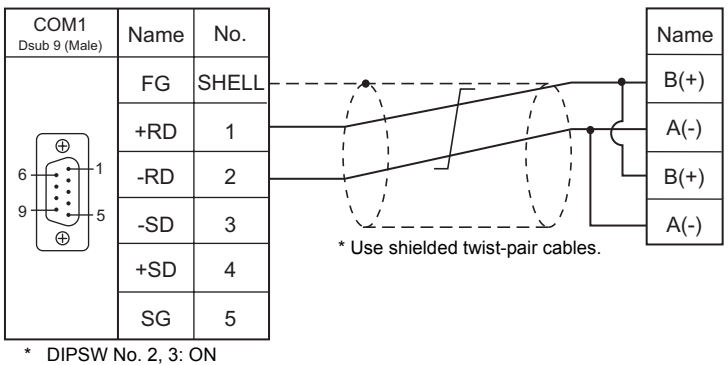

Wiring diagram 4 - COM1

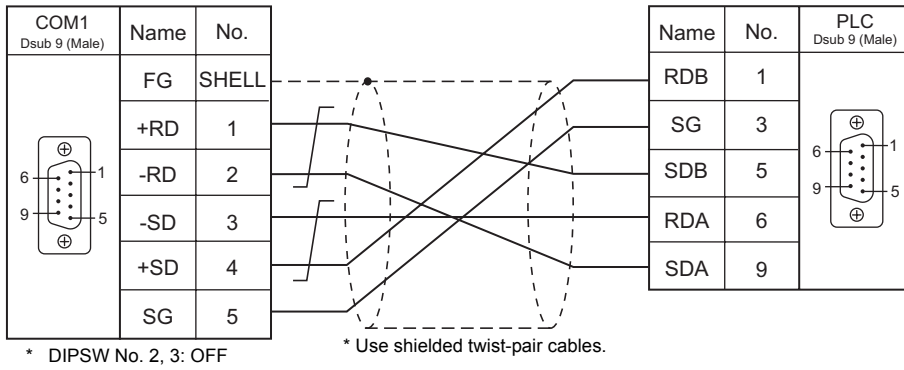

Wiring diagram 5 - COM1

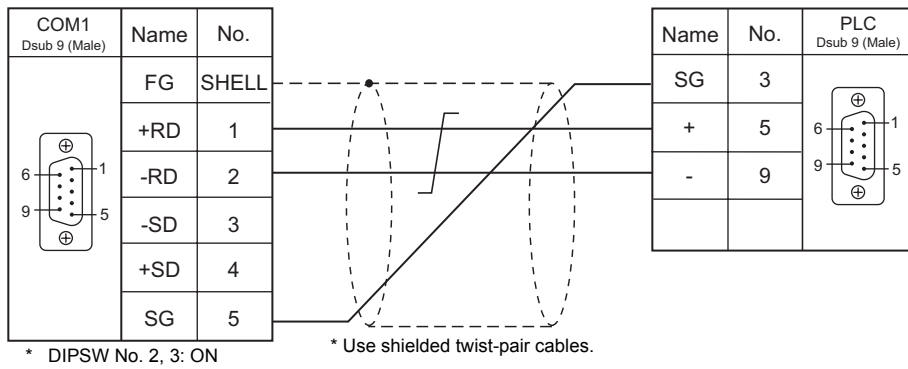

When Connected at COM2:

RS-232C

Wiring diagram 1 - COM2

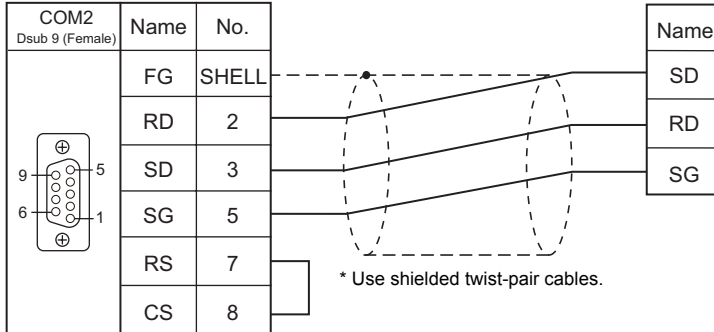

Wiring diagram 2 - COM2

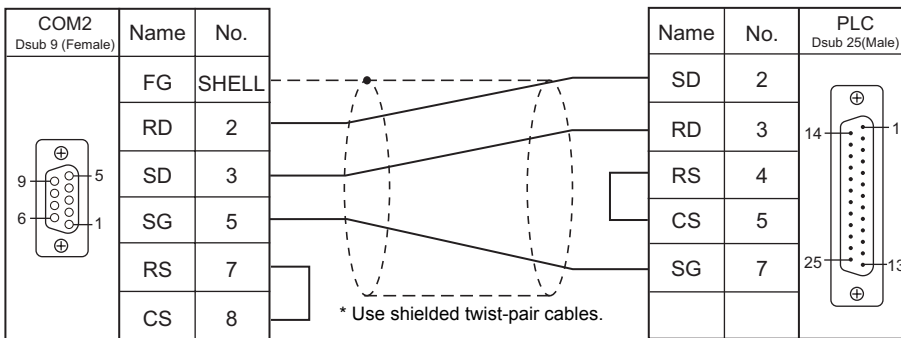

Wiring diagram 3 - COM2

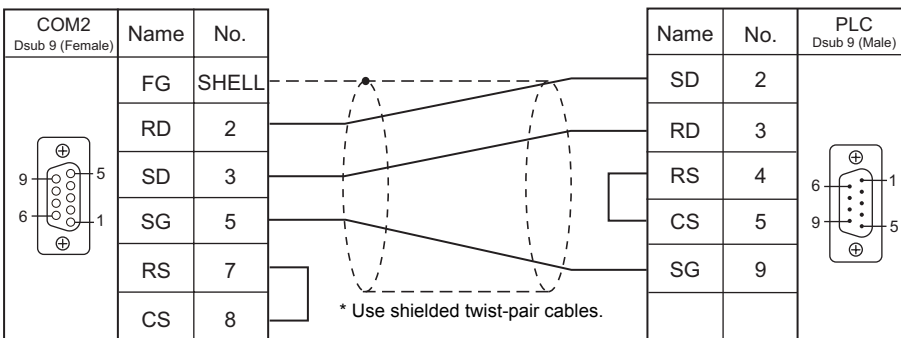

Wiring diagram 4 - COM2

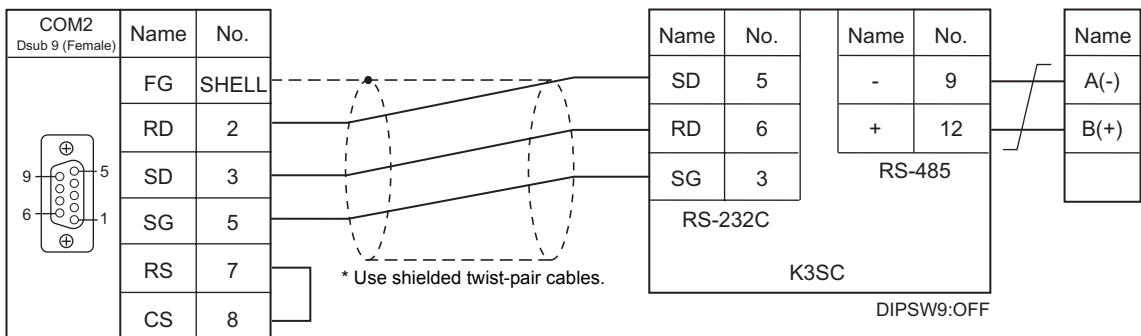

When Connected at COM3:

RS-485

Wiring diagram 1 - COM3

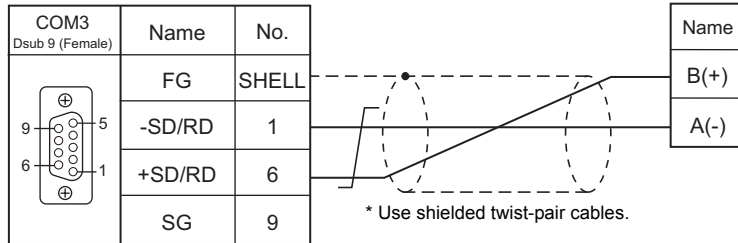

Wiring diagram 2 - COM3

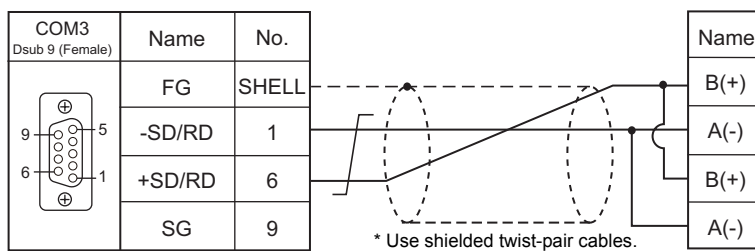

Wiring diagram 3 - COM3

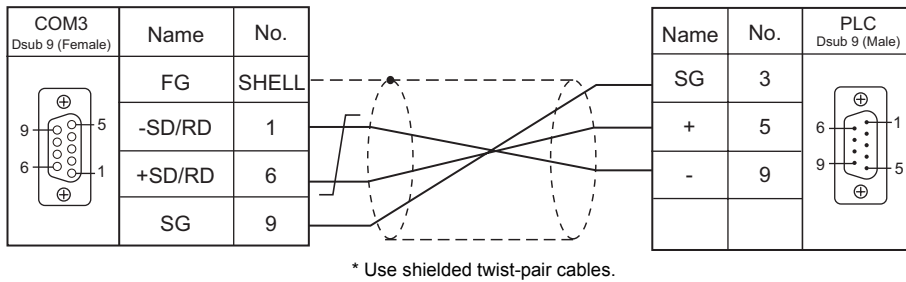

Wiring diagram 4 - COM3

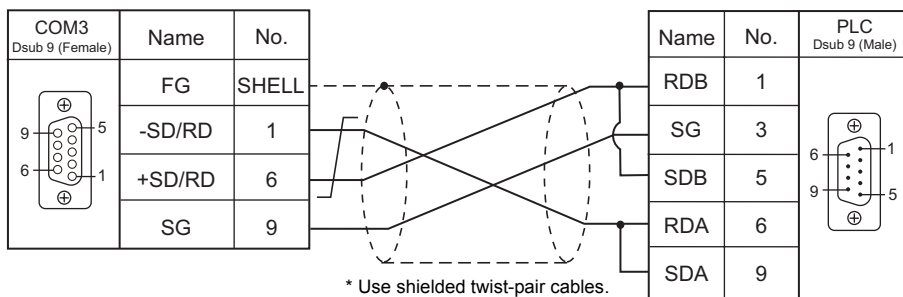

MEMO

Please use this page freely.

31. Oriental Motor

31.1 Temperature Controller / Servo / Inverter Connection

31.1 Temperature Controller / Servo / Inverter Connection

Stepping Motor

PLC Selection on the Editor	Model	Port	Signal Level	TS Port	Connection	Lst File
High-efficiency AR series (MODBUS RTU)	ARD-KD ARD-AD ARD-CD	CN6 CN7	RS-485	COM1	Wiring diagram 1 - COM1	OM_AR (MODBUS RTU).Lst
				COM3	Wiring diagram 1 - COM3	
CRK series (MODBUS RTU)	CRD503-KD CRD507-KD CRD507H-KD CRD514-KD	CN6 CN7	RS-485	COM1	Wiring diagram 1 - COM1	OM_CRK (MODBUS RTU).Lst
				COM3	Wiring diagram 1 - COM3	

31.1.1 High-efficiency AR Series (MODBUS RTU)

Communication Setting

Editor

Communication setting

(Underlined setting: default)

Item	Setting	Remarks
Connection Mode	1 : 1 / <u>1:n</u> / Multi-link2 / Multi-link2 (Ethernet) / 1 : n Multi-link2 (Ethernet)	
Signal Level	<u>RS-422/485</u>	
Baud Rate	9600 / 19200 / 38400 / 57600 / <u>115K</u> bps	
Data Length	<u>8</u> bits	
Stop Bit	<u>1</u> / 2 bits	
Parity	None / Odd / <u>Even</u>	
Target Port No.	0 to 31	0: Broadcast

Stepping Motor

ARD-AD/ARD-CD

MEXE02 (application software)

Setting changes will take effect after turning the power off and back on. If changes are made to any settings, turn the power off and on again.

(Underlined setting: default)

Item	Setting	Remarks
Communication timeout	<u>0</u> to 10000 ms	0: No check * If the TS series performs no communication for a set timeout period (other than "0"), an alarm occurs at the stepping motor.
Parity	None / <u>Even</u> / Odd	
Stop bit	<u>1</u> / 2 bits	

Baud rate setting switch (SW2)

SW2	Setting Item	Setting	Remarks
	Baud rate	0: 9600 bps 1: 19200 bps 2: 38400 bps 3: 57600 bps 4: 115200 bps	5 to F disabled

Function setting switches (SW4)

SW4	No.	Setting Item	Setting	Remarks
	1	Device number setting	OFF: 1 to 15 ON: 16 to 31	Use this switch together with the device number setting switch (ID).
	2	Protocol setting	ON: MODBUS protocol	

Device number setting switch (ID)

ID	Setting Item	Setting			Remarks
	Device number	Device No.	Device Number Setting Switch (ID)	Function Setting Switch (SW4) No. 1	Use this switch together with function setting switch (SW4) No. 1. * Do not use device No. 0.
		1 to 15	1 to F	OFF	
		16 to 31	0 to F	ON	

Terminating resistance setting switches (TERM.)

TERM.	Setting Item	Setting	Remarks
	Terminating resistance	Both ON: With terminating resistance	Be sure to set both switches to the same position (ON or OFF). Turning ON either one only may result in communication error.
		Both OFF: Without terminating resistance	

ARD-KD**MEXE02 (application software)**

Setting changes will take effect after turning the power off and back on. If changes are made to any settings, turn the power off and on again.

(Underlined setting: default)

Item	Setting	Remarks
Communication timeout*	0 to 10000 ms	0: No check * If the TS series performs no communication for a set timeout period (other than "0"), an alarm occurs at the stepping motor.
Parity	None / <u>Even</u> / Odd	
Stop bit	<u>1</u> / 2 bits	

Device number setting switch (SW1)

SW1	Setting Item	Setting	Remarks									
	Device number	<table border="1"> <thead> <tr> <th>Device No.</th> <th>Device Number Setting Switch (ID)</th> <th>Function Setting Switch (SW3) No. 1</th> </tr> </thead> <tbody> <tr> <td>1 to 15</td> <td>1 to F</td> <td>OFF</td> </tr> <tr> <td>16 to 31</td> <td>0 to F</td> <td>ON</td> </tr> </tbody> </table>	Device No.	Device Number Setting Switch (ID)	Function Setting Switch (SW3) No. 1	1 to 15	1 to F	OFF	16 to 31	0 to F	ON	Use this switch together with function setting switch (SW3) No. 1. * Do not use device No. 0.
		Device No.	Device Number Setting Switch (ID)	Function Setting Switch (SW3) No. 1								
		1 to 15	1 to F	OFF								
16 to 31	0 to F	ON										

Baud rate setting switch (SW2)

SW2	Setting Item	Setting	Remarks
	Baud rate	0: 9600 bps 1: 19200 bps 2: 38400 bps 3: 57600 bps 4: 115200 bps	5 to F disabled

Function setting switches (SW3)

SW3	No.	Setting Item	Setting	Remarks
	1	Device number setting	OFF: 1 to 15 ON: 16 to 31	Use this switch together with the device number setting switch (SW1).
	2	Protocol setting	ON: MODBUS protocol	
	3	Not used	OFF	
	4	Terminating resistance	ON: With terminating resistance OFF: Without terminating resistance	

Available Memory

The available memory setting range varies depending on the models. Be sure to set within the range available for the device. Use [TYPE] when assigning the indirect memory for macro programs.

Memory	TYPE	Remarks
4 (holding register)	02H	

31.1.2 CRK Series (MODBUS RTU)

Communication Setting

Editor

Communication setting

(Underlined setting: default)

Item	Setting	Remarks
Connection Mode	1 : 1 / <u>1:n</u> / Multi-link2 / Multi-link2 (Ethernet) / 1 : n Multi-link2 (Ethernet)	
Signal Level	<u>RS-422/485</u>	
Baud Rate	9600 / 19200 / 38400 / 57600 / <u>115K</u> bps	
Data Length	<u>8</u> bits	
Stop Bit	<u>1</u> / 2 bits	
Parity	None / Odd / <u>Even</u>	
Target Port No.	0 to 31	0: Broadcast

Stepping Motor

MEXE02 (application software)

Setting changes will take effect after turning the power off and back on. If changes are made to any settings, turn the power off and on again.

(Underlined setting: default)

Item	Setting	Remarks
Communication device number	1 to 31	This setting is valid, provided that the device number setting switch (SW1) is set to "F". * Do not use device No. 0.
Communication protocol	Modbus RTU	
Parity	None / <u>Even</u> / Odd	
Stop bit	<u>1</u> / 2 bits	
Communication timeout	<u>0</u> to 10000 ms	0: No check * If the TS series performs no communication for a set timeout period (other than "0"), an alarm occurs at the stepping motor.

Device number setting switch (SW1)

SW1	Setting Item	Setting	Remarks
	Device number	1 to E: 1 to 14	Do not use device No. 0.
		F: Device number of the communication device number parameter in MEXE02	

Function setting switches (SW2)

SW2	No.	Setting Item	Setting	Remarks																								
	1	Baud rate	<table border="1"> <thead> <tr> <th></th> <th>No. 1</th> <th>No. 2</th> <th>No. 3</th> </tr> </thead> <tbody> <tr> <td>9600 bps</td> <td>OFF</td> <td>OFF</td> <td>OFF</td> </tr> <tr> <td>19200 bps</td> <td>ON</td> <td>OFF</td> <td>OFF</td> </tr> <tr> <td>38400 bps</td> <td>OFF</td> <td>ON</td> <td>OFF</td> </tr> <tr> <td>57600 bps</td> <td>ON</td> <td>ON</td> <td>OFF</td> </tr> <tr> <td>115200 bps</td> <td>OFF</td> <td>OFF</td> <td>ON</td> </tr> </tbody> </table>		No. 1	No. 2	No. 3	9600 bps	OFF	OFF	OFF	19200 bps	ON	OFF	OFF	38400 bps	OFF	ON	OFF	57600 bps	ON	ON	OFF	115200 bps	OFF	OFF	ON	
			No. 1	No. 2	No. 3																							
	9600 bps		OFF	OFF	OFF																							
	19200 bps		ON	OFF	OFF																							
38400 bps	OFF	ON	OFF																									
57600 bps	ON	ON	OFF																									
115200 bps	OFF	OFF	ON																									
2																												
3																												
4	Connected device	ON: Universal master device																										

Terminating resistance setting switch (SW3)

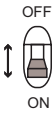
SW3	Setting Item	Setting	Remarks
	Terminating resistance	ON: With terminating resistance OFF: Without terminating resistance	

Available Memory

The available memory setting range varies depending on the models. Be sure to set within the range available for the device. Use [TYPE] when assigning the indirect memory for macro programs.

Memory	TYPE	Remarks
4 (holding register)	02H	

31.1.3 Wiring diagram

When Connected at COM1:

RS-485

Wiring diagram 1 - COM1

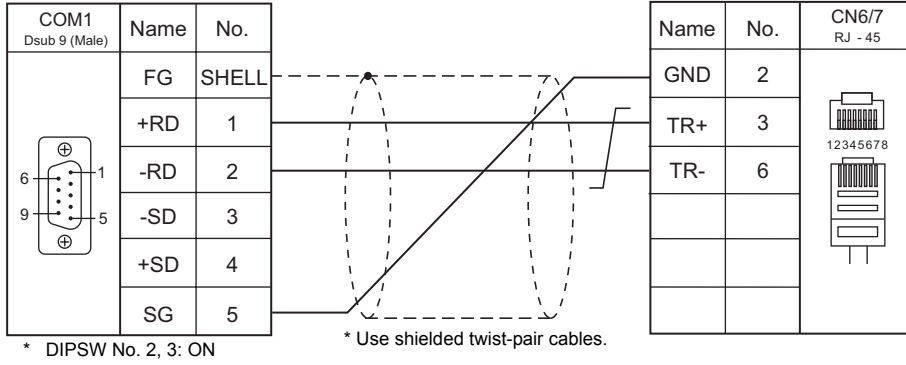

When Connected at COM3:

RS-485

Wiring diagram 1 - COM3

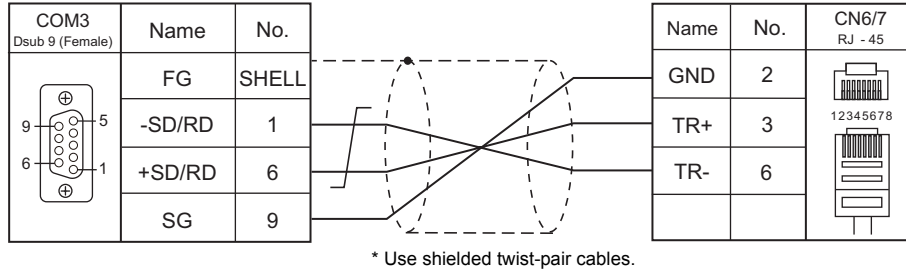

32. Panasonic

32.1 PLC Connection

32.2 Temperature Controller/Servo/Inverter Connection

32.1 PLC Connection

Serial Connection

PLC Selection on the Editor	CPU	Unit/Port	Signal Level	TS Port	Connection	Ladder Transfer ^{*1}	
FP Series (RS232C/422)	FP1	COM port of the CPU	RS-232C	COM2	Wiring diagram 1 - COM2	×	
	FP3	AFP3462 (CCU)	RS-232C				
		AFP3463 (C-NET)	RS-485	COM1	Wiring diagram 1 - COM1		
	FP5	AFP5462 (CCU)	RS-232C	COM2	Wiring diagram 1 - COM2		
							COM3
	FP10	COM port of the CPU	RS-232C	COM2	Wiring diagram 1 - COM2		
		AFP5462 (CCU)	RS-232C				
	FP10S FP10SH	COM port of the CPU	RS-232C	COM2	Wiring diagram 1 - COM2		
		AFP3462 (CCU)	RS-232C				
	FP0	Tool port of the CPU	RS-232C	COM2	Panasonic "AFC8503" + Wiring diagram 6 - COM2	○	
		COM port of the CPU	RS-232C	COM2	Wiring diagram 3 - COM2	×	
	FP2 FP2SH	Tool port of the CPU	RS-232C	COM2	Panasonic "AFC8503" + Wiring diagram 6 - COM2	○	
		COM port of the CPU	RS-232C	COM2	Wiring diagram 2 - COM2	×	
	FPΣ	Tool port of the CPU	RS-232C	COM2	Panasonic "AFC8503" + Wiring diagram 6 - COM2	○	
		AFP801	COM1	RS-232C	COM2	Wiring diagram 4 - COM2	×
		AFP802	COM1, 2	RS-232C	COM2	Wiring diagram 5 - COM2	
		AFP803	COM1	RS-485	COM1	Wiring diagram 2 - COM1	
					COM3	Wiring diagram 2 - COM3	
		AFP806	COM1	RS-485	COM1	Wiring diagram 1 - COM1	
	COM3				Wiring diagram 1 - COM3		
	COM2	COM1	RS-232C	COM2	Wiring diagram 3 - COM2		
				COM2	Wiring diagram 3 - COM2		
	FP-e	Tool port of the CPU	RS-232C	COM2	Panasonic "AFC8503" + Wiring diagram 6 - COM2	○	
		COM port of the CPU	RS-232C	COM2	Wiring diagram 3 - COM2	×	
			RS-485	COM1	Wiring diagram 2 - COM1		
	COM3	Wiring diagram 2 - COM3					
	FP-X	Tool port of the CPU	RS-232C	COM2	Panasonic "AFC8503" + Wiring diagram 6 - COM2	○	
		AFPX-COM1	COM1	RS-232C	COM2	Wiring diagram 4 - COM2	×
AFPX-COM2		COM1, 2	RS-232C	COM2	Wiring diagram 5 - COM2		
AFPX-COM3		COM1	RS-485	COM1	Wiring diagram 1 - COM1		
				COM3	Wiring diagram 1 - COM3		
AFPX-COM4		COM1	RS-485	COM1	Wiring diagram 1 - COM1		
				COM3	Wiring diagram 1 - COM3		
COM2	COM1	RS-232C	COM2	Wiring diagram 3 - COM2			

*1 For the ladder transfer function, see "Appendix 5 Ladder Transfer Function".

Ethernet Connection

FP/FP-X Series

PLC Selection on the Editor	CPU	Unit	TCP/IP	UDP/IP	Port No.	Ladder Transfer *4
FP Series (TCP/IP)*1	FP2	FP2-ET1	○	×	As desired *2	×
FP Series (UDP/IP)			×	○		
FP-X (TCP/IP)	FP-X	AFPX-COM5	○	×	As desired *3	×

*1 To speed up communications, we recommend you to use UDP/IP communication.

*2 Eight connection settings are provided on the PLC; each for one TS unit. Therefore, a maximum of eight TS units can be connected to an Ethernet unit.

*3 A maximum of three units can be connected to one port by setting the "Source Port No." on the PLC communication tool. Therefore, a maximum of three TS units can be connected to an Ethernet unit.

*4 For the ladder transfer function, see "Appendix 5 Ladder Transfer Function".

32.1.1 FP Series (RS232C/422)

Communication Setting

Editor

Communication setting

(Underlined setting: default)

Item	Setting	Remarks
Connection Mode	<u>1</u> :1 / 1 : n / Multi-link / Multi-link2	
Signal Level	<u>RS-232C</u> / RS-422/485	
Baud Rate	4800 / 9600 / <u>19200</u> / 38400 /57600 / 115k bps	
Data Length	7 / <u>8</u> bits	
Stop Bit	<u>1</u> / 2 bits	
Parity	None / <u>Odd</u> / Even	
Target Port No.	0 to 31	
Header	<u>% (Header)</u> / < (Extension Header)	Models on which "< (Extension header)" is available: FP2, FP2SH, FPΣ, FP-X, FP0R
Monitor Registration	Unchecked / <u>Checked</u>	One TS unit can be registered as a monitor for one PLC. When multi-link connection (n : 1) is selected, do not check this box for multiple TS units.

PLC

Be sure to match the settings to those made on the [Communication Setting] tab window of the editor.

FP-X

Tool port setting

(Underlined setting: default)

System Register *1	Contents	
410	Unit No.	<u>1</u> to 99
412	Communication Mode	Computer link
413	Data Length	7 / <u>8</u> bits
	Parity	None / <u>Odd</u> / Even
	Stop Bit	<u>1</u> / 2 bits
415	Baud Rate	4800 / <u>9600</u> / 19200 / 38400 /57600 / 115k bps

*1 System register setting is enabled in the RUN mode.

COM port setting

(Underlined setting: default)

System Register *1		Contents	
COM1	COM2		
410	411	Unit No.	<u>1</u> to 99
412		Operation Mode	Computer link
413	414	Data Length	7 / <u>8</u> bits
		Parity	None / <u>Odd</u> / Even
		Stop Bit	<u>1</u> / 2 bits
415		Baud Rate	4800 / <u>9600</u> / 19200 / 38400 /57600 / 115k bps *2

*1 System register setting is enabled in the RUN mode.

*2 For AFPX COM3, set the switch attached to the back of the cassette as well.
SW1 to 3: ON (RS-485), SW4: ON (terminator ON)

*3 Some restrictions may apply to the communication cassette when the USB port is used on the CPU. For more information, refer to the PLC manual issued by the manufacturer.

FP-Σ**Tool port setting**

(Underlined setting: default)

System Register *1	Contents	
410	Unit No.	<u>1</u> to 99
413	Data Length	7 / <u>8</u> bits
	Parity	None / <u>Odd</u> / Even
	Stop Bit	<u>1</u> / 2 bits
415	Baud Rate	4800 / <u>9600</u> / 19200 / 38400 / 57600 / 115k bps

*1 System register setting is enabled in the RUN mode.

COM port setting

(Underlined setting: default)

System Register *1		Contents	
COM1	COM2		
410	411	Unit No.	<u>1</u> to 99*3
412		Communication Mode	Computer link
413	414	Data Length	7 / <u>8</u> bits
		Parity	None / <u>Odd</u> / Even
		Stop Bit	<u>1</u> / 2 bits
415		Baud Rate	4800 / <u>9600</u> / 19200 / 38400 / 57600 / 115k bps *2

*1 System register setting is enabled in the RUN mode.

*2 For AFP806COM1, set the switch attached to the back of the cassette as well.
SW1 to 2: OFF 19200 bps, ON 115 kbps

*3 In addition to system register setting, the station number setting is also possible with the station number setting switch. For more information, refer to the PLC manual issued by the manufacturer.

FP1 / FP0 / FP-e**Tool port setting**

(Underlined setting: default)

System Register *1	Contents	
411	Data Length	7 / <u>8</u> bits
414	Baud Rate	<u>9600</u> / 19200
-	Parity	Odd (fixed)
-	Stop Bit	1 (fixed)

*1 System register setting is enabled in the RUN mode.

COM port setting

(Underlined setting: default)

System Register *1	Contents	
412	Communication Mode	Computer link
413	Data Length	7 / <u>8</u> bits
	Parity	None / <u>Odd</u> / Even
	Stop Bit	<u>1</u> / 2 bits
414	Baud Rate	4800 / <u>9600</u> / 19200
415	Unit No.	<u>1</u> to 99

*1 System register setting is enabled in the RUN mode.

FP2

Tool port setting

(Underlined setting: default)

System Register *1	Contents	
411	Data Length	7 / <u>8</u> bits
414	Baud Rate *2	4800 / 9600 / <u>19200</u> / 38400 / 57600 / 115200 bps
-	Parity	Odd (fixed)
-	Stop Bit	1 (fixed)

*1 System register setting is enabled in the RUN mode.

*2 Enabled when the DIP switch 1 on the back of the CPU unit is set to the OFF position.

COM port setting

(Underlined setting: default)

System Register *1	Contents	
412	Communication Mode	Computer link
413	Data Length	7 / <u>8</u> bits
	Parity	None / <u>Odd</u> / Even
	Stop Bit	<u>1</u> / 2 bits
414	Baud Rate	4800 / 9600 / <u>19200</u> / 38400 / 57600 / 115200 bps
415	Unit No.	<u>1</u> to 99

*1 System register setting is enabled in the RUN mode.

FP10/FP10S (COM Port)

Operation mode setting switch

(Underlined setting: default)

Switch	Setting	Contents
4	OFF	Baud rate: 19200 bps
5	ON	Data length: 8 bits
6	ON	With parity
7	OFF	Odd
8	OFF	Stop bit 1

Station number setting switch

(Underlined setting: default)

Switch		Setting
The tens place	The ones place	<u>01</u> to 32

FP10SH (COM Port)

Operation mode setting switch (upper)

Switch	Setting	Contents
1	OFF	Not control with a modem
2	OFF	Beginning code STX invalid
3	OFF	Terminating code CR
4	ON	
5	ON	Stop bit 1
6	ON	Odd parity
7	ON	
8	ON	Data length: 8 bits

Operation mode setting switch (lower)

Switch	Setting	Contents
6	ON	Baud rate: 19200 bps
7	ON	
8	OFF	

Station number setting switch (lower)

Switch		Setting
The tens place	The ones place	01 to 32

AFP3462 / AFP5462 (CCU)**DIP switch setting**

Switch	Setting	Contents
1	ON	Baud rate: 19200 bps
2	OFF	
3	OFF	
4	ON	Data length: 8 bits
5	ON	With parity
6	OFF	Odd
7	OFF	Stop bit 1
8	OFF	CS, CD invalid

AFP3463 (C-NET Link Unit)**DIP switch setting**

Switch	Setting	Contents
1	OFF	Baud rate: 19200 bps
2	ON	Data length: 8 bits
3	ON	With parity
4	OFF	Odd
5	OFF	Stop bit 1
6	OFF	-
7	OFF	-
8	OFF	-

Available Memory

The available memory setting range varies depending on the PLC model. Be sure to set within the range available with the PLC to be used. Use [TYPE] when assigning the indirect memory for macro programs.

Memory	TYPE	Remarks
DT (data register)	00H	
X (external input)	01H	WX as word device, read only
Y (external output)	02H	WY as word device
R (internal relay)	03H	WR as word device, including special relays
L (link relay)	04H	WL as word device
LD (link register)	05H	
FL (file register)	06H	FP2, 3, 5, 10 only
SV (timer, counter/set value)	07H	
EV (timer, counter/elapsed time)	08H	
T (timer/contact)	09H	Read only
C (counter/contact)	0AH	Read only

32.1.2 FP Series (TCP/IP)

Communication Setting

Editor

Make the following settings on the editor. For more information, see “Appendix 2 Ethernet”.

- IP address for the TS unit
 - When specified on the screen data:
[System Setting] → [Ethernet Communication] → [Local Port IP Address]
 - When specified on the TS unit:
Main Menu screen → [Ethernet]
- Port number for the TS unit (for communication with PLC)
[System Setting] → [Device Connection Setting] → [Communication Setting]
- Others
[System Setting] → [Device Connection Setting] → [Communication Setting]

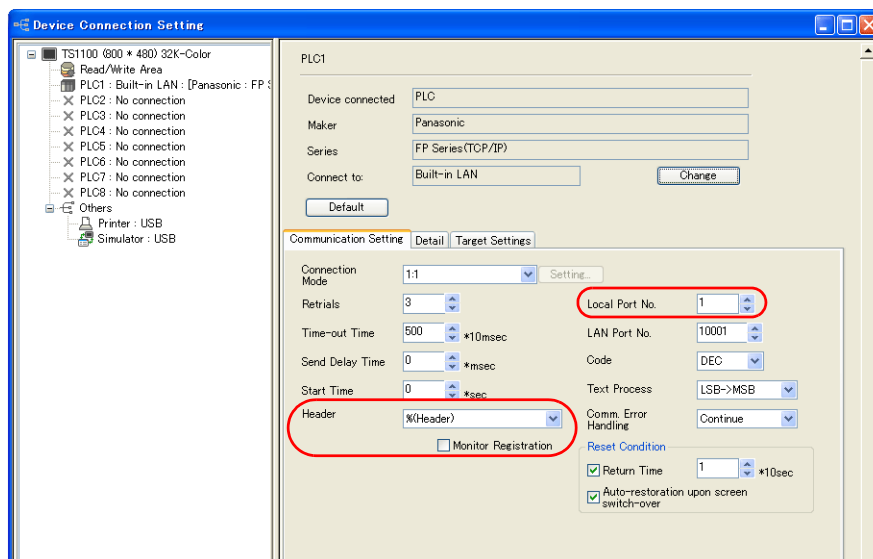

Local Port No.	Set the local port number of the TS unit (1 to 31). Set the same number as the one set for “Target node MEWTOCOL station number” on the [Connection Setting] dialog of the PLC.
Header	Select a format of communication with the PLC. % (Header) / < (Extension Header)
Monitor Registration	Check this box in the case where a monitor registration command is used for communication with the PLC. * One TS unit can be registered as a monitor for one PLC. Do not check this box for multiple TS units in a : 1 connection.

- IP address and port number of the PLC
 [System Setting] → [Device Connection Setting] → [PLC Table]
 Set the same PLC table number as the one set for “MEWTOCOL Station Number” ([Initial Information Setting] → [Local Node Setting]).

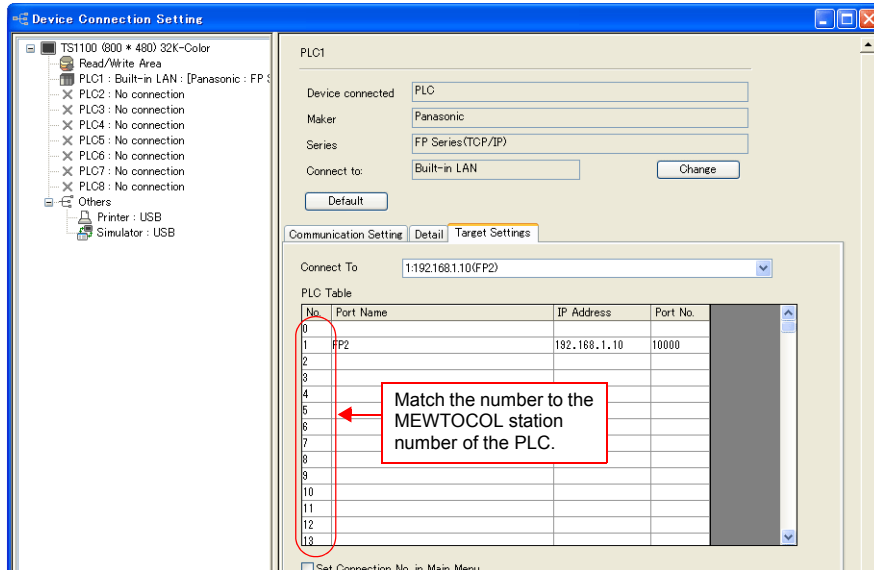

PLC

Make the mode setting using the Ethernet unit “FP2-ET1”.

Mode setting switch

Switch	Setting	Contents	Remarks
2	ON	Auto connection function	

Make the PLC setting using the configuration tool “Configurator ET”. For more information, refer to the PLC manual issued by the manufacturer.

Initial information setting

	Item	Setting
Local Node Setting	IP Address	IP address of the PLC
	MEWTOCOL Station Number	1 to 31 * The same number must be specified for the PLC table number of the TS.

Connection setting

	Item	Setting
Connection 1 to 8 * Select a port to which the TS is connected.	Communication Mode	TCP/IP
	Open Type	Unpassive
	Usage	MEWTOCOL communication
	Local Node (PLC) Port Number	As desired
	Target Node IP Address	IP address of the TS
	Target Node Port Number	Port number of the TS
	Target Node MEWTOCOL Station Number	1 to 31 * Match the number to the one set for [Local Port No.] in the [Communication Setting] tab window on the TS.
	Connection Setting	Valid

Available Memory

The available memory setting range varies depending on the PLC model. Be sure to set within the range available with the PLC to be used. Use [TYPE] when assigning the indirect memory for macro programs.

Memory	TYPE	Remarks
DT (data register)	00H	
X (external input)	01H	WX as word device, read only
Y (external output)	02H	WY as word device
R (internal relay)	03H	WR as word device, including special relays
L (link relay)	04H	WL as word device
LD (link register)	05H	
FL (file register)	06H	FP2, 3, 5, 10 only
SV (timer, counter/set value)	07H	
EV (timer, counter/elapsed time)	08H	
T (timer/contact)	09H	Read only
C (counter/contact)	0AH	Read only

32.1.3 FP Series (UDP/IP)

Communication Setting

Editor

Make the following settings on the editor. For more information, see “Appendix 2 Ethernet”.

- IP address for the TS unit
 - When specified on the screen data:
[System Setting] → [Ethernet Communication] → [Local Port IP Address]
 - When specified on the TS unit:
Main Menu screen → [Ethernet]
- Port number for the TS unit (for communication with PLC)
[System Setting] → [Device Connection Setting] → [Communication Setting]
- Others
[System Setting] → [Device Connection Setting] → [Communication Setting]

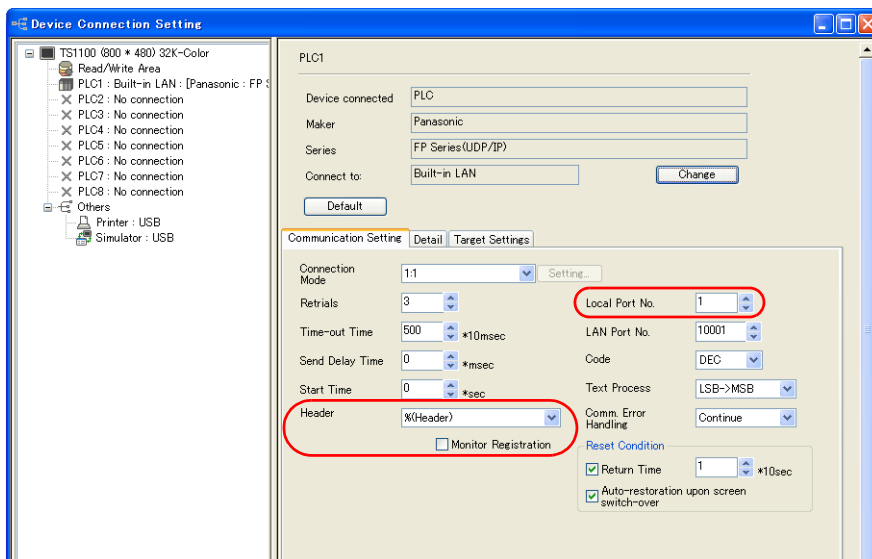

Local Port No.	Set the local port number of the TS unit (1 to 31). Set the same number as the one set for “Target node MEWTOCOL station number” on the [Connection Setting] dialog of the PLC.
Header	Select a format of communication with the PLC. %(Header) / < (Extension Header)
Monitor Registration	Check this box in the case where a monitor registration command is used for communication with the PLC. * One TS unit can be registered as a monitor for one PLC. Do not check this box for multiple TS units in n : 1 connection.

* For settings other than the above, see “1.5.1 PLC1 to PLC8” (page 1-24).

- IP address and port number of the PLC
[System Setting] → [Device Connection Setting] → [PLC Table]
Set the same PLC table number as the one set for “MEWTOCOL Station Number” ([Initial Information Setting] → [Local Node Setting]).

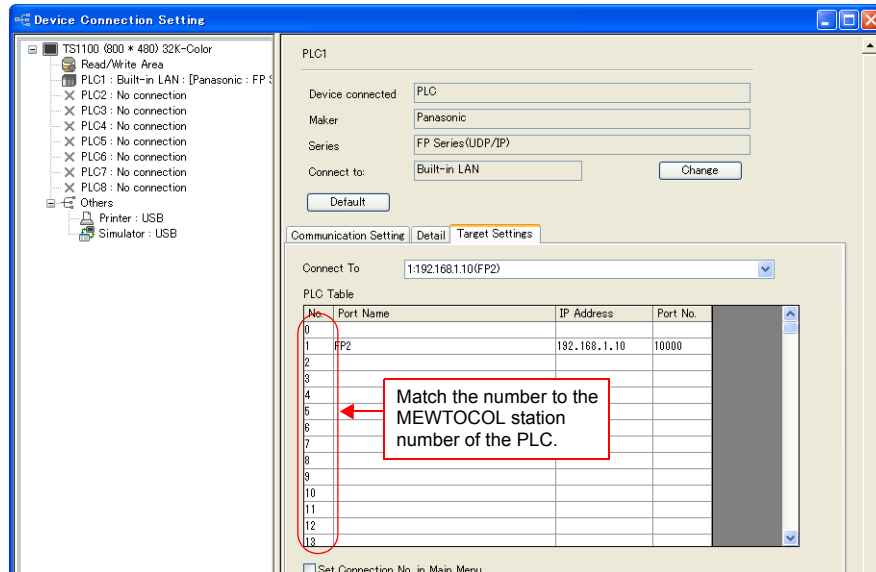

PLC

Make the mode setting using the Ethernet unit “FP2-ET1”.

Mode setting switch

Switch	Setting	Contents	Remarks
2	ON	Auto connection function	

Make the PLC setting using the configuration tool “Configurator ET”. For more information, refer to the PLC manual issued by the manufacturer.

Initial information setting

	Item	Setting
Local Node Setting	IP Address	IP address of the PLC
	MEWTOCOL Station Number	1 to 31 * The same number must be specified for the PLC table number of the TS.

Connection setting

	Item	Setting
Connection 1 to 8 * Select a port to which the TS is connected.	Communication Mode	UDP/IP
	Open Type	Unpassive
	Usage	MEWTOCOL communication
	Local Node (PLC) Port Number	As desired
	Target Node IP Address	IP address of the TS
	Target Node Port Number	Port number of the TS
	Target Node MEWTOCOL Station Number	1 to 31 * Match the number to the one set for [Local Port No.] in the [Communication Setting] tab window on the TS.
	Connection Setting	Valid

Available Memory

The available memory setting range varies depending on the PLC model. Be sure to set within the range available with the PLC to be used. Use [TYPE] when assigning the indirect memory for macro programs.

Memory	TYPE	Remarks
DT (data register)	00H	
X (external input)	01H	WX as word device, read only
Y (external output)	02H	WY as word device
R (internal relay)	03H	WR as word device, including special relays
L (link relay)	04H	WL as word device
LD (link register)	05H	
FL (file register)	06H	FP2, 3, 5, 10 only
SV (timer, counter/set value)	07H	
EV (timer, counter/elapsed time)	08H	
T (timer/contact)	09H	Read only
C (counter/contact)	0AH	Read only

32.1.4 FP-X (TCP/IP)

Communication Setting

Editor

Make the following settings on the editor. For more information, see “Appendix 2 Ethernet”.

- IP address for the TS unit
 - When specified on the screen data:
[System Setting] → [Ethernet Communication] → [Local Port IP Address]
 - When specified on the TS unit:
Main Menu screen → [Ethernet]
- Port number for the TS unit (for communication with PLC)
[System Setting] → [Device Connection Setting] → [Communication Setting]
- Others
[System Setting] → [Device Connection Setting] → [Communication Setting]

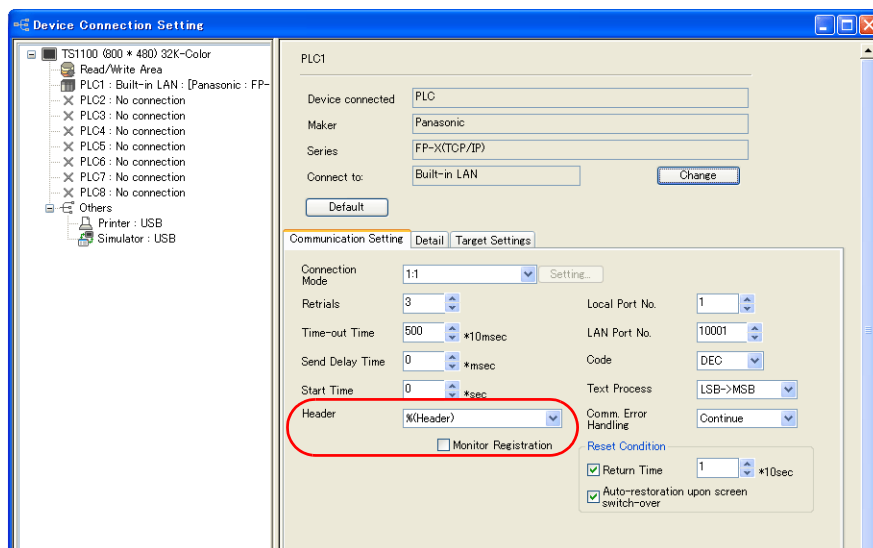

Header	Select a format of communication with the PLC. %(Header) / < (Extension Header)
Monitor Registration	Check this box in the case where a monitor registration command is used for communication with the PLC. * One TS unit can be registered as a monitor for one PLC. Do not check this box for multiple TS units in n : 1 connection.

* For settings other than the above, see “1.5.1 PLC1 to PLC8” (page 1-24).

- IP address and port number of the PLC
 [System Setting] → [Device Connection Setting] → [PLC Table]
 Set the same PLC table number as the one set for “No. 410 Unit No.” ([Option] → [PLC System Register Setting] → [COM1 Port Setting]).

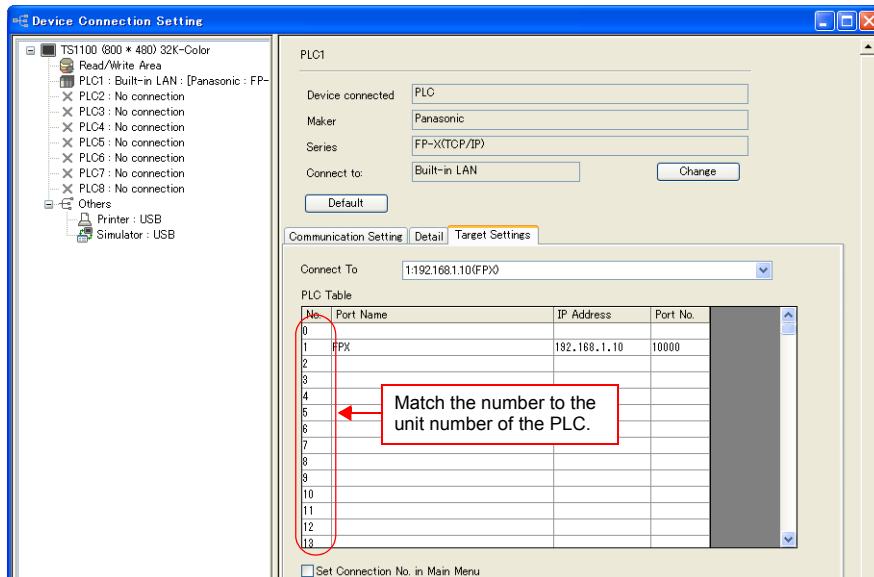

PLC

Make the PLC setting using the communication tool “Configurator WD” and the programming tool “FPWIN GR”. For more information, refer to the PLC manual issued by the manufacturer.

IP address setting (Configurator WD)

Item		Setting
Basic Setting	Unit Name	Unit name of the communication cassette “AFPX-COM5”
	IP Address	IP address of the PLC
	Subnet mask	Subnet mask of the PLC
	Gateway	Gateway of the PLC

Communication setting (Configurator WD)

Item		Setting
Communication Mode		Computer link
Action Mode		Server mode
Control unit - Communication cassette Setting	Baud rate of COM1 Port	9600 / 115200 bps
Server Setting	Source Port No.	As desired

COM1 port setting (FPWIN GP)

Item		Setting
No. 410	Unit No.	1 to 99 * The same number must be specified for the PLC table number of the TS.
No. 412	Communication Mode	Computer link
No. 413	Communication Format	Data Length 8 bits
		Parity Odd
		Stop Bit 1 bit
No. 415	Baud rate	9600 / 115200 bps * Match the baud rate to the one set for “Baud rate of COM1 Port” in the [Control unit - Communication cassette Setting] of the [Communication Setting] dialog on the communication tool “Configurator WD”.

Available Memory

The available memory setting range varies depending on the PLC model. Be sure to set within the range available with the PLC to be used. Use [TYPE] when assigning the indirect memory for macro programs.

Memory	TYPE	Remarks
DT (data register)	00H	
X (external input)	01H	WX as word device, read only
Y (external output)	02H	WY as word device
R (internal relay)	03H	WR as word device, including special relays
L (link relay)	04H	WL as word device
LD (link register)	05H	
FL (file register)	06H	
SV (timer, counter/set value)	07H	
EV (timer, counter/elapsed time)	08H	
T (timer/contact)	09H	Read only
C (counter/contact)	0AH	Read only

32.1.5 Wiring Diagrams

When Connected at COM1:

RS-485

Wiring diagram 1 - COM1

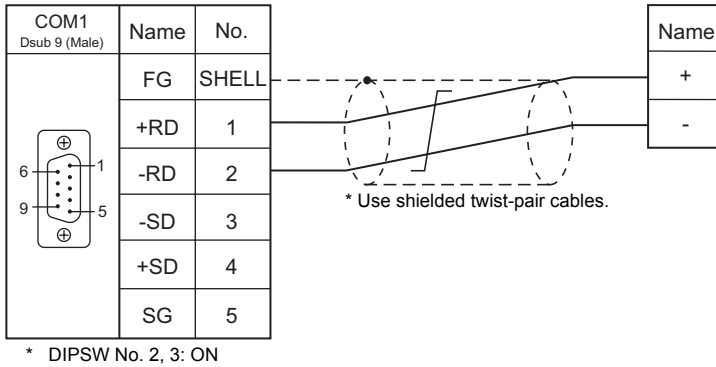

Wiring diagram 2 - COM1

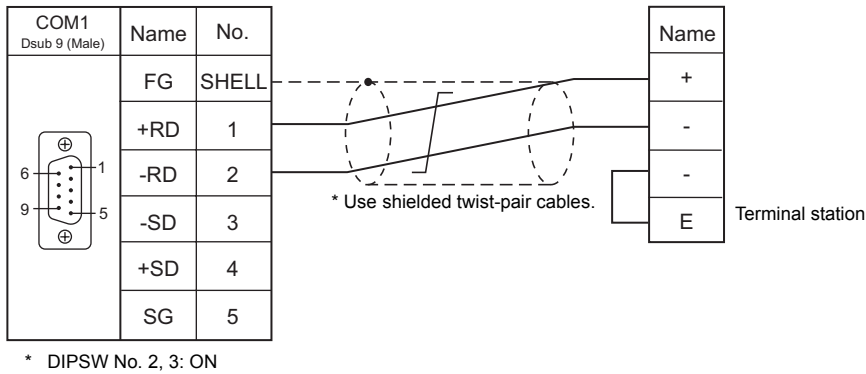

When Connected at COM2:

RS-232C

Wiring diagram 1 - COM2

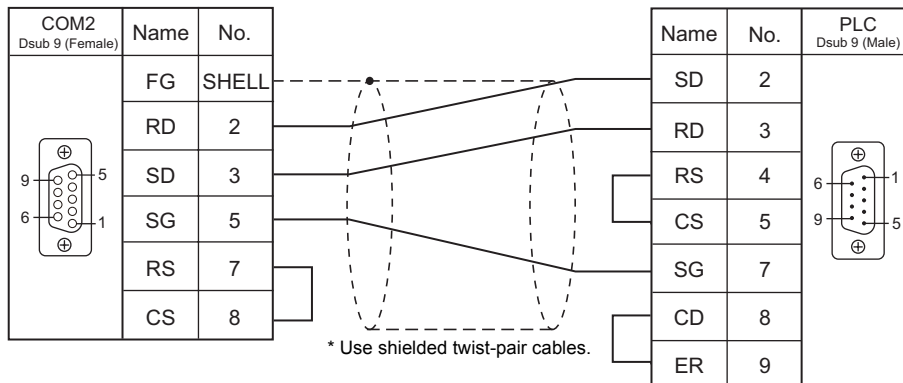

Wiring diagram 2 - COM2

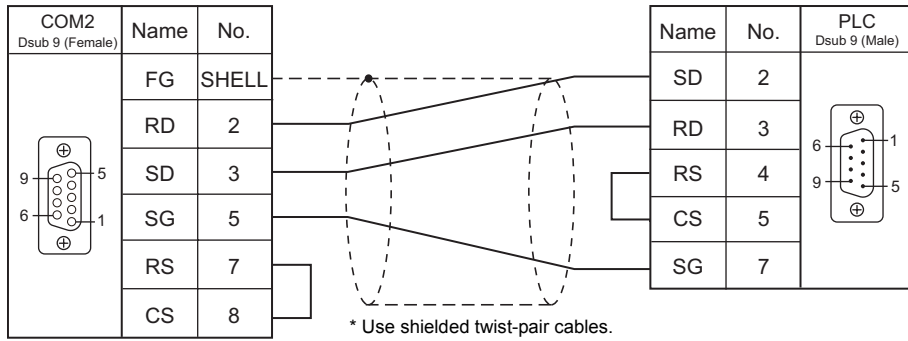

Wiring diagram 3 - COM2

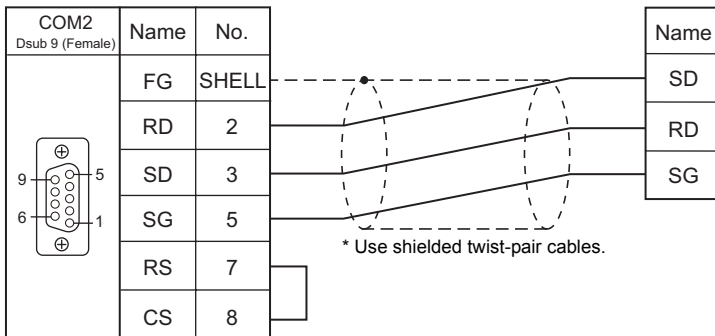

Wiring diagram 4 - COM2

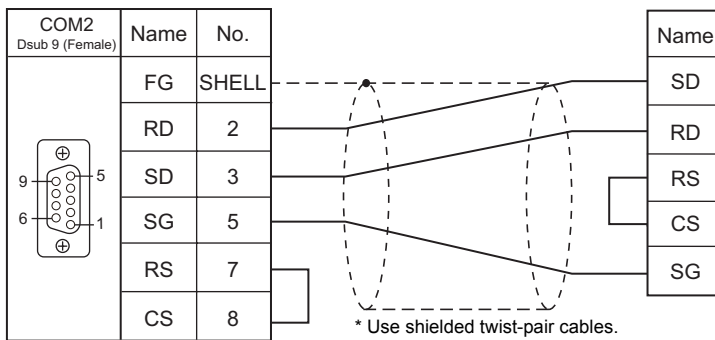

Wiring diagram 5 - COM2

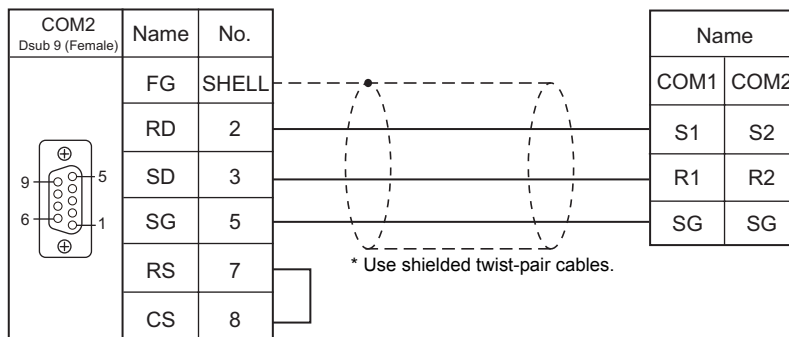

Wiring diagram 6 - COM2

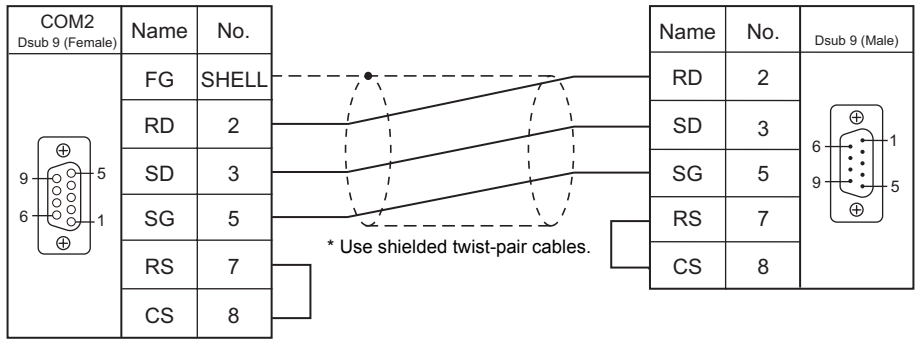

When Connected at COM3:

RS-485

Wiring diagram 1 - COM3

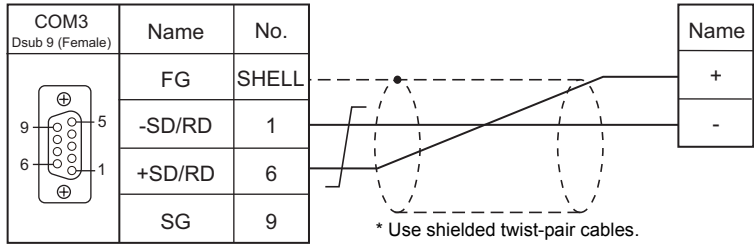

Wiring diagram 2 - COM3

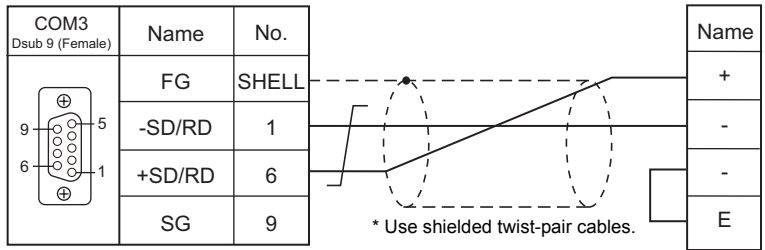

32.2 Temperature Controller/Servo/Inverter Connection

Serial Connection

Laser Marker

PLC Selection on the Editor	Model	Port	Signal Level	TS Port	Connection	Lst File
LP-400	LP-410U, LP-410TU, LP-411U, LP-411TU, LP-420S9U, LP-420S9TU, LP-421S9U, LP-421S9TU, LP-425S9U, LP-425S9TU, LP-430U, LP-430TU, LP-431U, LP-431TU, LP-435U, LP-435TU	COM2	RS-232C	COM2	Wiring diagram 1 - COM2	LP-400.Lst

Eco-POWER METER

PLC Selection on the Editor	Model		Port	Signal Level	TS Port	Connection	Lst File	
KW Series	KW1M	AKW1110 AKW1111	Terminal	RS-485	COM1	Wiring diagram 1 - COM1	Pana_KW1M.Lst	
					COM3	Wiring diagram 1 - COM3		
	KW1M-H	AKW1121	Terminal	RS-485	COM1	Wiring diagram 1 - COM1		
					COM3	Wiring diagram 1 - COM3		
	KW1M-R	AKW1000 AKW1000K	Terminal	RS-232C	COM2	Wiring diagram 2 - COM2		
				RS-485	COM1	Wiring diagram 1 - COM1		
		AKW1131 AKW1131K	Terminal	RS-485	COM1	Wiring diagram 1 - COM1		
					COM3	Wiring diagram 1 - COM3		
	KW2G	AKW2010G	Terminal	RS-485	COM1	Wiring diagram 1 - COM1		Pana_KW2G.Lst
					COM3	Wiring diagram 1 - COM3		
	KW2G-H	AKW2020G	Terminal	RS-485	COM1	Wiring diagram 1 - COM1		
					COM3	Wiring diagram 1 - COM3		
	KW4M	AKW5111 AKW5211	Terminal	RS-485	COM1	Wiring diagram 1 - COM1		Pana_KW4M.Lst
					COM3	Wiring diagram 1 - COM3		
KW7M	AKW7111	Terminal	RS-485	COM1	Wiring diagram 1 - COM1	Pana_KW7M.Lst		
				COM3	Wiring diagram 1 - COM3			
KW8M	AKW8111 AKW8111H AKW8115	Terminal	RS-485	COM1	Wiring diagram 1 - COM1	Pana_KW8M.Lst		
				COM3	Wiring diagram 1 - COM3			

Servo Amplifier

PLC Selection on the Editor	Model	Port	Signal Level	TS Port	Connection	Lst File
MINAS A4 series	MADDTxxxx MBDDTxxxx MCDDTxxxx MDDDTxxxx MEDDTxxxx MFDDTxxxx MGDDTxxxx	CN X4	RS-232C	COM2	Wiring diagram 3 - COM2	PanaA4.Lst
			RS-485	COM1	Wiring diagram 2 - COM1	
				COM3	Wiring diagram 2 - COM3	

32.2.1 LP-400 Series

Communication Setting

Editor

Communication setting

(Underlined setting: default)

Item	Setting	Remarks
Connection Mode	<u>1</u> / 1 / Multi-link2	
Signal Level	<u>RS-232C</u>	
Baud Rate	4800 / <u>9600</u> / 19200 / 38400 bps	
Data Length	<u>8 bits</u>	
Stop Bit	<u>1</u> / 2 bits	
Parity	<u>None</u> / Odd / Even	
Sum Check	Provided / <u>Not provided</u>	
CR/LF	<u>CR</u> / CR/LF	

Laser Marker

Parameter

Set communication parameters using the console. For more information, refer to the instruction manual for the laser marker issued by the manufacturer.

(Underlined setting: default)

Mode	Sub Menu	Item	Setting	Remarks
Environment setting	Communication I/O	Baud Rate	4800 / <u>9600</u> / 19200 / 38400 bps	
		Data Length	<u>8 bit</u>	
		Parity	<u>None</u> / Odd / Even	
		Stop Bits	<u>1</u> / 2 bit	
		Delimit	<u>CR</u> / CR+LF	
		Check Sum	<u>None</u> / Provided	

DIP switch

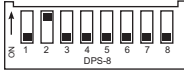
DPS-8	SW No.	Contents	Setting	Remarks												
	1	System reserve	OFF: System reserved													
	2	External control method	ON: RS-232C control													
	3	Buzzer at an occurrence of error	ON: Not sound OFF: Sound													
	4	Password lock	ON: Password lock invalid OFF: Password lock valid													
	5	Method to switch to remote mode	<table border="1"> <thead> <tr> <th>SW5</th> <th>SW6</th> <th>Operation</th> </tr> </thead> <tbody> <tr> <td>OFF</td> <td>OFF</td> <td>Pressing the remote button on the front of the controller</td> </tr> <tr> <td>ON</td> <td>OFF</td> <td>Inputting "REMOTE IN" on the terminal block</td> </tr> <tr> <td>OFF</td> <td>ON</td> <td>Turning the key switch ON</td> </tr> </tbody> </table>	SW5	SW6	Operation	OFF	OFF	Pressing the remote button on the front of the controller	ON	OFF	Inputting "REMOTE IN" on the terminal block	OFF	ON	Turning the key switch ON	
	SW5		SW6	Operation												
	OFF		OFF	Pressing the remote button on the front of the controller												
	ON	OFF	Inputting "REMOTE IN" on the terminal block													
OFF	ON	Turning the key switch ON														
6																
7	System reserve	OFF: System reserved														
8	System reserve	OFF: System reserved														

- * Keep the power off when changing the DIP switch setting.
- * For communications with the TS series, be sure to switch to the remote mode.

Wiring on the terminal block

If printing cannot be performed correctly, check the wiring status on the terminal block.

- Short-circuit A11 "LASER STOP-" and A12 "LASER STOP+". When they are opened, the auto shutter is closed and printing is disabled.
- For B11 "EMER. -" and B12 "EMER. +", connect the normally-closed type emergency stop switch or short-circuit them. When they are opened, the laser power is turned off and printing is disabled.
- Connect the power supply (internal or external) to A2 "IN COM." and B2 "OUT COM.". Otherwise, the laser marker will not be activated.
When using an internal power supply, short-circuit A1 "+12V OUT" and A2 "IN COM." as well as B1 "0V OUT" and B2 "OUT COM.". When using an external power supply, remove short bars from between A1 "+12V OUT" and A2 "IN COM." as well as B1 "0V OUT" and B2 "OUT COM.".

Available Memory

The available memory setting range varies depending on the models. Be sure to set within the range available for the device. Use [TYPE] when assigning the indirect memory for macro programs.

Memory	TYPE	Remarks
FNM (file name)	00H	
FNO (file number change)	01H	
STR (text to print)	02H	
MCS (text to print (1-byte character))	03H	
LMT (limit date and time)	04H	
CNT (counter)	05H	Double-word
LTC (lot condition)	06H	
CDF (logo file)	07H	
ALC (global condition)	08H	Double-word
CDC (logo condition)	09H	Double-word
FST (file setting)	0AH	Double-word
WDC (print line width correction)	0BH	
WTC (print quality adjustment)	0CH	
TRG (trigger condition)	0DH	
DLY (delay)	0EH	
YMD (year, month, day, time)	0FH	
ERA (year of Japanese era)	10H	
ENV (input/output environment)	11H	
PST (print setting)	12H	
STS (status request)	13H	Read only
RKC (rank condition)	14H	
RKS (rank text)	15H	
OFC (offset condition)	16H	
OFS (offset)	17H	Double-word

Memory: FNM (file name)

Address	Name	Setting Range
0000	File name	File name (CHAR 20 bytes)

Memory: FNO (file number)

Address	Name	Setting Range
0000	File number	0 to 1023, 9999 * * 9999: New

Memory: STR (text to print)

Address	Name	Setting Range
0000 to 0029	Text to print in line number 01	Text to print (CHAR 60 bytes)
0030 to 0059	Text to print in line number 02	
:	:	
1770 to 1799	Text to print in line number 60	

Memory: MCS (text to print (1-byte character))

Address	Name	Setting Range
0000 to 0014	Text to print in line number 01 (1-byte character)	Text to print (CHAR 30 bytes)
0015 to 0029	Text to print in line number 02 (1-byte character)	
:	:	
0885 to 0899	Text to print in line number 60 (1-byte character)	

Memory: LMT (limit date and time)

Address	Name	Setting Range
0101	Limit number 1	Limit
0102		Unit
0103		Start day
0201	Limit number 2	Limit
0202		Unit
0203		Start day
:	:	:
0801	Limit number 8	Limit
0802		Unit
0803		Start day

Memory: CNT (counter)

Address	Name	Setting Range
0000	Counter 0	Current value
0001		Initial value
0002		End value
0003		Step
0004		Count source
0005		Flag
0100	Counter 1	Current value
0101		Initial value
0102		End value
0103		Step
0104		Count source
0105		Flag
:	:	:
0700	Counter 7	Current value
0701		Initial value
0702		End value
0703		Step
0704		Count source
0705		Flag

Memory: LTC (lot condition)

Address	Name		Setting Range
0000	Lot function number 0	Lot condition	00: Current 01 to 08: Limit 1 to 8 10 to 17: Counter 0 to 7
0001		Limit condition	0: Year or counter 1: Month 2: Day 3: Year and month 4: Month and day 5: Day of the week 6: Hour 7: Week 8: Minute
0100	Lot function number 1	Lot condition	00: Current 01 to 08: Limit 1 to 8 10 to 17: Counter 0 to 7
0101		Limit condition	0: Year or counter 1: Month 2: Day 3: Year and month 4: Month and day 5: Day of the week 6: Hour 7: Week 8: Minute
:	:	:	:
0700	Lot function number 7	Lot condition	00: Current 01 to 08: Limit 1 to 8 10 to 17: Counter 0 to 7
0701		Limit condition	0: Year or counter 1: Month 2: Day 3: Year and month 4: Month and day 5: Day of the week 6: Hour 7: Week 8: Minute

Memory: CDF (logo file)

Address	Name	Setting Range
0000 to 0127	Name of logo file number 00	Logo file name (CHAR 256 bytes)
0128 to 0255	Name of logo file number 01	
:	:	
1920 to 2047	Name of logo file number 15	

Memory: ALC (global condition)

Address	Name	Setting Range
0000	X offset	LP-430U/430TU/420S9U/420S9TU/410U/410TU -55000 to +55000: -055.000 to +055.000 mm LP-431U/431TU/421S9U/421S9TU/411U/411TU -27500 to +27500: -027.500 to +027.500 mm
0001	Y offset	LP-435U/435TU/425S9U/425S9TU -80000 to +80000: -080.000 to +080.000 mm
0002	Rotation offset	-18000 to +18000: -180.00° to +180.00°
0003	Number of overprint times	1 to 99
0004	Time to stop overprint	0 to 10: 0 to 1.0 sec.
0005	Flip horizontal	0: Not flip 1: Flip
0006	Flip vertical	0: Not flip 1: Flip

Memory: CDC (logo condition)

Address	Name	Setting Range
0000	Area number	0 to F (HEX)
0001	X magnification	10000 to 1000000: 10.000 to 1000.000%
0002	Y magnification	10000 to 1000000: 10.000 to 1000.000%
0003	X position	-300000 to +300000: -300.000 to +300.000 mm
0004	Y position	-300000 to +300000: -300.000 to +300.000 mm
0005	Rotation angle	-18000 to +18000: -180.00° to +180.00°
0006	Laser power offset	0 to 200%
0007	Scan speed correction	5 to 500%
0100	Area number	0 to F (HEX)
0101	X magnification	10000 to 1000000: 10.000 to 1000.000%
0102	Y magnification	10000 to 1000000: 10.000 to 1000.000%
0103	X position	-300000 to +300000: -300.000 to +300.000 mm
0104	Y position	-300000 to +300000: -300.000 to +300.000 mm
0105	Rotation angle	-18000 to +18000: -180.00° to +180.00°
0106	Laser power offset	0 to 200%
0107	Scan speed correction	5 to 500%
:	:	:
1500	Area number	0 to F (HEX)
1501	X magnification	10000 to 1000000: 10.000 to 1000.000%
1502	Y magnification	10000 to 1000000: 10.000 to 1000.000%
1503	X position	-300000 to +300000: -300.000 to +300.000 mm
1504	Y position	-300000 to +300000: -300.000 to +300.000 mm
1505	Rotation angle	-18000 to +18000: -180.00° to +180.00°
1506	Laser power offset	0 to 200%
1507	Scan speed correction	5 to 500%

Memory: FST (file setting)

Address	Name	Setting Range
0000	Laser power (LPW)	0005 to 1000: 000.5 to 100.0 (0.5 increments)
0001	Scan speed (SSP)	LP-430U/430TU/435U/435TU/420S9U/420S9TU/425S9U/ 425S9TU/410U/410TU 00001 to 12000 mm/s LP-431U/431TU/421S9U/421S9TU/411U/411TU 00001 to 06000 mm/s
0002	Frequency (MPL)	0: 5 kHz 1: 10 kHz 2: 20 kHz
0003	Print interval (INT)	00000 to 30000: 0000.0 to 3000.0 mm
0004	Line speed (LSP)	LP-430U/430TU/420S9U/420S9TU/425S9U/425S9TU/ 435U/435TU 60 to 240000: 000.060 to 240.000 m/min LP-431U/431TU/421S9U/421S9TU 60 to 120000: 000.060 to 120.000 m/min LP-410U/410TU 60 to 170000: 000.060 to 170.000 m/min LP-411U/411TU 60 to 85000: 000.060 to 085.000 m/min
0005	Encoder pulse (ENC)	00500 to 60000: 005.00 to 600.00 pulse/mm

Memory: WDC (print line width correction)

Address	Name	Setting Range
0000	Print line width correction	0010 to 2000: 0.010 to 2.000 mm
0001	Filling interval	0010 to 2000: 0.010 to 2.000 mm

Memory: WTC (print quality adjustment)

Address	Name	Setting Range
0000	Laser start point adjustment	-100 to +100
0001	Laser end point adjustment	-100 to +100
0002	Edge adjustment	000 to 100
0003	Curve adjustment	000 to 100
0004	Weight adjustment	000 to 100
0005	Spare scanning time	0000 to 1000: 00.00 to 10.00 msec.

Memory: TRG (trigger condition)

Address	Name	Setting Range
0000	Direction of movement	0: Standstill 1: Left 2: Right 3: Forward 4: Backward
0001	Encoder	0: None 1: Provided
0002	Trigger type	0: Trigger 1: Printing at equal intervals

Memory: DLY (delay)

Address	Name	Setting Range
0000	When "standstill" is specified for movement direction in trigger condition (TRG0000 = 0): Delay distance When any direction other than "standstill" is specified for movement direction in trigger condition (TRG0000 ≈ 0): Delay time	Delay distance 00000 to 50000: 000.00 to 500.00 mm Delay time 000000 to 005000 msec.

Memory: YMD (year, month, day, time)

Address	Name	Setting Range
0000	Year of the Christian era	1980 to 2099
0001	Month	1 to 12
0002	Day	1 to 31
0003	Hour	0 to 23
0004	Minute	0 to 59
0005	Second	0 to 59

Memory: ERA (year of Japanese era)

Address	Name	Setting Range
0000	Year of Japanese era	01 to 99

Memory: ENV (input/output environment)

Address	Name	Setting Range
0000	One-shot time	002 to 510 msec.
0001	Double trigger detection	0: Without output 1: With output

Memory: PST (print setting)

Address	Name	Setting Range
0001	Print mode (MKM)	0: Printing suspend 1: Printing restart
0002	Laser control (LSR)	0: OFF 1: ON

Memory: STS (status request)

Address	Name	Setting Range
0000	Error status	0: No error 1: Error occurring
0001	Laser excitation status	0: Excitation OFF 1: During excitation 2: Excitation finish
0002	Standby status	0: Standby 1: During printing
0003	Print ready status	0: Busy 1: Ready
0004	Trigger status	0: Trigger OFF 1: Trigger ON

Memory: RKC (rank condition)

Address	Name	Setting Range
0000	Parallel input condition	1: 4 bits × 4 2: 8 bits × 2

Memory: RKS (rank text)

Address	Name	Setting Range
0000 to 0008	Set text in rank number 1	Set text (CHAR 18 bytes)
0009 to 0017	Set text in rank number 2	
:	:	
4599 to 4607	Set text in rank number 511	

Memory: OFC (offset condition)

Address	Name	Setting Range
00000	Parallel input condition	0: No offset 1: Lower 4 bits 2: Lower 8 bits

Memory: OFS (offset)

Address		Name	Setting Range
00000	Offset number 0	Offset X	LP-430U/430TU/420S9U/420S9TU/410U/410TU -55000 to +55000: -055.000 to +055.000 mm LP-431U/431TU/421S9U/421S9TU/411U/411TU -27500 to +27500: -027.500 to +027.500 mm LP-435U/435TU/425S9U/425S9TU -80000 to +80000: -080.000 to +080.000 mm
00001		Offset Y	
00002		Offset θ	
00100	Offset number 1	Offset X	LP-430U/430TU/420S9U/420S9TU/410U/410TU -55000 to +55000: -055.000 to +055.000 mm LP-431U/431TU/421S9U/421S9TU/411U/411TU -27500 to +27500: -027.500 to +027.500 mm LP-435U/435TU/425S9U/425S9TU -80000 to +80000: -080.000 to +080.000 mm
00101		Offset Y	
00102		Offset θ	
:		:	:
25500	Offset number 255	Offset X	LP-430U/430TU/420S9U/420S9TU/410U/410TU -55000 to +55000: -055.000 to +055.000 mm LP-431U/431TU/421S9U/421S9TU/411U/411TU -27500 to +27500: -027.500 to +027.500 mm LP-435U/435TU/425S9U/425S9TU -80000 to +80000: -080.000 to +080.000 mm
25501		Offset Y	
25502		Offset θ	

Indirect Memory Designation

	15	8 7	0
n+0	Models (11 to 18)		Memory type
n+1	Address No.		
n+2	Expansion code *		Bit designation
n+3	00		Station number

* In the expansion code, set which word, higher or lower, is to be read when a double-word address is specified.

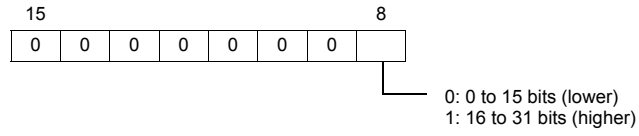

PLC_CTL

Macro command "PLC_CTL F0 F1 F2"

Contents		F0	F1 (= \$u n)		F2	
File overwrite		1 - 8 (PLC1 - 8)	n	Station number: 0 (fixed)	2	
			n + 1	Command: A1H		
File registration		1 - 8 (PLC1 - 8)	n	Station number: 0 (fixed)	3	
			n + 1	Command: A2H		
			n + 2	File number LP-430U/430TU/431U/431TU 0 to 1023 LP-435U/435TU/425S9U/425S9TU/ 420S9U/420S9TU/410U/410TU/ 421S9U/421S9TU/411U/411TU 0 to 2047		
Reading of lot text		1 - 8 (PLC1 - 8)	n	Station number: 0 (fixed)	4	
			n + 1	Command: 23H		
			n + 2	Lot number: 0 to 7		
			n + 3	Period number		
			n + 4 to n + 5	Start of period *1		
			n + 6 to n + 7	End of period *1		
Lot text setting		1 - 8 (PLC1 - 8)	n	Station number: 0 (fixed)	8 + number of words of set text (max. 9 words)	
			n + 1	Command: A3H		
			n + 2	Lot number: 0 to 7		
			n + 3	Period number		
			n + 4 to n + 5	Start of period *2		
			n + 6 to n + 7	End of period *2		
Reading of step & repeat setting	Setting delete	1 - 8 (PLC1 - 8)	n	Station number: 0 (fixed)	3	
			n + 1	Command: 24H		
			n + 2	List line: 00 to 99		
			n + 3	Fine-adjustment type: 0 (setting delete)		
	Single fine-adjustment		1 - 8 (PLC1 - 8)	n	Station number: 0 (fixed)	3
				n + 1	Command: 24H	
				n + 2	List line: 00 to 99	
				n + 3	Fine-adjustment type: 1 (single adjustment)	
				n + 4	Target line: 001 to 100	
				n + 5	Target column: 001 to 100	
	Print OFF		1 - 8 (PLC1 - 8)	n	Station number: 0 (fixed)	3
				n + 1	Command: 24H	
n + 2				List line: 00 to 99		
n + 3				Fine-adjustment type: 2 (print OFF)		
n + 4				Target line: 001 to 100		
			n + 5	Target column: 001 to 100		

*1 When "-1" is set for both start of period and end of period, the reading period is set as undefined.

*2 When writing is executed while "-1" is set for both start of period and end of period, the setting is deleted.

Contents		F0	F1 (= \$u n)		F2	
Reading of step & repeat setting	All columns fine-adjustment	1 - 8 (PLC1 - 8)	n	Station number: 0 (fixed)		3
			n + 1	Command: 24H		
			n + 2	List line: 00 to 99		
			n + 3	Fine-adjustment type: 3 (all columns adjustment)		
			n + 4	Target column: 001 to 100		
			n + 5 to n + 6	X-axis adjustment	LP-430U/430TU/420S9U/420S9TU/410U/410TU -55000 to +55000: -055.000 to +055.000 mm LP-431U/431TU/421S9U/421S9TU/411U/411TU	
	n + 7 to n + 8	Y-axis adjustment	-27500 to +27500: -027.500 to +027.500 mm LP-435U/435TU/425S9U/425S9TU -80000 to +80000: -080.000 to +080.000 mm			
	All lines fine-adjustment	1 - 8 (PLC1 - 8)	n	Station number: 0 (fixed)		3
			n + 1	Command: 24H		
			n + 2	List line: 00 to 99		
			n + 3	Fine-adjustment type: 4 (all lines adjustment)		
			n + 4	Target line: 001 to 100		
			n + 5 to n + 6	X-axis adjustment	LP-430U/430TU/420S9U/420S9TU/410U/410TU -55000 to +55000: -055.000 to +055.000 mm LP-431U/431TU/421S9U/421S9TU/411U/411TU	
	n + 7 to n + 8	Y-axis adjustment	-27500 to +27500: -027.500 to +027.500 mm LP-435U/435TU/425S9U/425S9TU -80000 to +80000: -080.000 to +080.000 mm			
	Column fine-adjustment	1 - 8 (PLC1 - 8)	n	Station number: 0 (fixed)		3
			n + 1	Command: 24H		
n + 2			List line: 00 to 99			
n + 3			Fine-adjustment type: 5 (column adjustment)			
n + 4			Target column: 001 to 100			
n + 5 to n + 6			X-axis adjustment	LP-430U/430TU/420S9U/420S9TU/410U/410TU -55000 to +55000: -055.000 to +055.000 mm LP-431U/431TU/421S9U/421S9TU/411U/411TU		
n + 7 to n + 8	Y-axis adjustment	-27500 to +27500: -027.500 to +027.500 mm LP-435U/435TU/425S9U/425S9TU -80000 to +80000: -080.000 to +080.000 mm				
Line fine-adjustment	1 - 8 (PLC1 - 8)	n	Station number: 0 (fixed)		3	
		n + 1	Command: 24H			
		n + 2	List line: 00 to 99			
		n + 3	Fine-adjustment type: 6 (line adjustment)			
		n + 4	Target line: 001 to 100			
		n + 5 to n + 6	X-axis adjustment	LP-430U/430TU/420S9U/420S9TU/410U/410TU -55000 to +55000: -055.000 to +055.000 mm LP-431U/431TU/421S9U/421S9TU/411U/411TU		
n + 7 to n + 8	Y-axis adjustment	-27500 to +27500: -027.500 to +027.500 mm LP-435U/435TU/425S9U/425S9TU -80000 to +80000: -080.000 to +080.000 mm				

Contents		F0	F1 (= \$u n)		F2	
Writing of step & repeat setting	Setting delete	1 - 8 (PLC1 - 8)	n	Station number: 0 (fixed)		4
			n + 1	Command: A4H		
			n + 2	List line: 00 to 99		
			n + 3	Fine-adjustment type: 0 (setting delete)		
	Single fine-adjustment	1 - 8 (PLC1 - 8)	n	Station number: 0 (fixed)		10
			n + 1	Command: A4H		
			n + 2	List line: 00 to 99		
			n + 3	Fine-adjustment type: 1 (single adjustment)		
			n + 4	Target line: 001 to 100		
			n + 5	Target column: 001 to 100		
	n + 6 to n + 7	X-axis adjustment	LP-430U/430TU/420S9U/420S9TU/410U/410TU -55000 to +55000: -055.000 to +055.000 mm LP-431U/431TU/421S9U/421S9TU/411U/411TU -27500 to +27500: -027.500 to +027.500 mm			
		Y-axis adjustment	LP-435U/435TU/425S9U/425S9TU -80000 to +80000: -080.000 to +080.000 mm			
	Print OFF	1 - 8 (PLC1 - 8)	n	Station number: 0 (fixed)		6
			n + 1	Command: A4H		
			n + 2	List line: 00 to 99		
			n + 3	Fine-adjustment type: 2 (print OFF)		
			n + 4	Target line: 001 to 100		
			n + 5	Target column: 001 to 100		
	All columns fine-adjustment	1 - 8 (PLC1 - 8)	n	Station number: 0 (fixed)		9
			n + 1	Command: A4H		
			n + 2	List line: 00 to 99		
			n + 3	Fine-adjustment type: 3 (all columns adjustment)		
			n + 4	Target column: 001 to 100		
			n + 5 to n + 6	X-axis adjustment	LP-430U/430TU/420S9U/420S9TU/410U/410TU -55000 to +55000: -055.000 to +055.000 mm LP-431U/431TU/421S9U/421S9TU/411U/411TU -27500 to +27500: -027.500 to +027.500 mm	
Y-axis adjustment	LP-435U/435TU/425S9U/425S9TU -80000 to +80000: -080.000 to +080.000 mm					
All lines fine-adjustment	1 - 8 (PLC1 - 8)	n	Station number: 0 (fixed)		9	
		n + 1	Command: A4H			
		n + 2	List line: 00 to 99			
		n + 3	Fine-adjustment type: 4 (all lines adjustment)			
		n + 4	Target line: 001 to 100			
		n + 5 to n + 6	X-axis adjustment	LP-430U/430TU/420S9U/420S9TU/410U/410TU -55000 to +55000: -055.000 to +055.000 mm LP-431U/431TU/421S9U/421S9TU/411U/411TU -27500 to +27500: -027.500 to +027.500 mm		
Y-axis adjustment	LP-435U/435TU/425S9U/425S9TU -80000 to +80000: -080.000 to +080.000 mm					

Contents		F0	F1 (= \$u n)		F2	
Writing of step & repeat setting	Column fine-adjustment	1 - 8 (PLC1 - 8)	n	Station number: 0 (fixed)		9
			n + 1	Command: A4H		
			n + 2	List line: 00 to 99		
			n + 3	Fine-adjustment type: 5 (column adjustment)		
			n + 4	Target column: 001 to 100		
			n + 5 to n + 6	X-axis adjustment	LP-430U/430TU/420S9U/420S9TU/ 410U/410TU -55000 to +55000: -055.000 to +055.000 mm LP-431U/431TU/421S9U/421S9TU/ 411U/411TU -27500 to +27500: -027.500 to +027.500 mm	
			n + 7 to n + 8	Y-axis adjustment	LP-435U/435TU/425S9U/425S9TU -80000 to +80000: -080.000 to +080.000 mm	
			n + 5 to n + 6	X-axis adjustment	LP-430U/430TU/420S9U/420S9TU/ 410U/410TU -55000 to +55000: -055.000 to +055.000 mm LP-431U/431TU/421S9U/421S9TU/ 411U/411TU -27500 to +27500: -027.500 to +027.500 mm	
	n + 7 to n + 8	Y-axis adjustment	LP-435U/435TU/425S9U/425S9TU -80000 to +80000: -080.000 to +080.000 mm			
	Line fine-adjustment	1 - 8 (PLC1 - 8)	n	Station number: 0 (fixed)		9
			n + 1	Command: A4H		
			n + 2	List line: 00 to 99		
			n + 3	Fine-adjustment type: 6 (line adjustment)		
			n + 4	Target line: 001 to 100		
n + 5 to n + 6			X-axis adjustment	LP-430U/430TU/420S9U/420S9TU/ 410U/410TU -55000 to +55000: -055.000 to +055.000 mm LP-431U/431TU/421S9U/421S9TU/ 411U/411TU -27500 to +27500: -027.500 to +027.500 mm		
n + 7 to n + 8			Y-axis adjustment	LP-435U/435TU/425S9U/425S9TU -80000 to +80000: -080.000 to +080.000 mm		
n + 5 to n + 6			X-axis adjustment	LP-430U/430TU/420S9U/420S9TU/ 410U/410TU -55000 to +55000: -055.000 to +055.000 mm LP-431U/431TU/421S9U/421S9TU/ 411U/411TU -27500 to +27500: -027.500 to +027.500 mm		

Contents		F0	F1 (= \$u n)	F2		
Reading of text condition	Straight/ Proportional/ Monospace	1 - 8 (PLC1 - 8)	n	Station number: 0 (fixed)	3	
			n + 1	Command: 25H		
			n + 2	Condition number: 01 to 60		
			n + 3	Area number: 0 to F (HEX)		
			n + 4	Start line: 01 to 60		
			n + 5	End line: 01 to 60		
			n + 6	Standard character arrangement 0: Straight 1: Proportional 2: Monospace		
			n + 7	Text origin 0: Left end 1: Center 2: Right end		
			n + 8 to n + 9	Character height		LP-430U/430TU/420S9U/420S9TU/ 410U/410TU 200 to 110000: 000.200 to 110.000 mm LP-431U/431TU/421S9U/421S9TU/ 411U/411TU 200 to 55000: 000.200 to 055.000 mm
			n + 10 to n + 11	Character width		LP-435U/435TU/425S9U/425S9TU 200 to 160000: 000.200 to 160.000 mm
			n + 12 to n + 13	X position		LP-430U/430TU/420S9U/420S9TU/ 410U/410TU -55000 to +55000: -055.000 to +055.000 mm LP-431U/431TU/421S9U/421S9TU/ 411U/411TU -27500 to +27500: -027.500 to +027.500 mm
			n + 14 to n + 15	Y position		LP-435U/435TU/425S9U/425S9TU -80000 to +80000: -080.000 to +080.000 mm
			n + 16 to n + 17	Spaces between characters/ Entire width		LP-430U/430TU/420S9U/420S9TU/ 410U/410TU 0 to 110000: 000.000 to 110.000 mm LP-431U/431TU/421S9U/421S9TU/ 411U/411TU 0 to 55000: 000.000 to 055.000 mm
			n + 18 to n + 19	Spaces between lines		LP-435U/435TU/425S9U/425S9TU 000 to 160000: 000.000 to 160.000 mm
			n + 20	Tilting angle -18000 to +18000: -180.00° to +180.00°		
			n + 21	Font designation 1: Character font 1 2: Character font 2		
n + 22	Line width of bold character	LP-430U/430TU/435U/435TU/420S9U/ /420S9TU/425S9U/425S9TU/410U/ 410TU 0 to 6000: 0.000 to 6.000 mm LP-431U/431TU/421S9U/421S9TU/ 411U/411TU 0 to 4000: 0.000 to 4.000 mm				
n + 23	Laser power offset: 000 to 200%					
n + 24	Scan speed correction: 005 to 500%					

Contents		F0	F1 (= \$u n)		F2		
Reading of text condition	Arc-shaped printing	1 - 8 (PLC1 - 8)	n	Station number: 0 (fixed)		3	
			n + 1	Command: 25H			
			n + 2	Condition number: 01 to 60			
			n + 3	Area number: 0 to F (HEX)			
			n + 4	Start line: 01 to 60			
			n + 5	End line: 01 to 60			
			n + 6	Standard character arrangement 3: Printing out of the arc (clockwise) 4: Printing inside the arc (counterclockwise)			
			n + 7	Text origin 0: Left end 1: Center 2: Right end			
			n + 8 to n + 9	Character height	LP-430U/430TU/420S9U/420S9TU/ 410U/410TU 200 to 110000: 000.200 to 110.000 mm LP-431U/431TU/421S9U/421S9TU/ 411U/411TU 200 to 55000: 000.200 to 055.000 mm LP-435U/435TU/425S9U/425S9TU 200 to 160000: 000.200 to 160.000 mm		
			n + 10 to n + 11	Character width	LP-430U/430TU/420S9U/420S9TU/ 410U/410TU 200 to 110000: 000.200 to 110.000 mm LP-431U/431TU/421S9U/421S9TU/ 411U/411TU 200 to 55000: 000.200 to 055.000 mm LP-435U/435TU/425S9U/425S9TU 200 to 160000: 000.200 to 160.000 mm		
			n + 12 to n + 13	Center position X -300000 to +300000: -300.000 to +300.000 mm			
			n + 14 to n + 15	Center position Y -300000 to +300000: -300.000 to +300.000 mm			
			n + 16 to n + 17	Radius 0 to +300000: 000.000 to +300.000 mm			
			n + 18 to n + 19	Radius of spaces between lines	LP-430U/430TU/420S9U/420S9TU/ 410U/410TU 0 to 110000: 000.000 to 110.000 mm LP-431U/431TU/421S9U/421S9TU/ 411U/411TU 0 to 55000: 000.000 to 055.000 mm LP-435U/435TU/425S9U/425S9TU 000 to 160000: 000.000 to 160.000 mm		
			n + 20	Start angle -18000 to +18000: -180.00 to +180.00°			
			n + 21	Angle of spaces between characters -18000 to +18000: -180.00 to +180.00°			
			n + 22	Font designation 1: Character font 1 2: Character font 2			
			n + 23	Line width of bold character	LP-430U/430TU/435U/435TU/420S9U/ /420S9TU/425S9U/425S9TU/410U/ 410TU 0 to 6000: 0.000 to 6.000 mm LP-431U/431TU/421S9U/421S9TU/ 411U/411TU 0 to 4000: 0.000 to 4.000 mm		
			n + 24	Laser power offset: 000 to 200%			
			n + 25	Scan speed correction: 005 to 500%			

Contents		F0	F1 (= \$u n)	F2		
Writing of text condition	Straight/ Proportional/ Monospace	1 - 8 (PLC1 - 8)	n	Station number: 0 (fixed)	25	
			n + 1	Command: A5H		
			n + 2	Condition number: 01 to 60		
			n + 3	Area number: 0 to F (HEX)		
			n + 4	Start line: 01 to 60		
			n + 5	End line: 01 to 60		
			n + 6	Standard character arrangement 0: Straight 1: Proportional 2: Monospace		
			n + 7	Text origin 0: Left end 1: Center 2: Right end		
			n + 8 to n + 9	Character height		LP-430U/430TU/420S9U/420S9TU/ 410U/410TU 200 to 110000: 000.200 to 110.000 mm LP-431U/431TU/421S9U/421S9TU/ 411U/411TU 200 to 55000: 000.200 to 055.000 mm
			n + 10 to n + 11	Character width		LP-435U/435TU/425S9U/425S9TU 200 to 160000: 000.200 to 160.000 mm
			n + 12 to n + 13	X position		LP-430U/430TU/420S9U/420S9TU/ 410U/410TU -55000 to +55000: -055.000 to +055.000 mm LP-431U/431TU/421S9U/421S9TU/ 411U/411TU -27500 to +27500: -027.500 to +027.500 mm
			n + 14 to n + 15	Y position		LP-435U/435TU/425S9U/425S9TU -80000 to +80000: -080.000 to +080.000 mm
			n + 16 to n + 17	Spaces between characters/ Entire width		LP-430U/430TU/420S9U/420S9TU/ 410U/410TU 0 to 110000: 000.000 to 110.000 mm LP-431U/431TU/421S9U/421S9TU/ 411U/411TU 0 to 55000: 000.000 to 055.000 mm
			n + 18 to n + 19	Spaces between lines		LP-435U/435TU/425S9U/425S9TU 000 to 160000: 000.000 to 160.000 mm
			n + 20	Tilting angle -18000 to +18000: -180.00° to +180.00°		
			n + 21	Font designation 1: Character font 1 2: Character font 2		
n + 22	Line width of bold character	LP-430U/430TU/435U/435TU/420S9U/ /420S9TU/425S9U/425S9TU/410U/ 410TU 0 to 6000: 0.000 to 6.000 mm LP-431U/431TU/421S9U/421S9TU/ 411U/411TU 0 to 4000: 0.000 to 4.000 mm				
n + 23	Laser power offset: 000 to 200%					
n + 24	Scan speed correction: 005 to 500%					

Contents		F0	F1 (= \$u n)		F2		
Writing of text condition	Arc-shaped printing	1 - 8 (PLC1 - 8)	n	Station number: 0 (fixed)		26	
			n + 1	Command: A5H			
			n + 2	Condition number: 01 to 60			
			n + 3	Area number: 0 to F (HEX)			
			n + 4	Start line: 01 to 60			
			n + 5	End line: 01 to 60			
			n + 6	Standard character arrangement 3: Printing out of the arc (clockwise) 4: Printing inside the arc (counterclockwise)			
			n + 7	Text origin 0: Left end 1: Center 2: Right end			
			n + 8 to n + 9	Character height	LP-430U/430TU/420S9U/420S9TU/ 410U/410TU 200 to 110000: 000.200 to 110.000 mm LP-431U/431TU/421S9U/421S9TU/ 411U/411TU 200 to 55000: 000.200 to 055.000 mm LP-435U/435TU/425S9U/425S9TU 200 to 160000: 000.200 to 160.000 mm		
			n + 10 to n + 11	Character width	LP-430U/430TU/420S9U/420S9TU/ 410U/410TU 200 to 110000: 000.200 to 110.000 mm LP-431U/431TU/421S9U/421S9TU/ 411U/411TU 200 to 55000: 000.200 to 055.000 mm LP-435U/435TU/425S9U/425S9TU 200 to 160000: 000.200 to 160.000 mm		
			n + 12 to n + 13	Center position X -300000 to +300000: -300.000 to +300.000 mm			
			n + 14 to n + 15	Center position Y -300000 to +300000: -300.000 to +300.000 mm			
			n + 16 to n + 17	Radius 0 to +300000: 000.000 to +300.000 mm			
			n + 18 to n + 19	Radius of spaces between lines	LP-430U/430TU/420S9U/420S9TU/ 410U/410TU 0 to 110000: 000.000 to 110.000 mm LP-431U/431TU/421S9U/421S9TU/ 411U/411TU 0 to 55000: 000.000 to 055.000 mm LP-435U/435TU/425S9U/425S9TU 000 to 160000: 000.000 to 160.000 mm		
			n + 20	Start angle -18000 to +18000: -180.00 to +180.00°			
			n + 21	Angle of spaces between characters -18000 to +18000: -180.00 to +180.00°			
			n + 22	Font designation 1: Character font 1 2: Character font 2			
			n + 23	Line width of bold character	LP-430U/430TU/435U/435TU/420S9U/ /420S9TU/425S9U/425S9TU/410U/ 410TU 0 to 6000: 0.000 to 6.000 mm LP-431U/431TU/421S9U/421S9TU/ 411U/411TU 0 to 4000: 0.000 to 4.000 mm		
			n + 24	Laser power offset: 000 to 200%			
			n + 25	Scan speed correction: 005 to 500%			

Contents		F0	F1 (= \$u n)		F2	
Counter reset		1 - 8 (PLC1 - 8)	n	Station number: 0 (fixed)		10
			n + 1	Command: A6H		
			n + 2	Counter 0 0: Not reset 1: Reset		
			n + 3	Counter 1 0: Not reset 1: Reset		
			n + 4	Counter 2 0: Not reset 1: Reset		
			n + 5	Counter 3 0: Not reset 1: Reset		
			n + 6	Counter 4 0: Not reset 1: Reset		
			n + 7	Counter 5 0: Not reset 1: Reset		
			n + 8	Counter 6 0: Not reset 1: Reset		
			n + 9	Counter 7 0: Not reset 1: Reset		
Shutter		1 - 8 (PLC1 - 8)	n	Station number: 0 (fixed)		3
			n + 1	Command: A7H		
			n + 2	Shutter status 0: Shutter close 1: Shutter open		
Print trigger		1 - 8 (PLC1 - 8)	n	Station number: 0 (fixed)		3
			n + 1	Command: A8H		
			n + 2	Print command 0: Stop 1: Start		
One-point laser irradiation		1 - 8 (PLC1 - 8)	n	Station number: 0 (fixed)		3
			n + 1	Command: A9H		
			n + 2	0: Stop 1: Start 2: Suspend		
Step & repeat condition	Reading of condition	1 - 8 (PLC1 - 8)	n	Station number: 0 (fixed)		2
			n + 1	Command: 2AH		
			n + 2	Step & repeat 0: None 1: Provided		
			n + 3	Number of lines: 001 to 100		
			n + 4	Number of columns: 001 to 100		
			n + 5 to n + 6	Line step	LP-430U/430TU/420S9U/420S9TU/ 410U/410TU 0 to 110000: 000.000 to 110.000 mm LP-431U/431TU/421S9U/421S9TU/ 411U/411TU 0 to 55000: 000.000 to 055.000 mm LP-435U/435TU/425S9U/425S9TU 000 to 160000: 000.000 to 160.000 mm	
			n + 7 to n + 8	Column step		
			n + 9	Counter motion 0000H: Same for all steps 001xH: Unallocated number 002xH: Serial number 00x0H: From top left toward right 00x1H: From top left toward bottom 00x2H: From top right toward left 00x3H: From top right toward bottom		

Contents		F0	F1 (= \$u n)		F2	
Step & repeat condition	Writing of condition	1 - 8 (PLC1 - 8)	n	Station number: 0 (fixed)		10
			n + 1	Command: AAH		
			n + 2	Step & repeat 0: None 1: Provided		
			n + 3	Number of lines: 001 to 100		
			n + 4	Number of columns: 001 to 100		
			n + 5 to n + 6	Line step	LP-430U/430TU/420S9U/420S9TU/ 410U/410TU 0 to 110000: 000.000 to 110.000 mm LP-431U/431TU/421S9U/421S9TU/ 411U/411TU 0 to 55000: 000.000 to 055.000 mm LP-435U/435TU/425S9U/425S9TU 000 to 160000: 000.000 to 160.000 mm	
			n + 7 to n + 8	Column step	LP-430U/430TU/420S9U/420S9TU/ 410U/410TU 0 to 110000: 000.000 to 110.000 mm LP-431U/431TU/421S9U/421S9TU/ 411U/411TU 0 to 55000: 000.000 to 055.000 mm LP-435U/435TU/425S9U/425S9TU 000 to 160000: 000.000 to 160.000 mm	
n + 9	Counter motion 0000H: Same for all steps 001xH: Unallocated number 002xH: Serial number 00x0H: From top left toward right 00x1H: From top left toward bottom 00x2H: From top right toward left 00x3H: From top right toward bottom					
Text condition (abbreviated form)	Reading of text condition (abbreviated form)	1 - 8 (PLC1 - 8)	n	Station number: 0 (fixed)		3
			n + 1	Command: 2BH		
			n + 2	Condition number (01 to 60)		
			n + 3 to n + 4	X position	LP-430U/430TU/420S9U/420S9TU/ 410U/410TU -55000 to +55000: -055.000 to +055.000 mm LP-431U/431TU/421S9U/421S9TU/ 411U/411TU -27500 to +27500: -027.500 to +027.500 mm LP-435U/435TU/425S9U/425S9TU -80000 to +80000: -080.000 to +080.000 mm	
	n + 5 to n + 6	Y position	LP-430U/430TU/420S9U/420S9TU/ 410U/410TU -55000 to +55000: -055.000 to +055.000 mm LP-431U/431TU/421S9U/421S9TU/ 411U/411TU -27500 to +27500: -027.500 to +027.500 mm LP-435U/435TU/425S9U/425S9TU -80000 to +80000: -080.000 to +080.000 mm			
	n + 6 to n + 7	Laser power offset: 000 to 200%				
	n + 6 to n + 7	Laser power offset: 000 to 200%				
Text condition (abbreviated form)	Writing of text condition (abbreviated form)	1 - 8 (PLC1 - 8)	n	Station number: 0 (fixed)		8
			n + 1	Command: ABH		
			n + 2	Condition number (01 to 60)		
			n + 3 to n + 4	X position	LP-430U/430TU/420S9U/420S9TU/ 410U/410TU -55000 to +55000: -055.000 to +055.000 mm LP-431U/431TU/421S9U/421S9TU/ 411U/411TU -27500 to +27500: -027.500 to +027.500 mm LP-435U/435TU/425S9U/425S9TU -80000 to +80000: -080.000 to +080.000 mm	
			n + 5 to n + 6	Y position	LP-430U/430TU/420S9U/420S9TU/ 410U/410TU -55000 to +55000: -055.000 to +055.000 mm LP-431U/431TU/421S9U/421S9TU/ 411U/411TU -27500 to +27500: -027.500 to +027.500 mm LP-435U/435TU/425S9U/425S9TU -80000 to +80000: -080.000 to +080.000 mm	
			n + 6 to n + 7	Laser power offset: 000 to 200%		
			n + 6 to n + 7	Laser power offset: 000 to 200%		

Contents		F0	F1 (= \$u n)		F2				
Reading of barcode print condition	QR code	1 to 8 (PLC1 to 8)	n	Station number: 0 (fixed)		3			
			n+1	Command: 2CH					
			n+2	Barcode number: 0 to 7					
			n+3	Area number: 0 to FH					
			n+4	Type 10: Model 1 11: Model 2 12: Micro QR					
			n+5	Version Model 1: 0 to 14 Model 2: 0 to 22 Micro QR: 0 to 4					
			n+6	Data input mode 0: Numerals 1: Alphanumerics 2: Binary 3: Kanji characters					
			n+7	Error correction level 1: Standard 2: High reliability 3: Ultra-high reliability					
			n+8 to n+9	X position	LP-430U/430TU/420S9U/420S9TU/ 410U/410TU -55000 to +55000: -055.000 to +055.000 mm LP-431U/431TU/421S9U/421S9TU/ 411U/411TU				
			n+10 to n+11	Y position	-27500 to +27500: -027.500 to +027.500 mm LP-435U/435TU/425S9U/425S9TU -80000 to +80000: -080.000 to +080.000 mm				
			n+12 to n+13	Rotation angle -18000 to +18000: -180.00 to +180.00 deg					
			n+14	Module pitch: vertical 0050 to 1000: 0.050 to 1.000 mm					
			n+15	Module pitch: horizontal 0050 to 1000: 0.050 to 1.000 mm					
			Data matrix code (ECC200)	1 to 8 (PLC1 to 8)	n		Station number: 0 (fixed)		3
					n+1		Command: 2CH		
	n+2	Barcode number: 0 to 7							
	n+3	Area number: 0 to FH							
	n+4	Type 20: Data matrix							
	n+5	Data input mode 0: 1-byte 1: Kanji characters							
	n+6	Number of rows							
	n+7	Number of columns							
	n+8 to n+9	X position			LP-430U/430TU/420S9U/420S9TU/ 410U/410TU -55000 to +55000: -055.000 to +055.000 mm LP-431U/431TU/421S9U/421S9TU/ 411U/411TU				
	n+10 to n+11	Y position			-27500 to +27500: -027.500 to +027.500 mm LP-435U/435TU/425S9U/425S9TU -80000 to +80000: -080.000 to +080.000 mm				
	n+12 to n+13	Rotation angle -18000 to +18000: -180.00 to +180.00 deg							
	n+14	Module pitch: vertical 0050 to 1000: 0.050 to 1.000 mm							
	n+15	Module pitch: horizontal 0050 to 1000: 0.050 to 1.000 mm							

Contents		F0	F1 (= \$u n)		F2			
Reading of barcode print condition	CODE39 ITF NW-7	1 to 8 (PLC1 to 8)	n	Station number: 0 (fixed)	3			
			n+1	Command: 2CH				
			n+2	Barcode number: 0 to 7				
			n+3	Area number: 0 to FH				
			n+4	Type 00: CODE39 01: ITF 03: NW-7				
			n+5	Inversion 0: Invalid 1: Valid				
			n+6	Check character CODE39, ITF 0: No 1: Yes NW-7 A to D: Without check character a to d: With check character				
			n+7 to n+8	Height		LP-430U/430TU/420S9U/420S9TU/ 410U/410TU 001000 to 110000: 001.000 to 110.000 mm LP-431U/431TU/421S9U/421S9TU/ 411U/411TU 001000 to 055000: 001.000 to 055.000 mm LP-435U/435TU/425S9U/425S9TU 001000 to 160000: 001.000 to 160.000 mm		
			n+9	Narrow element width 0050 to 1000: 0.050 to 1.000 mm				
			n+10 to n+11	X position		LP-430U/430TU/420S9U/420S9TU/ 410U/410TU -55000 to +55000: -055.000 to +055.000 mm LP-431U/431TU/421S9U/421S9TU/ 411U/411TU -27500 to +27500: -027.500 to +027.500 mm LP-435U/435TU/425S9U/425S9TU -80000 to +80000: -080.000 to +080.000 mm		
			n+12 to n+13	Y position		LP-430U/430TU/420S9U/420S9TU/ 410U/410TU -55000 to +55000: -055.000 to +055.000 mm LP-431U/431TU/421S9U/421S9TU/ 411U/411TU -27500 to +27500: -027.500 to +027.500 mm LP-435U/435TU/425S9U/425S9TU -80000 to +80000: -080.000 to +080.000 mm		
			n+14 to n+15	Tilting angle -18000 to +18000: -180.00 to +180.00 deg				
			n+16	Ratio quiet zone/narrow element 000 to 200: 00.0 to 20.0				
			n+17	Ratio wide element width/narrow element width 18 to 34: 1.8 to 3.4				
			n+18	Laser power correction: 0 to 200%				
			n+19	Scan speed correction: 5 to 500%				
			CODE128 JAN	1 to 8 (PLC1 to 8)		n	Station number: 0 (fixed)	3
						n+1	Command: 2CH	
						n+2	Barcode number: 0 to 7	
	n+3	Area number: 0 to FH						
n+4	Type 02: CODE128 04: JAN/UPC 08: JAN/UPC with human-readable string 09: CODE128 with human-readable string							
n+5	Inversion 0: Invalid 1: Valid							
n+6	Check character 0: No 1: Yes							

Contents		F0	F1 (= \$u n)		F2	
Reading of barcode print condition	CODE128 JAN	1 to 8 (PLC1 to 8)	n+7 to n+8	Height	LP-430U/430TU/420S9U/420S9TU/ 410U/410TU 001000 to 110000: 001.000 to 110.000 mm LP-431U/431TU/421S9U/421S9TU/ 411U/411TU 001000 to 055000: 001.000 to 055.000 mm LP-435U/435TU/425S9U/425S9TU 001000 to 160000: 001.000 to 160.000 mm	3
			n+9	Narrow element width 0050 to 1000: 0.050 to 1.000 mm		
			n+10 to n+11	X position	LP-430U/430TU/420S9U/420S9TU/ 410U/410TU -55000 to +55000: -055.000 to +055.000 mm LP-431U/431TU/421S9U/421S9TU/ 411U/411TU -27500 to +27500: -027.500 to +027.500 mm LP-435U/435TU/425S9U/425S9TU -80000 to +80000: -080.000 to +080.000 mm	
			n+12 to n+13	Y position		
			n+14 to n+15	Tilting angle -18000 to +18000: -180.00 to +180.00 deg		
			n+16	Ratio quiet zone/narrow element 000 to 200: 00.0 to 20.0		
			n+17	Ratio double width/narrow element width 14 to 26: 1.4 to 2.6		
			n+18	Ratio triple width/narrow element width 21 to 39: 2.1 to 3.9		
			n+19	Ratio quadruple width/narrow element width 28 to 52: 2.8 to 5.2		
			n+20	Laser power correction: 0 to 200%		
			n+21	Scan speed correction: 5 to 500%		
			RSS-14 Standard & Truncated RSS Limited RSS Expanded	1 to 8 (PLC1 to 8)	n	
	n+1	Command: 2CH				
	n+2	Barcode number: 0 to 7				
	n+3	Area number: 0 to FH				
	n+4	Type 30: RSS-14 Standard & Truncated 33: RSS Limited 34: RSS Expanded 40: RSS-14 Standard & Truncated CC-A 43: RSS Limited CC-A 44: RSS Expanded CC-A 50: RSS-14 Standard & Truncated CC-B 53: RSS Limited CC-B 54: RSS Expanded CC-B				
	n+5	Human-readable string 0: Without human-readable string 2: With human-readable string				
	n+6	Inversion 0: Invalid 1: Valid 2: Valid (with guard pattern)				
	n+7 to n+8	Height			LP-430U/430TU/420S9U/420S9TU/ 410U/410TU 001000 to 110000: 001.000 to 110.000 mm LP-431U/431TU/421S9U/421S9TU/ 411U/411TU 001000 to 055000: 001.000 to 055.000 mm LP-435U/435TU/425S9U/425S9TU 001000 to 160000: 001.000 to 160.000 mm	
	n+9	Standard module width 0050 to 1000: 0.050 to 1.000 mm				

Contents		F0	F1 (= \$u n)		F2	
Reading of barcode print condition	RSS-14 Standard & Truncated RSS Limited RSS Expanded	1 to 8 (PLC1 to 8)	n+10 to n+11	X position	LP-430U/430TU/420S9U/420S9TU/410U/410TU -55000 to +55000: -055.000 to +055.000 mm LP-431U/431TU/421S9U/421S9TU/411U/411TU -27500 to +27500: -027.500 to +027.500 mm LP-435U/435TU/425S9U/425S9TU -80000 to +80000: -080.000 to +080.000 mm	3
			n+12 to n+13	Y position		
			n+14 to n+15	Tilting angle -18000 to +18000: -180.00 to +180.00 deg		
			n+16	Laser power correction: 0 to 200%		
			n+17	Scan speed correction: 5 to 500%		
			n	Station number: 0 (fixed)		
			n+1	Command: 2CH		3
			n+2	Barcode number: 0 to 7		
			n+3	Area number: 0 to FH		
			n+4	Type 31: RSS-14 Stacked 32: RSS-14 Stacked Omnidirectional 41: RSS-14 Stacked CC-A 42: RSS-14 Stacked Omnidirectional CC-A 51: RSS-14 Stacked CC-B 52: RSS-14 Stacked Omnidirectional CC-B		
			n+5	Human-readable string 0: Without human-readable string 2: With human-readable string		
			n+6	Inversion 0: Invalid 1: Valid 2: Valid (with guard pattern)		
			n+7 to n+8	Barcode 1-stack height	LP-430U/430TU/420S9U/420S9TU/410U/410TU 001000 to 110000: 001.000 to 110.000 mm LP-431U/431TU/421S9U/421S9TU/411U/411TU 001000 to 055000: 001.000 to 055.000 mm LP-435U/435TU/425S9U/425S9TU 001000 to 160000: 001.000 to 160.000 mm	
			n+9	Separator height (W) ratio 000 to 100: 00.0 to 10.0 mm		
			n+10	Standard module width 0050 to 1000: 0.050 to 1.000 mm		
			n+11 to n+12	X position	LP-430U/430TU/420S9U/420S9TU/410U/410TU -55000 to +55000: -055.000 to +055.000 mm LP-431U/431TU/421S9U/421S9TU/411U/411TU -27500 to +27500: -027.500 to +027.500 mm LP-435U/435TU/425S9U/425S9TU -80000 to +80000: -080.000 to +080.000 mm	
			n+13 to n+14	Y position		
			n+15 to n+16	Tilting angle -18000 to +18000: -180.00 to +180.00 deg		
		n+17	Laser power correction: 0 to 200%			
		n+18	Scan speed correction: 5 to 500%			

Contents		F0	F1 (= \$u n)		F2	
Reading of barcode print condition	RSS-14 Expanded Stacked	1 to 8 (PLC1 to 8)	n	Station number: 0 (fixed)		3
			n+1	Command: 2CH		
			n+2	Barcode number: 0 to 7		
			n+3	Area number: 0 to FH		
			n+4	Type 35: RSS Expanded Stacked 45: RSS Expanded Stacked CC-A 55: RSS Expanded Stacked CC-B		
			n+5	Human-readable string 0: Without human-readable string 2: With human-readable string		
			n+6	Inversion 0: Invalid 1: Valid 2: Valid (with guard pattern)		
			n+7 to n+8	Barcode 1-stack height	LP-430U/430TU/420S9U/420S9TU/410U/410TU 001000 to 110000: 001.000 to 110.000 mm	
					LP-431U/431TU/421S9U/421S9TU/411U/411TU 001000 to 055000: 001.000 to 055.000 mm LP-435U/435TU/425S9U/425S9TU 001000 to 160000: 001.000 to 160.000 mm	
			n+9	Separator height (W) ratio 000 to 100: 00.0 to 10.0 mm		
			n+10	Number of horizontal symbol characters: 2 to 20 (even)		
			n+11	Standard module width 0050 to 1000: 0.050 to 1.000 mm		
			n+12 to n+13	X position	LP-430U/430TU/420S9U/420S9TU/410U/410TU -55000 to +55000: -055.000 to +055.000 mm	
	LP-431U/431TU/421S9U/421S9TU/411U/411TU -27500 to +27500: -027.500 to +027.500 mm					
	n+14 to n+15	Y position	LP-435U/435TU/425S9U/425S9TU -80000 to +80000: -080.000 to +080.000 mm			
	n+16 to n+17	Tilting angle -18000 to +18000: -180.00 to +180.00 deg				
	n+18	Laser power correction: 0 to 200%				
	n+19	Scan speed correction: 5 to 500%				
	Composite	1 to 8 (PLC1 to 8)	n	Station number: 0 (fixed)		3
n+1			Command: 2CH			
n+2			Barcode number: 0 to 7			
n+3			Area number: 0 to FH			
n+4			Type CC-A composite 46: JAN/UPC 47: UCC/EAN128 48: JAN/UPC with 1D human-readable string 49: UCC/EAN128 with 1D human-readable string CC-B composite 56: JAN/UPC 57: UCC/EAN128 58: JAN/UPC with 1D human-readable string 59: UCC/EAN128 with 1D human-readable string CC-C composite 67: UCC/EAN128 69: UCC/EAN128 with 1D human-readable string			
			Human-readable string 0: Without human-readable string 2: With human-readable string			
			Inversion 0: Invalid 1: Valid			

Contents		F0	F1 (= \$u n)		F2	
Reading of barcode print condition	Composite	1 to 8 (PLC1 to 8)	n+7 to n+8	Barcode 1-stack height	LP-430U/430TU/420S9U/420S9TU/ 410U/410TU 001000 to 110000: 001.000 to 110.000 mm LP-431U/431TU/421S9U/421S9TU/ 411U/411TU 001000 to 055000: 001.000 to 055.000 mm LP-435U/435TU/425S9U/425S9TU 001000 to 160000: 001.000 to 160.000 mm	3
			n+9	Narrow element width 0050 to 1000: 0.050 to 1.000 mm		
			n+10 to n+11	X position	LP-430U/430TU/420S9U/420S9TU/ 410U/410TU -55000 to +55000: -055.000 to +055.000 mm LP-431U/431TU/421S9U/421S9TU/ 411U/411TU -27500 to +27500: -027.500 to +027.500 mm LP-435U/435TU/425S9U/425S9TU -80000 to +80000: -080.000 to +080.000 mm	
			n+12 to n+13	Y position		
			n+14 to n+15	Tilting angle -18000 to +18000: -180.00 to +180.00 deg		
			n+16	Ratio quiet zone/narrow element 000 to 200: 00.0 to 20.0		
			n+17	Laser power correction: 0 to 200%		
			n+18	Scan speed correction: 5 to 500%		
			Writing of barcode print condition	QR code	1 to 8 (PLC1 to 8)	
n+1	Command: ACH					
n+2	Barcode number: 0 to 7					
n+3	Area number: 0 to FH					
n+4	Type 10: Model 1 11: Model 2 12: Micro QR					
n+5	Version Model 1: 0 to 14 Model 2: 0 to 22 Micro QR: 0 to 4					
n+6	Data input mode 0: Numerals 1: Alphanumerics 2: Binary 3: Kanji characters					
n+7	Error correction level 0: High density 1: Standard 2: High reliability 3: Ultra-high reliability					
n+8 to n+9	X position	LP-430U/430TU/420S9U/420S9TU/ 410U/410TU -55000 to +55000: -055.000 to +055.000 mm LP-431U/431TU/421S9U/421S9TU/ 411U/411TU -27500 to +27500: -027.500 to +027.500 mm LP-435U/435TU/425S9U/425S9TU -80000 to +80000: -080.000 to +080.000 mm				
n+10 to n+11	Y position					
n+12 to n+13	Rotation angle -18000 to +18000: -180.00 to +180.00 deg					
n+14	Module pitch: vertical 0050 to 1000: 0.050 to 1.000 mm					
n+15	Module pitch: horizontal 0050 to 1000: 0.050 to 1.000 mm					

Contents		F0	F1 (= \$u n)		F2	
Writing of barcode print condition	Data matrix code (ECC200)	1 to 8 (PLC1 to 8)	n	Station number: 0 (fixed)		16
			n+1	Command: ACH		
			n+2	Barcode number: 0 to 7		
			n+3	Area number: 0 to FH		
			n+4	Type 20: Data matrix		
			n+5	Data input mode 0: 1-byte 1: Kanji characters		
			n+6	Number of rows		
			n+7	Number of columns		
			n+8 to n+9	X position	LP-430U/430TU/420S9U/420S9TU/ 410U/410TU -55000 to +55000: -055.000 to +055.000 mm LP-431U/431TU/421S9U/421S9TU/ 411U/411TU -27500 to +27500: -027.500 to +027.500 mm LP-435U/435TU/425S9U/425S9TU -80000 to +80000: -080.000 to +080.000 mm	
			n+10 to n+11	Y position		
	n+12 to n+13	Rotation angle -18000 to +18000: -180.00 to +180.00 deg				
	n+14	Module pitch: vertical 0050 to 1000: 0.050 to 1.000 mm				
	n+15	Module pitch: horizontal 0050 to 1000: 0.050 to 1.000 mm				
	CODE39 ITF NW-7	1 to 8 (PLC1 to 8)	n	Station number: 0 (fixed)		20
			n+1	Command: ACH		
			n+2	Barcode number: 0 to 7		
			n+3	Area number: 0 to FH		
			n+4	Type 00: CODE39 01: ITF 03: NW-7		
			n+5	Inversion 0: Invalid 1: Valid		
			n+6	Check character CODE39, ITF 0: No 1: Yes NW-7 A to D: Without check character a to d: With check character		
n+7 to n+8			Height	LP-430U/430TU/420S9U/420S9TU/ 410U/410TU 001000 to 110000: 001.000 to 110.000 mm LP-431U/431TU/421S9U/421S9TU/ 411U/411TU 001000 to 055000: 001.000 to 055.000 mm LP-435U/435TU/425S9U/425S9TU 001000 to 160000: 001.000 to 160.000 mm		
n+9			Narrow element width 0050 to 1000: 0.050 to 1.000 mm			
n+10 to n+11			X position	LP-430U/430TU/420S9U/420S9TU/ 410U/410TU -55000 to +55000: -055.000 to +055.000 mm LP-431U/431TU/421S9U/421S9TU/ 411U/411TU -27500 to +27500: -027.500 to +027.500 mm LP-435U/435TU/425S9U/425S9TU -80000 to +80000: -080.000 to +080.000 mm		
n+12 to n+13	Y position					

Contents		F0	F1 (= \$u n)		F2		
Writing of barcode print condition	CODE39 ITF NW-7	1 to 8 (PLC1 to 8)	n+14 to n+15	Tilting angle -18000 to +18000: -180.00 to +180.00 deg		20	
			n+16	Ratio quiet zone/narrow element 000 to 200: 00.0 to 20.0			
			n+17	Ratio wide element width/narrow element width 18 to 34: 1.8 to 3.4			
			n+18	Laser power correction: 0 to 200%			
			n+19	Scan speed correction: 5 to 500%			
	CODE128 JAN	1 to 8 (PLC1 to 8)	n	Station number: 0 (fixed)		22	
			n+1	Command: ACH			
			n+2	Barcode number: 0 to 7			
			n+3	Area number: 0 to FH			
			n+4	Type 02: CODE128 04: JAN 08: JAN/UPC with human-readable string 09: CODE128 with human-readable string			
			n+5	Inversion 0: Invalid 1: Valid			
			n+6	Check character 0: No 1: Yes			
			n+7 to n+8	Height	LP-430U/430TU/420S9U/420S9TU/ 410U/410TU 001000 to 110000: 001.000 to 110.000 mm LP-431U/431TU/421S9U/421S9TU/ 411U/411TU 001000 to 055000: 001.000 to 055.000 mm LP-435U/435TU/425S9U/425S9TU 001000 to 160000: 001.000 to 160.000 mm		
			n+9	Narrow element width 0050 to 1000: 0.050 to 1.000 mm			
			n+10 to n+11	X position	LP-430U/430TU/420S9U/420S9TU/ 410U/410TU -55000 to +55000: -055.000 to +055.000 mm LP-431U/431TU/421S9U/421S9TU/ 411U/411TU -27500 to +27500: -027.500 to +027.500 mm LP-435U/435TU/425S9U/425S9TU -80000 to +80000: -080.000 to +080.000 mm		
			n+12 to n+13	Y position			
			n+14 to n+15	Tilting angle -18000 to +18000: -180.00 to +180.00 deg			
			n+16	Ratio quiet zone/narrow element 000 to 200: 00.0 to 20.0			
			n+17	Ratio double width/narrow element width 14 to 26: 1.4 to 2.6			
			n+18	Ratio triple width/narrow element width 21 to 39: 2.1 to 3.9			
			n+19	Ratio quadruple width/narrow element width 28 to 52: 2.8 to 5.2			
n+20	Laser power correction: 0 to 200%						
n+21	Scan speed correction: 5 to 500%						

Contents		F0	F1 (= \$u n)		F2	
Writing of barcode print condition	RSS-14 Standard & Truncated RSS Limited RSS Expanded	1 to 8 (PLC1 to 8)	n	Station number: 0 (fixed)		18
			n+1	Command: ACH		
			n+2	Barcode number: 0 to 7		
			n+3	Area number: 0 to FH		
			n+4	Type 30: RSS-14 Standard & Truncated 33: RSS Limited 34: RSS Expanded 40: RSS-14 Standard & Truncated CC-A 43: RSS Limited CC-A 44: RSS Expanded CC-A 50: RSS-14 Standard & Truncated CC-B 53: RSS Limited CC-B 54: RSS Expanded CC-B		
			n+5	Human-readable string 0: Without human-readable string 2: With human-readable string		
			n+6	Inversion 0: Invalid 1: Valid 2: Valid (with guard pattern)		
			n+7 to n+8	Height	LP-430U/430TU/420S9U/420S9TU/ 410U/410TU 001000 to 110000: 001.000 to 110.000 mm LP-431U/431TU/421S9U/421S9TU/ 411U/411TU 001000 to 055000: 001.000 to 055.000 mm LP-435U/435TU/425S9U/425S9TU 001000 to 160000: 001.000 to 160.000 mm	
			n+9	Standard module width 0050 to 1000: 0.050 to 1.000 mm		
			n+10 to n+11	X position	LP-430U/430TU/420S9U/420S9TU/ 410U/410TU -55000 to +55000: -055.000 to +055.000 mm LP-431U/431TU/421S9U/421S9TU/ 411U/411TU	
	n+12 to n+13	Y position	-27500 to +27500: -027.500 to +027.500 mm LP-435U/435TU/425S9U/425S9TU -80000 to +80000: -080.000 to +080.000 mm			
	n+14 to n+15	Tilting angle -18000 to +18000: -180.00 to +180.00 deg				
	n+16	Laser power correction: 0 to 200%				
	n+17	Scan speed correction: 5 to 500%				
	RSS-14 Stacked RSS-14 Stacked Omnidirectional	1 to 8 (PLC1 to 8)	n	Station number: 0 (fixed)		19
			n+1	Command: ACH		
			n+2	Barcode number: 0 to 7		
			n+3	Area number: 0 to FH		
			n+4	Type 31: RSS-14 Stacked 32: RSS-14 Stacked Omnidirectional 41: RSS-14 Stacked CC-A 42: RSS-14 Stacked Omnidirectional CC-A 51: RSS-14 Stacked CC-B 52: RSS-14 Stacked Omnidirectional CC-B		
			n+5	Human-readable string 0: Without human-readable string 2: With human-readable string		
n+6	Inversion 0: Invalid 1: Valid 2: Valid (with guard pattern)					

Contents		F0	F1 (= \$u n)			F2	
Writing of barcode print condition	RSS-14 Stacked RSS-14 Stacked Omnidirectional		n+7 to n+8	Barcode 1-stack height	LP-430U/430TU/420S9U/420S9TU/ 410U/410TU 001000 to 110000: 001.000 to 110.000 mm LP-431U/431TU/421S9U/421S9TU/ 411U/411TU 001000 to 055000: 001.000 to 055.000 mm LP-435U/435TU/425S9U/425S9TU 001000 to 160000: 001.000 to 160.000 mm	19	
			n+9	Separator height (W) ratio 000 to 100: 00.0 to 10.0 mm			
			n+10	Standard module width 0050 to 1000: 0.050 to 1.000 mm			
			n+11 to n+12	X position	LP-430U/430TU/420S9U/420S9TU/ 410U/410TU -55000 to +55000: -055.000 to +055.000 mm LP-431U/431TU/421S9U/421S9TU/ 411U/411TU -27500 to +27500: -027.500 to +027.500 mm LP-435U/435TU/425S9U/425S9TU -80000 to +80000: -080.000 to +080.000 mm		
			n+13 to n+14	Y position			
			n+15 to n+16	Tilting angle -18000 to +18000: -180.00 to +180.00 deg			
			n+17	Laser power correction: 0 to 200%			
			n+18	Scan speed correction: 5 to 500%			
	RSS-14 Expanded Stacked	1 to 8 (PLC1 to 8)	n	Station number: 0 (fixed)			20
			n+1	Command: ACH			
			n+2	Barcode number: 0 to 7			
			n+3	Area number: 0 to FH			
			n+4	Type 35: RSS Expanded Stacked 45: RSS Expanded Stacked CC-A 55: RSS Expanded Stacked CC-B			
			n+5	Human-readable string 0: Without human-readable string 2: With human-readable string			
			n+6	Inversion 0: Invalid 1: Valid 2: Valid (with guard pattern)			
			n+7 to n+8	Barcode 1-stack height	LP-430U/430TU/420S9U/420S9TU/ 410U/410TU 001000 to 110000: 001.000 to 110.000 mm LP-431U/431TU/421S9U/421S9TU/ 411U/411TU 001000 to 055000: 001.000 to 055.000 mm LP-435U/435TU/425S9U/425S9TU 001000 to 160000: 001.000 to 160.000 mm		
			n+9	Separator height (W) ratio 000 to 100: 00.0 to 10.0 mm			
			n+10	Number of horizontal symbol characters: 2 to 20 (even)			
n+11	Standard module width 0050 to 1000: 0.050 to 1.000 mm						
n+12 to n+13	X position	LP-430U/430TU/420S9U/420S9TU/ 410U/410TU -55000 to +55000: -055.000 to +055.000 mm LP-431U/431TU/421S9U/421S9TU/ 411U/411TU -27500 to +27500: -027.500 to +027.500 mm LP-435U/435TU/425S9U/425S9TU -80000 to +80000: -080.000 to +080.000 mm					
n+14 to n+15	Y position						

Contents		F0	F1 (= \$u n)		F2		
Writing of barcode print condition	RSS-14 Expanded Stacked	1 to 8 (PLC1 to 8)	n+16 to n+17	Tilting angle -18000 to +18000: -180.00 to +180.00 deg		20	
			n+18	Laser power correction: 0 to 200%			
			n+19	Scan speed correction: 5 to 500%			
	Composite	1 to 8 (PLC1 to 8)	n	Station number: 0 (fixed)		19	
			n+1	Command: ACH			
			n+2	Barcode number: 0 to 7			
			n+3	Area number: 0 to FH			
			n+4	Type CC-A composite 46: JAN/UPC 47: UCC/EAN128 48: JAN/UPC with 1D human-readable string 49: UCC/EAN128 with 1D human-readable string CC-B composite 56: JAN/UPC 57: UCC/EAN128 58: JAN/UPC with 1D human-readable string 59: UCC/EAN128 with 1D human-readable string CC-C composite 67: UCC/EAN128 69: UCC/EAN128 with 1D human-readable string			
			n+5	Human-readable string 0: Without human-readable string 2: With human-readable string			
			n+6	Inversion 0: Invalid 1: Valid			
			n+7 to n+8	Barcode 1-stack height	LP-430U/430TU/420S9U/420S9TU/410U/410TU 001000 to 110000: 001.000 to 110.000 mm LP-431U/431TU/421S9U/421S9TU/411U/411TU 001000 to 055000: 001.000 to 055.000 mm LP-435U/435TU/425S9U/425S9TU 001000 to 160000: 001.000 to 160.000 mm		
			n+9	Narrow element width 0050 to 1000: 0.050 to 1.000 mm			
			n+10 to n+11	X position	LP-430U/430TU/420S9U/420S9TU/410U/410TU -55000 to +55000: -055.000 to +055.000 mm LP-431U/431TU/421S9U/421S9TU/411U/411TU -27500 to +27500: -027.500 to +027.500 mm LP-435U/435TU/425S9U/425S9TU -80000 to +80000: -080.000 to +080.000 mm		
			n+12 to n+13	Y position	LP-430U/430TU/420S9U/420S9TU/410U/410TU -55000 to +55000: -055.000 to +055.000 mm LP-431U/431TU/421S9U/421S9TU/411U/411TU -27500 to +27500: -027.500 to +027.500 mm LP-435U/435TU/425S9U/425S9TU -80000 to +80000: -080.000 to +080.000 mm		
			n+14 to n+15	Tilting angle -18000 to +18000: -180.00 to +180.00 deg			
			n+16	Ratio quiet zone/narrow element 000 to 200: 00.0 to 20.0			
			n+17	Laser power correction: 0 to 200%			
			n+18	Scan speed correction: 5 to 500%			
Barcode print data (2-byte characters)	Reading of barcode print data	1 to 8 (PLC1 to 8)	n	Station number: 0 (fixed)		4	
			n+1	Command: 2DH			
			n+2	Barcode number: 0 to 7			
			n+3	Set row number (2-D code): 1 to 9			
	Writing of barcode print data	1 to 8 (PLC1 to 8)	n	Station number: 0 (fixed)		4 + print data word count (30 words maximum)	
			n+1	Command: ADH			
			n+2	Barcode number: 0 to 7			
n+3	Set row number (2-D code): 1 to 9						
n+4 to n+33	Print data						

Contents		F0	F1 (= \$u n)		F2	
2-D code pattern	Reading of 2-D code pattern	1 to 8 (PLC1 to 8)	n	Station number: 0 (fixed)		4
			n+1	Command: 2EH		
			n+2	Barcode number: 0 to 7		
			n+3	Pattern number For QR code 0: Quite zone/margin 1: Black module 2: White module 3: Alignment 4: Finder For data matrix code 0: Quite zone/margin 1: Mark module 2: Space module		
			n+4	Character code (DEC) 0000, 2230 to 2239, 8121 to 8152		
			n+5	Laser power correction: 0 to 200%		
			n+6	Scan speed correction: 5 to 500%		
	Writing of 2-D code pattern	1 to 8 (PLC1 to 8)	n	Station number: 0 (fixed)		7
			n+1	Command: AEH		
			n+2	Barcode number: 0 to 7		
			n+3	Pattern number For QR code 0: Quite zone/margin 1: Black module 2: White module 3: Alignment 4: Finder For data matrix code 0: Quite zone/margin 1: Mark module 2: Space module		
			n+4	Character code (DEC) 0000, 2230 to 2239, 8121 to 8152		
			n+5	Laser power correction: 0 to 200%		
			n+6	Scan speed correction: 5 to 500%		
Serial data input		1 to 8 (PLC1 to 8)	n	Station number: 0 (fixed)		3 + data word count (128 words maximum)
			n+1	Command: AFH		
			n+2	Serial data number: 0 to 15		
			n+3 to n+130	Data		
Processing condition setting	Reading of processing condition	1 to 8 (PLC1 to 8)	n	Station number: 0 (fixed)		3
			n+1	Command: 30H		
			n+2	Processing condition number: 0 to 7		
			n+3	Area number: 0 to FH		
			n+4 to n+5	X offset	LP-430U/430TU/420S9U/420S9TU/ 410U/410TU -55000 to +55000: -055.000 to +055.000 mm LP-431U/431TU/421S9U/421S9TU/ 411U/411TU -27500 to +27500: -027.500 to +027.500 mm	
			n+6 to n+7	Y offset	LP-435U/435TU/425S9U/425S9TU -80000 to +80000: -080.000 to +080.000 mm	
			n+8	Rotation angle -18000 to +18000: -180.00 to +180.00 deg		
			n+9	Laser power correction: 0 to 200%		
			n+10	Scan speed correction: 5 to 500%		

Contents		F0	F1 (= \$u n)		F2					
Processing condition setting	Writing of processing condition	1 to 8 (PLC1 to 8)	n	Station number: 0 (fixed)		12				
			n+1	Command: B0H						
			n+2	Processing condition number: 0 to 7						
			n+3	Area number: 0 to FH						
			n+4 to n+5	X offset	LP-430U/430TU/420S9U/420S9TU/ 410U/410TU -55000 to +55000: -055.000 to +055.000 mm LP-431U/431TU/421S9U/421S9TU/ 411U/411TU -27500 to +27500: -027.500 to +027.500 mm LP-435U/435TU/425S9U/425S9TU -80000 to +80000: -080.000 to +080.000 mm					
			n+6 to n+7	Y offset						
			n+8 to n+9	Rotation angle -18000 to +18000: -180.00 to +180.00 deg						
			n+10	Laser power correction: 0 to 200%						
			n+11	Scan speed correction: 5 to 500%						
			Processing element setting	Reading of processing element setting (straight)	1 to 8 (PLC1 to 8)		n	Station number: 0 (fixed)		4
							n+1	Command: 31H		
n+2	Processing condition number: 0 to 7									
n+3	Processing element number: 0 to 31									
n+4	Element type 0: Straight									
n+5 to n+6	Start point X coordinate	LP-430U/430TU/420S9U/420S9TU/ 410U/410TU -55000 to +55000: -055.000 to +055.000 mm LP-431U/431TU/421S9U/421S9TU/ 411U/411TU -27500 to +27500: -027.500 to +027.500 mm LP-435U/435TU/425S9U/425S9TU -80000 to +80000: -080.000 to +080.000 mm								
n+7 to n+8	Start point Y coordinate									
n+9 to n+10	End point X coordinate	LP-430U/430TU/420S9U/420S9TU/ 410U/410TU -55000 to +55000: -055.000 to +055.000 mm LP-431U/431TU/421S9U/421S9TU/ 411U/411TU -27500 to +27500: -027.500 to +027.500 mm LP-435U/435TU/425S9U/425S9TU -80000 to +80000: -080.000 to +080.000 mm								
n+11 to n+12	End point Y coordinate									
n+13 to n+14	Dashed line: dash length	LP-430U/430TU/420S9U/420S9TU/ 410U/410TU 000010 to 110000: 000.010 to 110.000 mm LP-431U/431TU/421S9U/421S9TU/ 411U/411TU 000010 to 550000: 000.010 to 055.000 mm LP-435U/435TU/425S9U/425S9TU 000010 to 160000: 000.010 to 160.000 mm								
n+15 to n+16	Dashed line: space length	LP-430U/430TU/420S9U/420S9TU/ 410U/410TU 000000 to 110000: 000.000 to 110.000 mm LP-431U/431TU/421S9U/421S9TU/ 411U/411TU 000000 to 550000: 000.000 to 055.000 mm LP-435U/435TU/425S9U/425S9TU 000000 to 160000: 000.000 to 160.000 mm								

Contents		F0	F1 (= \$u n)		F2	
Processing element setting	Reading of processing element setting (circle)	1 to 8 (PLC1 to 8)	n	Station number: 0 (fixed)		4
			n+1	Command: 31H		
			n+2	Processing condition number: 0 to 7		
			n+3	Processing element number: 0 to 31		
			n+4	Element type 1: Circle		
			n+5 to n+6	Center X coordinate	LP-430U/430TU/420S9U/420S9TU/410U/410TU -55000 to +55000: -055.000 to +055.000 mm LP-431U/431TU/421S9U/421S9TU/411U/411TU	
			n+7 to n+8	Center Y coordinate	-27500 to +27500: -027.500 to +027.500 mm LP-435U/435TU/425S9U/425S9TU -80000 to +80000: -080.000 to +080.000 mm	
			n+9 to n+10	Radius	LP-430U/430TU/420S9U/420S9TU/410U/410TU 000010 to 110000: 000.010 to 110.000 mm LP-431U/431TU/421S9U/421S9TU/411U/411TU	
	n+11 to n+12	Dashed line: dash length	000010 to 550000: 000.010 to 055.000 mm LP-435U/435TU/425S9U/425S9TU 000010 to 160000: 000.010 to 160.000 mm			
	n+13 to n+14	Dashed line: space length	LP-430U/430TU/420S9U/420S9TU/410U/410TU 000000 to 110000: 000.000 to 110.000 mm LP-431U/431TU/421S9U/421S9TU/411U/411TU 000000 to 550000: 000.000 to 055.000 mm LP-435U/435TU/425S9U/425S9TU 000000 to 160000: 000.000 to 160.000 mm			
	Reading of processing element setting (arc)	1 to 8 (PLC1 to 8)	n	Station number: 0 (fixed)		4
			n+1	Command: 31H		
			n+2	Processing condition number: 0 to 7		
			n+3	Processing element number: 0 to 31		
			n+4	Element type 2: Arc		
			n+5 to n+6	Start point X coordinate	LP-430U/430TU/420S9U/420S9TU/410U/410TU -55000 to +55000: -055.000 to +055.000 mm LP-431U/431TU/421S9U/421S9TU/411U/411TU	
			n+7 to n+8	Start point Y coordinate	-27500 to +27500: -027.500 to +027.500 mm LP-435U/435TU/425S9U/425S9TU -80000 to +80000: -080.000 to +080.000 mm	
n+9 to n+10			End point X coordinate	LP-430U/430TU/420S9U/420S9TU/410U/410TU -55000 to +55000: -055.000 to +055.000 mm LP-431U/431TU/421S9U/421S9TU/411U/411TU		
n+11 to n+12			End point Y coordinate	-27500 to +27500: -027.500 to +027.500 mm LP-435U/435TU/425S9U/425S9TU -80000 to +80000: -080.000 to +080.000 mm		
n+13 to n+14	Radius	000010 to 300000: 000.010 to 300.000 mm				
n+15	Drawing direction	0: Counterclockwise 1: Clockwise				
n+16	Center angle	0: Less than 180 deg 1: 180 deg or more				

Contents		F0	F1 (= \$u n)			F2
Processing element setting	Reading of processing element setting (arc)	1 to 8 (PLC1 to 8)	n+17 to n+18	Dashed line: dash length	LP-430U/430TU/420S9U/420S9TU/410U/410TU 000010 to 110000: 000.010 to 110.000 mm LP-431U/431TU/421S9U/421S9TU/411U/411TU 000010 to 550000: 000.010 to 055.000 mm LP-435U/435TU/425S9U/425S9TU 000010 to 160000: 000.010 to 160.000 mm	4
			n+19 to n+20	Dashed line: space length	LP-430U/430TU/420S9U/420S9TU/410U/410TU 000000 to 110000: 000.000 to 110.000 mm LP-431U/431TU/421S9U/421S9TU/411U/411TU 000000 to 550000: 000.000 to 055.000 mm LP-435U/435TU/425S9U/425S9TU 000000 to 160000: 000.000 to 160.000 mm	
	Writing of processing element setting (straight)	1 to 8 (PLC1 to 8)	n	Station number: 0 (fixed)		17
			n+1	Command: B1H		
			n+2	Processing condition number: 0 to 7		
			n+3	Processing element number: 0 to 31		
			n+4	Element type 0: Straight		
			n+5 to n+6	Start point X coordinate	LP-430U/430TU/420S9U/420S9TU/410U/410TU -55000 to +55000: -055.000 to +055.000 mm LP-431U/431TU/421S9U/421S9TU/411U/411TU -27500 to +27500: -027.500 to +027.500 mm LP-435U/435TU/425S9U/425S9TU -80000 to +80000: -080.000 to +080.000 mm	
			n+7 to n+8	Start point Y coordinate		
			n+9 to n+10	End point X coordinate	LP-430U/430TU/420S9U/420S9TU/410U/410TU -55000 to +55000: -055.000 to +055.000 mm LP-431U/431TU/421S9U/421S9TU/411U/411TU -27500 to +27500: -027.500 to +027.500 mm LP-435U/435TU/425S9U/425S9TU -80000 to +80000: -080.000 to +080.000 mm	
			n+11 to n+12	End point Y coordinate		
			n+13 to n+14	Dashed line: dash length	LP-430U/430TU/420S9U/420S9TU/410U/410TU 000010 to 110000: 000.010 to 110.000 mm LP-431U/431TU/421S9U/421S9TU/411U/411TU 000010 to 550000: 000.010 to 055.000 mm LP-435U/435TU/425S9U/425S9TU 000010 to 160000: 000.010 to 160.000 mm	
			n+15 to n+16	Dashed line: space length	LP-430U/430TU/420S9U/420S9TU/410U/410TU 000000 to 110000: 000.000 to 110.000 mm LP-431U/431TU/421S9U/421S9TU/411U/411TU 000000 to 550000: 000.000 to 055.000 mm LP-435U/435TU/425S9U/425S9TU 000000 to 160000: 000.000 to 160.000 mm	

Contents		F0	F1 (= \$u n)		F2		
Processing element setting	Writing of processing element setting (circle)	1 to 8 (PLC1 to 8)	n	Station number: 0 (fixed)		15	
			n+1	Command: B1H			
			n+2	Processing condition number: 0 to 7			
			n+3	Processing element number: 0 to 31			
			n+4	Element type 1: Circle			
			n+5 to n+6	Center X coordinate	LP-430U/430TU/420S9U/420S9TU/410U/410TU -55000 to +55000: -055.000 to +055.000 mm LP-431U/431TU/421S9U/421S9TU/411U/411TU		
			n+7 to n+8	Center Y coordinate	-27500 to +27500: -027.500 to +027.500 mm LP-435U/435TU/425S9U/425S9TU -80000 to +80000: -080.000 to +080.000 mm		
			n+9 to n+10	Radius	LP-430U/430TU/420S9U/420S9TU/410U/410TU 000010 to 110000: 000.010 to 110.000 mm LP-431U/431TU/421S9U/421S9TU/411U/411TU		
			n+11 to n+12	Dashed line: dash length	000010 to 550000: 000.010 to 055.000 mm LP-435U/435TU/425S9U/425S9TU 000010 to 160000: 000.010 to 160.000 mm		
			n+13 to n+14	Dashed line: space length	LP-430U/430TU/420S9U/420S9TU/410U/410TU 000000 to 110000: 000.000 to 110.000 mm LP-431U/431TU/421S9U/421S9TU/411U/411TU 000000 to 550000: 000.000 to 055.000 mm LP-435U/435TU/425S9U/425S9TU 000000 to 160000: 000.000 to 160.000 mm		
			n	Station number: 0 (fixed)			21
			n+1	Command: B1H			
			n+2	Processing condition number: 0 to 7			
			n+3	Processing element number: 0 to 31			
n+4	Element type 2: Arc						
n+5 to n+6	Start point X coordinate	LP-430U/430TU/420S9U/420S9TU/410U/410TU -55000 to +55000: -055.000 to +055.000 mm LP-431U/431TU/421S9U/421S9TU/411U/411TU					
n+7 to n+8	Start point Y coordinate	-27500 to +27500: -027.500 to +027.500 mm LP-435U/435TU/425S9U/425S9TU -80000 to +80000: -080.000 to +080.000 mm					
n+9 to n+10	End point X coordinate	LP-430U/430TU/420S9U/420S9TU/410U/410TU -55000 to +55000: -055.000 to +055.000 mm LP-431U/431TU/421S9U/421S9TU/411U/411TU					
n+11 to n+12	End point Y coordinate	-27500 to +27500: -027.500 to +027.500 mm LP-435U/435TU/425S9U/425S9TU -80000 to +80000: -080.000 to +080.000 mm					
n+13 to n+14	Radius	000010 to 300000: 000.010 to 300.000 mm					
n+15	Drawing direction 0: Counterclockwise 1: Clockwise						
n+16	Center angle 0: Less than 180 deg 1: 180 deg or more						

Contents		F0	F1 (= \$u n)		F2
Processing element setting	Writing of processing element setting (arc)	1 to 8 (PLC1 to 8)	n+17 to n+18	Dashed line: dash length LP-430U/430TU/420S9U/420S9TU/410U/410TU 000010 to 110000: 000.010 to 110.000 mm LP-431U/431TU/421S9U/421S9TU/411U/411TU 000010 to 550000: 000.010 to 055.000 mm LP-435U/435TU/425S9U/425S9TU 000010 to 160000: 000.010 to 160.000 mm	21
			n+19 to n+20	Dashed line: space length LP-430U/430TU/420S9U/420S9TU/410U/410TU 000000 to 110000: 000.000 to 110.000 mm LP-431U/431TU/421S9U/421S9TU/411U/411TU 000000 to 550000: 000.000 to 055.000 mm LP-435U/435TU/425S9U/425S9TU 000000 to 160000: 000.000 to 160.000 mm	
Guide LD display		1 to 8 (PLC1 to 8)	n	Station number: 0 (fixed)	3
			n+1	Command: B2H	
			n+2	Display 0: Display stop 1: Center + print area 2: Print image 3: Dual pointer	
Week setting	Reading of week setting	1 to 8 (PLC1 to 8)	n	Station number: 0 (fixed)	2
			n+1	Command: 33H	
			n+2	Update day of the week 0: Sunday (updated at 0:00 midnight) 1: Monday (updated at 0:00 midnight)	
	Writing of week setting	1 to 8 (PLC1 to 8)	n	Station number: 0 (fixed)	4
			n+1	Command: B3H	
			n+2	Update day of the week 0: Sunday (updated at 0:00 midnight) 1: Monday (updated at 0:00 midnight)	
n+3	The first week 0: The week including and after January 1 1: The week including the first Thursday of January				

Contents		F0	F1 (= \$u n)		F2
Barcode print data (1-/2-byte characters)	Reading of barcode print data (1-byte characters)	1 to 8 (PLC1 to 8)	n	Station number: 0 (fixed)	6
			n+1	Command: 35H	
			n+2	Printing character 0: 1-byte character	
			n+3	Setting section 0: Composite 1D section, except for composite 1: Composite 2D section	
			n+4	Barcode number: 0 to 7	
			n+5	Set row number (2-D code): 1 to 9	
			n+6 to n+20	Barcode data	
	Reading of barcode print data (2-byte characters)	1 to 8 (PLC1 to 8)	n	Station number: 0 (fixed)	6
			n+1	Command: 35H	
			n+2	Printing character 1: 2-byte character	
			n+3	Setting section 0: Composite 1D section, except for composite 1: Composite 2D section	
			n+4	Barcode number: 0 to 7	
			n+5	Set row number (2-D code): 1 to 9	
			n+6 to n+35	Barcode data	
	Writing of barcode print data (1-byte characters)	1 to 8 (PLC1 to 8)	n	Station number: 0 (fixed)	6 + barcode data word count (15 words maximum)
			n+1	Command: B5H	
			n+2	Printing character 0: 1-byte character	
			n+3	Setting section 0: Composite 1D section, except for composite components 1: Composite 2D section	
			n+4	Barcode number: 0 to 7	
			n+5	Set row number (2-D code): 1 to 9	
			n+6 to n+20	Barcode data	
	Writing of barcode print data (2-byte characters)	1 to 8 (PLC1 to 8)	n	Station number: 0 (fixed)	6 + barcode data word count (30 words maximum)
			n+1	Command: B5H	
			n+2	Printing character 1: 2-byte character	
n+3			Setting section 0: Composite 1D section, except for composite 1: Composite 2D section		
n+4			Barcode number: 0 to 7		
n+5			Set row number (2-D code): 1 to 9		
n+6 to n+35			Barcode data		

 Return data: Data stored from controller to TS series

32.2.2 KW Series

Communication Setting

Editor

Communication setting

(Underlined setting: default)

Item	Setting	Remarks
Connection Mode	1 : 1/ <u>1</u> :n / Multi-link2 / Multi-link2 (Ethernet) / 1 : n Multi-link2 (Ethernet)	
Signal Level	RS-232C / <u>RS-422/485</u>	
Baud Rate	4800 / 9600 / <u>19200</u> / 38400 bps	
Data Length	7 / <u>8</u> bits	
Stop Bit	<u>1</u> / 2 bits	
Parity	None / <u>Odd</u> / Even	
Target Port No.	<u>1</u> to 99	
Header	% (<u>Header</u>) / < (Extension Header)	Model on which "< (Extension Header)" is available: KW1M-R

Eco-POWER METER

Communication parameters can be set by operating the keys on the Eco-POWER METER. For more information, refer to the manual for Eco-POWER METER.

KW1M/KW1M-H/KW8M

(Underlined setting: default)

Mode	Display	Item	Setting
MODE 3	PROT	Protocol setting mode	<u>MEWT: MEWTOCOL</u>
	NO.	Station number setting mode	<u>1</u> to 99
	SPD	Baud rate setting mode	4800: 4800 bps 9600: 9600 bps <u>19200: 19200 bps</u> 38400: 38400 bps
	FMT	Communication format setting mode	<u>8bit-o: data length 8 bits, odd parity</u> 7bit-n: data length 7 bits, without parity 7bit-E: data length 7 bits, even parity 7bit-o: data length 7 bits, odd parity 8bit-n: data length 8 bits, without parity 8bit-E: data length 8 bits, even parity

Stop bit: 1 (fixed)

KW1M-R(AKW1000/AKW1000K)

(Underlined setting: default)

Mode	Display	Item	Setting
MODE 3	PROT	Protocol setting mode	<u>MEWT: MEWTOCOL</u>
	SPD	Baud rate setting mode	4800: 4800 bps 9600: 9600 bps <u>19200: 19200 bps</u> 38400: 38400 bps
	FMT	Communication format setting mode	<u>8bit-o: data length 8 bits, odd parity</u> 7bit-n: data length 7 bits, without parity 7bit-E: data length 7 bits, even parity 7bit-o: data length 7 bits, odd parity 8bit-n: data length 8 bits, without parity 8bit-E: data length 8 bits, even parity
	PORT	Communication port setting mode	<u>232: RS-232C port</u> 485: RS-485 port

Stop bit: 1 (fixed)

AKW1000 and AKW1000K are not provided with the measuring function. Use each device along with a slave device AKW1131 or AKW1131K.

For establishing connection between master and slave devices, refer to the manual for Eco-POWER METER.

KW1M-R(AKW1131/AKW1131K)

(Underlined setting: default)

Mode	Display	Item	Setting
MODE 3	FORM	Wired/wireless setting mode	WIRED
	PROT	Protocol setting mode	<u>MEWT</u> : <u>MEWTOCOL</u>
	NO.	Station number setting mode	<u>1</u> to 99
	SPD	Baud rate setting mode	4800: 4800 bps 9600: 9600 bps <u>19200</u> : <u>19200 bps</u> 38400: 38400 bps
	FMT	Communication format setting mode	<u>8bit-o</u> : data length 8 bits, odd parity 7bit-n: data length 7 bits, without parity 7bit-E: data length 7 bits, even parity 7bit-o: data length 7 bits, odd parity 8bit-n: data length 8 bits, without parity 8bit-E: data length 8 bits, even parity

Stop bit: 1 (fixed)

* Use system program version 2.2 or later.

KW2G/KW2G-H

(Underlined setting: default)

Mode	Display	Item	Setting
MODE 3	PROT	Protocol setting mode	<u>MEWT</u> : <u>MEWTOCOL</u>
	NO	Station number setting mode	<u>1</u> to 99
	SPD	Baud rate setting mode	4800: 4800 bps 9600: 9600 bps <u>19200</u> : <u>19200 bps</u> 38400: 38400 bps
	FMT	Communication format setting mode	<u>8bit-o</u> : data length 8 bits, odd parity 7bit-n: data length 7 bits, without parity 7bit-E: data length 7 bits, even parity 7bit-o: data length 7 bits, odd parity 8bit-n: data length 8 bits, without parity 8bit-E: data length 8 bits, even parity
	STOP	Stop bit setting mode	<u>1</u> : 1 bit 2: 2 bits

KW4M

(Underlined setting: default)

Mode	Display	Item	Setting
MODE 3	NO.	Station setting mode	<u>1</u> to 99
	SPD	Baud rate setting mode	4800: 4800 bps 9600: 9600 bps <u>19200</u> : <u>19200 bps</u> 38400: 38400 bps
	FMT	Communication format setting mode	<u>8bit-o</u> : data length 8 bits, odd parity 7bit-n: data length 7 bits, without parity 7bit-E: data length 7 bits, even parity 7bit-o: data length 7 bits, odd parity 8bit-n: data length 8 bits, without parity 8bit-E: data length 8 bits, even parity

Protocol: MEWTOCOL, stop bit: 1 (fixed)

Terminal station setting

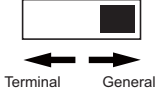
Slide Switch	Item	Setting
	Terminal station setting	General: General station Terminal: Terminal station

KW7M

(Underlined setting: default)

Mode	Display	Item	Setting
MODE 2	PROT	Protocol setting mode	<u>MEWT: MEWTOCOL</u>
	NO.	Station number setting mode	<u>1</u> to 99
	SPD	Baud rate setting mode	4800: 4800 bps 9600: 9600 bps <u>19200: 19200 bps</u> 38400: 38400 bps
	FMT	Communication format setting mode	<u>8bit-o: data length 8 bits, odd parity</u> 7bit-n: data length 7 bits, without parity 7bit-E: data length 7 bits, even parity 7bit-o: data length 7 bits, odd parity 8bit-n: data length 8 bits, without parity 8bit-E: data length 8 bits, even parity

Stop bit: 1 (fixed)

Available Memory

The available memory setting range varies depending on the models. Be sure to set within the range available for the device. Use [TYPE] when assigning the indirect memory for macro programs.

Memory	TYPE	Remarks
DT (data register)	00H	

PLC_CTL

Macro command "PLC_CTL F0 F1 F2"

Contents	F0	F1 (= \$u n)	F2	
Status read	1 to 8 (PLC1 to 8)	n	Station number: 1 to 99	2
		n+1	Command: 0000H	
		n+2	Model code 1	
		n+3	Model code 2	
		n+4	Version	
		n+5	Operation mode 0: Stopped 1: Running	
		n+6	Error flag 0: Normal 1: Error	
		n+7	Self-diagnosis error number	

Return data: Data stored from Eco-POWER METER to TS series

32.2.3 MINAS A4 Series

Communication Setting

Editor

Communication setting

(Underlined setting: default)

Item	Setting	Remarks
Connection Mode	1 : 1 / <u>1:n</u> / Multi-link2 / Multi-link2 (Ethernet) / 1 : n Multi-link2 (Ethernet)	
Signal Level	<u>RS-232C</u> / RS-422/485	
Baud Rate	4800 / <u>9600</u> / 19200 / 38400 / 57600 bps	
Data Length	<u>8 bits</u>	
Stop Bit	<u>1 bit</u>	
Parity	<u>None</u>	
Target Port No.	0 to 15	

Servo Amplifier

Communication parameters can be set by operating the rotary switch and the keys on the front panel. For more information, refer to the servo amplifier manual.

Setting changes will take effect after turning the power off and back on. If changes are made to any settings, turn the power off and on again.

Rotary switch (ID)

ID	Item	Setting
	Axis number setting	RS-232C connection: 0 to F RS-485 connection: 1 to F

Parameters

(Underlined setting: default)

Mode	Item	Setting
0C	RS-232C communication baud rate setting	1: 4800 bps <u>2: 9600 bps</u> 3: 19200 bps 4: 38400 bps 5: 57600 bps
0D	RS-485 communication baud rate setting	1: 4800 bps <u>2: 9600 bps</u> 3: 19200 bps 4: 38400 bps 5: 57600 bps

Data length: 8, stop bit: 1, parity: none (fixed)

Available Memory

The available memory setting range varies depending on the models. Be sure to set within the range available for the device. Use [TYPE] when assigning the indirect memory for macro programs.

Memory	TYPE	Remarks
STS (status)	00H	Read only
OPLSC (command pulse counter)	01H	Double-word, read only
FPLSC (feedback pulse counter)	02H	Double-word, read only
SPD (current speed)	03H	Read only
TLQ (current torque command)	04H	Read only
DEVIC (current deviation counter)	05H	Double-word, read only
INS (input signal)	06H	Double-word, read only
OUTS (output signal)	07H	Double-word, read only
STDC (current speed/torque/counter)	08H	Double-word, read only
SIO (status, input signal, output signal)	09H	Double-word, read only
FBS (feedback scale)	0AH	Read only
ABS (absolute encoder)	0BH	Double-word, read only
FSPLS (feedback scale deviation/total pulses)	0CH	Double-word, read only
IPM (parameter (individual))	0DH	* 1
CALM (current alarm data)	0EH	Read only
IALM (alarm history (individual))	0FH	Read only
AALM (alarm history (all))	10H	Read only
IAPM (parameter/property (individual))	11H	Read only
PAPM (parameter/property (all))	12H	Read only, except for parameter values (current values)*1

*1 Parameter values will be changed temporarily. When saving parameter changes to EEPROM, use the macro command PLC_CTL. For more information on the command PLC_CTL, see page 32-61.

Indirect Memory Designation

	15	8	7	0
n+0	Models (11 to 18)		Memory type	
n+1	Address No.			
n+2	Expansion code *		Bit designation	
n+3	00		Station number	

* In the expansion code, set which word, higher or lower, is to be read when a double-word address is specified.

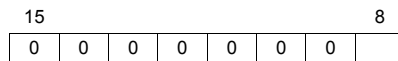

0: 0 to 15 bits (lower)
1: 16 to 31 bits (higher)

PLC_CTL

Macro command "PLC_CTL F0 F1 F2"

Contents	F0	F1 (= \$u n)		F2
Software version information readout	1 to 8 (PLC1 to 8)	n	Station number: 0 to 15	2
		n+1	Command: 0000H	
		n+2	Software version	
Amplifier model readout	1 to 8 (PLC1 to 8)	n	Station number: 0 to 15	2
		n+1	Command: 0001H	
		n+2	Model code 1st and 2nd characters	
		n+3	Model code 3rd and 4th characters	
		n+4	Model code 5th and 6th characters	
		n+5	Model code 7th and 8th characters	
		n+6	Model code 9th and 10th characters	
Motor model readout	1 to 8 (PLC1 to 8)	n	Station number: 0 to 15	2
		n+1	Command: 0002H	
		n+2	Model code 1st and 2nd characters	
		n+3	Model code 3rd and 4th characters	
		n+4	Model code 5th and 6th characters	
		n+5	Model code 7th and 8th characters	
		n+6	Model code 9th and 10th characters	
RS-232 protocol parameter setting	1 to 8 (PLC1 to 8)	n	Station number: 0 to 15	5
		n+1	Command: 0003H	
		n+2	Timeout period between characters 1 to 255 (unit: 0.1 sec.)	
		n+3	Protocol timeout period 1 to 255 (unit: 1 sec.)	
		n+4	Retry limit (unit: 1 time)	
RS-485 protocol parameter setting	1 to 8 (PLC1 to 8)	n	Station number: 0 to 15	5
		n+1	Command: 0004H	
		n+2	Timeout period between characters 1 to 255 (unit: 0.1 sec.)	
		n+3	Protocol timeout period 1 to 255 (unit: 1 sec.)	
		n+4	Retry limit (unit: 1 time)	
Execute privilege acquisition/release	1 to 8 (PLC1 to 8)	n	Station number: 0 to 15	3
		n+1	Command: 0005H	
		n+2	0: Request for execute privilege release 1: Request for execute privilege acquisition	
Parameter write to EEPROM	1 to 8 (PLC1 to 8)	n	Station number: 0 to 15	2
		n+1	Command: 0006H	
Alarm history clear	1 to 8 (PLC1 to 8)	n	Station number: 0 to 15	2
		n+1	Command: 0007H	
Alarm clear	1 to 8 (PLC1 to 8)	n	Station number: 0 to 15	2
		n+1	Command: 0008H	
Absolute clear	1 to 8 (PLC1 to 8)	n	Station number: 0 to 15	2
		n+1	Command: 0009H	

Return data: Data stored from servo amplifier to TS series

32.2.4 Wiring Diagrams

When Connected at COM1:

RS-485

Wiring diagram 1 - COM1

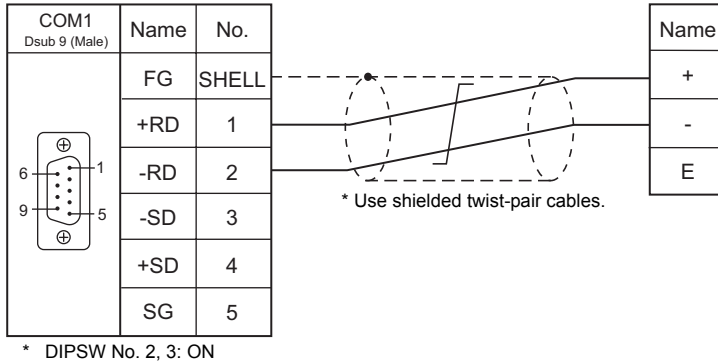

Eco-POWER METER connected at the terminal (except for KW4M)

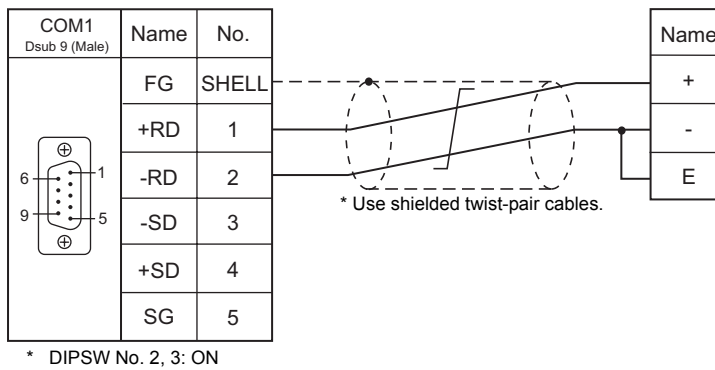

Wiring diagram 2 - COM1

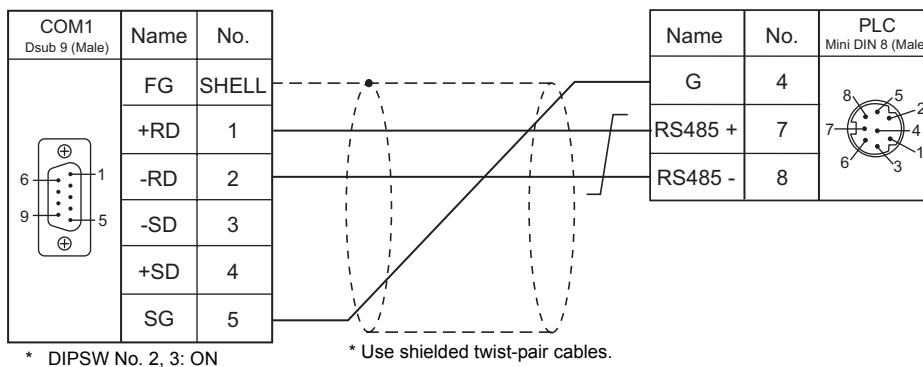

When Connected at COM2:

RS-232C

Wiring diagram 1 - COM2

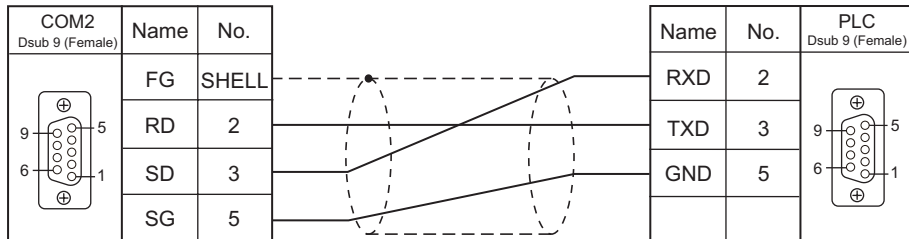

* Use shielded twist-pair cables.

Wiring diagram 2 - COM2

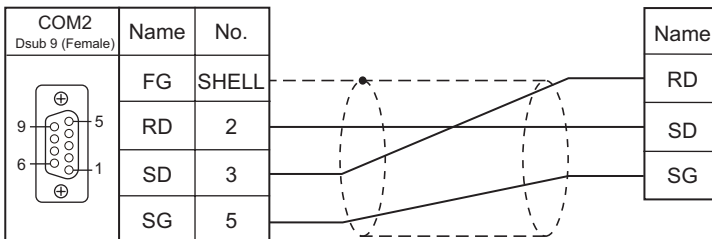

* Use shielded twist-pair cables.

Wiring diagram 3 - COM2

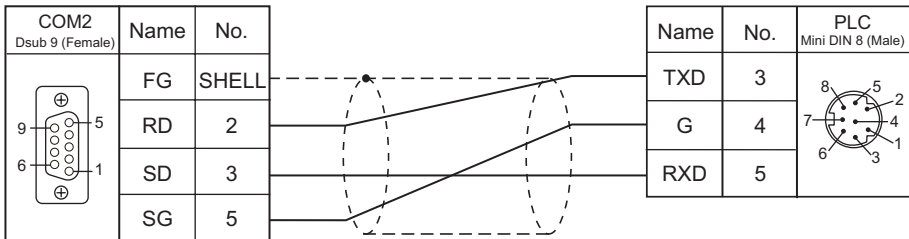

* Use shielded twist-pair cables.

When Connected at COM3:

RS-485

Wiring diagram 1 - COM3

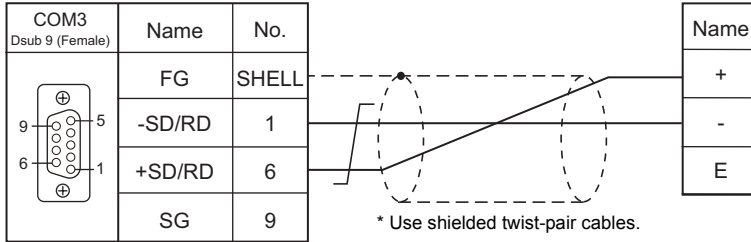

Eco-POWER METER connected at the terminal (except for KW4M)

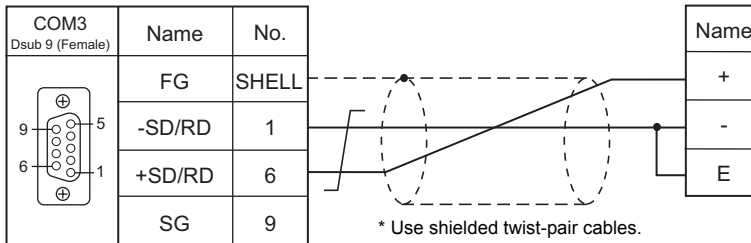

Wiring diagram 2 - COM3

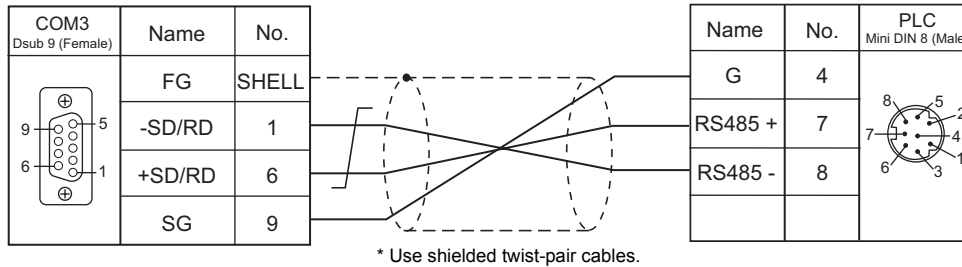

33. RKC

33.1 Temperature Controller/Servo/Inverter Connection

33.1 Temperature Controller/Servo/Inverter Connection

Serial Connection

Module-type Temperature Controller

PLC Selection on the Editor	Model	Port	Signal Level	TS Port	Connection	Lst File
SR-Mini (MODBUS RTU)	H-PCP-A-x4N-4 * xx Z-1021	Modular connector 1/2	RS-422A	COM1	Wiring diagram 2 - COM1	SR-Mini.Lst
	H-PCP-B-x4N-4 * xx Z-1021			COM3	Wiring diagram 2 - COM3	
SR-Mini (Standard Protocol)	H-PCP-A-x4N-4 * xx	Modular connector 1/2	RS-422A	COM1	Wiring diagram 2 - COM1	RKC_Std.Lst
	H-PCP-B-x4N-4 * xx			COM3	Wiring diagram 2 - COM3	
SRV (MODBUS RTU)	V-TIO-A-xxxx-xx*xxx-xx-x-6	Communication terminal	RS-485 (2-wire system)	COM1	Wiring diagram 1 - COM1	RKC_SRV.Lst
	V-TIO-C-xxxx-xx*xxx-xx-x-6			COM3	Wiring diagram 1 - COM3	
SRZ (MODBUS RTU)	Z-TIO-A-x-xxxx/x2-x xxx/Y*1	Communication terminal	RS-485 (2-wire system)	COM1	Wiring diagram 1 - COM1	RKC_SRZ_TIO.Lst
	Z-TIO-B-x-xx/xN2-xxxx/Y*1			COM3	Wiring diagram 1 - COM3	
	Z-DIO-A-x-xx/x-xxx2	Communication terminal	RS-485 (2-wire system)	COM1	Wiring diagram 1 - COM1	RKC_SRZ_DIO.Lst
				COM3	Wiring diagram 1 - COM3	

*1 Select a model on which Modbus communication is available.

2: Modbus for the communication protocol is selectable in the initial setting code when "specify quick start code 1 and 2" is selected as the quick start code.

Single Loop Temperature Controller

PLC Selection on the Editor	Model	Port	Signal Level	TS Port	Connection	Lst File
CB100/CB400/CB500/CB700/CB900 (MODBUS RTU)	CB100xxxx-xx*xx-5x/x Z-1021	Communication terminal	RS-485	COM1	Wiring diagram 1 - COM1	CB100.Lst
	CB400xxxx-xx*xx-5x/x Z-1021			COM3	Wiring diagram 1 - COM3	
	CB500xxxx-xx*xx-5x/x Z-1021					
	CB700xxxx-xx*xx-5x/x Z-1021					
	CB900xxxx-xx*xx-5x/x Z-1021					
REX-F400/F700/F900 (Standard Protocol)	F400xxxx-xx*xx-xxx-1x	Communication terminal	RS-232C	COM2	Wiring diagram 1 - COM2	RKC_F400.Lst
	F700xxxx-xx*xx-xxx-1x	Communication terminal	RS-422A	COM1	Wiring diagram 3 - COM1	
	F900xxxx-xx*xx-xxx-1x			COM3	Wiring diagram 3 - COM3	
	F400xxxx-xx*xx-xxx-4x			COM1	Wiring diagram 1 - COM1	
	F700xxxx-xx*xx-xxx-4x	Communication terminal	RS-485	COM3	Wiring diagram 1 - COM3	
	F900xxxx-xx*xx-xxx-4x					
FB100/FB400/FB900 (MODBUS RTU)	FB400-xx-x*xxx1/xx-xxxx	Communication terminal	RS-232C	COM2	Wiring diagram 1 - COM2	RKC_FB.Lst
	FB400-xx-x*xxxW/xx-xxxx	Communication terminal	RS-422A	COM1	Wiring diagram 3 - COM1	
	FB900-xx-x*xxx1/xx-xxxx			COM3	Wiring diagram 3 - COM3	
	FB900-xx-x*xxxW/xx-xxxx	Communication terminal	RS-485	COM1	Wiring diagram 1 - COM1	
	FB100-xx-x*E/xx-xxxx			COM3	Wiring diagram 1 - COM3	
	FB100-xx-x*F/xx-xxxx					
	FB100-xx-x*G/xx-xxxx					
	FB100-xx-x*H/xx-xxxx					
	FB100-xx-x*J/xx-xxxx					
	FB400-xx-x*xxx5/xx-xxxx					
FB400-xx-x*xxxW/xx-xxxx						
FB400-xx-x*xxxX/xx-xxxx						
FB400-xx-x*xxxY/xx-xxxx						
FB900-xx-x*xxx5/xx-xxxx						
FB900-xx-x*xxxW/xx-xxxx						
FB900-xx-x*xxxX/xx-xxxx						
FB900-xx-x*xxxY/xx-xxxx						

Multi-loop Temperature Controller

PLC Selection on the Editor	Model	Port	Signal Level	TS Port	Connection	Lst File
MA900/MA901 (MODBUS RTU)	MA900-4xxxx-xx-x*xxx-x6/x	Communication terminal	RS-485	COM1	Wiring diagram 1 - COM1	RKC_MA900.Lst
	MA901-8xxxx-xx-x*xxx-x6/x			COM3	Wiring diagram 1 - COM3	RKC_MA901.Lst

33.1.1 CB100/CB400/CB500/CB700/CB900 (MODBUS RTU)

Communication Setting

Editor

Communication setting

(Underlined setting: default)

Item	Setting	Remarks
Connection Mode	1 : 1 / <u>1:n</u> / Multi-link2	
Signal Level	<u>RS-422/485</u>	
Baud Rate	4800 / <u>9600</u> / 19200 bps	
Parity	<u>None</u> / Odd / Even	
Data Length	8 bits	
Stop Bit	1 bit	
Target Port No.	1 to 31	

CB100

Communication setting mode

When the [R/S] key is pressed while the [SET] key is held down in the PV/SV display mode, the controller enters in the "communication setting" mode.

(Underlined setting: default)

Indication	Item	Setting	Remarks
Add	Slave address	1 to 31	Communication is not performed when "0" is set.
bPS	Baud rate	1: 4800 bps <u>2: 9600 bps</u> 3: 19200 bps	
blT	Data configuration	<u>0: 8 bits / 1 bit / none</u> 6: 8 bits / 1 bit / even 7: 8 bits / 1 bit / odd	
InT	Interval time setting	0 to 150	Interval time = set value × 1.666 ms

Available Memory

The available memory setting range varies depending on the controller model. Be sure to set within the range available for the controller. Use [TYPE] when assigning the indirect memory for macro programs.

Memory	TYPE	Remarks
---	00H	

33.1.2 SRV (MODBUS RTU)

Communication Setting

Editor

Communication setting

(Underlined setting: default)

Item	Setting	Remarks
Connection Mode	1 : 1 / <u>1:n</u> / Multi-link2	
Signal Level	RS-232C / <u>RS-422/485</u>	
Baud Rate	9600 / 19200 / <u>38400</u> bps	
Data Length	8 bits	
Stop Bit	1 bit	
Parity	<u>None</u> / Odd / Even	
Target Port No.	1 to 31	

SRV

Address setting switch

(Underlined setting: default)

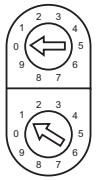
Switch	Setting	Remarks
	<u>00</u> to 30	<p>Higher-order digit setting (× 10) Lower-order digit setting (× 1)</p> <p>The number that is one greater than the set value is the address.</p>

DIP switch setting

Switch	Setting	Contents	Remarks
1	ON	Baud rate: 38400 bps	ON, OFF: 9600 bps OFF, ON: 19200 bps
2	ON		
3	ON	Data bit configuration 8 bits / 1 bit / without parity	ON, OFF, ON: 8 bits / 1 bit / even ON, ON, ON: 8 bits / 1 bit / odd
4	OFF		
5	OFF		
6	ON	Protocol: Modbus	
7	OFF	-	
8	OFF	-	

* Communication time settings (send changeover time/data interval delay time) can be made using the switches 4, 5, and 6. For more information, refer to the communication instruction manual for SRV.

Available Memory

The available memory setting range varies depending on the controller model. Be sure to set within the range available for the controller. Use [TYPE] when assigning the indirect memory for macro programs.

Memory	TYPE	Remarks
---	00H	

33.1.3 SR-Mini (MODBUS RTU)

Communication Setting

Editor

Communication setting

(Underlined setting: default)

Item	Setting	Remarks
Connection Mode	1 : 1 / <u>1:n</u> / Multi-link2	
Signal Level	RS-232C / <u>RS-422/485</u>	
Baud Rate	<u>9600</u> / 19200 bps	
Data Length	8 bits	
Stop Bit	1 bit	
Parity	<u>None</u> / Odd / Even	
Target Port No.	1 to 16	

SR-Mini

DIP switch

Switch	Setting	Contents	Remarks
1	ON	Modbus communication 8 bits / 1 bit / without parity	
2	ON		
3	ON	Baud rate: 9600 bps	OFF, ON: 4800 bps ON, ON: 19200 bps
4	OFF		

Slave address setting switch

(Underlined setting: default)

Switch	Setting	Remarks
	<u>Q</u> to F (= 1 to 16)	The number that is one greater than the set value is the address.

Available Memory

The available memory setting range varies depending on the controller model. Be sure to set within the range available for the controller. Use [TYPE] when assigning the indirect memory for macro programs.

Memory	TYPE	Remarks
---	00H	

33.1.4 SR-Mini (Standard Protocol)

Communication Setting

Editor

Communication setting

(Underlined setting: default)

Item	Setting	Remarks
Connection Mode	1 : 1 / <u>1:n</u> / Multi-link2	
Signal Level	RS-232C / <u>RS-422/485</u>	
Baud Rate	<u>9600</u> / 19200 bps	
Data Length	7 / <u>8</u> bits	
Stop Bit	<u>1</u> / 2 bits	
Parity	<u>None</u> / Odd / Even	
Target Port No.	0 to 15	

SR-Mini

DIP switch

Switch	Setting	Contents	Remarks
1	OFF	8 bits / 1 bit / without parity	OFF, ON: 7 bits, even parity ON, OFF: 7 bits, odd parity
2	OFF		
3	ON	Baud rate: 9600 bps	OFF, ON: 4800 bps ON, ON: 19200 bps
4	OFF		

Unit address setting switch

(Underlined setting: default)

Switch	Setting	Remarks
	<u>0</u> to F (= 0 to 15)	

Available Memory

The available memory setting range varies depending on the controller model. Be sure to set within the range available for the controller. Use [TYPE] when assigning the indirect memory for macro programs.

Memory	TYPE	Remarks
GRP0 (normal: R)	00H	Read only
GRP1 (normal: RW)	01H	
GRP2 (initial: R)	02H	Read only
GRP3 (initial: RW)	03H	

* On the signal name reference list, every channel number is designated as "00".
Manually enter the value obtained by the following procedure: subtract "1" from the channel to access, and set the hexadecimal number of the obtained value.
The assigned memory is indicated on the editor as shown on the right.

Example: GRP0000001 (measurement value for CH2 temperature)
Channel number: -1 (HEX)
Address

33.1.5 REX-F400/F700/F900 (Standard Protocol)

Communication Setting

Editor

Communication setting

(Underlined setting: default)

Item	Setting	Remarks
Connection Mode	1 : 1 / <u>1:1</u> / Multi-link2 / Multi-link2 (Ethernet)	
Signal Level	RS-232C / <u>RS-422/485</u>	
Baud Rate	4800 / <u>9600</u> / 19200 bps	
Data Length	<u>7</u> / 8 bits	
Stop Bit	1 / <u>2</u> bits	
Parity	None / <u>Odd</u> / Even	
Target Port No.	0 to 31	

REX-F400/F700/F900

Parameter group (PG) 24

The communication parameters can be set using keys attached to the temperature controller. Be sure to match the settings to those made on the [Communication Setting] tab window of the editor.

(Underlined setting: default)

Indication	Item	Setting	Remarks
bIT	Communication data bit configuration	0: 8 bits / 1 bit / none 1: 8 bits / 2 bits / none 2: 8 bits / 1 bit / even 3: 8 bits / 2 bits / even 4: 8 bits / 1 bit / odd 5: 8 bits / 2 bits / odd 6: 7 bits / 1 bit / none 7: 7 bits / 2 bits / none 8: 7 bits / 1 bits / even 9: 7 bits / 2 bits / even 10: 7 bits / 1 bit / odd 11: <u>7 bits / 2 bits / odd</u>	
Add	Device address	<u>0</u> to 31	
bPS	Baud rate	2: 4800 bps 3: <u>9600 bps</u> 4: 19200 bps	
InT	Interval time setting	<u>0</u> to 250 msec	

- * The "COMP" mode must be selected for communication with the TS series.
Press the [MODE] key to display "Computer Mode Change", and change the mode from [LOC] to [COMP] by pressing the [√] key.

Available Memory

The available memory setting range varies depending on the controller model. Be sure to set within the range available for the controller. Use [TYPE] when assigning the indirect memory for macro programs.

Memory	TYPE	Remarks
GRP0	00H	Read only
GRP1	01H	

33.1.6 MA900 / MA901 (MODBUS RTU)

Communication Setting

Editor

Communication setting

(Underlined setting: default)

Item	Setting	Remarks
Connection Mode	1 : 1 / <u>1:n</u> / Multi-link2	
Signal Level	RS-232C / <u>RS-422/485</u>	
Baud Rate	4800 / <u>9600</u> / 19200 bps	
Data Length	8 bits	
Stop Bit	1 bit	
Parity	<u>None</u> / Odd / Even	
Target Port No.	1 to 31	

MA900/MA901

Setup setting mode

When the [R/S] key is pressed while the [SET] key is held down in the PV/SV monitor mode, the controller enters in the "setup setting" mode.

(Underlined setting: default)

Indication	Item	Setting	Remarks
Add	Slave address	1 to 31	Communication is not performed when "0" is set.
bPS	Baud rate	1: 4800 bps 2: <u>9600 bps</u> 3: 19200 bps	
bIT	Data configuration	0: <u>8 bits / 1 bit / none</u> 2: 8 bits / 1 bit / even 4: 8 bits / 1 bit / odd	
InT	Interval time setting	0 to 250 msec	

Available Memory

The available memory setting range varies depending on the controller model. Be sure to set within the range available for the controller. Use [TYPE] when assigning the indirect memory for macro programs.

Memory	TYPE	Remarks
---	00H	

33.1.7 SRZ (MODBUS RTU)

Communication Setting

Editor

Communication setting

(Underlined setting: default)

Item	Setting	Remarks
Connection Mode	1 : 1 / <u>1:n</u> / Multi-link2	
Signal Level	RS-232C / <u>RS-422/485</u>	
Baud Rate	4800 / 9600 / <u>19200</u> / 38400 bps	
Data Length	8 bits	
Stop Bit	1 bit	
Parity	<u>None</u> / Odd / Even	
Target Port No.	Z-TIO: 1 to 16 Z-DIO: 17 to 31	Default: 1

SRZ

DIP switch

Switch	Setting	Contents	Remarks
1	OFF	Baud rate: 19200 bps	OFF, OFF: 4800 bps ON, OFF: 9600 bps OFF, ON: 19200 bps ON, ON: 38400 bps
2	ON		
3	OFF	Data bit configuration 8 bits / without parity / 1 bit	OFF, ON, ON: 8 bits / even / 1 bit ON, ON, ON: 8 bits / odd / 1 bit
4	OFF		
5	ON		
6	ON	Protocol: Modbus	
7	OFF	-	
8	OFF	-	

Slave address setting switch

(Underlined setting: default)

Switch	Setting	Remarks
	<u>Q</u> to F	For Z-TIO, the number that is one greater than the set value is the address. (Range: 1 to 16) For Z-DIO, the number that is seventeen greater than the set value is the address. (Range: 17 to 32*)

* For connection to TS, the available address setting range is 0 to E (17 to 31).

Available Memory

The available memory setting range varies depending on the controller model. Be sure to set within the range available for the controller. Use [TYPE] when assigning the indirect memory for macro programs.

Memory	TYPE	Remarks
---	00H	

33.1.8 FB100/FB400/FB900 (MODBUS RTU)

Communication Setting

Editor

Communication setting

(Underlined setting: default)

Item	Setting	Remarks
Connection Mode	1 : 1 / <u>1:n</u> / Multi-link2 / Multi-link2 (Ethernet) / 1 : n multi-link2 (Ethernet)	
Signal Level	RS-232C / <u>RS-422/485</u>	
Baud Rate	4800 / 9600 / <u>19200</u> / 38400 bps	
Data Length	8 bits	
Stop Bit	<u>1</u> / 2 bits	
Parity	<u>None</u> / Odd / Even	
Target Port No.	1 to 31	

FB100/FB400/FB900

The communication parameters can be set using keys attached to the temperature controller. Be sure to match the settings to those made on the [Communication Setting] tab window of the editor.

Communication protocol (engineering mode F60)

Indication	Item	Setting	Remarks
CMP1	Communication 1 protocol	1: MODBUS	
CMP2	Communication 2 protocol	1: MODBUS	

* The temperature controller must be set to "STOP" (control stop) before making settings.

Communication parameter (setup setting mode)

(Underlined setting: default)

Port	Indication	Item	Setting	Remarks
Communication 1	Add1	Device address 1	1 to 31	Communication is not performed when "0" is set.
	bPS1	Baud rate 1	4.8: 4800 bps 9.6: 9600 bps <u>19.2: 19200 bps</u> 38.4: 38400 bps	
	bit1	Data bit configuration 1	<u>8n1: 8 bits / none / 1 bit</u> 8n2: 8 bits / none / 2 bits 8E1: 8 bits / even parity / 1 bit 8E2: 8 bits / even parity / 2 bits 8o1: 8 bits / odd parity / 1 bit 8o2: 8 bits / odd parity / 2 bits	
	InT1	Interval time 1	0 to 250 msec	
Communication 2	Add2	Device address 2	1 to 31	Communication is not performed when "0" is set.
	bPS2	Baud rate 2	4.8: 4800 bps 9.6: 9600 bps <u>19.2: 19200 bps</u> 38.4: 38400 bps	
	bit2	Data bit configuration 2	<u>8n1: 8 bits / none / 1 bit</u> 8n2: 8 bits / none / 2 bits 8E1: 8 bits / even parity / 1 bit 8E2: 8 bits / even parity / 2 bits 8o1: 8 bits / odd parity / 1 bit 8o2: 8 bits / odd parity / 2 bits	
	InT2	Interval time 2	0 to 250 msec	

Parameter changes will take effect when the temperature controller is turned off and on again or is switched from "STOP" to "RUN".

Available Memory

The available memory setting range varies depending on the controller model. Be sure to set within the range available for the controller.

Use [TYPE] when assigning the indirect memory for macro programs.

Memory	TYPE	Remarks
---	00H	0000 to 0017: Read only

33.1.9 Wiring Diagrams

When Connected at COM1:

RS-422/RS-485

Wiring diagram 1 - COM1

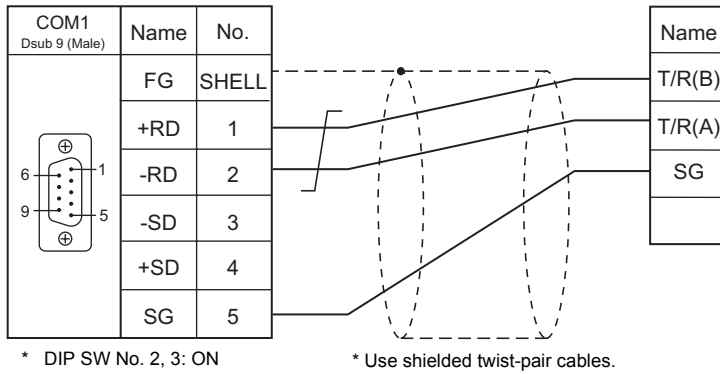

Wiring diagram 2 - COM1

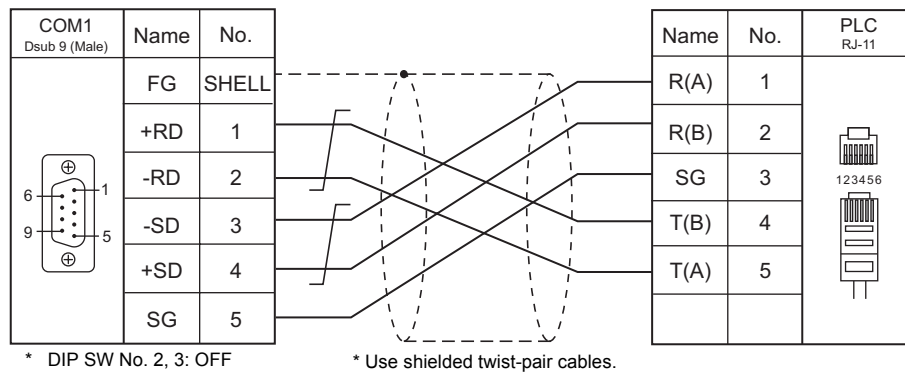

Wiring diagram 3 - COM1

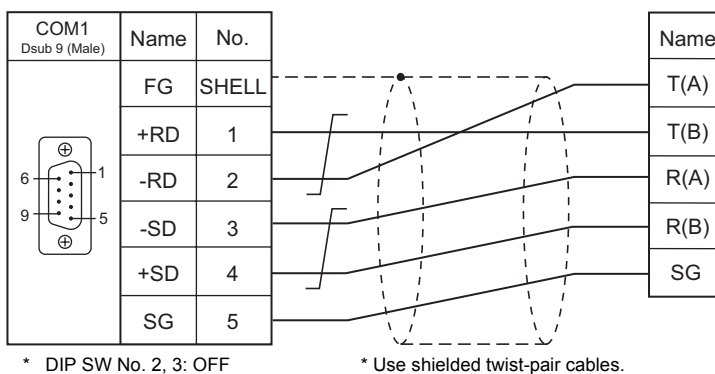

When Connected at COM2:

RS-232C

Wiring diagram 1 - COM2

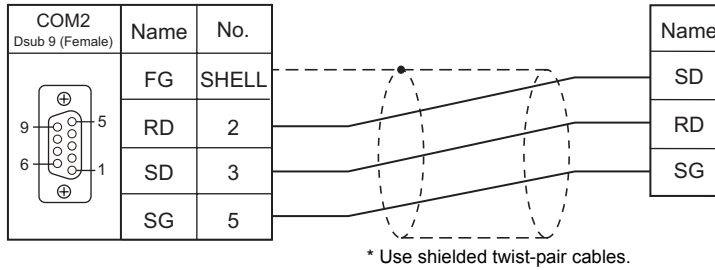

When Connected at COM3:

RS-485

Wiring diagram 1 - COM3

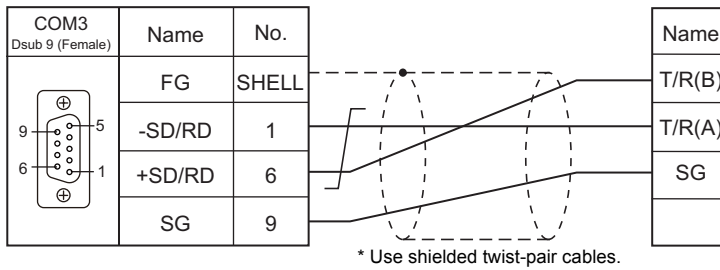

Wiring diagram 2 - COM3

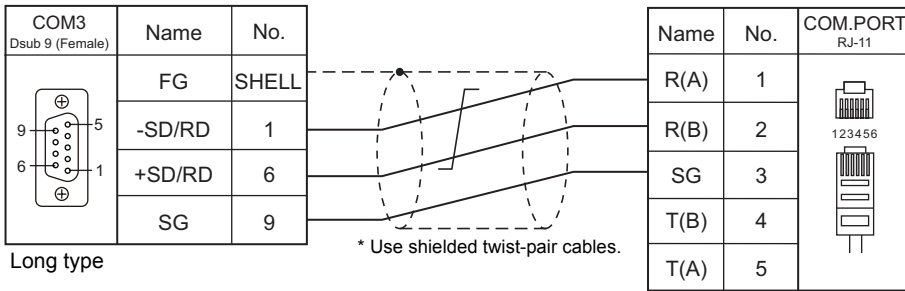

Long type

Short type

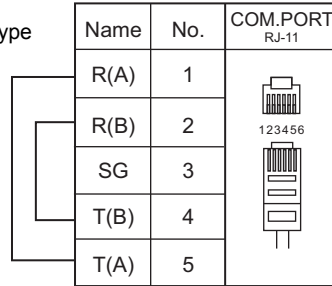

Use a long-type cable to connect a controller with COM3 of the TS unit.
 Use RKC's cables for connection between controllers.
 Use a short-type cable to connect the controller at the terminal.

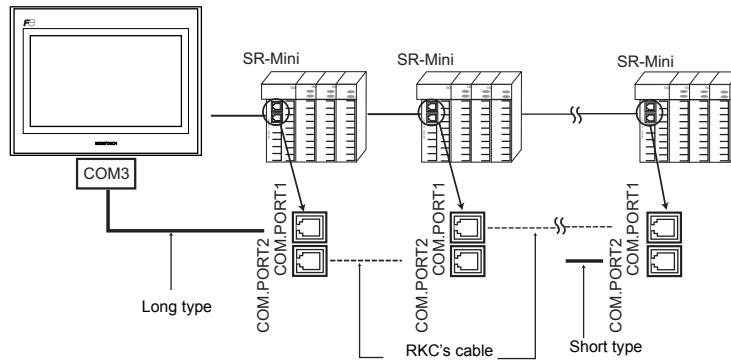

Wiring diagram 3 - COM3

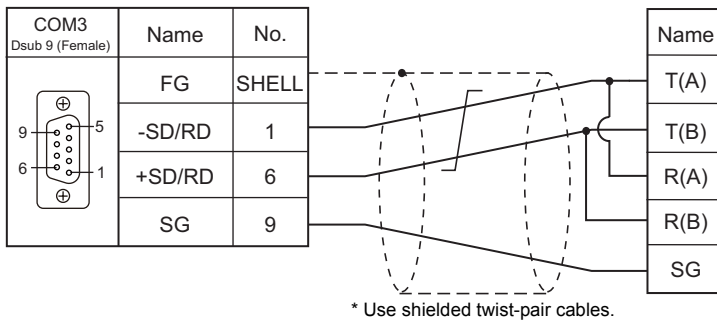

MEMO

Please use this page freely.

34. RS Automation

34.1 PLC Connection

34.1 PLC Connection

Serial Connection

PLC Selection on the Editor	CPU		Unit/Port	Signal Level	TS Port	Connection	Ladder Transfer*1	
NX7/NX Plus Series (70P/700P/CCU+)	NX70 plus	NX70-CPU70p1	COM port	RS-232C	COM2	Wiring diagram 1 - COM2	X	
				RS-485	COM1	Wiring diagram 1 - COM1		
			COM3	Wiring diagram 1 - COM3				
			NX70-CCU+(CCU)	RS-232C	COM2	Wiring diagram 1 - COM2		
				RS-485	COM1	Wiring diagram 1 - COM1		
				COM3	Wiring diagram 1 - COM3			
		NX70-CPU70p2	COM1/COM2	RS-232C	COM2	Wiring diagram 1 - COM2		
				RS-485	COM1	Wiring diagram 1 - COM1		
			COM3	Wiring diagram 1 - COM3				
			NX70-CCU+(CCU)	RS-232C	COM2	Wiring diagram 1 - COM2		
				RS-485	COM1	Wiring diagram 1 - COM1		
				COM3	Wiring diagram 1 - COM3			
	NX700 plus	NX-CPU700p	COM1/COM2	RS-232C	COM2	Wiring diagram 1 - COM2		
				RS-485	COM1	Wiring diagram 1 - COM1		
			COM3	Wiring diagram 1 - COM3				
		NX-CCU+(CCU)	RS-232C	COM2	Wiring diagram 1 - COM2			
			RS-485	COM1	Wiring diagram 1 - COM1			
			COM3	Wiring diagram 1 - COM3				
	NX7	NX7-xxxDx NX7R-xxADx	COM1	RS-232C	COM2	Wiring diagram 2 - COM2		
				RS-485	COM1	Wiring diagram 2 - COM1		
				COM3	Wiring diagram 2 - COM3			
			COM2	RS-232C	COM2	Wiring diagram 3 - COM2		
				RS-485	COM1	Wiring diagram 3 - COM1		
				COM3	Wiring diagram 3 - COM3			
NX7S-xxxDx		COM1	RS-232C	COM2	Wiring diagram 1 - COM2			
			RS-485	COM1	Wiring diagram 3 - COM1			
		COM2	RS-485	COM3	Wiring diagram 3 - COM3			
			COM3	Wiring diagram 3 - COM3				
		N7/NX Series (70/700/750/CCU)	N70	CPL9211A	COM port	RS-232C	COM2	Wiring diagram 4 - COM2
						RS-422	COM1	Wiring diagram 4 - COM1
CPL9462(CCUC)	RS-232C			COM2	Wiring diagram 5 - COM2			
N70α	CPL9210A		COM port	RS-232C	COM2	Wiring diagram 6 - COM2		
				COM2	Wiring diagram 5 - COM2			
N700	CPL7210A CPL7211A		COM port	RS-232C	COM2	Wiring diagram 4 - COM2		
				RS-422	COM1	Wiring diagram 4 - COM1		
	CPL7462(CCUC)		RS-232C	COM2	Wiring diagram 5 - COM2			
N700α	CPL6210A CPL6210B		TOOL port	RS-232C	COM2	Wiring diagram 5 - COM2		
			COM port		COM2	Wiring diagram 7 - COM2		
			CPL7462(CCUC)		COM2	Wiring diagram 5 - COM2		
N7000	CPL5221B CPL5231		COM port	RS-232C	COM2	Wiring diagram 4 - COM2		
				RS-422	COM1	Wiring diagram 4 - COM1		
	CPL5462(CCUC)		RS-232C	COM2	Wiring diagram 5 - COM2			
N7000α	CPL4210 CPL4211		COM1	RS-422	COM1	Wiring diagram 4 - COM1		
			COM2	RS-232C	COM2	Wiring diagram 7 - COM2		
			CPL5462(CCUC)		COM2	Wiring diagram 5 - COM2		
NX70	NX70-CPU70		TOOL port	RS-232C	COM2	Wiring diagram 1 - COM2		
			NX70-CCU(CCUC)		COM2	Wiring diagram 8 - COM2		
	NX70-CPU750		TOOL port	RS-232C	COM2	Wiring diagram 1 - COM2		
			COM port		COM2	Wiring diagram 8 - COM2		
			NX70-CCU(CCUC)					
			COM port					
NX700	NX-CPU750A NX-CPU750B NX-CPU750C NX-CPU750D		TOOL port	RS-232C	COM2	Wiring diagram 1 - COM2		
		COM port	COM2		Wiring diagram 8 - COM2			
		NX-CCU(CCUC)						
	NX-CPU700	TOOL port	RS-232C	COM2	Wiring diagram 1 - COM2			
NX-CCU(CCUC)	COM2	Wiring diagram 8 - COM2						

PLC Selection on the Editor	CPU	Unit/Port	Signal Level	TS Port	Connection	Ladder Transfer ^{*1}
X8 Series	X8-M16DDR X8-M14DDT X8-M32DDT	COM0/COM1	RS-232C	COM2	Wiring diagram 9 - COM2	×
			RS-485	COM1	Wiring diagram 5 - COM1	
				COM3	Wiring diagram 4 - COM3	

*1 For the ladder transfer function, see "Appendix 5 Ladder Transfer Function".

Ethernet Connection

PLC Selection on the Editor	CPU	Unit	TCP/IP	UDP/IP	Port No.	Ladder Transfer ^{*1}
NX700 Series (Ethernet)	NX-CPU750A NX-CPU750B NX-CPU750C NX-CPU750D	NX-Ethernet	○	○	As desired ^{*2}	×
X8 Series (Ethernet)	X8-M16DDR X8-M14DDT X8-M32DDT	CPU with built-in Ethernet	○	×	50000 (fixed) (Max. 16 units)	

*1 For the ladder transfer function, see "Appendix 5 Ladder Transfer Function".

*2 Eight connection settings are provided on the PLC; each for one TS unit. Therefore, a maximum of eight TS units can be connected to an Ethernet unit.

34.1.1 NX7/NX Plus Series (70P/700P/CCU+)

Communication Setting

Editor

Communication setting

(Underlined setting: default)

Item	Setting	Remarks
Connection Mode	<u>1:1</u> / 1 : n / Multi-link / Multi-link2 / Multi-link2 (Ethernet) / 1 : n Multi-link2 (Ethernet)	
Signal Level	<u>RS-232C</u> / RS-422/485	For RS-485 connection, set the transmission delay time to 3 msec or longer.
Baud Rate	4800 / <u>9600</u> / 19200 / 38400 / 57600 /115K bps	57600 bps and 115K bps supported by NX7R only
Data Length	8 bits	
Stop Bit	1 bit	
Parity	None	
Target Port No.	<u>0</u> to 223, 255	

PLC

Be sure to match the settings to those made on the [Communication Setting] tab window of the editor.

System Information

Set a station number for the PLC using the PLC software "WINGPC". For more information, refer to the PLC manual issued by the manufacturer.

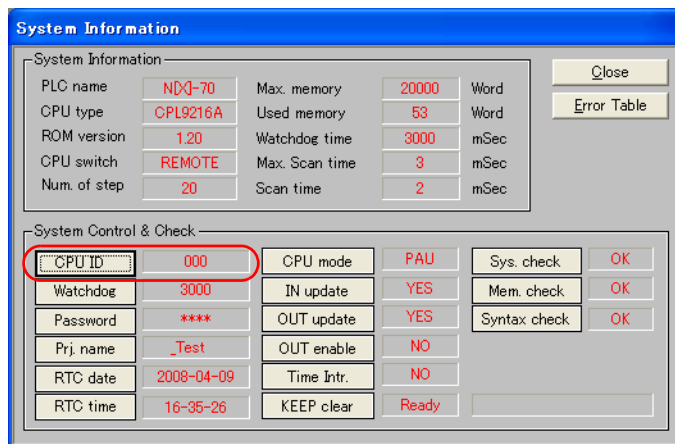

Setting Item	Setting	Remarks
CPU ID	0 to 223, 255	

NX70-CPU70p1 (COM Port)

DIP switches

DIPSW		Contents	Setting		
	SW1	Terminating resistance (for RS-485 connection)	SW1	SW2	Terminating Resistance
	SW2		OFF	OFF	Invalid
			ON	ON	Valid
	SW3	Program write target	ON: EEPROM OFF: RAM		
	SW4	RS-232C / RS-485 selection	ON: RS-485 OFF: RS-232C		
	SW5	Baud rate selection	SW5	SW6	Baud rate
	OFF		OFF	9600bps	
	ON		OFF	38400bps	
	OFF		ON	19200bps	
	ON	ON	4800bps		

NX70-CPU70p2 (COM Port) / NX-CPU700p (COM Port)

DIP switches 1

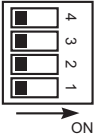
DIPSW1		Contents	Setting		
	SW1	COM1 terminating resistance (for RS-485 connection)	SW1	SW2	Terminating Resistance
	SW2		OFF	OFF	Invalid
			ON	ON	Valid
	SW3	COM2 terminating resistance (for RS-485 connection)	SW3	SW4	Terminating Resistance
SW4	OFF		OFF	Invalid	
		ON	ON	Valid	

DIP switches 2

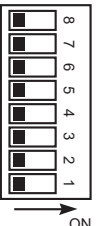
DIPSW2		Contents	Setting		
	SW1	Program write target	ON: EEPROM OFF: RAM		
	SW2	Not used	OFF		
	SW3	RS-232C / RS-485 selection (COM2)	ON: RS-485 OFF: RS-232C		
	SW4	RS-232C / RS-485 selection (COM1)	ON: RS-485 OFF: RS-232C		
	SW5	Baud rate selection (COM1)	SW5	SW6	Baud Rate
			OFF	OFF	9600bps
			ON	OFF	38400bps
			OFF	ON	19200bps
		ON	ON	4800bps	
	SW7	Baud rate selection (COM2)	SW7	SW8	Baud Rate
	OFF		OFF	9600bps	
	ON		OFF	38400bps	
	OFF		ON	19200bps	
	ON	ON	4800bps		

NX-CCU+(CCU) / NX70-CCU+(CCU)

DIP switches

DIPSW		Contents	Setting				
	SW1	Baud rate selection	SW1	SW2	SW3	Baud Rate	
	SW2		OFF	OFF	OFF	38400bps	
	SW3		ON	OFF	OFF	19200bps	
			OFF	ON	OFF	9600bps	
				ON	ON	OFF	4800bps
	SW4	Data length	ON: 8 bits				
	SW5	Parity check	OFF: None				
	SW6						
SW7	Stop bit	OFF: 1 bit					
SW8	Reserved	OFF					

NX7-xxxDx/NX7R-xxADx/NX7S-xxxDx

DIP switches

DIPSW		Contents	Setting
	SW1	RS-232C / RS-485 selection	ON: RS-485 OFF: RS-232C
	SW2	Terminating resistance (with RS-485 selected)	ON: Valid OFF: Invalid

Baud rate setting

The baud rate depends on the value specified for device SR509 or SR510.

COM	Baud Rate	Setting	Remarks
COM1= SR509 COM2= SR510	Auto setting:	0000 H	
	4800 bps	8003 H	
	9600 bps	8000 H	
	19200 bps	8001 H	
	38400 bps	8002 H	
	57600 bps	8004 H	Supported by NX7R only
	115K bps	8005 H	Supported by NX7R only

Available Memory

The available memory setting range varies depending on the PLC model. Be sure to set within the range available for the PLC. Use [TYPE] when assigning the indirect memory for macro programs.

Memory	TYPE	Remarks
R (input/output)	00H	
L (link relay)	01H	
M (internal relay)	02H	
K (keep relay)	03H	
F (special relay)	04H	
W (word register)	05H	
TC (timer, counter)	06H	
SV (timer/set value)	07H	
PV (timer/current value)	08H	
SR (special register)	09H	
D (word register)	0AH	

34.1.2 N7/NX Series (70/700/750/CCU)

Communication Setting

Editor

Communication setting

(Underlined setting: default)

Item	Setting	Remarks
Connection Mode	<u>1 : 1</u> / 1 : n / Multi-link / Multi-link2	
Signal Level	<u>RS-232C</u> / RS-422/485	
Baud Rate	4800 / <u>9600</u> / 19200 / 38400 / 57600 / 76800 / 115K bps	
Data Length	7 / <u>8</u> bits	
Stop Bit	<u>1</u> / 2 bits	
Parity	None / <u>Odd</u> / Even	
Target Port No.	0 to 31	Only port No. 31 is valid, depending on the CPU model. For connection with a CCU module, select port No. 1.
Header	% (<u>Header</u>) / < (Extension Header)	Models on which "< (Expansion Header)" is available: NX-CPU750A / NX-CPU750B / NX-CPU750C / NX-CPU750D / NX70-CPU750
Monitor Registration	Unchecked / <u>Checked</u>	One TS unit can be registered as a monitor for one PLC. When multi-link connection (n : 1) is selected, do not check this box for multiple TS units.

PLC

Be sure to match the settings to those made on the [Communication Setting] tab window of the editor.

Available Memory

The available memory setting range varies depending on the PLC model. Be sure to set within the range available for the PLC. Use [TYPE] when assigning the indirect memory for macro programs.

Memory	TYPE	Remarks
DT (data register)	00H	
X (external input)	01H	WX as word device, read only
Y (external output)	02H	WY as word device
R (internal relay)	03H	WR as word device
L (link relay)	04H	WL as word device
LD (link register)	05H	
FL (file register)	06H	
SV (timer, counter/set value)	07H	
EV (timer, counter/elapsed time)	08H	
T (timer/contact)	09H	Read only
C (counter/contact)	0AH	Read only

34.1.3 X8 Series

Communication Setting

Editor

Communication setting

(Underlined setting: default)

Item	Setting	Remarks
Connection Mode	<u>1</u> : 1 / 1 : n / Multi-link / Multi-link2 / Multi-link2 (Ethernet) / 1 : n Multi-link2 (Ethernet)	
Signal Level	<u>RS-232C</u> / RS-422/485	
Baud Rate	4800 / 9600 / 19200 / 38400 / 57600 / <u>115K</u> bps	
Data Length	<u>8 bits</u>	
Stop Bit	<u>1</u> / 2 bits	
Parity	<u>None</u> / Even	
Target Port No.	0 to 249	

PLC

Make communication settings using the PLC software "XGPC" (version 1.0 or greater). For more information, refer to the PLC manual issued by the manufacturer.

Channel Configuration

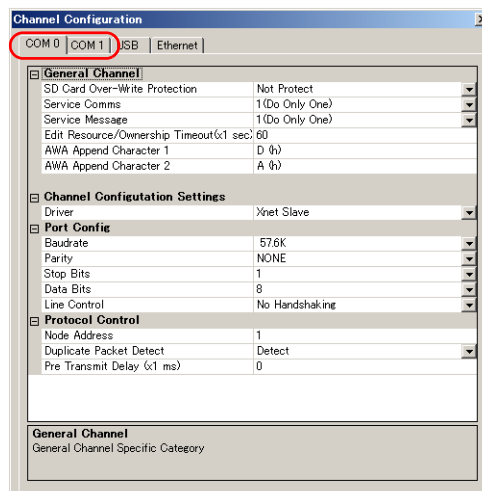

Setting Item	Setting	Remarks
Driver	Xnet Slave	
Baudrate	4.8K / 9.6K / 19.2K / 38.4K / 57.6K / 115.2K	
Parity	NONE / EVEN	
Stop bits	1 / 2	
Data bits	8	
Line Control	No Handshaking / No Handshaking (RS485 Network)	RS-232C connection: No Handshaking RS-485 connection: No Handshaking (RS485 Network)
Node Address	0 to 249	

Available Memory

The available memory setting range varies depending on the PLC model. Be sure to set within the range available for the PLC. Use [TYPE] when assigning the indirect memory for macro programs.

Memory	TYPE	Remarks
N (Integer)	00H	
X (Input)	01H	
Y (Output)	02H	
SR (System Registers)	03H	
B (Binary)	04H	
F (Floating Point)	05H	Real number. Bit designation is not possible.
L (Long)	06H	Double-word
A (ASCII)	07H	
ST (String)	08H	STRING type
TM (Timer)	09H	
CT (Counter)	0AH	
CR (Control)	0BH	

Address denotations

The assigned memory is indicated when editing the screen as shown below.

- Integer, System Registers, Binary, Floating Point, Long, or ASCII addresses

Word designation

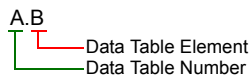

Bit designation

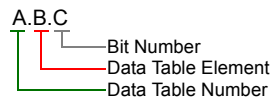

- Input, Output addresses

Word designation

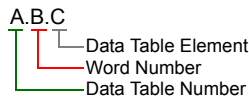

Bit designation

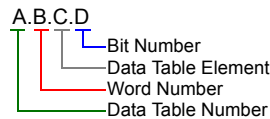

- String, Timer, Counter, or Control addresses

Word designation

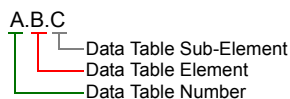

Bit designation

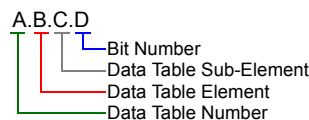

Mnemonics can be used to specify Timer, Counter, or Control addresses.

The following shows the representation using mnemonics:

On PLC	On V-SFT
TimeBase0	TB0
TimeBase1	TB1
Done	DN
TimerTiming	TT
Enable	EN
Underflow	UF
Overflow	OF
CountDown	CD
CountUp	CU
Found	FD
Inhibit	IH

On PLC	On V-SFT
Unload	UL
Error	ER
Empty	EM
EnableUnload	EU
Preset(Low)	PRE(L)
Preset(High)	PRE(H)
Accumulator(Low)	ACC(L)
Accumulator(High)	ACC(H)
Length	LEN
Position	POS

- Mnemonics can be used for bit designation on condition that Data Table Sub-Element = 0.
Example: TM9.0.0.8 → TM9.0.0.TB0
- Mnemonics can be used for memory address designation on condition that Data Table Sub-Element = 1 to 4.
Example: TM9.0.1 → TM9.0.PRE(L)

For more information on using mnemonics, refer to the PLC manual issued by the manufacturer.

Indirect Memory Designation

	15	MSB	8	7	LSB	0
n+0	Model				Memory type	
n+1	Lower address No.					
n+2	Higher address No.					
n+3	00		Bit designation			
n+4	00		Station number			

- Devices other than String, Timer, Counter, and Control

Example: Indirect memory designation of "N20.100"

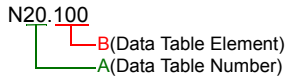

Converting A to binary
20(DEC)= 10100(BIN)

11	10	09	08	07	06	05	04	03	02	01	00
0	0	0	0	0	0	0	1	0	1	0	0

└─ X
└─ Y

Converting B to binary
100(DEC)= 1100100(BIN)

11	10	09	08	07	06	05	04	03	02	01	00
0	0	0	0	0	1	1	0	0	1	0	0

└─ Z

Arranging the values X, Y and Z in the following order

n + 1 (lower address number)

15	14	13	12	11	10	09	08	07	06	05	04	03	02	01	00
0	1	0	1	0	0	0	0	0	1	1	0	0	1	0	0

└─ Y
└─ Z

n + 2 (higher address number)

15	14	13	12	11	10	09	08	07	06	05	04	03	02	01	00
0	0	0	0	0	0	0	0	0	0	0	0	0	0	0	1

└─ 0 fixed
└─ X

0000100100000010 (BIN) = 5064 (HEX): Lower address number
0000000000000001 (BIN) = 1 (HEX): Higher address number

34.1.4 NX700 Series (Ethernet)

Communication Setting

Editor

Make the following settings on the editor. For more information, see Appendix 2 Ethernet.

- IP address for the TS unit
 - When specified on the screen data:
[System Setting] → [Ethernet Communication] → [Local Port IP Address]
 - When specified on the TS unit:
Main Menu screen → [Ethernet]
- Port number for the TS unit (for communication with PLC)
[System Setting] → [Device Connection Setting] → [Communication Setting]
- Others
[System Setting] → [Device Connection Setting] → [Communication Setting]

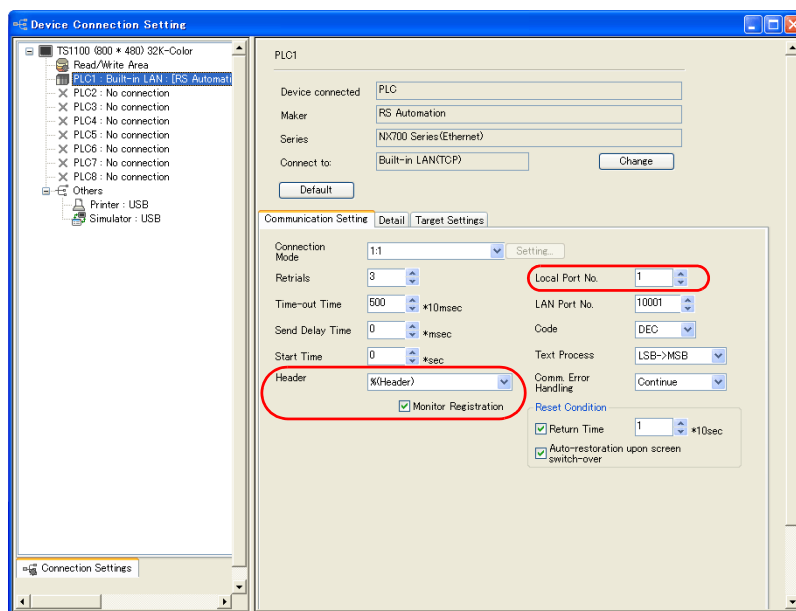

Local Port No.	Set the local port number of the TS unit (1 to 64). Set the same number as the one set for "Target node MEWTOCOL station number" on the [Connection Setting] dialog of the PLC.
Header	Select a format of communication with the PLC. %(Header) / < (Extension Header)
Monitor Registration	Check this box in the case where a monitor registration command is used for communication with the PLC. * One TS unit can be registered as a monitor for one PLC. Do not check this box for multiple TS units in n : 1 connection.

* For settings other than the above, see "1.5.1 PLC1 to PLC8" (page 1-24).

- IP address and port number of the PLC
 [System Setting] → [Device Connection Setting] → [PLC Table]
 Set the same PLC table number as the one for “MEWTOCOL Station Number” ([Initial Information Setting] → [Local Node Setting])

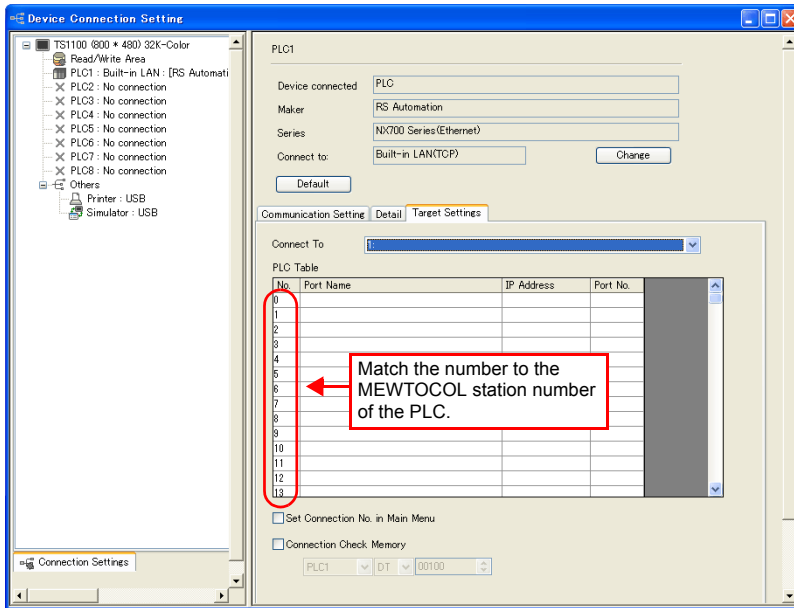

PLC

Make mode settings using the Ethernet unit “NX-Ethernet”.

Mode setting switch

Switch	Setting	Contents	Remarks
2	ON	Auto connection function	

Make the PLC setting using the configuration tool “Configurator ET”. For more information, refer to the PLC manual issued by the manufacturer.

Initial information setting

Item	Setting	
Local Node Setting	IP Address	Set the IP address of the PLC.
	MEWTOCOL Station Number	1 to 64 * The same number must be specified for the PLC table number of the TS.

Connection setting

Item	Setting	
Connection 1 to 8 * Select a port to which the TS is connected.	Communication Mode	TCP/IP, UDP/IP
	Open Type	Unpassive
	Usage	MEWTOCOL communication
	Local Node (PLC) Port Number	As desired
	Target Node IP Address	IP address of the TS
	Target Node Port Number	Port number of the TS
	Target Node MEWTOCOL Station Number	1 to 64 * Match the number to the one set for [Local Port No.] in the [Communication Setting] tab window on the TS.
	Connection Setting	Valid

Available Memory

The available memory setting range varies depending on the PLC model. Be sure to set within the range available for the PLC. Use [TYPE] when assigning the indirect memory for macro programs.

Memory	TYPE	Remarks
DT (data register)	00H	
X (external input)	01H	WX as word device, read only
Y (external output)	02H	WY as word device
R (internal relay)	03H	WR as word device
L (link relay)	04H	WL as word device
LD (link register)	05H	
FL (file register)	06H	
SV (timer, counter/set value)	07H	
EV (timer, counter/elapsed time)	08H	
T (timer/contact)	09H	Read only
C (counter/contact)	0AH	Read only

34.1.5 X8 Series (Ethernet)

Communication Setting

Editor

Make the following settings on the editor. For more information, see Appendix 2 Ethernet.

- IP address for the TS unit
 - When specified on the screen data:
[System Setting] → [Ethernet Communication] → [Local Port IP Address]
 - When specified on the TS unit:
Main Menu screen → [Ethernet]
- Port number for the TS unit (for communication with PLC)
[System Setting] → [Device Connection Setting] → [Communication Setting]

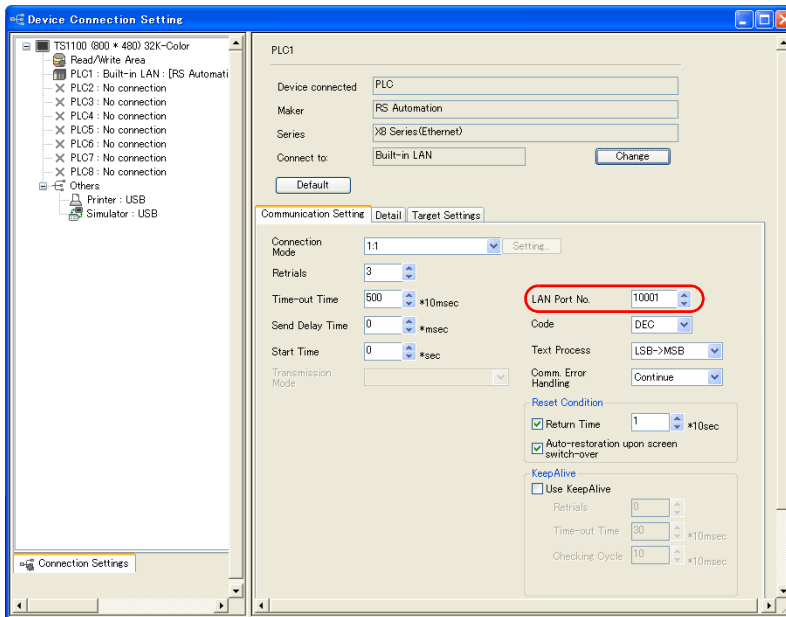

- IP address and port number (No. 50000) for the PLC
[System Setting] → [Device Connection Setting] → [PLC Table]

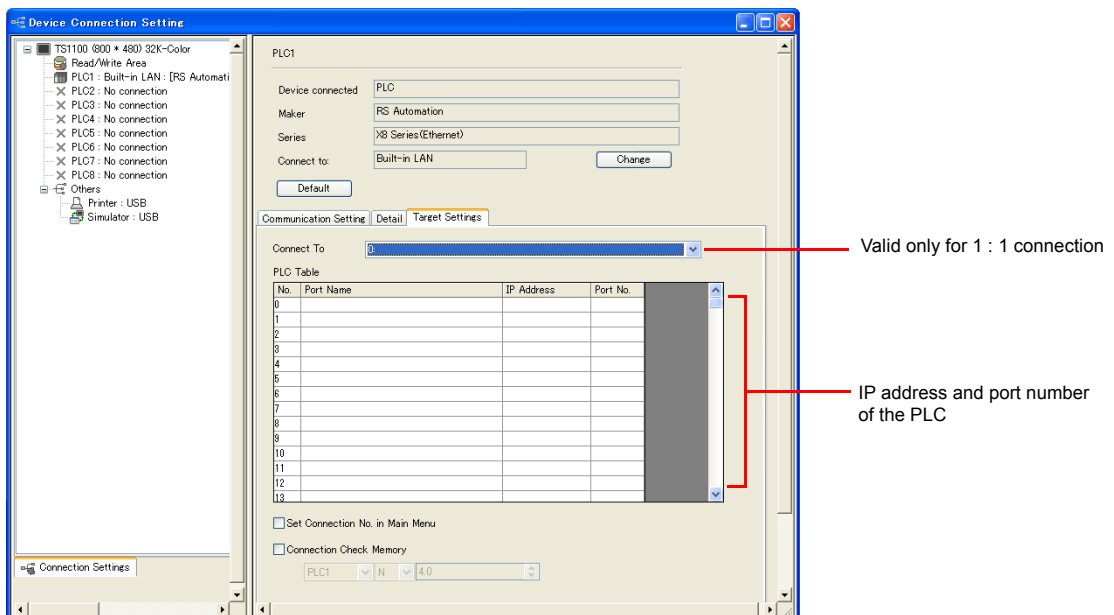

PLC

Set a station number for the PLC using the PLC software “XGPC” (version 1.0 or greater). For more information, refer to the PLC manual issued by the manufacturer.

Channel Configuration

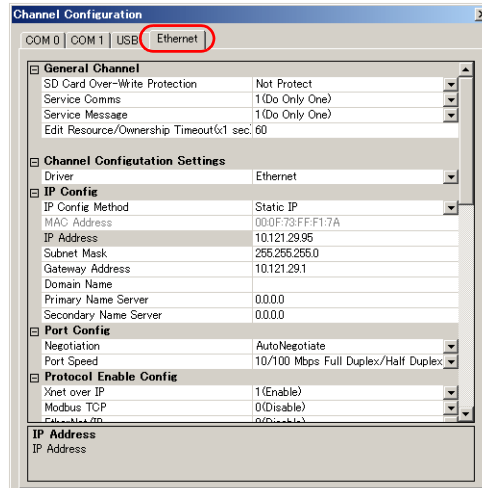

Setting Item	Setting	Remarks
IP Address	Set the IP address of the PLC.	
Subnet Mask	Set the subnet mask of the PLC.	
Gateway Address	Set according to the environment.	

Available Memory

The contents of “Available Memory” are the same as those described in “34.1.3 X8 Series”.

34.1.6 Wiring Diagrams

When Connected at COM1:

RS-422/RS-485

Wiring diagram 1 - COM1

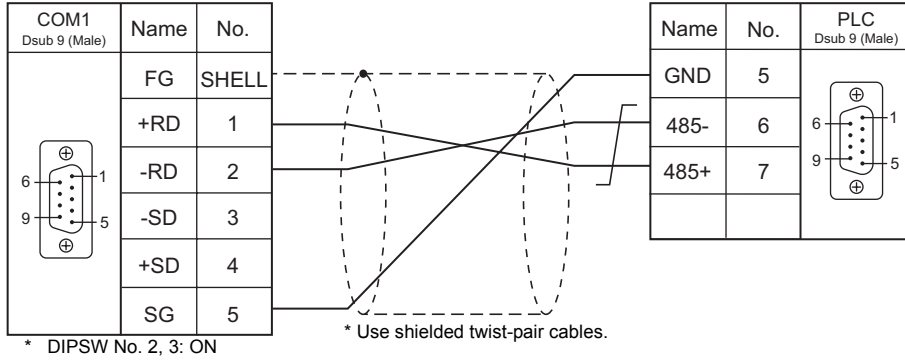

Wiring diagram 2 - COM1

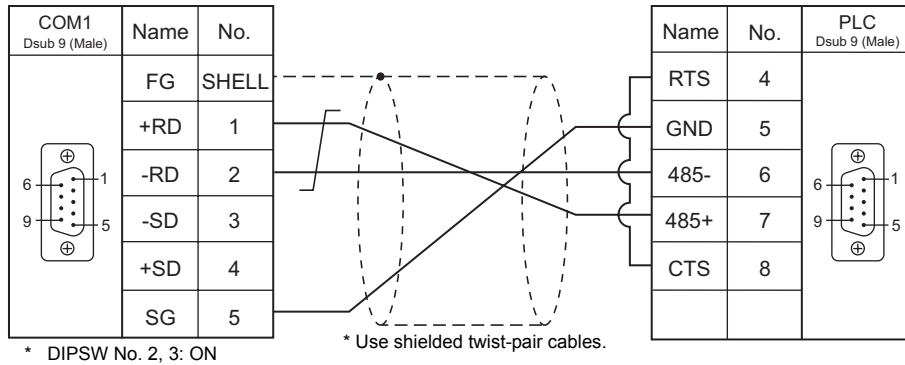

Wiring diagram 3 - COM1

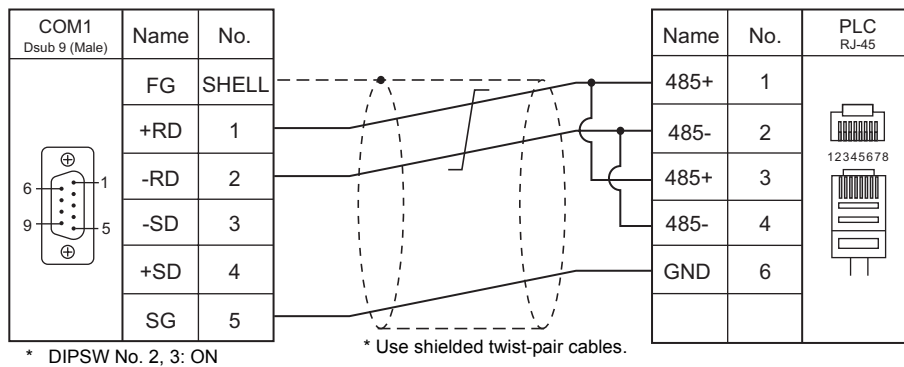

Wiring diagram 4 - COM1

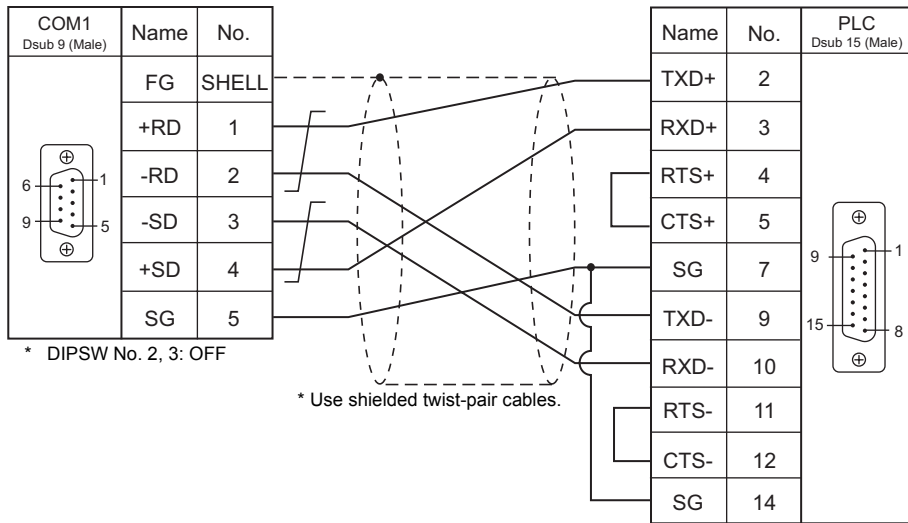

Wiring diagram 5 - COM1

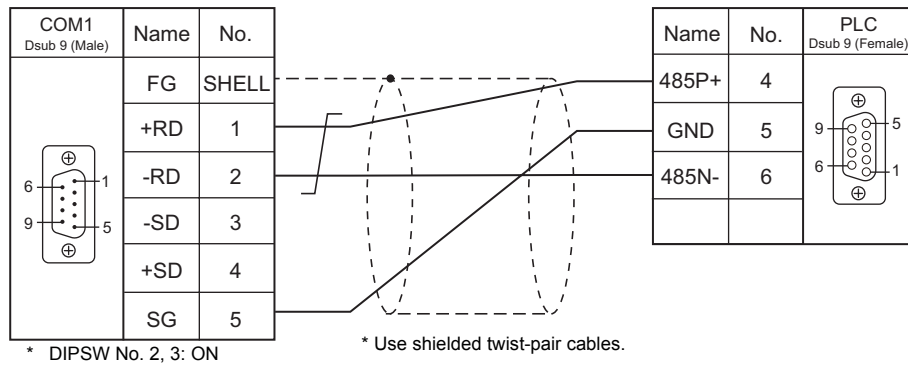

When Connected at COM2:

RS-232C

Wiring diagram 1 - COM2

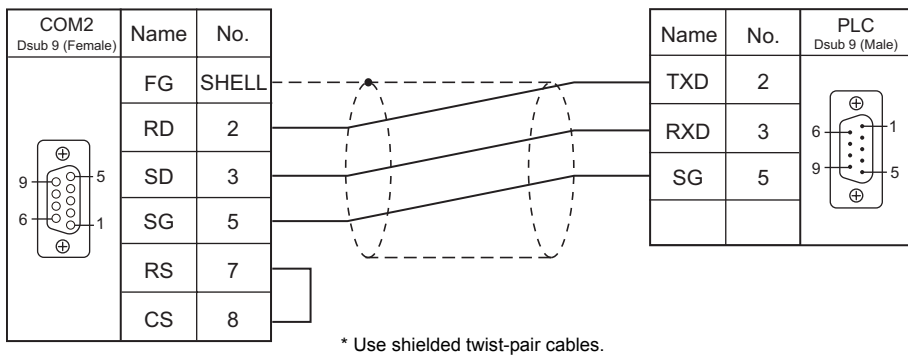

Wiring diagram 2 - COM2

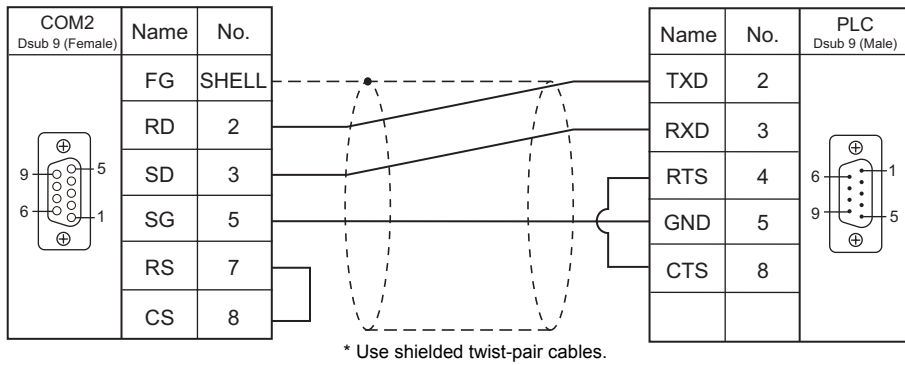

Wiring diagram 3 - COM2

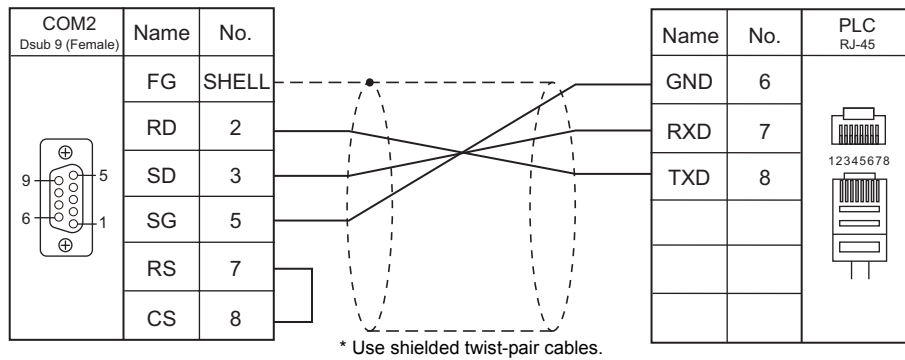

Wiring diagram 4 - COM2

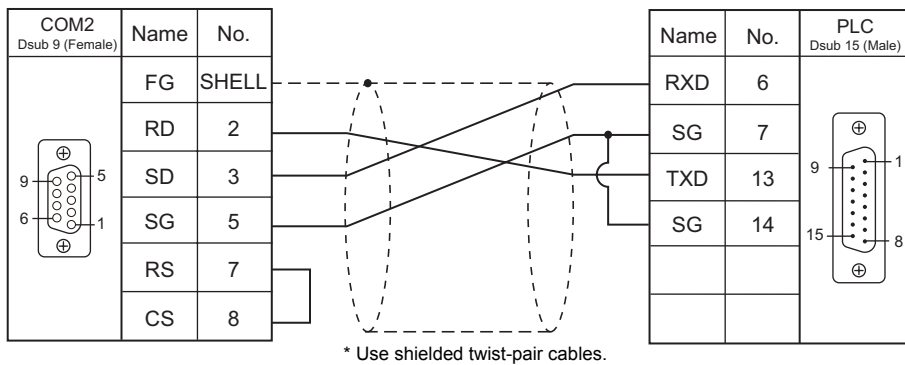

Wiring diagram 5 - COM2

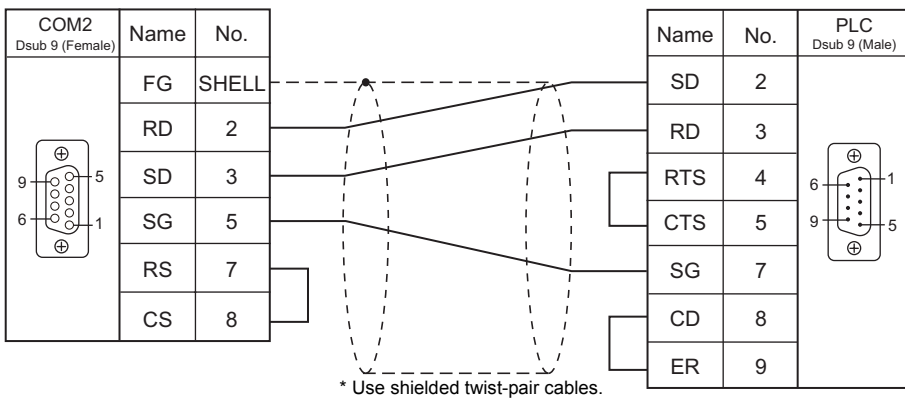

Wiring diagram 6 - COM2

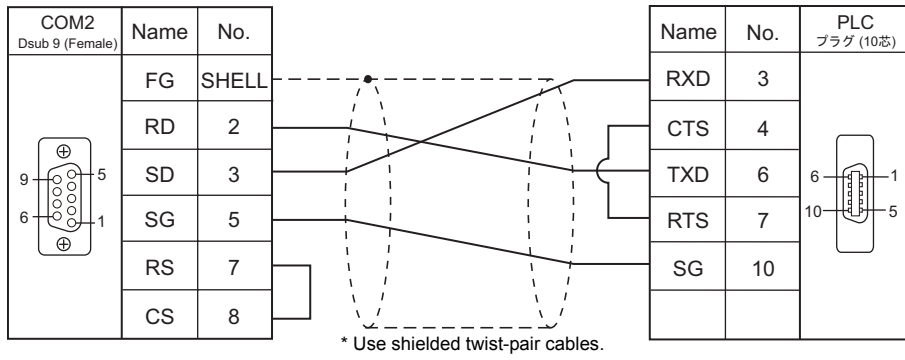

Wiring diagram 7 - COM2

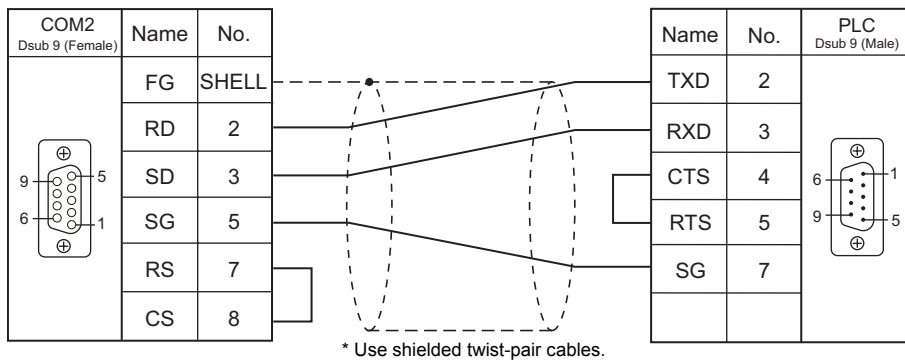

Wiring diagram 8 - COM2

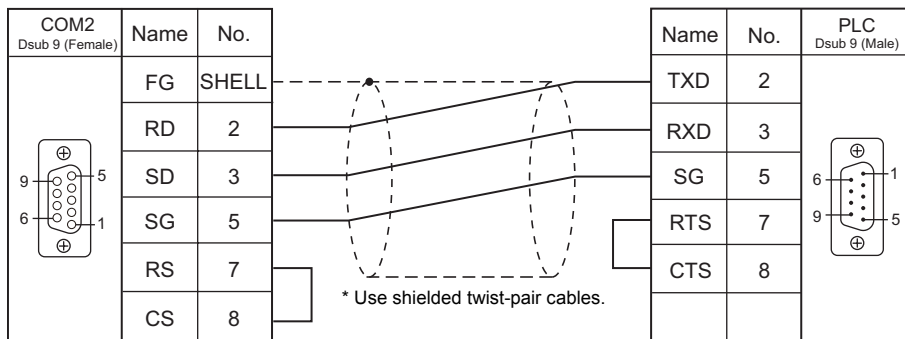

Wiring diagram 9 - COM2

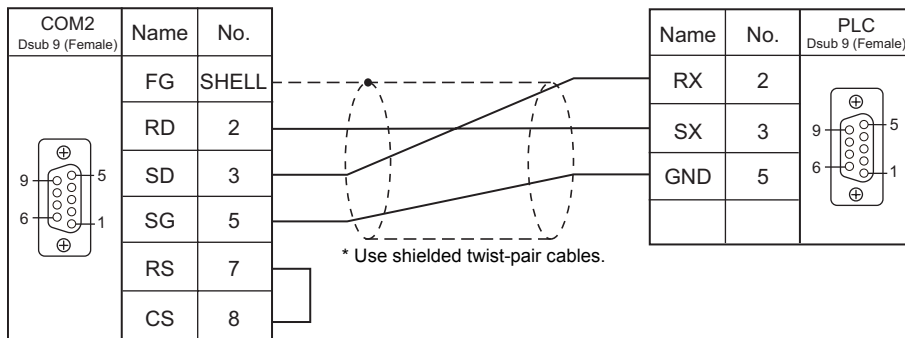

When Connected at COM3:

RS-485

Wiring diagram 1 - COM3

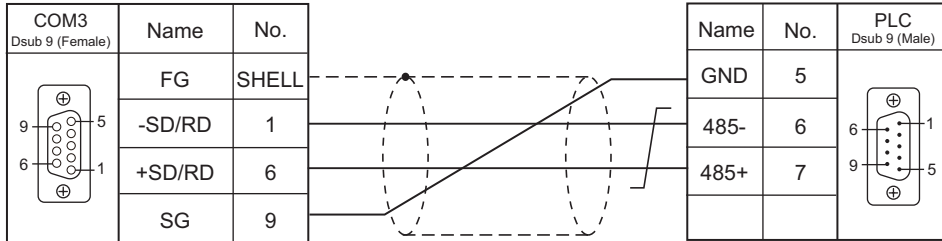

Wiring diagram 2 - COM3

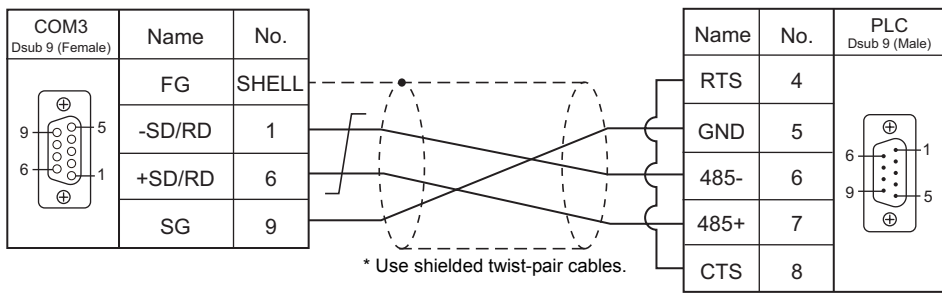

Wiring diagram 3 - COM3

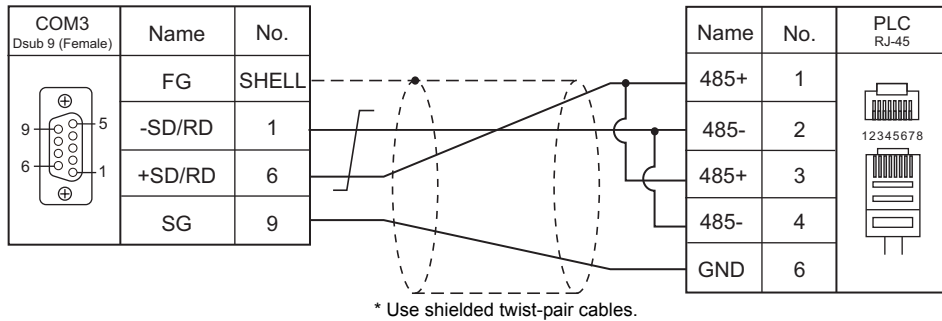

Wiring diagram 4 - COM3

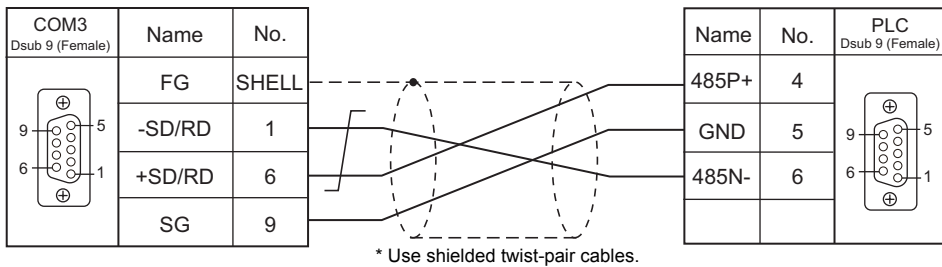

35. SAIA

35.1 PLC Connection

35.1 PLC Connection

Serial Connection

PLC Selection on the Editor	CPU	Unit/Port	Signal Level	TS Port	Connection	Ladder Transfer ^{*1}
PCD	PCD1.M120 PCD1.M130 PCD2.M120 PCD2.M130 PCD2.M170 PCD2.M480	PGU port	RS-232C	COM2	Wiring diagram 1 - COM2	×
		PCD7.F120	RS-232C	COM2	Wiring diagram 2 - COM2	
		PCD7.F110	RS-485	COM1	Wiring diagram 1 - COM1	
				COM3	Wiring diagram 1 - COM3	

*1 For the ladder transfer function, see "Appendix 5 Ladder Transfer Function".

Ethernet Connection

PLC Selection on the Editor	CPU	Unit	TCP/IP	UDP/IP	Port No.	Ladder Transfer ^{*1}
PCD S-BUS (Ethernet)	PCD.M3120 PCD.M3330 PCD.M5340 PCD.M5540 PCD.M6340 PCD.M6540	CPU with built-in Ethernet	×	○	5050 fixed	×

*1 For the ladder transfer function, see "Appendix 5 Ladder Transfer Function".

35.1.1 PCD

Communication Setting

Editor

Communication setting

(Underlined setting: default)

Item	Setting	Remarks
Connection Mode	<u>1</u> : 1 / 1 : n / Multi-link2	
Signal Level	<u>RS-232C</u> / RS-422/485	
Baud Rate	9600 / <u>19200</u> / 38400 / 57600 / 115K bps	
Data Length	8 bits	
Stop Bit	1 bits	
Target Port No.	1	

PLC

PCD

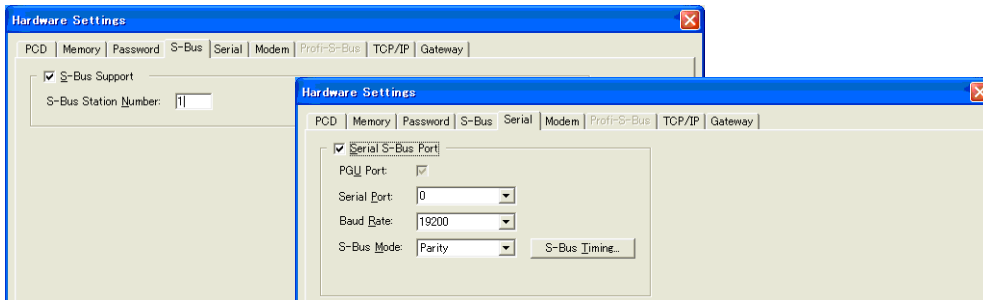

Item	Setting	Remarks
S-Bus Station Number	1	
Serial Port	0: PGU Port 1: PCD7.F120 / F110	
Baud Rate	19200 bps	
S-Bus Mode	Parity	

Available Memory

The available memory setting range varies depending on the PLC model. Be sure to set within the range available with the PLC to be used. Use [TYPE] when assigning the indirect memory for macro programs.

Memory	TYPE	Remarks
R (register)	00H	Double-word
Rfp (register/floating point)	01H	Double-word
T (timer)	02H	Double-word
C (counter)	03H	Double-word
I (input)	04H	Read only
O (output)	05H	
F (flag)	06H	

35.1.2 PCD S-BUS (Ethernet)

Communication Setting

Editor

Make the following settings on the editor. For more information, see “Appendix 2 Ethernet”.

- IP address for the TS unit
- TS unit's port number in the [Communication Setting] tab window ([System Setting] → [Device Connection Setting])
- PLC's IP address and port number for [PLC Table] in the [Target Settings] tab window ([System Setting] → [Device Connection Setting] → [Target Settings])

PLC

PCD S-BUS (Ethernet)

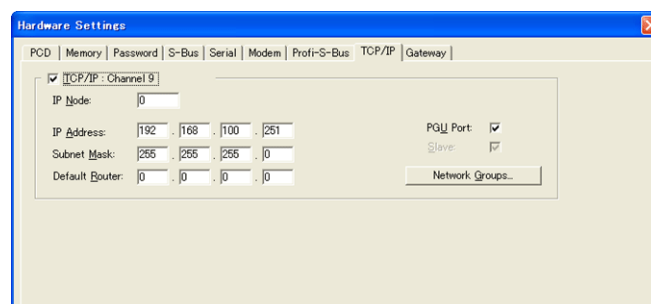

Item	Setting	Remarks
IP Node	Make settings in accordance with the network environment.	For more information, refer to the manual of the PLC.
IP Address	PLC's IP address	
Subnet Mask	PLC's subnet mask	
Default Router	Make settings in accordance with the network environment.	

Available Memory

The available memory setting range varies depending on the PLC model. Be sure to set within the range available with the PLC to be used. Use [TYPE] when assigning the indirect memory for macro programs.

Memory	TYPE	Remarks
R (register)	00H	Double-word
Rfp (register/floating point)	01H	Double-word
T (timer)	02H	Double-word
C (counter)	03H	Double-word
I (input)	04H	Read only
O (output)	05H	
F (flag)	06H	

35.1.3 Wiring Diagrams

When Connected at COM1:

RS-485

Wiring diagram 1 - COM1

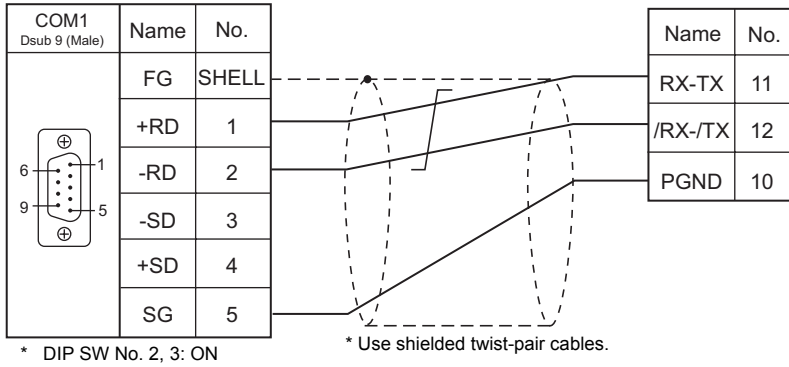

When Connected at COM2:

RS-232C

Wiring diagram 1 - COM2

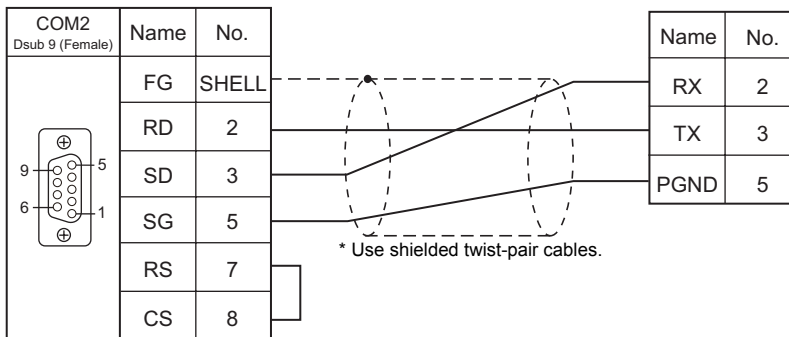

Wiring diagram 2 - COM2

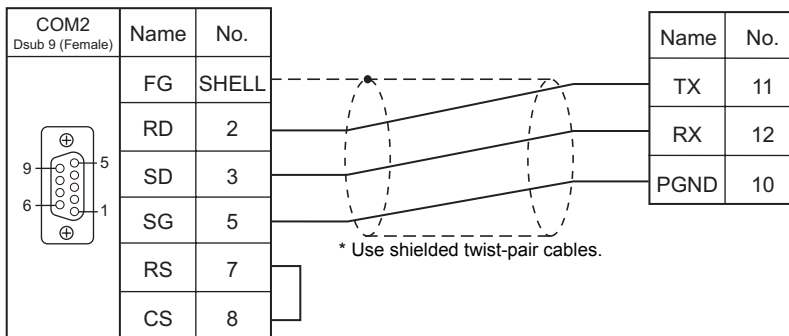

When Connected at COM3:

RS-485

Wiring diagram 1 - COM3

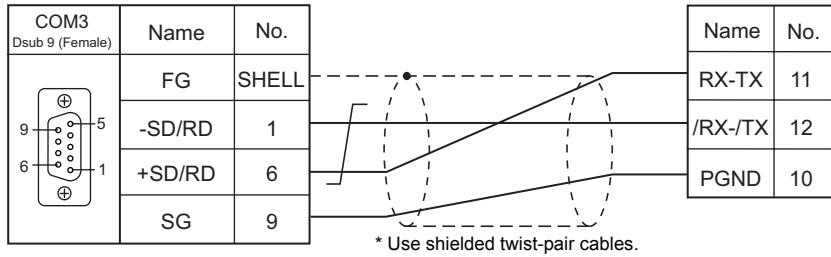

MEMO

Please use this page freely.

36. SAMSUNG

36.1 PLC Connection

36.1 PLC Connection

Serial Connection

PLC Selection on the Editor	CPU		Unit/Port	Signal Level	TS Port	Connection	Ladder Transfer ^{*1}
N_plus	N70 plus	CPL9215A CPL9216A	COM1/COM2	RS-232C	COM2	Wiring diagram 1 - COM2	×
				RS-485	COM1	Wiring diagram 1 - COM1	
	N700 plus	CPL7215A	COM1/COM2		RS-485	COM3	
				COM port	NX70-CPU70p1	RS-232C	
	RS-485	COM1	Wiring diagram 1 - COM1				
		COM3	Wiring diagram 1 - COM3				
		NX70-CCU+(CCU)	RS-232C			COM2	
	RS-485		COM1			Wiring diagram 1 - COM1	
			COM3			Wiring diagram 1 - COM3	
	NX70 plus	NX70-CPU70p2	COM1/COM2	RS-232C	COM2	Wiring diagram 1 - COM2	
				RS-485	COM1	Wiring diagram 1 - COM1	
					COM3	Wiring diagram 1 - COM3	
			NX70-CCU+(CCU)	RS-232C	COM2	Wiring diagram 1 - COM2	
				RS-485	COM1	Wiring diagram 1 - COM1	
					COM3	Wiring diagram 1 - COM3	
	NX700 plus	NX-CPU700p	COM1/COM2	RS-232C	COM2	Wiring diagram 1 - COM2	
				RS-485	COM1	Wiring diagram 1 - COM1	
					COM3	Wiring diagram 1 - COM3	
NX-CCU+(CCU)			RS-232C	COM2	Wiring diagram 1 - COM2		
			RS-485	COM1	Wiring diagram 1 - COM1		
				COM3	Wiring diagram 1 - COM3		
SECTNET	N70	CPL9211A	COM port	RS-232C	COM2	Wiring diagram 2 - COM2	
				RS-422	COM1	Wiring diagram 2 - COM1	
	N70α	CPL9210A	COM port	RS-232C	COM2	Wiring diagram 4 - COM2	
					COM2	Wiring diagram 3 - COM2	
	N700	CPL7210A CPL7211A	COM port	RS-232C	COM2	Wiring diagram 2 - COM2	
				RS-422	COM1	Wiring diagram 2 - COM1	
			CPL7462(CCU)	RS-232C	COM2	Wiring diagram 3 - COM2	
	N700α	CPL6210A CPL6210B	TOOL port	RS-232C	COM2	Wiring diagram 3 - COM2	
			COM port		COM2	Wiring diagram 5 - COM2	
			CPL7462(CCU)		COM2	Wiring diagram 3 - COM2	
	N7000	CPL5221B CPL5231	COM port	RS-232C	COM2	Wiring diagram 2 - COM2	
				RS-422	COM1	Wiring diagram 2 - COM1	
	N7000α	CPL4210 CPL4211	COM1	RS-232C	COM1	Wiring diagram 2 - COM1	
			COM2		COM2	Wiring diagram 5 - COM2	
			CPL5462(CCU)		COM2	Wiring diagram 3 - COM2	
	NX70	NX70-CPU70	TOOL port	RS-232C	COM2	Wiring diagram 1 - COM2	
			NX70-CCU(CCU)		COM2	Wiring diagram 6 - COM2	
		NX70-CPU750	TOOL port	RS-232C	COM2	Wiring diagram 1 - COM2	
			COM port		COM2	Wiring diagram 6 - COM2	
	NX700	NX-CPU750A NX-CPU750B NX-CPU750C NX-CPU750D	TOOL port	RS-232C	COM2	Wiring diagram 1 - COM2	
			COM port		COM2	Wiring diagram 6 - COM2	
			NX-CCU(CCU)		COM2	Wiring diagram 6 - COM2	
		NX-CPU700	TOOL port	RS-232C	COM2	Wiring diagram 1 - COM2	
			NX-CCU(CCU)		COM2	Wiring diagram 6 - COM2	

*1 For the ladder transfer function, see "Appendix 5 Ladder Transfer Function".

36.1.1 N_plus

Communication Setting

Editor

Communication setting

(Underlined setting: default)

Item	Setting	Remarks
Connection Mode	<u>1</u> : 1 / 1 : n / Multi-link / Multi-link2 / Multi-link2 (Ethernet) / 1 : n Multi-link2 (Ethernet)	
Signal Level	<u>RS-232C</u> / RS-422/485	For RS-485 connection, set the transmission delay time to 3 msec or longer.
Baud Rate	4800 / <u>9600</u> / 19200 / 38400 bps	
Data Length	<u>8 bits</u>	
Stop Bit	<u>1 bit</u>	
Parity	<u>None</u>	
Target Port No.	<u>0</u> to 31	

PLC

Be sure to match the settings to those made on the [Communication Setting] tab window of the editor.

System Information

Set a station number for the PLC using the PLC software "WINGPC". For more information, refer to the PLC manual issued by the manufacturer.

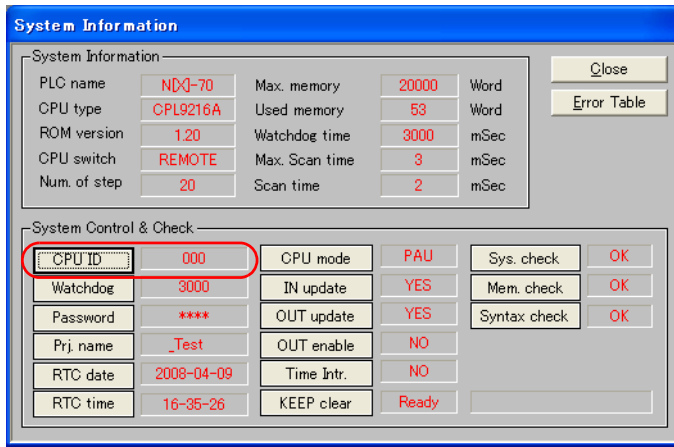

Setting Item	Setting	Remarks
CPU ID	0 to 223, 255	

CPL9215A

DIP switches 1

DIPSW1	Contents	Setting																
	SW1	Program write target ON: EEPROM OFF: RAM																
	SW2	RS-232C / RS-485 selection ON: RS-485 OFF: RS-232C																
	SW3	Baud rate selection	<table border="1"> <thead> <tr> <th>SW3</th> <th>SW4</th> <th>Baud Rate</th> </tr> </thead> <tbody> <tr> <td>OFF</td> <td>OFF</td> <td>9600bps</td> </tr> <tr> <td>ON</td> <td>OFF</td> <td>38400bps</td> </tr> <tr> <td>OFF</td> <td>ON</td> <td>19200bps</td> </tr> <tr> <td>ON</td> <td>ON</td> <td>4800bps</td> </tr> </tbody> </table>	SW3	SW4	Baud Rate	OFF	OFF	9600bps	ON	OFF	38400bps	OFF	ON	19200bps	ON	ON	4800bps
			SW3	SW4	Baud Rate													
OFF	OFF	9600bps																
ON	OFF	38400bps																
OFF	ON	19200bps																
ON	ON	4800bps																
SW4																		

CPL9216A

DIP switches 1

DIPSW1		Contents	Setting		
	SW1	Baud rate selection (COM1)	SW1	SW2	Baud Rate
	SW2		OFF	OFF	9600bps
			ON	OFF	19200bps
			OFF	ON	38400bps
		ON	ON	4800bps	
	SW3	Baud rate selection (COM2)	SW3	SW4	Baud Rate
	SW4		OFF	OFF	9600bps
			ON	OFF	19200bps
OFF			ON	38400bps	
ON		ON	4800bps		
SW5	RS-232C / RS-485 selection (COM1)	ON: RS-485 OFF: RS-232C			
SW6	RS-232C / RS-485 selection (COM2)	ON: RS-485 OFF: RS-232C			
SW7	Not used	OFF			
SW8	Program write target	ON: EEPROM OFF: RAM			

DIP switches 2

DIPSW2		Contents	Setting		
	SW1	COM1 terminating resistance (for RS-485 connection)	SW1	SW2	Terminating Resistance
	SW2		OFF	OFF	Invalid
		ON	ON	Valid	
	SW3	COM2 terminating resistance (for RS-485 connection)	SW3	SW4	Terminating Resistance
SW4	OFF		OFF	Invalid	
	ON	ON	Valid		

CPL7215A

DIP switches 1

DIPSW1		Contents	Setting		
	SW1	Baud rate selection (COM1)	ON: 19200bps OFF: 9600bps		
	SW2	Baud rate selection (COM2)	SW2	SW3	Baud Rate
			OFF	OFF	9600bps
			ON	OFF	19200bps
			OFF	ON	38400bps
	ON	ON	4800bps		
SW4	Program write target	ON: EEPROM OFF: RAM			
SW5	COM2 terminating resistance (for RS-485 connection)	SW5	SW6	Terminating Resistance	
SW6		OFF	OFF	Invalid	
	ON	ON	Valid		

NX70-CPU70p1 (COM Port)

DIP switches

DIPSW		Contents	Setting		
	SW1	Terminating resistance (for RS-485 connection)	SW1	SW2	Terminating Resistance
	SW2		OFF	OFF	Invalid
			ON	ON	Valid
	SW3	Program write target	ON: EEPROM OFF: RAM		
	SW4	RS-232C / RS-485 selection	ON: RS-485 OFF: RS-232C		
	SW5	Baud rate selection	SW5	SW6	Baud Rate
	OFF		OFF	9600bps	
	ON		OFF	38400bps	
	OFF		ON	19200bps	
	SW6		ON	ON	4800bps

NX70-CPU70p2 (COM Port) / NX-CPU700p (COM Port)

DIP switches 1

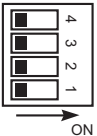
DIPSW1		Contents	Setting		
	SW1	COM1 terminating resistance (for RS-485 connection)	SW1	SW2	Terminating Resistance
	SW2		OFF	OFF	Invalid
			ON	ON	Valid
	SW3	COM2 terminating resistance (for RS-485 connection)	SW3	SW4	Terminating Resistance
SW4	OFF		OFF	Invalid	
		ON	ON	Valid	

DIP switches 2

DIPSW2		Contents	Setting		
	SW1	Program write target	ON: EEPROM OFF: RAM		
	SW2	Not used	OFF		
	SW3	RS-232C / RS-485 selection (COM2)	ON: RS-485 OFF: RS-232C		
	SW4	RS-232C / RS-485 selection (COM1)	ON: RS-485 OFF: RS-232C		
	SW5	Baud rate selection (COM1)	SW5	SW6	Baud Rate
			OFF	OFF	9600bps
			ON	OFF	38400bps
			OFF	ON	19200bps
	SW6		ON	ON	4800bps
SW7	Baud rate selection (COM2)	SW7	SW8	Baud Rate	
		OFF	OFF	9600bps	
		ON	OFF	38400bps	
		OFF	ON	19200bps	
	SW8		ON	ON	4800bps

NX-CCU+(CCU) / NX70-CCU+(CCU)**DIP switches**

DIPSW		Contents	Setting				
	SW1	Baud rate selection	SW1	SW2	SW3	Baud Rate	
	SW2		OFF	OFF	OFF	38400bps	
	SW3		ON	OFF	OFF	19200bps	
			OFF	ON	OFF	9600bps	
				ON	ON	OFF	4800bps
	SW4	Data length	ON: 8 bits				
	SW5	Parity check	OFF: None				
	SW6						
SW7	Stop bit	OFF: 1 bit					
SW8	Reserved	OFF					

Available Memory

The available memory setting range varies depending on the PLC model. Be sure to set within the range available for the PLC. Use [TYPE] when assigning the indirect memory for macro programs.

Memory	TYPE	Remarks
R (input/output)	00H	
L (link relay)	01H	
M (internal relay)	02H	
K (keep relay)	03H	
F (special relay)	04H	
W (word register)	05H	

36.1.2 SECRET

Communication Setting

Editor

Communication setting

(Underlined setting: default)

Item	Setting	Remarks
Connection Mode	<u>1 : 1</u> / 1 : n / Multi-link / Multi-link2	
Signal Level	<u>RS-232C</u> / RS-422/485	
Baud Rate	4800 / <u>9600</u> / 19200 / 38400 / 57600 / 76800 / 115K bps	
Data Length	7 / <u>8</u> bits	
Stop Bit	<u>1</u> / 2 bits	
Parity	None / <u>Odd</u> / Even	
Target Port No.	0 to 31	Only port No. 31 is valid, depending on the CPU model. For connection with a CCU module, select port No. 1.
Header	<u>% (Header)</u> / < (Extension Header)	Models on which "< (Expansion Header)" is available: NX-CPU750A / NX-CPU750B / NX-CPU750C / NX-CPU750D / NX70-CPU750
Monitor Registration	Unchecked / <u>Checked</u>	One TS unit can be registered as a monitor for one PLC. When multi-link connection (n : 1) is selected, do not check this box for multiple TS units.

PLC

Be sure to match the settings to those made on the [Communication Setting] tab window of the editor.

Available Memory

The available memory setting range varies depending on the PLC model. Be sure to set within the range available for the PLC. Use [TYPE] when assigning the indirect memory for macro programs.

Memory	TYPE	Remarks
DT (data register)	00H	
X (external input)	01H	WX as word device, read only
Y (external output)	02H	WY as word device
R (internal relay)	03H	WR as word device
L (link relay)	04H	WL as word device
LD (link register)	05H	
FL (file register)	06H	
SV (timer, counter/set value)	07H	
EV (timer, counter/elapsed time)	08H	
T (timer/contact)	09H	Read only
C (counter/contact)	0AH	Read only

36.1.3 Wiring Diagrams

When Connected at COM1:

RS-422/RS-485

Wiring diagram 1 - COM1

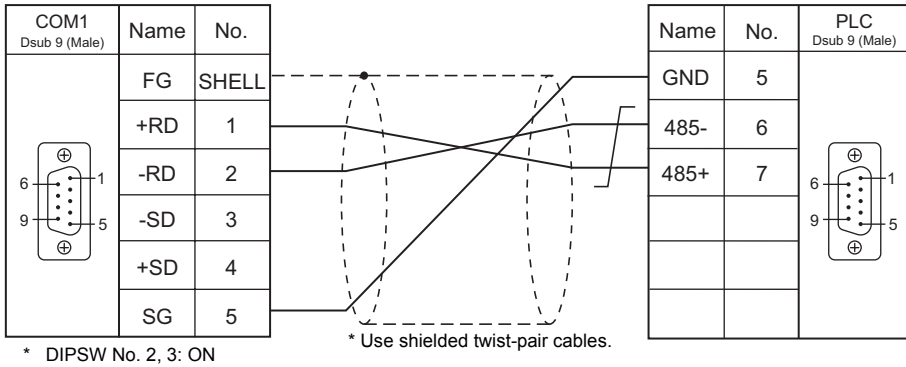

Wiring diagram 2 - COM1

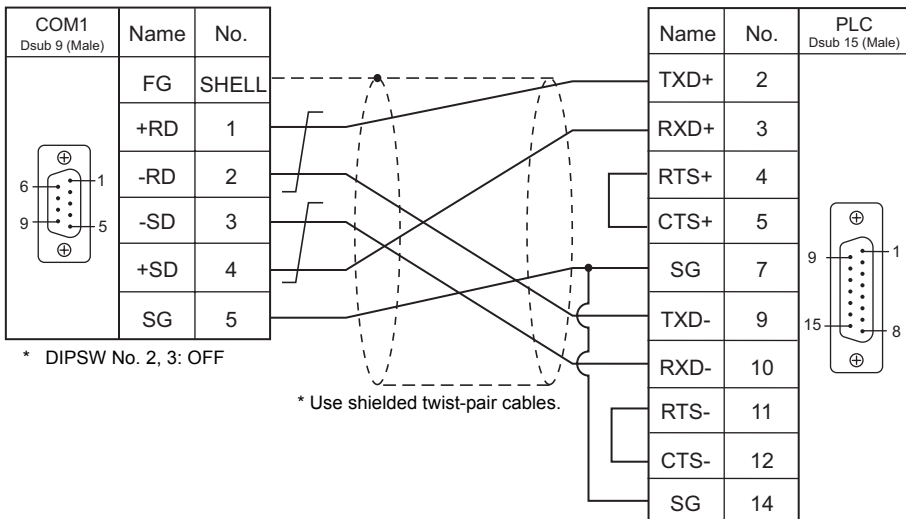

When Connected at COM2:

RS-232C

Wiring diagram 1 - COM2

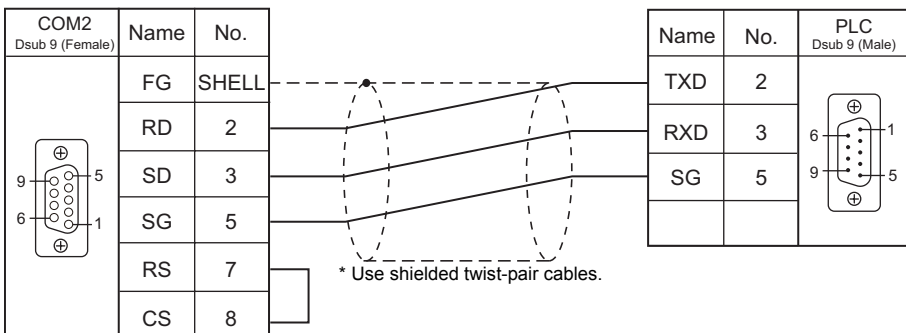

Wiring diagram 2 - COM2

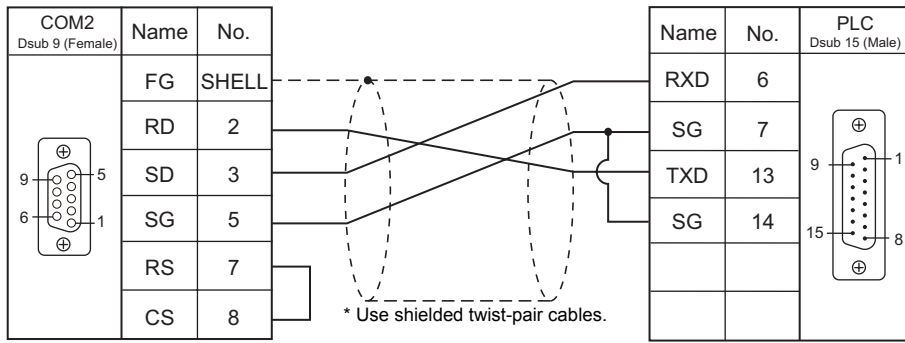

Wiring diagram 3 - COM2

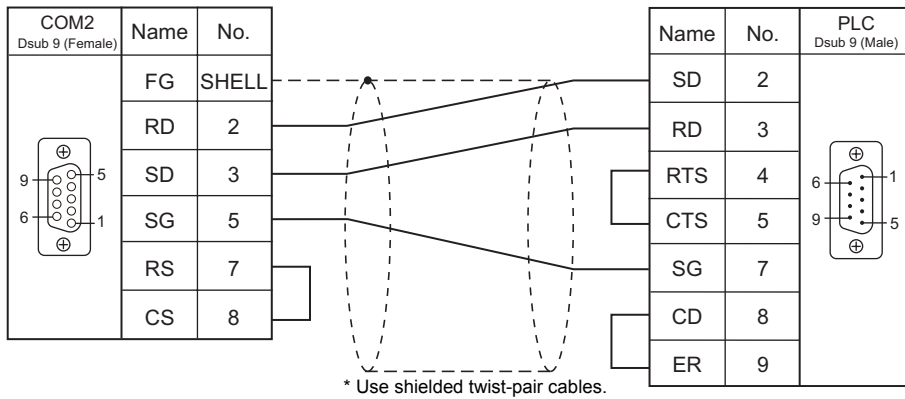

Wiring diagram 4 - COM2

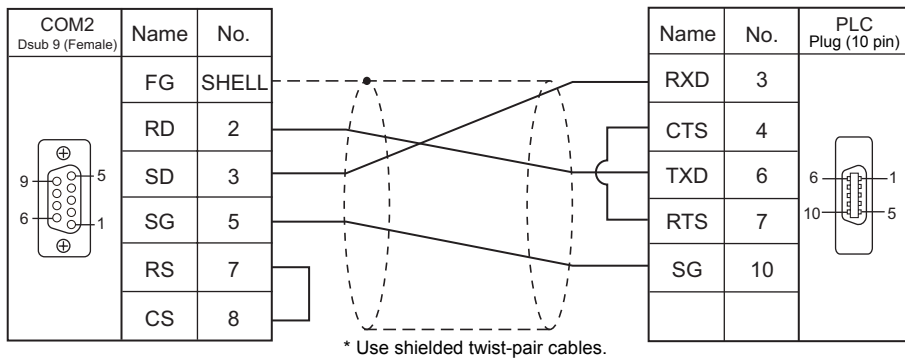

Wiring diagram 5 - COM2

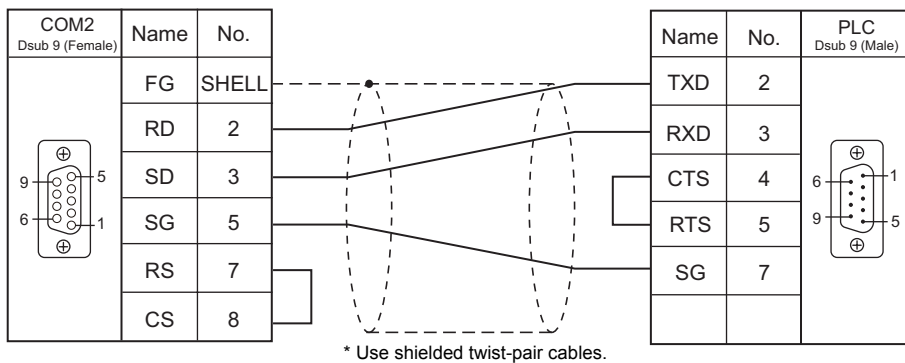

Wiring diagram 6 - COM2

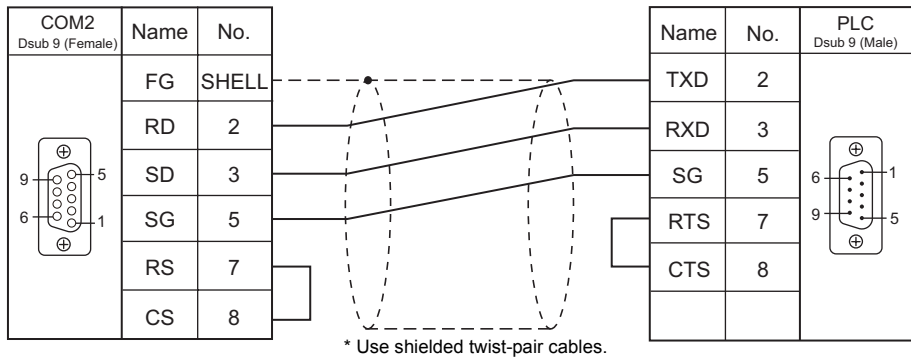

When Connected at COM3:

RS-485

Wiring diagram 1 - COM3

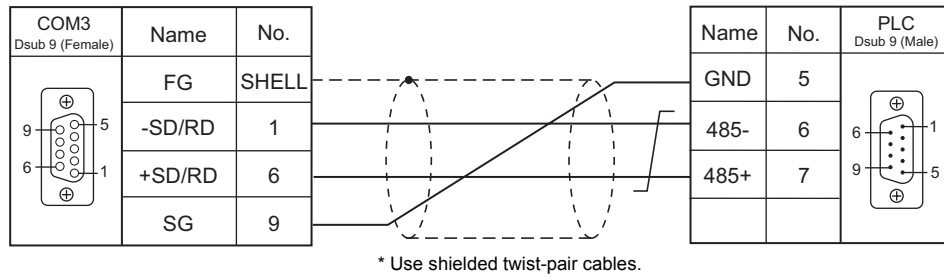

MEMO

Please use this page freely.

37. SanRex

37.1 Temperature Controller / Servo / Inverter Connection

37.1 Temperature Controller / Servo / Inverter Connection

Serial Connection

DC Power Supply Unit

PLC Selection on the Editor	Model	Port	Signal Level	TS Port	Connection	Lst File
DC AUTO (HKD type)	Type HKD B	Terminal block	RS-422	COM1	Wiring diagram 1 - COM1	HKD.Lst

37.1.1 DC AUTO (HKD type)

Communication Setting

Editor

Communication setting

(Underlined setting: default)

Item	Setting	Remarks
Connection Mode	1 : 1 / <u>1:n</u> / Multi-link2	
Signal Level	RS-422/485	
Baud Rate	9600 bps	
Parity	Even	
Data Length	8 bits	
Stop Bit	1 bit	
Target Port No.	<u>1</u> to 31	

DC AUTO (Type HKD B)

Item	Setting	Remarks
Communication address	1 to 31	
Baud rate	9600 BPS	
Transmission mode	8E1	
REMOTE/PANEL key	REMOTE	Remote control mode ^{*1}

^{*1} This setting is not provided, depending on the model.

Available Memory

The available memory setting range varies depending on the device. Be sure to set within the range available with the device to be used.

Use [TYPE] when assigning the indirect memory for macro programs.

Memory	TYPE	Remarks
M (monitor data)	00H	Read only
MD (monitor data (4 bytes))	01H	Double-word, read only
S (setting data)	02H	^{*1}
SD (setting data (4 bytes))	03H	Double-word

^{*1} When changing the data setting, press the REMOTE/PANEL key to select the remote mode.

37.1.2 Wiring Diagrams

When Connected at COM1:

RS-422

Wiring diagram 1 - COM1

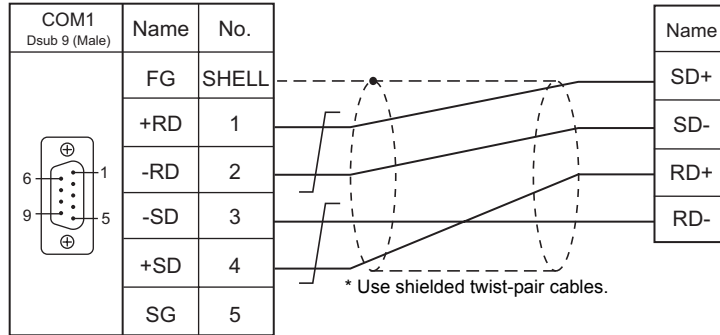

* DIPSW No. 2, 3: OFF

MEMO

Please use this page freely.

38. SANMEI

38.1 Temperature Controller/Servo/Inverter Connection

38.1 Temperature Controller/Servo/Inverter Connection

The controller models shown below can be connected.

AC Servo Driver

PLC Selection on the Editor	Model	Port	Signal Level	TS Port	Connection	Lst File
Cuty Axis	QT-0xxAX	CN4	RS-232C	COM2	Wiring diagram 1 - COM2	SanQT.Lst
			RS-422	COM1	Wiring diagram 1 - COM1	

38.1.1 Cuty Axis

Communication Setting

Editor

Communication setting

(Underlined setting: default)

Item	Setting	Remarks
Connection Mode	1 : 1 / <u>1:n</u> / Multi-link2 / Multi-link2 (Ethernet) / 1 : n Multi-link2 (Ethernet)	
Signal Level	<u>RS-232C</u> / RS-422/485	
Baud Rate	9600 bps (fixed)	
Data Length	8 bits (fixed)	
Stop Bit	1 bit (fixed)	
Parity	Even (fixed)	
Target Port No.	<u>0</u> to 9	Set the same number as the axis number of the AC servo driver.

AC Servo Driver

The communication parameters can be set using the MODE key on the built-in digital operator attached to the front of the AC servo driver.

They can also be set by using the software "Cuty Wave" or the ladder program.

For settings using the software or ladder program, refer to the AC servo driver manual issued by the manufacturer.

(Underlined setting: default)

Mode	Parameter No.	Item	Setting	Remarks
Parameter mode (P-)	27	Axis number	<u>0</u> to 9	Invalid during RS-232C communication

The following settings are fixed; baud rate: 9600 bps, data length: 8 bits, stop bit: 1 bit, and parity: even.

Available Memory

The available memory setting range varies depending on the device. Be sure to set within the range available with the device to be used. Use [TYPE] when assigning the indirect memory for macro programs.

Memory	TYPE	Remarks
PRM (parameter) *1	00H	Double-word
TBL (point table) *2	01H	Double-word
OPE (basic operation)	02H	Double-word
MON (value monitor) *1	03H	Double-word, read only
IO (I/O monitor) *1	04H	Double-word, read only
ALM (alarm status) *1	05H	Double-word, read only
S (servo status)	06H	Double-word, read only
VV (internal monitor)	07H	Double-word, read only

*1 When using the parameter, value monitor, I/O monitor or alarm status memory, set the address with the number of digits shown below. For other types of memory, see "Memory Types" described later.

- Parameter, value monitor, I/O monitor: 8 digits
- Alarm status: 4 digits

*2 Address denotations

On the signal name reference list, every point number is designated as "00". To access any point number other than "00", manually input the desired number.

aabb

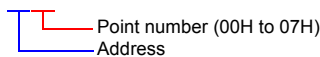

Memory Types

Device	Address	Name	Digits	Device	Address	Name	Digits
TBL (Point table)	0	Absolute/relative value	2	S (Servo status)	0	Servo status	8
	1	Distance of movement	8		1	Command point	2
	2	Speed	4		2	Motor type	2
	3	Acceleration/deceleration time constant	4		3	ROM version	4
	4	Wait time	4		4	System data 1	4
	5	Continuous motion	2		5	System data 2	4
	6	Branch target point number	2		6	System data 3	2
	7	Acceleration/deceleration ON/OFF at S	2	7	System data 4	2	
	8	Expansion (1)	2	Internal monitor (VV)	0	System data 1	2
9	Expansion (2)	4	1		System data 2	2	
OPE (Basic operation)	0	Write into EEPROM	1		2	System data 3	2
	1	Servo ON	1		3	System data 4	2
	2	Servo OFF	1		4	System data 5	2
	3	Emergency stop ON	1		5	System data 6	2
	4	Emergency stop OFF	1		6	System data 7	2
	5	Alarm reset	1		7	System data 8	2
	6	Start ON	1		8	Speed [rpm]	8
	7	Start OFF	1		9	Torque [%]	8
	8	Zero start ON	1		A	Torque (+-) peak [%]	8
	9	Zero start OFF	1		B	Current position [pulse]	8
	A	Zero deceleration ON	1		C	Position command [pulse]	8
	B	Zero deceleration OFF	1		D	Position deviation [pulse]	8
	C	Pause ON	1		E	Servo status	8
	D	Pause OFF	1		F	I/O status	8
	E	Single block ON	1		10	System data 9	4
	F	Single block OFF	1		11	System data 10	4
	10	Point No. designation	2		12	System data 11	4
	11	Log clear	1		13	Point being executed	2
	12	Torque peak reset	1				
	13	Machine zero point change	8				
	14	Reset	1				
15	Normal JOG	1					
16	Reverse JOG	1					
17	JOG stop	1					
18	General-purpose output setting	2					
19	General-purpose output	2					
1A	Smoothing setting	8					

PLC_CTL

Macro command "PLC_CTL F0 F1 F2"

Contents	F0	F1 (= \$u n)		F2
Data write of all axes (PRM, OPE)	1 - 8 (PLC1 - 8)	n	Command: 7FH *1	5
		n + 1	Device number 00H: Parameter (PRM) 02H: Basic operation (OPE)	
		n + 2	Address	
		n + 3	Data (lower)	
		n + 4	Data (higher)	
Data write of all axes *2 (TBL)	1 - 8 (PLC1 - 8)	n	Command: 7FH *1	23*3
		n + 1	Device number 01H: Point table (TBL)	
		n + 2	Point number: 0000H to 0007H	
		n + 3 to n + 4	Absolute/relative value: 0 to 1	
		n + 5 to n + 6	Distance of movement: -9999999 to 9999999	
		n + 7 to n + 8	Speed: 1 to 5000	
		n + 9 to n + 10	Acceleration/deceleration time constant: 1 to 9999	
		n + 11 to n + 12	Wait time: 0 to 9999	
		n + 13 to n + 14	Continuous motion: 0 to 1	
		n + 15 to n + 16	Branch target point number: 0 to 107	
		n + 17 to n + 18	S-shaped motion ON/OFF: 0 to 1	
		n + 19 to n + 20	Expansion 1 *3	
		n + 21 to n + 22	Expansion 2 *3	
Data write of each axis (PRM, OPE)	1 - 8 (PLC1 - 8)	n	Station number: 0100H to 0109H	5
		n + 1	Device number 00H: Parameter (PRM) 02H: Basic operation (OPE)	
		n + 2	Address	
		n + 3	Data (lower)	
		n + 4	Data (higher)	
Data write of each axis (TBL)	1 - 8 (PLC1 - 8)	n	Station number: 0100H to 0109H	23*3
		n + 1	Device number 01H: Point table (TBL)	
		n + 2	Point number: 0000H to 0007H	
		n + 3 to n + 4	Absolute/relative value: 0 to 1	
		n + 5 to n + 6	Distance of movement: -9999999 to 9999999	
		n + 7 to n + 8	Speed: 1 to 5000	
		n + 9 to n + 10	Acceleration/deceleration time constant: 1 to 9999	
		n + 11 to n + 12	Wait time: 0 to 9999	
		n + 13 to n + 14	Continuous motion: 0 to 1	
		n + 15 to n + 16	Branch target point number: 0 to 107	
		n + 17 to n + 18	S-shaped motion ON/OFF: 0 to 1	
		n + 19 to n + 20	Expansion 1 *3	
		n + 21 to n + 22	Expansion 2 *3	
Teaching	1 - 8 (PLC1 - 8)	n	Station number: 00H to 09H	2
		n + 1	Command: 0000H	
		n + 2	Data (lower)	
		n + 3	Data (higher)	

Contents	F0	F1 (= \$u n)	F2										
T waveform monitor sampling	1 - 8 (PLC1 - 8)	n	Station number: 00H to 09H	5									
		n + 1	Command: 0001H										
		n + 2	Control code Bit <table border="1" style="display: inline-table; vertical-align: middle;"> <tr><td>-</td><td>7</td><td>6</td><td>5</td><td>4</td><td>3</td><td>2</td><td>1</td><td>0</td></tr> </table> <ul style="list-style-type: none"> Trigger target <ul style="list-style-type: none"> 0: Speed 1: Torque 2: Servo status 3: Manual Trigger edge <ul style="list-style-type: none"> 0: Leading edge in normal turn 1: Trailing edge in normal turn 2: Leading edge in reverse turn 3: Trailing edge in reverse turn Sampling interval <ul style="list-style-type: none"> 0: 2 ms (50 ms/div) 1: 4 ms (100 ms/div) 2: 8 ms (200 ms/div) 3: 20 ms (500 ms/div) Operation command <ul style="list-style-type: none"> 0: Stop 1: Run 		-	7	6	5	4	3	2	1	0
		-	7		6	5	4	3	2	1	0		
		n + 3	Trigger position 00H to 1EH (0FH: Center)										
		n + 4	Servo status bit Bit <table border="1" style="display: inline-table; vertical-align: middle;"> <tr><td>-</td><td>7</td><td>6</td><td>5</td><td>4</td><td>3</td><td>2</td><td>1</td><td>0</td></tr> </table> <ul style="list-style-type: none"> Positioning 		-	7	6	5	4	3	2	1	0
		-	7		6	5	4	3	2	1	0		
		n + 5	Servo status										
		n + 6	Torque										
		n + 7	Speed										
		n + 8	Servo status										
		:	:										
		n + 51	Torque										
n + 52	Speed												
Servo status acquisition	1 - 8 (PLC1 - 8)	n	Station number: 00H to 09H	2									
		n + 1	Command: 0002H										
		n + 2 to n + 3	Servo status										
		n + 4 to n + 5	Command point										
		n + 6 to n + 7	Motor type										
		n + 8 to n + 9	ROM version										
		n + 10 to n + 11	System data										
		n + 12 to n + 13	System data										
		n + 14 to n + 15	System data										
		n + 16 to n + 17	System data										

Contents	F0	F1 (= \$u n)		F2
Internal monitor	1 - 8 (PLC1 - 8)	n	Station number: 00H to 09H	2
		n + 1	Command: 0003H	
		n + 2 to n + 3	System data	
		n + 4 to n + 5	System data	
		n + 6 to n + 7	System data	
		n + 8 to n + 9	System data	
		n + 10 to n + 11	System data	
		n + 12 to n + 13	System data	
		n + 14 to n + 15	System data	
		n + 16 to n + 17	System data	
		n + 18 to n + 19	Speed [rpm]	
		n + 20 to n + 21	Torque [%]	
		n + 22 to n + 23	Torque (+) peak [%]	
		n + 24 to n + 25	Current position [pulse]	
		n + 26 to n + 27	Position command [pulse]	
		n + 28 to n + 29	Position deviation [pulse]	
		n + 30 to n + 31	Servo status	
		n + 32 to n + 33	I/O status	
		n + 34 to n + 35	System data	
		n + 36 to n + 37	System data	
n + 38 to n + 39	System data			
n + 40 to n + 41	Point being executed			

 Return data: Data stored from AC servo to TS series

- *1 "FFH" can be set for the command (n) when Cuty Axis of version 2.50 and later is used.
- *2 When "01H: point table" is set for the device number (n + 1) of the "data write of all axes" command, the version of all connected Cuty Axis units must be unified into earlier than 2.50 or 2.50 and later.
- *3 "Expansion 1" and "expansion 2" settings are valid when Cuty Axis of version 2.50 and later is used.

Function	Expansion 1	Expansion 2
None	00	0000
Jump setting for input condition	01	Jump destination Point number: 0000 to 0007 Operation end: 0063
Loop setting	Number of loops: 02 to 64	Point number (single block function): 0064 to 0071
Torque setting	FF	Torque setting value [%]: 0001 to 0120
Loop counter clear	7F	Counter number to be cleared: 0000 to 0007

38.1.2 Wiring Diagrams

When Connected at COM1:

RS-422

Wiring diagram 1 - COM1

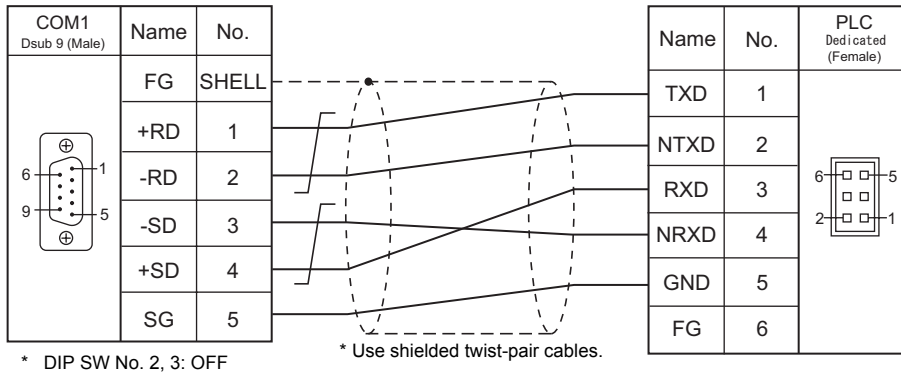

When Connected at COM2:

RS-232C

Wiring diagram 1 - COM2

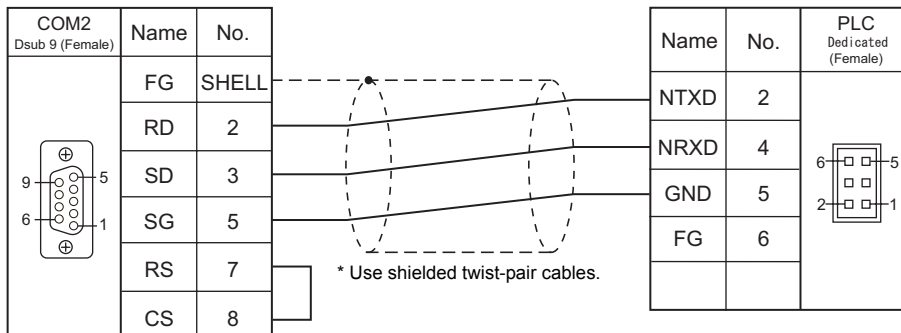

MEMO

Please use this page freely.

39. SHARP

39.1 PLC Connection

39.2 Temperature Controller/Servo/Inverter Connection

39.1 PLC Connection

Serial Connection

PLC Selection on the Editor	CPU		Unit/Port	Signal Level	TS Port	Connection	Ladder Transfer *1
JW series	W70H, W100H JW50, JW70, JW100 JW50H, JW70H, JW100H JW-50CU		JW-10CM ZW-10CM	RS-422	COM1	Wiring diagram 1 - COM1	×
					COM3	Wiring diagram 1 - COM3	
	JW20, JW20H, JW30H		JW-21CM	RS-422	COM1	Wiring diagram 1 - COM1	
					COM3	Wiring diagram 1 - COM3	
	JW10	JW-1324K JW-1342K JW-1424K JW-1442K JW-1624K JW-1642K	MMI port Communication port	RS-422	COM1	Wiring diagram 2 - COM1	
					COM1	Wiring diagram 3 - COM1	
	JW30H	JW-32CUH JW-32CUH1 JW-32CUM1 JW-33CUH JW-33CUH1 JW-33CUH2 JW-33CUH3	PG/COMM1 port	RS-422	COM1	Wiring diagram 4 - COM1	
					RS-232C	COM2	
			PG/COMM2 port	RS-422	COM1	Wiring diagram 4 - COM1	
	J-board	Z-331J Z-332J		Host communication port T1	RS-422	COM1	
COM3			Wiring diagram 1 - COM3				
JW100/70H COM port	JW70	JW-70CU	Communication port	RS-232C	COM2	Wiring diagram 2 - COM2	
	JW100	JW-100CU		RS-422	COM1	Wiring diagram 5 - COM1	
	JW70H	JW-70CUH	Communication port	RS-232C	COM2	Wiring diagram 2 - COM2	
	JW100H	JW-100CUH		RS-422	COM1	Wiring diagram 6 - COM1	
JW20 COM port	JW20H	JW-22CU	Communication port	RS-232C	COM2	Wiring diagram 2 - COM2	
	J-board	Z-311J Z-312J		Host communication port CN3	RS-232C	COM2	Wiring diagram 3 - COM2
			Host communication port TC1	RS-422	COM1	Wiring diagram 7 - COM1	
		Z-511J	PG/COMM1 port PG/COMM2 port	RS-422	COM1	Wiring diagram 4 - COM1	
		Z-512J	PG/COMM1 port PG/COMM2 port				
JW300 series	JW300	JW-311CU JW-312CU	PG/COMM1 port	RS-232C	COM2	Wiring diagram 4 - COM2	
				RS-422	COM1	Wiring diagram 4 - COM1	
		JW-21CM *2	RS-422	COM1	Wiring diagram 1 - COM1		
			COM3	Wiring diagram 1 - COM3			
		JW-321CU JW-322CU JW-331CU JW-332CU JW-341CU JW-342CU JW-352CU JW-362CU	PG/COMM1 port	RS-232C	COM2	Wiring diagram 4 - COM2	
				RS-422	COM1	Wiring diagram 4 - COM1	
	PG/COMM2 port		RS-232C	COM2	Wiring diagram 1 - COM2		
			RS-422	COM1	Wiring diagram 4 - COM1		
	JW-21CM *2	RS-422	COM1	Wiring diagram 1 - COM1			
			COM3	Wiring diagram 1 - COM3			

*1 For the ladder transfer function, see "Appendix 5 Ladder Transfer Function".

*2 When using this unit with JW300, be sure to use one of the JW300-compatible type. The JW300-compatible unit has a 300 mark on its front.

Ethernet Connection

PLC Selection on the Editor	CPU		Unit	TCP/IP	UDP/IP	Port No.	Ladder Transfer ^{*1}
JW series (Ethernet)	JW20H JW30H		JW-255CM	×	○	1001 to 65534	×
			JW-25TCM				
	JW50H JW70H JW100H		JW-50CM JW-51CM				
	J-board		Z-339J				
JW311/312/321/322 series (Ethernet)	JW300	JW-311CU JW-312CU JW-321CU JW-322CU	JW-255CM ^{*2}	×	○	1001 to 65534	×
			JW-25TCM ^{*2}				
JW331/332/341/342/352/362 series (Ethernet)	JW300	JW-331CU JW-332CU JW-341CU JW-342CU JW-352CU JW-362CU	JW-255CM ^{*2}	×	○	1001 to 65534	×
			JW-25TCM ^{*2}				

*1 For the ladder transfer function, see "Appendix 5 Ladder Transfer Function".

*2 When using the JW-21CM unit with JW300, be sure to use the JW300-compatible one. The 300 mark is provided on the front of the JW300-compatible unit.

39.1.1 JW Series

Communication Setting

Editor

Communication setting

(Underlined setting: default)

Item	Setting	Remarks
Connection Mode	<u>1</u> : 1 / 1 : n / Multi-link / Multi-link2	
Signal Level	RS-232C / <u>RS-422/485</u>	
Baud Rate	4800 / 9600 / <u>19200</u> / 38400 / 57600 / 115K bps	
Data Length	<u>7</u> / 8 bits	
Stop Bit	<u>1</u> / 2 bits	
Parity	None / Odd / <u>Even</u>	
Target Port No.	0 to 31	

- * For JW10 series with MMI port or communication port, turn off the terminating resistances of the TS series.
The following switches must be turned off.
COM1: DIP switches 6 and 7
COM3: DIP switch 8

PLC

Be sure to match the settings to those made on the [Communication Setting] tab window of the editor.

JW-10CM, ZW-10CM, JW-21CM Unit

Switch setting

Switch	Contents	Setting
SW0	Computer link (command mode)	4
SW1	Station address	1
SW2	Set the number from 01 to 37 in octal notation. SW1 denotes the lower-order digit, and SW2 denotes the higher-order digit.	0
SW3	1 Not used	OFF
	2 Communication system (ON: 4-wire system, OFF: 2-wire system)	ON
	3 Not used	OFF
	4 Parity (ON: even, OFF: odd)	ON
SW4	Baud rate 0: 19200, 1: 9600, 2: 4800	0
SW7	Terminating resistance (ON: provided, OFF: not provided)	ON

- * The following settings are fixed; data length: 7 bits, and stop bit: 2 bits.

Z-331J, Z-332J

Switch	Contents	Setting
SW0	Command mode	4
SW1	Station address	1
SW2	Set the number from 01 to 37 in octal notation. SW1 denotes the lower-order digit, and SW2 denotes the higher-order digit.	0
SW3	1 Not used	OFF
	2 Communication system (ON: 4-wire system, OFF: 2-wire system)	OFF
	3 Not used	OFF
	4 Parity (ON: even, OFF: odd)	ON
SW4	Baud rate 0: 19200, 1: 9600, 2: 4800	0
SW7	Terminating resistance (ON: provided, OFF: not provided)	ON

- * The following settings are fixed; data length: 7 bits, and stop bit: 2 bits.

JW-10

The settings for communications with the TS series should be made at the system memory as shown below.

MMI port

System Memory	Contents	Setting Example																
#226	Transmission specification <table border="1" style="margin-left: 20px;"> <tr> <td>D7</td><td>D6</td><td>D5</td><td>D4</td><td>D3</td><td>D2</td><td>D1</td><td>D0</td> </tr> <tr> <td>0</td><td>0</td><td>1</td><td>1</td><td>0</td><td>0</td><td>0</td><td>0</td> </tr> </table> <div style="margin-left: 20px;"> <p>→ Data length 0: 7 bits 1: 8 bits</p> <p>→ Stop bit 0: 1 bit 1: 2 bits</p> <p>→ Parity 00: None 01: Odd 10: Even</p> <p>→ Baud rate 111: 38400 bps 000: 19200 bps 001: 9600 bps 010: 4800 bps</p> </div>	D7	D6	D5	D4	D3	D2	D1	D0	0	0	1	1	0	0	0	0	30H Data length: 7 bits Stop bit: 2 bits Parity: even Baud rate: 19200 bps
D7	D6	D5	D4	D3	D2	D1	D0											
0	0	1	1	0	0	0	0											
#227	Port number: 001 to 037 (OCT)	01H																

* With the MMI port, only 1 : 1 or multi-link2 communication is available.

Communication port

System Memory	Contents	Setting Example																
#234	Communication mode: computer link mode	00H																
#236	Transmission specification <table border="1" style="margin-left: 20px;"> <tr> <td>D7</td><td>D6</td><td>D5</td><td>D4</td><td>D3</td><td>D2</td><td>D1</td><td>D0</td> </tr> <tr> <td>0</td><td>0</td><td>1</td><td>1</td><td>0</td><td>0</td><td>0</td><td>0</td> </tr> </table> <div style="margin-left: 20px;"> <p>→ Data length 0: 7 bits 1: 8 bits</p> <p>→ Stop bit 0: 1 bit 1: 2 bits</p> <p>→ Parity 00: None 01: Odd 10: Even</p> <p>→ Baud rate 111: 38400 bps 000: 19200 bps 001: 9600 bps 010: 4800 bps</p> </div>	D7	D6	D5	D4	D3	D2	D1	D0	0	0	1	1	0	0	0	0	30H Data length: 7 bits Stop bit: 2 bits Parity: even Baud rate: 19200 bps
D7	D6	D5	D4	D3	D2	D1	D0											
0	0	1	1	0	0	0	0											
#237	Port number: 001 to 037 (OCT)	01H																

JW-30H

PG/COMM1 port

System Memory	Contents	Setting Example																
#234	Transmission specification <table border="1" style="margin-left: 20px;"> <tr> <td>D7</td><td>D6</td><td>D5</td><td>D4</td><td>D3</td><td>D2</td><td>D1</td><td>D0</td> </tr> <tr> <td>0</td><td>0</td><td>1</td><td>1</td><td>0</td><td>0</td><td>0</td><td>0</td> </tr> </table> <div style="margin-left: 20px;"> <p>→ Stop bit 0: 1 bit 1: 2 bits</p> <p>→ Parity 00: None 01: Odd 10: Even</p> <p>→ Baud rate 101: 115 kbps*1 110: 57600 bps*1 111: 38400 bps*1 000: 19200 bps 001: 9600 bps 010: 4800 bps</p> </div>	D7	D6	D5	D4	D3	D2	D1	D0	0	0	1	1	0	0	0	0	30H Data length: 7 bits (fixed) Stop bit: 2 bits Parity: even Baud rate: 19200 bps
D7	D6	D5	D4	D3	D2	D1	D0											
0	0	1	1	0	0	0	0											
#235	Port number: 001 to 037 (OCT)	01H																

*1 Not available for JW-32CUH and JW-33CUH

PG/COMM2 port

System Memory	Contents	Setting Example																
#236	Transmission specification <table border="1" style="margin-left: auto; margin-right: auto;"> <thead> <tr> <th>D7</th><th>D6</th><th>D5</th><th>D4</th><th>D3</th><th>D2</th><th>D1</th><th>D0</th></tr> </thead> <tbody> <tr> <td>0</td><td>0</td><td>1</td><td>1</td><td>0</td><td>0</td><td>0</td><td>0</td></tr> </tbody> </table> <div style="display: flex; justify-content: space-around;"> <div style="text-align: left;"> <p>Stop bit 0: 1 bit 1: 2 bits</p> </div> <div style="text-align: left;"> <p>Parity 00: None 01: Odd 10: Even</p> </div> <div style="text-align: left;"> <p>Baud rate 101: 115 kbps^{*1} 110: 57600 bps^{*1} 111: 38400 bps^{*1} 000: 19200 bps 001: 9600 bps 010: 4800 bps</p> </div> </div>	D7	D6	D5	D4	D3	D2	D1	D0	0	0	1	1	0	0	0	0	30H Data length: 7 bits (fixed) Stop bit: 2 bits Parity: even Baud rate: 19200 bps
D7	D6	D5	D4	D3	D2	D1	D0											
0	0	1	1	0	0	0	0											
#237	Port number: 001 to 037 (OCT)	01H																

*1 Not available for JW-32CUH and JW-33CUH

Available Memory

The available memory setting range varies depending on the PLC model. Be sure to set within the range available for the PLC. Use [TYPE] when assigning the indirect memory for macro programs.

Memory	TYPE	Remarks
R (register)	00H	*1, *2
Relay (relay)	01H	<input type="checkbox"/> for word device *1
E (self diagnosis)	02H	*1
b (timer, counter/current value)	03H	*1
Fn (file register)	07H	*1, *3

*1 The addresses are expressed in "bytes". For word designation, specify an even-numbered address.

*2 The assigned memory is indicated when editing the screen as shown on the right.

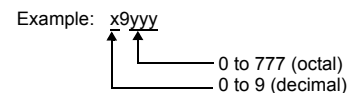

*3 The file number is required in addition to the memory type and address.

The assigned memory is indicated when editing the screen as shown on the right.

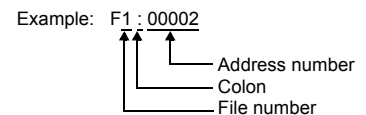

Indirect Memory Designation

- For R device "x9yyy":
Specify the value "x" (0 to 9: decimal) for higher bytes (bit 15 to 8).
Specify a value obtained by dividing "yyy" (000 to 777: octal) by 2 for lower bytes (bit 7 to 0).

Example: With indirect memory designation, "086D" (H) is assigned for "R89332".
 89 (ignoring the lower digit of "9") → 8 (DEC) → 08 (HEX)
 332 (OCT) → 218 (DEC) / 2 = 109 (DEC) → 6D (HEX)

- For Fn device:
Specify the file number in the expansion code.
- For any devices other than "R" or "Fn":
Example: With indirect memory designation, "01BF" (H) is assigned for " 1576".
 1576 (OCT) → 894 (DEC) / 2 = 447 (DEC) → 01BF (HEX)

39.1.2 JW100/70H COM Port

Communication Setting

Editor

Communication setting

Item	Setting	Remarks
Connection Mode	<u>1</u> : 1 / 1 : n / Multi-link / Multi-link2	
Signal Level	RS-232C / <u>RS-422/485</u>	
Baud Rate	4800 / 9600 / <u>19200</u> bps	
Data Length	7 bits	
Stop Bit	1 / <u>2</u> bits	
Parity	None / Odd / <u>Even</u>	
Target Port No.	0 to 31	

PLC

Be sure to match the settings to those made on the [Communication Setting] tab window of the editor.

JW-70CU/JW-100CU, JW-70CUH/JW-100CUH

The settings for communications with the TS series should be made at the system memory as shown below.

System Memory	Contents	Setting Example																
#236	Transmission specification <table border="1" style="margin-left: auto; margin-right: auto;"> <thead> <tr> <th>D7</th> <th>D6</th> <th>D5</th> <th>D4</th> <th>D3</th> <th>D2</th> <th>D1</th> <th>D0</th> </tr> </thead> <tbody> <tr> <td>0</td> <td>0</td> <td>1</td> <td>1</td> <td>0</td> <td>0</td> <td>0</td> <td>0</td> </tr> </tbody> </table> <p>Stop bit 0: 1 bit 1: 2 bits</p> <p>Parity 00: None 01: Odd 10: Even</p> <p>Baud rate 000: 19200 bps 001: 9600 bps 010: 4800 bps</p>	D7	D6	D5	D4	D3	D2	D1	D0	0	0	1	1	0	0	0	0	30H Data length: 7 bits (fixed) Stop bit: 2 bits Parity: even Baud rate: 19200 bps
D7	D6	D5	D4	D3	D2	D1	D0											
0	0	1	1	0	0	0	0											
#237	Port number: 001 to 037 (OCT)	01H																

Available Memory

The available memory setting range varies depending on the PLC model. Be sure to set within the range available for the PLC. Use [TYPE] when assigning the indirect memory for macro programs.

Memory	TYPE	Remarks
R (register)	00H	*1, *2
Relay (relay)	01H	□ for word device *1
E (self diagnosis)	02H	*1
b (timer, counter/current value)	03H	*1
Fn (file register)	07H	*1, *3

*1 The addresses are expressed in "bytes". For word designation, specify an even-numbered address.

*2 The assigned memory is indicated when editing the screen as shown on the right.

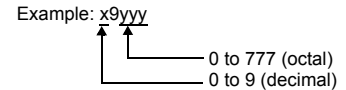

*3 The file number is required in addition to the memory type and address.

The assigned memory is indicated when editing the screen as shown on the right.

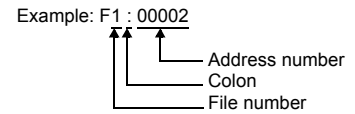

Indirect Memory Designation

- For R device "x9yyy":
Specify the value "x" (0 to 9: decimal) for higher bytes (bit 15 to 8).
Specify a value obtained by dividing "yyy" (000 to 777: octal) by 2 for lower bytes (bit 7 to 0).

Example: With indirect memory designation, "086D" is assigned for "R89332".
89 (ignoring the lower digit of "9") → 8 (DEC) → 08 (HEX)
332 (OCT) → 218 (DEC) / 2 = 109 (DEC) → 6D (HEX)

- For Fn device:
Specify the file number in the expansion code.
- For any devices other than "R" or "Fn":
Example: With indirect memory designation, "01BF" is assigned for "□ 1576".
1576 (OCT) → 894 (DEC) / 2 = 447 (DEC) → 01BF (HEX)

39.1.3 JW20 COM Port

Communication Setting

Editor

Communication setting

Item	Setting	Remarks
Connection Mode	<u>1</u> : 1 / 1 : n / Multi-link / Multi-link2	
Signal Level	RS-232C / <u>RS-422/485</u>	
Baud Rate	4800 / 9600 / <u>19200</u> bps	
Data Length	7 bits	
Stop Bit	1 / <u>2</u> bits	
Parity	None / Odd / <u>Even</u>	
Target Port No.	0 to 31	

PLC

Be sure to match the settings to those made on the [Communication Setting] tab window of the editor.

JW-22CU, Z-311J, Z-312J

The settings for communications with the TS series should be made at the system memory as shown below.

System Memory	Contents	Setting Example																
#236	Transmission specification <table border="1" style="margin-left: auto; margin-right: auto;"> <tr> <td>D7</td><td>D6</td><td>D5</td><td>D4</td><td>D3</td><td>D2</td><td>D1</td><td>D0</td> </tr> <tr> <td>0</td><td>0</td><td>1</td><td>1</td><td>0</td><td>0</td><td>0</td><td>0</td> </tr> </table> <div style="margin-left: 100px;"> <p>Stop bit 0: 1 bit 1: 2 bits</p> <p>Parity 00: None 01: Odd 10: Even</p> <p>Baud rate 000: 19200 bps 001: 9600 bps 010: 4800 bps</p> </div>	D7	D6	D5	D4	D3	D2	D1	D0	0	0	1	1	0	0	0	0	30H Data length: 7 bits (fixed) Stop bit: 2 bits Parity: even Baud rate: 19200 bps
D7	D6	D5	D4	D3	D2	D1	D0											
0	0	1	1	0	0	0	0											
#237	Port number: 001 to 037 (OCT)	01H																

* The terminating resistance switch (SW1) is provided at the back of the JW-22CU board. Turn this switch off for RS-232C connection.

Z-511J, Z-512J

PG/COMM1 port

System Memory	Contents	Setting Example																
#234	Transmission specification <table border="1" style="margin-left: auto; margin-right: auto;"> <tr> <td>D7</td><td>D6</td><td>D5</td><td>D4</td><td>D3</td><td>D2</td><td>D1</td><td>D0</td> </tr> <tr> <td>0</td><td>0</td><td>1</td><td>1</td><td>0</td><td>0</td><td>0</td><td>0</td> </tr> </table> <div style="margin-left: 100px;"> <p>Stop bit 0: 1 bit 1: 2 bits</p> <p>Parity 00: None 01: Odd 10: Even</p> <p>Baud rate 000: 19200 bps 001: 9600 bps 010: 4800 bps</p> </div>	D7	D6	D5	D4	D3	D2	D1	D0	0	0	1	1	0	0	0	0	30H Data length: 7 bits (fixed) Stop bit: 2 bits Parity: even Baud rate: 19200 bps
D7	D6	D5	D4	D3	D2	D1	D0											
0	0	1	1	0	0	0	0											
#235	Port number: 001 to 037 (OCT)	01H																

PG/COMM2 port

System Memory	Contents	Setting Example																
#236	Transmission specification <table border="1" style="margin-left: auto; margin-right: auto;"> <thead> <tr> <th>D7</th><th>D6</th><th>D5</th><th>D4</th><th>D3</th><th>D2</th><th>D1</th><th>D0</th></tr> </thead> <tbody> <tr> <td>0</td><td>0</td><td>1</td><td>1</td><td>0</td><td>0</td><td>0</td><td>0</td></tr> </tbody> </table> <div style="margin-left: 100px;"> <p>Stop bit 0: 1 bit 1: 2 bits</p> <p>Parity 00: None 01: Odd 10: Even</p> <p>Baud rate 000: 19200 bps 001: 9600 bps 010: 4800 bps</p> </div>	D7	D6	D5	D4	D3	D2	D1	D0	0	0	1	1	0	0	0	0	30H Data length: 7 bits (fixed) Stop bit: 2 bits Parity: even Baud rate: 19200 bps
D7	D6	D5	D4	D3	D2	D1	D0											
0	0	1	1	0	0	0	0											
#237	Port number: 001 to 037 (OCT)	01H																

Available Memory

The available memory setting range varies depending on the PLC model. Be sure to set within the range available for the PLC. Use [TYPE] when assigning the indirect memory for macro programs.

Memory	TYPE	Remarks
R (register)	00H	*1, *2
Relay (relay)	01H	<input type="checkbox"/> for word device *1
E (self diagnosis)	02H	*1
b (timer, counter/current value)	03H	*1
Fn (file register)	07H	*1, *3

*1 The addresses are expressed in "bytes". For word designation, specify an even-numbered address.

*2 The assigned memory is indicated when editing the screen as shown on the right.

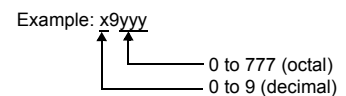

*3 The file number is required in addition to the memory type and address. The assigned memory is indicated when editing the screen as shown on the right.

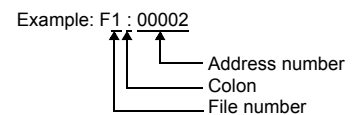

Indirect Memory Designation

- For R device "x9yyy":
Specify the value "x" (0 to 9: decimal) for higher bytes (bit 15 to 8).
Specify a value obtained by dividing "yyy" (000 to 777: octal) by 2 for lower bytes (bit 7 to 0).

Example: With indirect memory designation, "086D" is assigned for "R89332".
 89 (ignoring the lower digit of "9") → 8 (DEC) → 08 (HEX)
 332 (OCT) → 218 (DEC) / 2 = 109 (DEC) → 6D (HEX)

- For Fn device:
Specify the file number in the expansion code.
- For any devices other than "R" or "Fn":
Example: With indirect memory designation, "01BF" is assigned for " 1576".
 1576 (OCT) → 894 (DEC) / 2 = 447 (DEC) → 01BF (HEX)

39.1.4 JW300 Series

Communication Setting

Editor

Communication setting

(Underlined setting: default)

Item	Setting	Remarks
Connection Mode	<u>1</u> : 1 / 1 : n / Multi-link / Multi-link2 / Multi-link2 (Ethernet)	
Signal Level	RS-232C / <u>RS-422/485</u>	
Baud Rate	4800 / 9600 / 19200 / 38400 / <u>115K</u> bps	
Data Length	<u>7</u> / 8 bits	
Stop Bit	1 / <u>2</u> bits	
Parity	None / <u>Odd</u> / Even	
Target Port No.	0 to 31	
Transmission Mode	<u>2-wire</u> / 4-wire	Multi-link connection is not available in the 4-wire mode.

PLC

Be sure to match the settings to those made on the [Communication Setting] tab window of the editor.

PG/COMM 1 Port, PG/COMM 2 Port

Make PLC communication settings by using the application software "JW300SP" or writing the setting values directly into the system memory. For more information, refer to the PLC manual issued by the manufacturer.

JW300SP

	Item	Setting	Remarks
Port 1 Port 2	Baud Rate	115200 / 38400 / 19200 / 9600 / 4800	
	Parity	None / Odd / Even	
	Stop Bit	1 / 2	
	Station number	0 to 37 (OCT)	
	Data Length	7 bits / 8 bits	

System memory

PG/COMM 1 port

System Memory	Contents	Setting Example																
#234	Transmission specification <table border="1" style="margin-left: 20px;"> <tr> <td>D7</td><td>D6</td><td>D5</td><td>D4</td><td>D3</td><td>D2</td><td>D1</td><td>D0</td> </tr> <tr> <td>0</td><td>0</td><td>0</td><td>0</td><td>1</td><td>1</td><td>0</td><td>0</td> </tr> </table> 	D7	D6	D5	D4	D3	D2	D1	D0	0	0	0	0	1	1	0	0	0CH Data length: 7 bits Stop bit: 1 bit Parity: Odd Baud rate: 115 kbps
D7	D6	D5	D4	D3	D2	D1	D0											
0	0	0	0	1	1	0	0											
#235	Station number: 001 to 037 (OCT)	01H																

PG/COMM 2 port

System Memory	Contents	Setting Example																															
#236	Transmission specification <table border="1" style="margin-left: 20px;"> <tr> <th>D7</th><th>D6</th><th>D5</th><th>D4</th><th>D3</th><th>D2</th><th>D1</th><th>D0</th> </tr> <tr> <td>0</td><td>0</td><td>0</td><td>0</td><td>1</td><td>1</td><td>0</td><td>0</td> </tr> </table> <div style="margin-left: 20px;"> <table> <tr> <td>→ Data length</td> <td>0: 7 bits</td> <td>1: 8 bits</td> </tr> <tr> <td>→ Stop bit</td> <td>0: 1 bit</td> <td>1: 2 bits</td> </tr> <tr> <td>→ Parity</td> <td>00: None</td> <td>01: Odd</td> <td>10: Even</td> </tr> <tr> <td>→ Baud rate</td> <td>100: 115 kbps</td> <td>010: 38400 bps</td> <td>001: 19200 bps</td> <td>000: 9600 bps</td> </tr> </table> </div>	D7	D6	D5	D4	D3	D2	D1	D0	0	0	0	0	1	1	0	0	→ Data length	0: 7 bits	1: 8 bits	→ Stop bit	0: 1 bit	1: 2 bits	→ Parity	00: None	01: Odd	10: Even	→ Baud rate	100: 115 kbps	010: 38400 bps	001: 19200 bps	000: 9600 bps	0CH Data length: 7 bits Stop bit: 1 bit Parity: Odd Baud rate: 115 kbps
	D7	D6	D5	D4	D3	D2	D1	D0																									
0	0	0	0	1	1	0	0																										
→ Data length	0: 7 bits	1: 8 bits																															
→ Stop bit	0: 1 bit	1: 2 bits																															
→ Parity	00: None	01: Odd	10: Even																														
→ Baud rate	100: 115 kbps	010: 38400 bps	001: 19200 bps	000: 9600 bps																													
#237	Station number: 001 to 037 (OCT)	01H																															

JW-21CM Unit

Switch Setting

Switch	Contents	Setting	
SW0	Computer link (command mode)	4	
SW1	Station address	1	
SW2	Set the number from 01 to 37 in octal notation. SW1 denotes the lower-order digit, and SW2 denotes the higher-order digit. Do not set 00, 08, 09, 18, 19, 28, 29 and 40 or greater. When any of these number is set, an error occurs.	0	
SW3	1	Not used	OFF
	2	Communication system (ON: 4-wire / OFF: 2-wire)	ON
	3	Not used	OFF
	4	Parity (ON: Even / OFF: Odd)	ON
SW4	Baud rate 0: 19200, 1: 9600, 2: 4800	0	
SW7	Terminating resistance (ON: Provided / OFF: Not provided)	ON	

* The following settings are fixed; data length: 7 bits, and stop bit: 2 bits.

Available Memory

The available memory setting range varies depending on the PLC model. Be sure to set within the range available for the PLC. Use [TYPE] when assigning the indirect memory for macro programs.

Memory	TYPE	Remarks
R (register)	00H	*1, *2
Relay (relay)	01H	□ for word device *1
E (self diagnosis)	02H	*1
b (timer, counter/current value)	03H	*1
Fn (file register)	07H	*1, *3

*1 The addresses are expressed in "bytes". For word designation, specify an even-numbered address.

*2 The assigned memory is indicated when editing the screen as shown on the right.

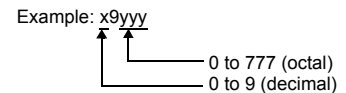

*3 The file number is required in addition to the memory type and address. The assigned memory is indicated when editing the screen as shown on the right.

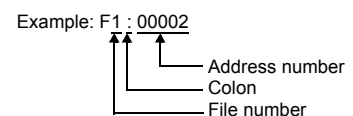

Indirect Memory Designation

- For R device "x9yyy":
Specify the value "x" (0 to 9: decimal) for higher bytes (bit 15 to 8).
Specify a value obtained by dividing "yyy" (000 to 777: octal) by 2 for lower bytes (bit 7 to 0).

Example: With indirect memory designation, "086D" is assigned for "R89332".
89 (ignoring the lower digit of "9") → 8 (DEC) → 08 (HEX)
332 (OCT) → 218 (DEC) / 2 = 109 (DEC) → 6D (HEX)

- For Fn device:
Specify the file number in the expansion code.
- For any devices other than "R" or "Fn":
Example: With indirect memory designation, "01BF" is assigned for "□ 1576".
1576 (OCT) → 894 (DEC) / 2 = 447 (DEC) → 01BF (HEX)

39.1.5 JW Series (Ethernet)

Communication Setting

Editor

Make the following settings on the editor. For more information, see Appendix 2 Ethernet.

- IP address for the TS unit
 - When specified on the screen data:
[System Setting] → [Ethernet Communication] → [Local Port IP Address]
 - When specified on the TS unit:
Main Menu screen → [Ethernet]
- Port number for the TS unit (for communication with PLC)
[System Setting] → [Device Connection Setting] → [Communication Setting]
- IP address and port number of the PLC
[System Setting] → [Device Connection Setting] → [PLC Table]

PLC

JW-255CM, JW-25TCM

Make PLC communication settings by using the application software or entering the setting values directly into the network parameter.

For more information, refer to the PLC manual issued by the manufacturer.

JW300SP (JW25TCM/255CM parameter settings)

	Item	Setting	Remarks
IP Address Setting	IP Address	Set the IP address of the PLC.	
	Subnet Mask	Set the subnet mask of the PLC.	
Connection Setting	Open Method	UDP	
	Local Port No.	Set the port number of the PLC.	

Network parameter

Parameter Address	Contents	Setting Example
0000 to 0003	IP address at local port (DEC)	IP address: 192.168.1.1 0000: 192 0001: 168 0002: 1 0003: 1
0004 to 0007	Subnet mask (DEC)	Subnet mask: 255.255.255.0 0004: 255 0005: 255 0006: 255 0007: 0
0100 to 0103	Connection 0 setting 0100: Open method 01: UDP 0101: Fixed to 0 0102: Local port number (lower byte (HEX)) 0103: Local port number (higher byte (HEX))	UDP connection, port number 3000 (= BB8H) 0100: 01H 0101: 00H 0102: B8H 0103: 0BH
0104 to 0107	Connection 1 setting (same as connection 0)	
0110 to 0113	Connection 2 setting (same as connection 0)	
0114 to 0117	Connection 3 setting (same as connection 0)	
0120 to 0123	Connection 4 setting (same as connection 0)	
0124 to 0127	Connection 5 setting (same as connection 0)	
0130 to 0133	Connection 6 setting (same as connection 0)	
0134 to 0137	Connection 7 setting (same as connection 0)	
3777 *	Communication start switch 00H: Communication stop 01H: Parameter check, BCC check, communication start 81H: Parameter check, BCC creation, writing into EEPROM, communication start (changed to 01H after the start of communication)	

* Communication must be stopped before entering values into the network parameter to make the communication setting. Specify 00H at parameter address 3777 at first, and set the IP address, etc. After settings are made, specify 81H at parameter address 3777. Then settings will be written into EEPROM and communication will start.

JW-50CM, JW-51CM

Make PLC communication settings by using the application software or entering the setting values directly into the network parameter.

For more information, refer to the PLC manual issued by the manufacturer.

JW300SP (Parameter settings)

Item	Setting	Remarks
IP Address Setting	IP Address	Set the IP address of the PLC.
	Subnet Mask	Set the subnet mask of the PLC.
Connection Setting	Open Method	UDP
	Local Port No.	Set the port number of the PLC.

Network parameter

Parameter Address	Contents	Setting Example
0000 to 0003	IP address at local port (DEC)	IP address: 192.168.1.1 0000: 192 0001: 168 0002: 1 0003: 1
0004 to 0007	Subnet mask (DEC)	Subnet mask: 255.255.255.0 0004: 255 0005: 255 0006: 255 0007: 0
0100 to 0103	Connection 0 setting 0100: Open method 01: UDP 0101: Fixed to 0 0102: Local port number (lower byte (HEX)) 0103: Local port number (higher byte (HEX))	UDP connection, port number 3000 (= BB8H) 0100: 01H 0101: 00H 0102: B8H 0103: 0BH
0104 to 0107	Connection 1 setting (same as connection 0)	
0110 to 0113	Connection 2 setting (same as connection 0)	
0114 to 0117	Connection 3 setting (same as connection 0)	
0120 to 0123	Connection 4 setting (same as connection 0)	
0124 to 0127	Connection 5 setting (same as connection 0)	
0130 to 0133	Connection 6 setting (same as connection 0)	
0134 to 0137	Connection 7 setting (same as connection 0)	
3777 *	Communication start switch 00H: Communication stop 01H: Parameter check, BCC check, communication start 81H: Parameter check, BCC creation, writing into EEPROM, communication start (changed to 01H after the start of communication)	

* Communication must be stopped before entering values into the network parameter to make the communication setting. Specify 00H at parameter address 3777 at first, and set the IP address, etc.

After settings are made, specify 81H at parameter address 3777. Then settings will be written into EEPROM and communication will start.

Z-339J

12-VDC Power Input

10BASE5 or 10BASE-T is selected according to the input status of the 12-VDC power supply.

12-VDC power input	Provided	10BASE5 communication
	Not provided	10BASE-T communication

Network parameter

Parameter Address	Contents	Setting Example
0000 to 0003	IP address at local port (DEC)	IP address: 192.168.1.1 0000: 192 0001: 168 0002: 1 0003: 1
0004 to 0007	Subnet mask (DEC)	Subnet mask: 255.255.255.0 0004: 255 0005: 255 0006: 255 0007: 0
0100 to 0103	Connection 0 setting 0100: Open method 01: UDP 0101: Fixed to 0 0102: Local port number (lower byte (HEX)) 0103: Local port number (higher byte (HEX))	UDP connection, port number 3000 (= BB8H) 0100: 01H 0101: 00H 0102: B8H 0103: 0BH
0104 to 0107	Connection 1 setting (same as connection 0)	
0110 to 0113	Connection 2 setting (same as connection 0)	
0114 to 0117	Connection 3 setting (same as connection 0)	
0120 to 0123	Connection 4 setting (same as connection 0)	
0124 to 0127	Connection 5 setting (same as connection 0)	
0130 to 0133	Connection 6 setting (same as connection 0)	
0134 to 0137	Connection 7 setting (same as connection 0)	
3777 *	Communication start switch 00H: Communication stop 01H: Parameter check, BCC check, communication start 81H: Parameter check, BCC creation, writing into EEPROM, communication start (changed to 01H after the start of communication)	

- * Communication must be stopped before entering values into the network parameter to make the communication setting. Specify 00H at parameter address 3777 at first, and set the IP address, etc. After settings are made, specify 81H at parameter address 3777. Then settings will be written into EEPROM and communication will start.

Available Memory

The available memory setting range varies depending on the PLC model. Be sure to set within the range available for the PLC. Use [TYPE] when assigning the indirect memory for macro programs.

Memory	TYPE	Remarks
R (register)	00H	*1, *2
Relay (relay)	01H	□ for word device *1
E (self diagnosis)	02H	*1
b (timer, counter/current value)	03H	*1
Fn (file register)	07H	*1, *3

*1 The addresses are expressed in "bytes". For word designation, specify an even-numbered address.

*2 The assigned memory is indicated when editing the screen as shown on the right.

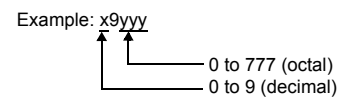

*3 The file number is required in addition to the memory type and address. The assigned memory is indicated when editing the screen as shown on the right.

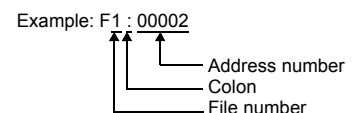

Indirect Memory Designation

- For R device "x9yyy":
Specify the value "x" (0 to 9: decimal) for higher bytes (bit 15 to 8).
Specify a value obtained by dividing "yyy" (000 to 777: octal) by 2 for lower bytes (bit 7 to 0).

Example: With indirect memory designation, "086D" is assigned for "R89332".
89 (ignoring the lower digit of "9") → 8 (DEC) → 08 (HEX)
332 (OCT) → 218 (DEC) / 2 = 109 (DEC) → 6D (HEX)

- For Fn device:
Specify the file number in the expansion code.
- For any devices other than "R" or "Fn":
Example: With indirect memory designation, "01BF" is assigned for "□ 1576".
1576 (OCT) → 894 (DEC) / 2 = 447 (DEC) → 01BF (HEX)

39.1.6 JW311/312/321/322 Series (Ethernet)

Communication Setting

Editor

Make the following settings on the editor. For more information, see Appendix 2 Ethernet.

- IP address for the TS unit
 - When specified on the screen data:
[System Setting] → [Ethernet Communication] → [Local Port IP Address]
 - When specified on the TS unit:
Main Menu screen → [Ethernet]
- Port number for the TS unit (for communication with PLC)
[System Setting] → [Device Connection Setting] → [Communication Setting]
- IP address and port number of the PLC
[System Setting] → [Device Connection Setting] → [PLC Table]

PLC

JW-255CM, JW-25TCM

Make PLC communication settings by using the application software or entering the setting values directly into the network parameter.

For more information, refer to the PLC manual issued by the manufacturer.

JW300SP (JW25TCM/255CM parameter settings)

Item	Setting	Remarks
IP Address Setting	IP Address	Set the IP address of the PLC.
	Subnet Mask	Set the subnet mask of the PLC.
Connection Setting	Open Method	UDP
	Local Port No.	Set the port number of the PLC.

Network parameter

Parameter Address	Contents	Setting Example
0000 to 0003	IP address at local port (DEC)	IP address: 192.168.1.1 0000: 192 0001: 168 0002: 1 0003: 1
0004 to 0007	Subnet mask (DEC)	Subnet mask: 255.255.255.0 0004: 255 0005: 255 0006: 255 0007: 0
0100 to 0103	Connection 0 setting 0100: Open method 01: UDP 0101: Fixed to 0 0102: Local port number (lower byte (HEX)) 0103: Local port number (higher byte (HEX))	UDP connection, port number 3000 (= BB8H) 0100: 01H 0101: 00H 0102: B8H 0103: 0BH
0104 to 0107	Connection 1 setting (same as connection 0)	
0110 to 0113	Connection 2 setting (same as connection 0)	
0114 to 0117	Connection 3 setting (same as connection 0)	
0120 to 0123	Connection 4 setting (same as connection 0)	
0124 to 0127	Connection 5 setting (same as connection 0)	
0130 to 0133	Connection 6 setting (same as connection 0)	
0134 to 0137	Connection 7 setting (same as connection 0)	
3777 *	Communication start switch 00H: Communication stop 01H: Parameter check, BCC check, communication start 81H: Parameter check, BCC creation, writing into EEPROM, communication start (changed to 01H after the start of communication)	

* Communication must be stopped before entering values into the network parameter to make the communication setting. Specify 00H at parameter address 3777 at first, and set the IP address, etc. After settings are made, specify 81H at parameter address 3777. Then settings will be written into EEPROM and communication will start.

Available Memory

The available memory setting range varies depending on the PLC model. Be sure to set within the range available for the PLC. Use [TYPE] when assigning the indirect memory for macro programs.

Memory	TYPE	Remarks
R (register)	00H	*1, *2
Relay (relay)	01H	□ for word device *1
E (self diagnosis)	02H	*1
b (timer, counter/current value)	03H	*1
Fn (file register)	07H	*1, *3

*1 The addresses are expressed in "bytes". For word designation, specify an even-numbered address.

*2 The assigned memory is indicated when editing the screen as shown on the right.

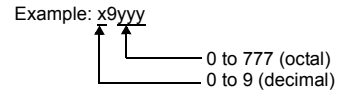

*3 The file number is required in addition to the memory type and address.

The assigned memory is indicated when editing the screen as shown on the right.

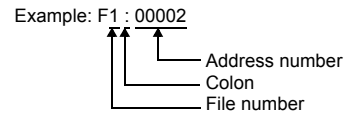

Indirect Memory Designation

- For R device "x9yyy":
Specify the value "x" (0 to 9: decimal) for higher bytes (bit 15 to 8).
Specify a value obtained by dividing "yyy" (000 to 777: octal) by 2 for lower bytes (bit 7 to 0).

Example: With indirect memory designation, "086D" is assigned for "R89332".
89 (ignoring the lower digit of "9") → 8 (DEC) → 08 (HEX)
332 (OCT) → 218 (DEC) / 2 = 109 (DEC) → 6D (HEX)

- For Fn device:
Specify the file number in the expansion code.
- For any devices other than "R" or "Fn":
Example: With indirect memory designation, "01BF" is assigned for "□ 1576".
1576 (OCT) → 894 (DEC) / 2 = 447 (DEC) → 01BF (HEX)

39.1.7 JW331/332/341/342/352/362 Series (Ethernet)

Settings are the same as those described in "39.1.6 JW311/312/321/322 Series (Ethernet)".

39.1.8 Wiring Diagrams

When Connected at COM1:

RS-422/RS-485

Wiring diagram 1 - COM1

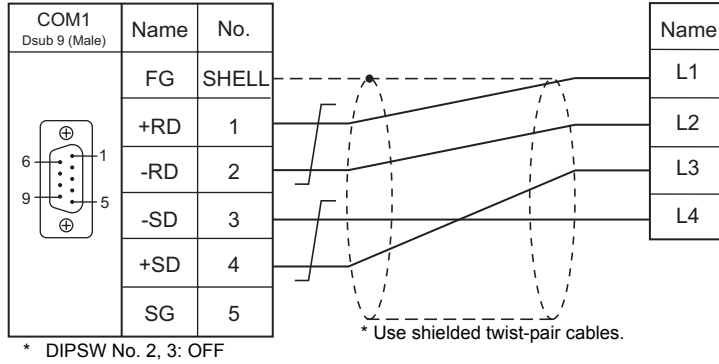

Wiring diagram 2 - COM1

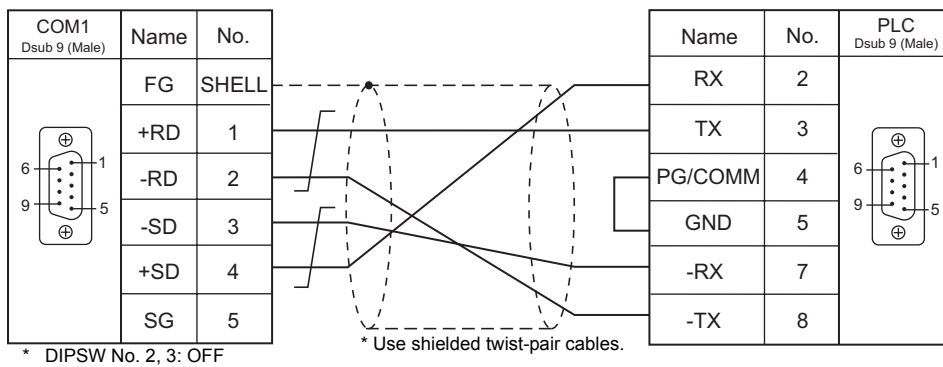

Wiring diagram 3 - COM1

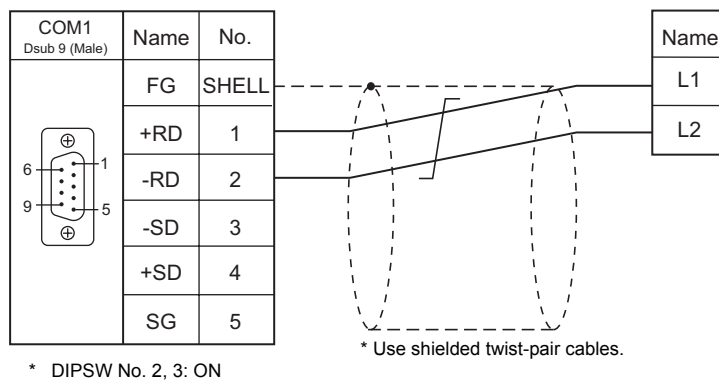

Wiring diagram 4 - COM1

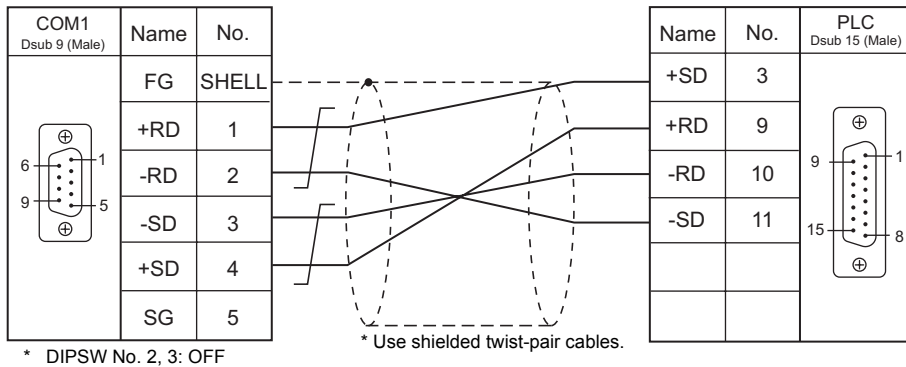

Wiring diagram 5 - COM1

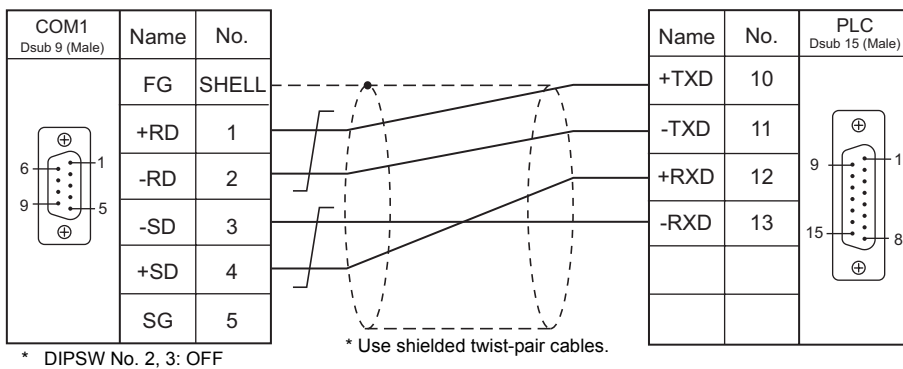

Wiring diagram 6 - COM1

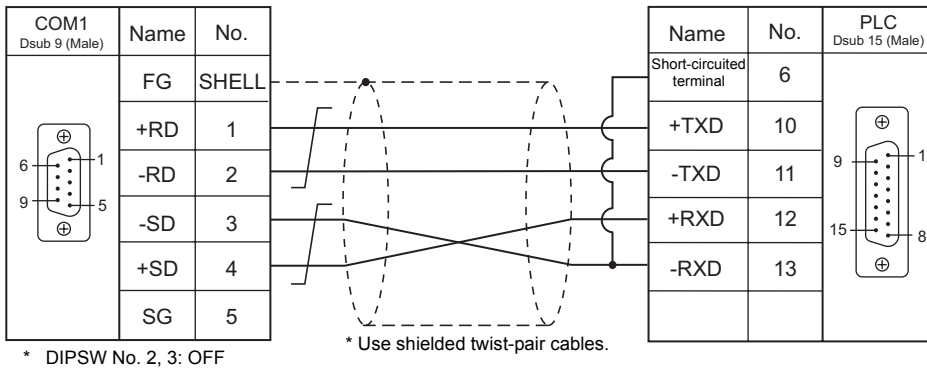

Wiring diagram 7 - COM1

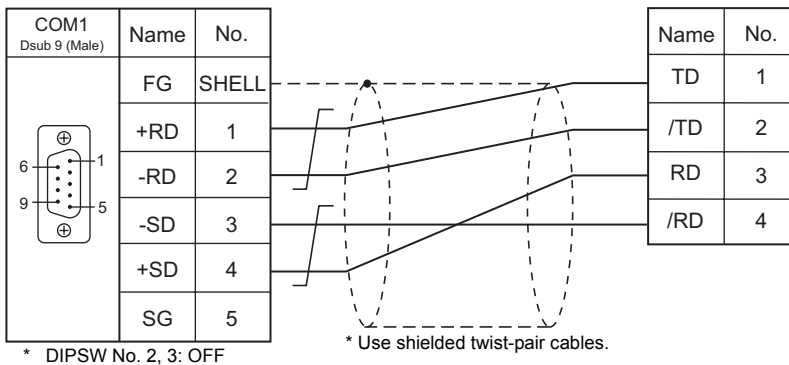

When Connected at COM2:

RS-232C

Wiring diagram 1 - COM2

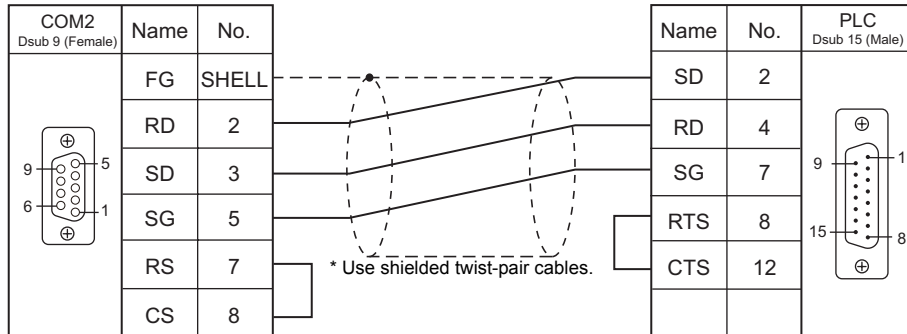

Wiring diagram 2 - COM2

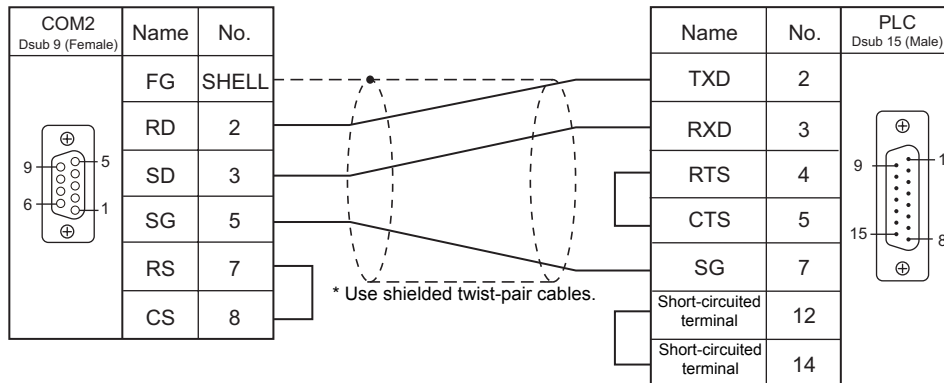

Wiring diagram 3 - COM2

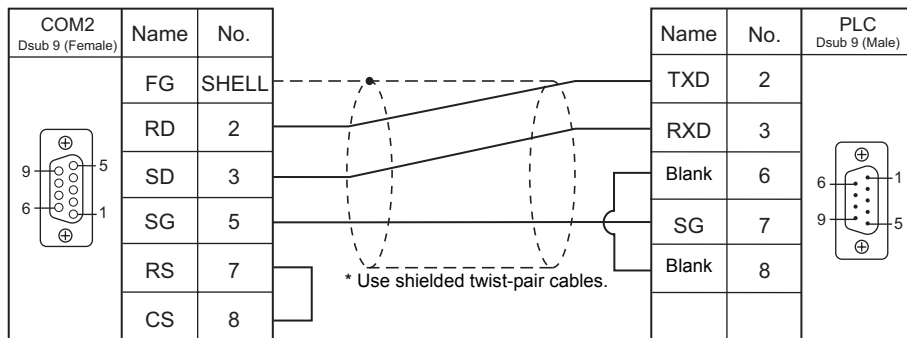

Wiring diagram 4 - COM2

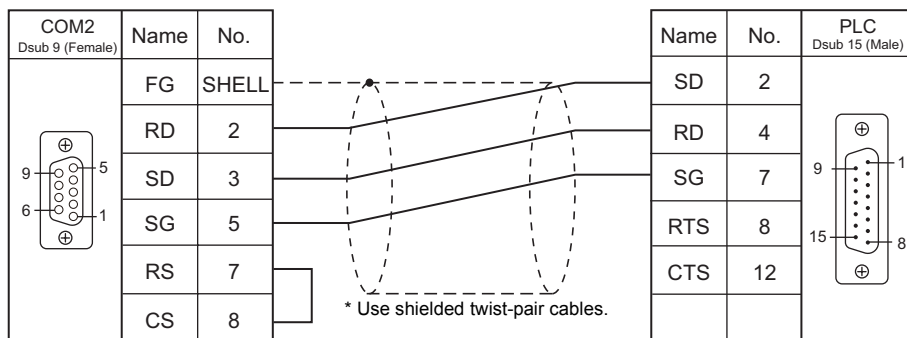

When Connected at COM3:

RS-485

Wiring diagram 1 - COM3

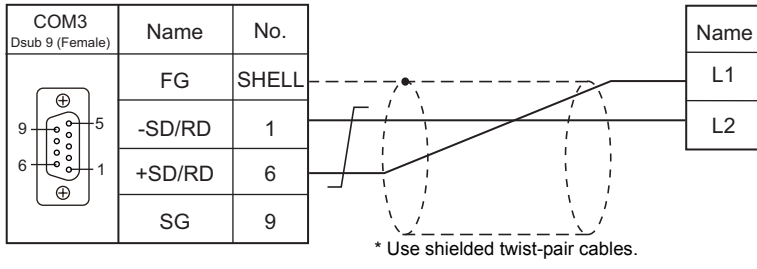

39.2 Temperature Controller/Servo/Inverter Connection

ID Controller

PLC Selection on the Editor	Model	Port	Signal Level	TS Port	Connection	Lst File
DS-30D	DS-30D	Terminal block	RS-232C	COM2	Wiring diagram 1 - COM2	SH-DS30D.Lst
			RS-422	COM1	Wiring diagram 1 - COM1	
		Connector for host/peripheral equipment	RS-232C	COM3	Wiring diagram 1 - COM3	
			RS-422	COM2	Wiring diagram 2 - COM2	
DS-32D	DS-32D	Host communication port 1	RS-232C	COM2	Wiring diagram 1 - COM2	SH-DS32D.Lst
		Host communication port 2	RS-422	COM1	Wiring diagram 1 - COM1	
			COM3	Wiring diagram 1 - COM3		
		MMI port	RS-232C	COM2	Wiring diagram 2 - COM2	

39.2.1 DS-30D

Communication Setting

Editor

Communication setting

(Underlined setting: default)

Item	Setting	Remarks
Connection Mode	1 : 1 / <u>1:n</u> / Multi-link2 / Multi-link2 (Ethernet) / 1 : n Multi-link2 (Ethernet)	
Signal Level	<u>RS-232C</u> / RS-422/485	
Baud Rate	4800 / <u>9600</u> / 19200 bps	
Data Length	<u>7</u> / 8 bits	
Stop Bit	<u>1</u> / 2 bits	
Parity	<u>None</u> / Odd / Even	
Target Port No.	<u>0</u> to 15	

RFID System

Switch Setting

Communication setting

(Underlined setting: default)

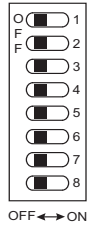
SW1	Function	OFF	ON	Setting Example									
1	Data length	<u>7</u>	8										
2	Parity	<u>None</u>	Provided										
3		<u>Even</u>	Odd										
4	Stop bit	<u>1</u>	2										
5	Connector type	<u>Using the host only</u>	Using the host and hand-held programmer (e.g. JW-12PG) at one time										
6	Communication system (wiring type)	<table border="1"> <thead> <tr> <th>RS-232C</th> <th>RS-422 (4-wire system)</th> <th>RS-485 (2-wire system)</th> </tr> </thead> <tbody> <tr> <td><u>OFF</u></td> <td>ON</td> <td>OFF</td> </tr> <tr> <td>OFF</td> <td>OFF</td> <td>ON</td> </tr> </tbody> </table>			RS-232C	RS-422 (4-wire system)	RS-485 (2-wire system)	<u>OFF</u>	ON	OFF	OFF	OFF	ON
RS-232C		RS-422 (4-wire system)	RS-485 (2-wire system)										
<u>OFF</u>	ON	OFF											
OFF	OFF	ON											
7													
8	Mode	<u>High speed</u>	Standard										

Station number setting

SW2	Contents	Setting Example
	<u>0</u> to F (H) (0 to 15)	0

Baud rate

SW3	Setting	Baud Rate	Setting Example
	4	4800 bps	5
	<u>5</u>	<u>9600 bps</u>	
	6	19200 bps	

Terminating resistance

SW4	Contents	Setting Example									
	<table border="1"> <thead> <tr> <th>RS-232C</th> <th>RS-422 (4-wire system)</th> <th>RS-485 (2-wire system)</th> </tr> </thead> <tbody> <tr> <td><u>OFF</u></td> <td>ON</td> <td>OFF</td> </tr> <tr> <td>OFF</td> <td>OFF</td> <td>ON</td> </tr> </tbody> </table>	RS-232C	RS-422 (4-wire system)	RS-485 (2-wire system)	<u>OFF</u>	ON	OFF	OFF	OFF	ON	1: OFF 2: OFF
RS-232C	RS-422 (4-wire system)	RS-485 (2-wire system)									
<u>OFF</u>	ON	OFF									
OFF	OFF	ON									

Communication Mode Setting

Set a communication mode at the system memory. The selected mode becomes effective when the power is turned off and on again.

Address	Contents	Setting
A008	Communication start method	0: At any time required
A00A	Response transmission method	0: Automatic

Available Memory

The available memory setting range varies depending on the device. Be sure to set within the range available with the device to be used. Use [TYPE] when assigning the indirect memory for macro programs.

Memory	TYPE	Remarks
CMUC (controller memory 1-byte data)	00H	
CMS (controller memory 2-byte data)	01H	
CMUT (controller memory 3-byte data)	02H	
CML (controller memory 4-byte data)	03H	
IMUC (ID memory 1-byte data)	04H	
IMS (ID memory 2-byte data)	05H	
IMUT (ID memory 3-byte data)	06H	
IML (ID memory 4-byte data)	07H	
ID (ID code)	08H	Double-word
TM (time)	09H	

*1 The CH number is required in addition to the memory type and address. The assigned memory is indicated when editing the screen as shown on the right.

Example: #0: CMUC9000

Address number
Memory type
CH number

Indirect Memory Designation

Specify the CH number in the expansion code.

PLC_CTL

Macro command "PLC_CTL F0 F1 F2"

Contents	F0	F1 (= \$u n)		F2	
Plate clear	1 - 8 (PLC1 - 8)	n	Station number		7/9
		n + 1	Command: 0		
		n + 2	CH No.		
		n + 3	Attribute (0, 3, A, D)	Attribute (1, 2, 4, 5, B, C, E, F)	
		n + 4	Address	Address	
		n + 5	Bytes	Bytes	
		n + 6	Clear data	Designated ID code	
		n + 7	-		
Plate initialize	1 - 8 (PLC1 - 8)	n	Station number		4/6
		n + 1	Command: 1		
		n + 2	CH No.		
		n + 3	Attribute (0, 3, A, D)	Attribute (1, 2, 4, 5, B, C, E, F)	
		n + 4	-	Designated ID code	
n + 5	-				
DS-30D clear	1 - 8 (PLC1 - 8)	n	Station number		6
		n + 1	Command: 2		
		n + 2	CH No.		
		n + 3	Address		
		n + 4	Bytes		
DS-30D initialize	1 - 8 (PLC1 - 8)	n	Station number		3
		n + 1	Command: 3		
		n + 2	CH No.		
		n + 3	Area 0: Communication time log 1: Retry count log 2: Error log		
		n + 4	-		
Plate self diagnosis	1 - 8 (PLC1 - 8)	n	Station number		6/8
		n + 1	Command: 5		
		n + 2	CH No.		
		n + 3	Attribute (0, 3, A, D)	Attribute (1, 2, 4, 5, B, C, E, F)	
		n + 4	Address	Address	
		n + 5	Bytes	Bytes	
		n + 6	Battery use rate	Designated ID code	
		n + 7	-		
n + 8	-	Battery use rate			
ROM check	1 - 8 (PLC1 - 8)	n	Station number		4/6
		n + 1	Command: 6		
		n + 2	CH No.		
		n + 3	Attribute (0, 3, A, D)	Attribute (1, 2, 4, 5, B, C, E, F)	
		n + 4	-	ID code	
n + 5	-				
RAM check	1 - 8 (PLC1 - 8)	n	Station number		6/8
		n + 1	Command: 7		
		n + 2	CH No.		
		n + 3	Attribute (0, 3, A, D)	Attribute (1, 2, 4, 5, B, C, E, F)	
		n + 4	Address	Address	
		n + 5	Bytes	Bytes	
		n + 6	-	Designated ID code	
n + 7	-				

Contents	F0	F1 (= \$u n)		F2	
Plate battery service life check	1 - 8 (PLC1 - 8)	n	Station number	4/6	
		n + 1	Command: 8		
		n + 2	CH No.		
		n + 3	Attribute (0, 3, A, D)		Attribute (1, 2, 4, 5, B, C, E, F)
		n + 4	Battery use rate		Designated ID code
		n + 5	-		
		n + 6	-		Battery use rate
DS-30D self diagnosis	1 - 8 (PLC1 - 8)	n	Station number	2	
		n + 1	Command: 9		
Block check	1 - 8 (PLC1 - 8)	n	Station number	6/8	
		n + 1	Command: 10		
		n + 2	CH No.		
		n + 3	Attribute (0, 3, A, D)		Attribute (1, 2, 4, 5, B, C, E, F)
		n + 4	Address		Address
		n + 5	Bytes		Bytes
		n + 6	-		Designated ID code
n + 7	-				
Reset	1 - 8 (PLC1 - 8)	n	Station number	3	
		n + 1	Command: 11		
		n + 2	CH No. 0: CH No. 0 1: CH No. 1 2: Both		
Output command	1 - 8 (PLC1 - 8)	n	Station number	7	
		n + 1	Command: 12		
		n + 2	CH No.		
		n + 3	Output 0		
		n + 4	Output 1		
		n + 5	Output 2		
		n + 6	Output 3		
Status read out	1 - 8 (PLC1 - 8)	n	Station number	3	
		n + 1	Command: 13		
		n + 2	CH No.		
		n + 3	Status		
DS-30D read out	1 - 8 (PLC1 - 8)	n	Station number	6	
		n + 1	Command: 14		
		n + 2	CH No.		
		n + 3	Address		
		n + 4	Bytes		
		n + 5	Internal memory address *1		
DS-30D write	1 - 8 (PLC1 - 8)	n	Station number	6	
		n + 1	Command: 15		
		n + 2	CH No.		
		n + 3	Address		
		n + 4	Bytes		
		n + 5	Internal memory address *2		
ID memory read out	1 - 8 (PLC1 - 8)	n	Station number	7/9	
		n + 1	Command: 16		
		n + 2	CH No.		
		n + 3	Attribute (0, 3, A, D)		Attribute (1, 2, 4, 5, B, C, E, F)
		n + 4	Address		Address
		n + 5	Bytes		Bytes
		n + 6	Internal memory address *1		Designated ID code
		n + 7	-		
n + 8	-	Internal memory address *1			

Contents	F0	F1 (= \$u n)		F2	
ID memory write	1 - 8 (PLC1 - 8)	n	Station number		7/9
		n + 1	Command: 17		
		n + 2	CH No.		
		n + 3	Attribute (0, 3, A, D)	Attribute (1, 2, 4, 5, B, C, E, F)	
		n + 4	Address	Address	
		n + 5	Bytes	Bytes	
		n + 6	Internal memory address *2	Designated ID code	
		n + 7	-		
		n + 8	-	Internal memory address *2	
ID code read out	1 - 8 (PLC1 - 8)	n	Station number		4/6
		n + 1	Command: 18		
		n + 2	CH No.		
		n + 3	Attribute (0, 3, A, D)	Attribute (1, 2, 4, 5, B, C, E, F)	
		n + 4	ID code	Designated ID code	
		n + 5	-		
		n + 6	-	ID code	
		n + 7	-		
ID code write	1 - 8 (PLC1 - 8)	n	Station number		6/8
		n + 1	Command: 19		
		n + 2	CH No.		
		n + 3	Attribute (0, 3, A, D)	Attribute (1, 2, 4, 5, B, C, E, F)	
		n + 4	ID code	Designated ID code	
		n + 5			
		n + 6	-	ID code	
		n + 7	-		
Time read out	1 - 8 (PLC1 - 8)	n	Station number		3
		n + 1	Command: 20		
		n + 2	CH No.		
		n + 3	Year		
		n + 4	Month		
		n + 5	Day		
		n + 6	Hour		
		n + 7	Minute		
		n + 8	Second		
		n + 9	A day of the week		
Time correction	1 - 8 (PLC1 - 8)	n	Station number		10
		n + 1	Command: 21		
		n + 2	CH No.		
		n + 3	Year		
		n + 4	Month		
		n + 5	Day		
		n + 6	Hour		
		n + 7	Minute		
		n + 8	Second		
		n + 9	A day of the week		

 Return data: Data stored from servo to TS series

*1 Specify the top address of the internal memory (\$u) at which the read data is to be stored.

*2 Specify the top address of the internal memory (\$u) at which data to be written is stored.

39.2.2 DS-32D

Communication Setting

Editor

Communication setting

(Underlined setting: default)

Item	Setting	Remarks
Connection Mode	1 : 1 / <u>1 : n</u> / Multi-link2 / Multi-link2 (Ethernet) / 1 : n Multi-link2 (Ethernet)	
Signal Level	<u>RS-232C</u> / RS-422/485	
Baud Rate	4800 / 9600 / 19200 / 38400 / 57600 / 76800 / <u>115k</u> bps	
Data Length	7 / <u>8</u> bits	
Stop Bit	<u>1</u> / 2 bits	
Parity	None / Odd / <u>Even</u>	
Target Port No.	<u>0</u> to 15	

*1 When RS-422 connection is used via the MMI port, the following settings are fixed; baud rate: 115 kbps, data length: 8 bits, stop bit: 1 bit, and parity: even.

RFID System

Switch Setting

Station number setting

(Underlined setting: default)

SW1	Contents	Setting Example
	<u>0</u> to F (H) (0 to 15)	0

Baud rate

SW2	Setting	Baud Rate	Setting Example
	4	4800 bps	9
	5	9600 bps	
	6	19200 bps	
	7	38400 bps	
	8	57600 bps	
	<u>9</u>	<u>115 kbps</u>	

Terminating resistance

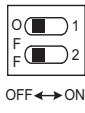
SW3	Contents			Setting Example
	RS-232C	RS-422 (4-wire system)	RS-485 (2-wire system)	1: OFF 2: OFF
	<u>OFF</u>	ON	OFF	
	<u>OFF</u>	ON	ON	

Communication setting

SW4	Function	OFF	ON	Setting Example	
1	Data length	7	8		
2	Parity	None	Provided		
3		Even	Odd		
4	Stop bit	1	2		
5	Fixed to OFF				
6	Communication system (wiring type)	RS-232C	RS-422 (4-wire system)		RS-485 (2-wire system)
7		OFF	ON		OFF
		OFF	OFF		ON
8	Fixed to OFF				
9	Fixed to OFF				

Communication Mode Setting

Set a communication mode at the system memory. The selected mode becomes effective when the power is turned off and on again.

Address	Contents	Setting
A008	Communication start method	0: At any time required
A00A	Response transmission method	0: Automatic
A00F	Trigger setting	0: Triggering invalid

Available Memory

The available memory setting range varies depending on the device. Be sure to set within the range available with the device to be used. Use [TYPE] when assigning the indirect memory for macro programs.

Memory	TYPE	Remarks
CMUC (controller memory 1-byte data)	00H	
CMS (controller memory 2-byte data)	01H	
CMUT (controller memory 3-byte data)	02H	
CML (controller memory 4-byte data)	03H	
IMUC (ID memory 1-byte data)	04H	
IMS (ID memory 2-byte data)	05H	
IMUT (ID memory 3-byte data)	06H	
IML (ID memory 4-byte data)	07H	
ID (ID code)	08H	Double-word
TM (time)	09H	
RWUC (reader/writer memory 1-byte data)	0AH	
RWS (reader/writer memory 2-byte data)	0BH	
RWUT (reader/writer memory 3-byte data)	0CH	
RWL (reader/writer memory 4-byte data)	0DH	

*1 The CH number is required in addition to the memory type and address. The assigned memory is indicated when editing the screen as shown on the right.

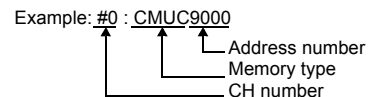

Indirect Memory Designation

Specify the CH number in the expansion code.

PLC_CTL

Macro command "PLC_CTL F0 F1 F2"

Contents	F0	F1 (= \$u n)		F2	
Tag memory clear	1 - 8 (PLC1 - 8)	n	Station number	7/11	
		n + 1	Command: 0		
		n + 2	CH No.		
		n + 3	Attribute (0, 8)		Attribute (1, 2, 9, A)
		n + 4	Address		Address
		n + 5	Bytes		Bytes
		n + 6	Clear data		UID (lower)
		n + 7	-		
		n + 8	-		UID (higher)
		n + 9	-		
n + 10	-	Clear data			
Controller clear	1 - 8 (PLC1 - 8)	n	Station number	6	
		n + 1	Command: 1		
		n + 2	CH No.		
		n + 3	Address		
		n + 4	Bytes		
		n + 5	Clear data		
Controller initialize	1 - 8 (PLC1 - 8)	n	Station number	3	
		n + 1	Command: 2		
		n + 2	CH No.		
Error log clear (communication time, number of retrials)	1 - 8 (PLC1 - 8)	n	Station number	4	
		n + 1	Command: 3		
		n + 2	CH No.		
		n + 3	Area 0: Communication time log 1: Retry count log		
Reader/writer memory clear	1 - 8 (PLC1 - 8)	n	Station number	7/9	
		n + 1	Command: 4		
		n + 2	CH No.		
		n + 3	Attribute (0, 8)		Attribute (1, 9)
		n + 4	Address		Address
		n + 5	Bytes		Bytes
		n + 6	Clear data		Identification sign
		n + 7	-		
n + 8	-	Clear data			
Controller self diagnosis	1 - 8 (PLC1 - 8)	n	Station number	3	
		n + 1	Command: 5		
		n + 2	CH No.		
Reader/writer self diagnosis	1 - 8 (PLC1 - 8)	n	Station number	4/6	
		n + 1	Command: 6		
		n + 2	CH No.		
		n + 3	Attribute (0, 8)		Attribute (1, 9)
		n + 4	-		Identification sign
		n + 5	-		
Error reset	1 - 8 (PLC1 - 8)	n	Station number	3	
		n + 1	Command: 7		
		n + 2	CH No. 0: CH No. 0 1: CH No. 1		

Contents	F0	F1 (= \$u n)		F2	
Output command	1 - 8 (PLC1 - 8)	n	Station number	5	
		n + 1	Command: 8		
		n + 2	CH No.		
		n + 3	OUT0 0: OFF 1: ON		
		n + 4	OUT1 0: OFF 1: ON		
Status read out	1 - 8 (PLC1 - 8)	n	Station number	3	
		n + 1	Command: 9		
		n + 2	CH No.		
		n + 3	Status		
Reader/writer reset	1 - 8 (PLC1 - 8)	n	Station number	4/6	
		n + 1	Command: 10		
		n + 2	CH No.		
		n + 3	Attribute (0, 8)		Attribute (1, 9)
		n + 4	-		Identification sign
		n + 5	-		
Reader/writer radio wave stop	1 - 8 (PLC1 - 8)	n	Station number	4	
		n + 1	Command: 11		
		n + 2	CH No.		
		n + 3	Command to reader/writer 0: Radio wave stop 1: Radio wave emit		
Input check	1 - 8 (PLC1 - 8)	n	Station number	3	
		n + 1	Command: 12		
		n + 2	CH No.		
		n + 3	IN0		
		n + 4	IN1		
Controller read out	1 - 8 (PLC1 - 8)	n	Station number	6	
		n + 1	Command: 13		
		n + 2	CH No.		
		n + 3	Address		
		n + 4	Bytes		
		n + 5	Internal memory address ^{*1}		
Controller write	1 - 8 (PLC1 - 8)	n	Station number	6	
		n + 1	Command: 14		
		n + 2	CH No.		
		n + 3	Address		
		n + 4	Bytes		
		n + 5	Internal memory address ^{*2}		
Tag read out	1 - 8 (PLC1 - 8)	n	Station number	7/11	
		n + 1	Command: 15		
		n + 2	CH No.		
		n + 3	Attribute (0, 3, 4, 8, B, C)		Attribute (1, 2, 5, 6, 9, A, D, E)
		n + 4	Address		Address
		n + 5	Bytes		Bytes
		n + 6	Internal memory address ^{*1}		UID (lower)
		n + 7	-		
		n + 8	-		UID (higher)
		n + 9	-		
		n + 10	-		Internal memory address ^{*1}

Contents	F0	F1 (= \$u n)		F2	
Tag write	1 - 8 (PLC1 - 8)	n	Station number		7/11
		n + 1	Command: 16		
		n + 2	CH No.		
		n + 3	Attribute (0, 3, 4, 8, B, C)	Attribute (1, 2, 5, 6, 9, A, D, E)	
		n + 4	Address	Address	
		n + 5	Bytes	Bytes	
		n + 6	Internal memory address *2	UID (lower)	
		n + 7	-		
		n + 8	-	UID (higher)	
		n + 9	-		
n + 10	-	Internal memory address *2			
Tag UID code read out	1 - 8 (PLC1 - 8)	n	Station number		5
		n + 1	Command: 17		
		n + 2	CH No.		
		n + 3	Attribute (0, 3, 4, 8, B, C)		
		n + 4	Internal memory address *1		
Time read out	1 - 8 (PLC1 - 8)	n	Station number		3
		n + 1	Command: 18		
		n + 2	CH No.		
		n + 3	Year		
		n + 4	Month		
		n + 5	Day		
		n + 6	Hour		
		n + 7	Minute		
		n + 8	Second		
n + 9	A day of the week				
Time setting	1 - 8 (PLC1 - 8)	n	Station number		10
		n + 1	Command: 19		
		n + 2	CH No.		
		n + 3	Year		
		n + 4	Month		
		n + 5	Day		
		n + 6	Hour		
		n + 7	Minute		
		n + 8	Second		
n + 9	A day of the week				
Reader/writer read out	1 - 8 (PLC1 - 8)	n	Station number		7/9
		n + 1	Command: 20		
		n + 2	CH No.		
		n + 3	Attribute (0, 8)	Attribute (1, 9)	
		n + 4	Address	Address	
		n + 5	Bytes	Bytes	
		n + 6	Internal memory address *1	Identification sign	
		n + 7	-		
n + 8	-	Internal memory address *1			
Reader/writer write	1 - 8 (PLC1 - 8)	n	Station number		7/9
		n + 1	Command: 21		
		n + 2	CH No.		
		n + 3	Attribute (0, 8)	Attribute (1, 9)	
		n + 4	Address	Address	
		n + 5	Bytes	Bytes	
		n + 6	Internal memory address *2	Identification sign	
		n + 7	-		
n + 8	-	Internal memory address *2			

Return data: Data stored from servo to TS series

- *1 Specify the top address of the internal memory (\$u) at which the read data is to be stored.
 *2 Specify the top address of the internal memory (\$u) at which data to be written is stored.

39.2.3 Wiring Diagrams

When Connected at COM1:

RS-422

Wiring diagram 1 - COM1

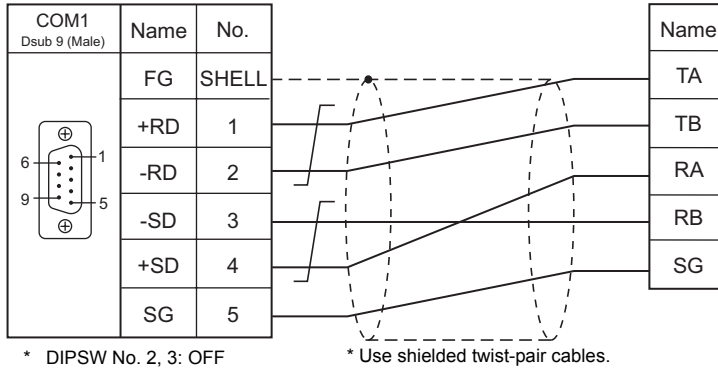

Wiring diagram 2 - COM1

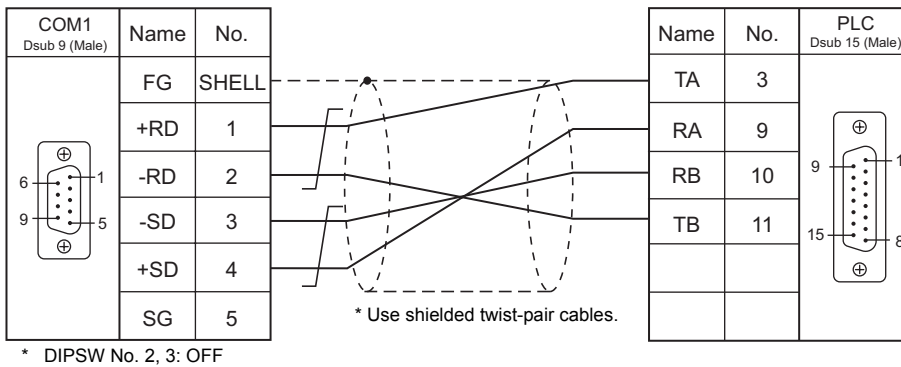

When Connected at COM2:

RS-232C

Wiring diagram 1 - COM2

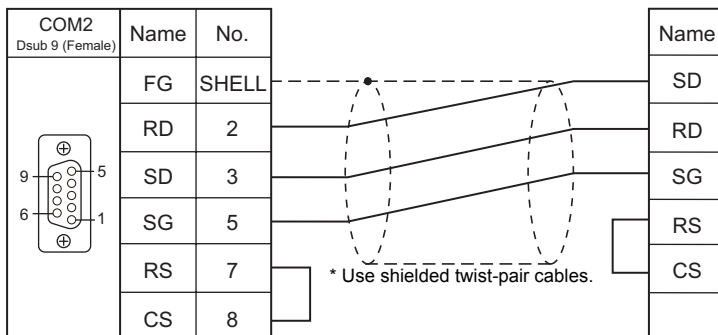

Wiring diagram 2 - COM2

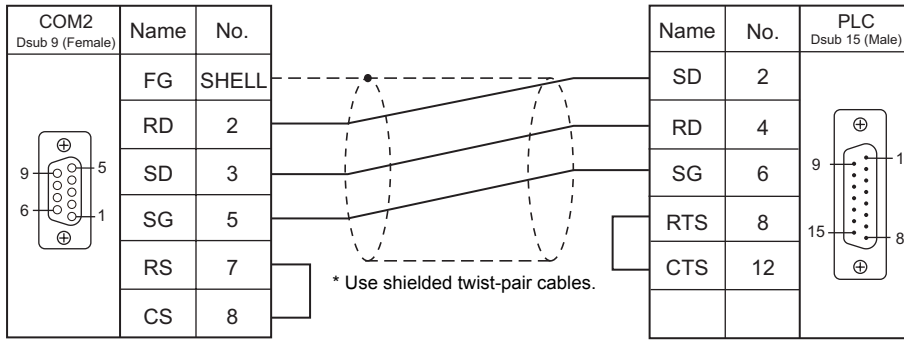

When Connected at COM3:

RS-485

Wiring diagram 1 - COM3

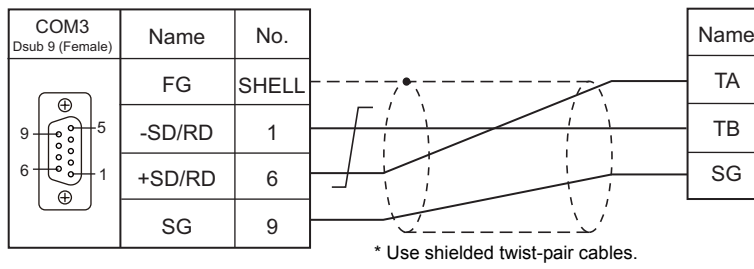

MEMO

Please use this page freely.

40. SHIMADEN

40.1 Temperature Controller / Servo / Inverter Connection

40.1 Temperature Controller / Servo / Inverter Connection

Controller / Indicator / Servo Controller

PLC Selection on the Editor	Model	Port	Signal Level	TS Port	Connection	Lst File	
SHIMADEN standard protocol	SR82-xx-N-xx-xxxx5xx SR83-xx-x-xx-xxxx5xx SR84-xx-x-xx-xxxx5xx SR91-xx-xx-x5x SR92-xx-x-xx-xx5x SR93-xx-x-xx-x05x SR94-xx-x-xx-x05x SR23-xxxx-xxxx5x FP93-xx-xx-xx5x MR13-xx1-xxxx15x SD16-xxx-xx5x EM70-xx-xxx5x	Terminal block	RS-485	COM1	Wiring diagram 1 - COM1	Shimaden. List	
	COM3			Wiring diagram 1 - COM3			
	SR82-xx-N-xx-xxxx7xx SR83-xx-x-xx-xxxx7xx SR84-xx-x-xx-xxxx7xx SR92-xx-x-xx-xx7x SR93-xx-x-xx-x07x SR94-xx-x-xx-x07x SR23-xxxx-xxxx7x FP93-xx-xx-xx7x MR13-xx1-xxxx17x SD16-xxx-xx7x EM70-xx-xxx7x	Terminal block	RS-232C	COM2	Wiring diagram 1 - COM2		
	SR253-xx-x-xxxxx5x			Communication port	RS-485		COM1 COM3
	SR253-xx-x-xxxxx6x	Communication port	RS-422	COM1	Wiring diagram 3 - COM1		
	SR253-xx-x-xxxxx7x	Communication port	RS-232C	COM2	Wiring diagram 2 - COM2		
	FP23-xxxx-xxxxx5x	Terminal block	RS-485	COM1	Wiring diagram 1 - COM1		ShimadenF P23.List
	FP23-xxxx-xxxxx7x			Terminal block	RS-232C		

40.1.1 SHIMADEN Standard Protocol

Communication Setting

Editor

Communication setting

(Underlined setting: default)

Item	Setting	Remarks
Connection Mode	1: 1 / <u>1:n</u> / Multi-link2 / Multi-link2 (Ethernet)	
Signal Level	<u>RS-232C</u> / RS-422/485	
Baud Rate	4800 / 9600 / <u>19200</u> bps	
Data Length	<u>7</u> / 8 bits	
Stop Bit	<u>1</u> / 2 bits	
Parity	None / Odd / <u>Even</u>	
Target Port No.	<u>1</u> to 31	
Sum Check	<u>Add</u> / Complement for Adding 2 / Exclusive OR / None	
CR/LF	<u>CR</u> / CR/LF	Only CR supported by the SR90/FP93/SD16 series
Write Data Count Setting	<u>1</u> to 10	

Controller / Indicator / Servo Controller

Communication parameters can be set by operating the front-mounted keys of the controller. Be sure to match the settings to those made on the [Communication Setting] tab window of the editor.

SR80 Series / EM70 Series

(Underlined setting: default)

Parameter Display	Item	Setting	Example
Comm	Communication mode *1	<u>LOC</u> : Read only COM: Read/write	COM
AdrS	Communication address	<u>1</u> to 99	1
bPS	Baud rate	4800 / 9600 / 19200 bps	19200
dAtA	Communication data format	<u>7E1</u> : 7 bits / even parity / 1 bit 7E2: 7 bits / even parity / 2 bits 7N1: 7 bits / none / 1 bit 7N2: 7 bits / none / 2 bits 8E1: 8 bits / even parity / 1 bit 8E2: 8 bits / even parity / 2 bits 8N1: 8 bits / none / 1 bit <u>8N2</u> : 8 bits / none / 2 bits	7E1
Ctrl	Communication control code	1: STX_ETX_CR 2: STX_ETX_CRLF	1
bcc	Communication BCC check	1: <u>ADD (addition)</u> 2: ADD_two's cmp (addition + 2's complement number) 3: XOR (exclusive OR) 4: None	1

*1 The front-mounted key works for switching COM → LOC only.
When writing from the TS, place "1" (= communication mode: COM) at address "018Cxx (H)". (xx: Subaddress)

SR90 Series

(Underlined setting: default)

Parameter Display	Item	Setting	Example
Comm	Communication mode *1	<u>LOC</u> : Read only COM: Read/write	COM
Prot	Communication protocol	<u>Shim: SHIMADEN protocol</u>	Shim
bcc	BCC calculation	1: <u>ADD (addition)</u> 2: ADD_two's cmp (addition + 2's complement number) 3: XOR (exclusive OR) 4: None	1
bPS	Baud rate	4800 / 9600 / 19200 bps	19200
Addr	Communication address	<u>1</u> to 255	1
dAtA	Communication data format	<u>7E1: 7 bits / even parity / 1 bit</u> 7E2: 7 bits / even parity / 2 bits 7N1: 7 bits / none / 1 bit 7N2: 7 bits / none / 2 bits 8E1: 8 bits / even parity / 1 bit 8E2: 8 bits / even parity / 2 bits 8N1: 8 bits / none / 1 bit 8N2: 8 bits / none / 2 bits	7E1
SchA	Start character	<u>STX</u>	STX

*1 The front-mounted key works for switching COM → LOC only.
When writing from the TS, place "1" (= communication mode: COM) at address "018Cxx (H)". (xx: Subaddress)

SR253 Series

(Underlined setting: default)

Group	Display	Item	Setting	Example
Group 1-2	Operation	Communication mode *1	<u>LOCAL</u> : Read only COMM: Read/write	COMM
Group 5-5A	Add	Machine address	<u>01</u> to 99	01
	BPS	Baud rate	4800 / 9600 / 19200 bps	19200
	DATA	Communication data format	<u>7E1: 7 bits / even parity / 1 bit</u> 7E2: 7 bits / even parity / 2 bits 7N1: 7 bits / none / 1 bit 7N2: 7 bits / none / 2 bits 8E1: 8 bits / even parity / 1 bit 8E2: 8 bits / even parity / 2 bits 8N1: 8 bits / none / 1 bit 8N2: 8 bits / none / 2 bits	7E1
	Mode	Communication protocol mode	<u>Standard: Standard protocol</u>	Standard
Group 5-5B	MEM	Communication memory mode	<u>EEP: EEPROM</u> RAM: RAM	EEP
	CTRL	Control code	<u>STX_ETX_CR</u> <u>STX_ETX_CRLF</u>	STX_ETX_CR
	BCC	Checksum	<u>ADD (addition)</u> ADD_two's cmp (addition + 2's complement number) XOR (exclusive OR) None	ADD
	DELY	Delay time	0 to 99 ms	40

*1 The front-mounted key works for switching COMM → LOCAL only.
When writing from the TS, place "1" (= communication mode: COM) at address "018Cxx (H)". (xx: Subaddress)

SR23 Series / FP23 Series

(Underlined setting: default)

Parameter Display	Item	Setting	Example
COM	Communication mode *1	<u>LOCAL</u> : Read only COM: Read/write	COM
PORT	Communication protocol mode	<u>SHIMADEN: SHIMADEN protocol</u>	SHIMADEN
ADDR	Device address	<u>1</u> to 98	1
BPS	Baud rate	4800 / 9600 / 19200 bps	19200
MEM	Communication memory mode	<u>EEP: EEPROM</u> RAM: RAM R_E: RAM/EPPROM *2	EEP
DATA	Data length	<u>7</u> / 8	7
PARI	Parity	<u>EVEN</u> / ODD / NONE	EVEN
STOP	Stop bit	<u>1</u> / 2	1
DELY	Communication delay time	1 to 50 ms	10
CTRL	Communication control code	STX_ETX_CR STX_ETX_CRLF	STX_ETX_CR
BCC	Communication BCC data calculation	<u>ADD (addition)</u> ADD_two's cmp (addition + 2's complement number) XOR (exclusive OR) None	ADD

*1 The front-mounted key works for switching COM → LOC only.

When writing from the TS, place "1" (= communication mode: COM) at address "018Cxx (H)". (xx: Subaddress)

*2 Data in SV, OUT, and COM modes will be written to RAM. Other data will be written to EPPROM.

FP93 Series

(Underlined setting: default)

Parameter Display	Item	Setting	Example
Comm	Communication mode *1	<u>LOC</u> : Read only COM: Read/write	COM
Addr	Communication address	<u>1</u> to 255	1
bPS	Baud Rate	4800 / 9600 / 19200 bps	19200
dAtA	Communication data format	<u>7E1: 7 bits / even parity / 1 bit</u> 8N1: 8 bits / none / 1 bit	7E1
Stx	Start character	<u>STX</u>	STX
bCC	Communication calculation	<u>1: Addition</u> 2: Addition + 2's complement number 3: XOR 4: None	1

*1 The front-mounted key works for switching COM → LOC only.

When writing from the TS, place "1" (= communication mode: COM) at address "018Cxx (H)". (xx: Subaddress)

MR13 Series

(Underlined setting: default)

Parameter Display	Item	Setting	Example
Com	Communication mode *1	<u>LOC</u> : Read only COM: Read/write	COM
Addr	Communication address	<u>1</u> to 99	1
bPS	Baud rate	4800 / 9600 / 19200 bps	19200
dAtA	Communication data format	<u>7E1</u> : 7 bits / even parity / 1 bit 7E2: 7 bits / even parity / 2 bits 7N1: 7 bits / none / 1 bit 7N2: 7 bits / none / 2 bits 8E1: 8 bits / even parity / 1 bit 8E2: 8 bits / even parity / 2 bits 8N1: 8 bits / none / 1 bit 8N2: 8 bits / none / 2 bits	7E1
mEm	Communication memory mode	<u>EEP</u> : EEPROM RAM: RAM	EEP
Ctrl	Communication control code	<u>1</u> : STX_ETX_CR 2: STX_ETX_CRLF	1
bCC	Communication checksum	<u>1</u> : ADD (addition) 2: ADD_two's cmp (addition + 2's complement number) 3: XOR (exclusive OR) 4: None	1

*1 The front-mounted key works for switching COM → LOC only.
When writing from the TS, place "1" (= communication mode: COM) at address "018Cxx (H)". (xx: Subaddress)

SD16 Series

(Underlined setting: default)

Parameter Display	Item	Setting	Example
Comm	Communication mode *1	<u>LOC</u> : Read only COM: Read/write	COM
Prot	Communication protocol mode	<u>SHIM</u> : SHIMADEN standard protocol	SHIM
Addr	Communication address	<u>1</u> to 100	1
dAtA	Communication data format	<u>7E1</u> : 7 bits / even parity / 1 bit 7E2: 7 bits / even parity / 2 bits 7N1: 7 bits / none / 1 bit 7N2: 7 bits / none / 2 bits 8E1: 8 bits / even parity / 1 bit 8E2: 8 bits / even parity / 2 bits 8N1: 8 bits / none / 1 bit 8N2: 8 bits / none / 2 bits	7E1
SchA	Communication start character	<u>STX</u>	STX
bcc	BCC calculation	<u>1</u> : ADD (addition) 2: ADD_two's cmp (addition + 2's complement number) 3: XOR 4: None	1
bPS	Baud rate	4800 / <u>9600</u> / 19200 bps	19200

*1 The front-mounted key works for switching COM → LOC only.
When writing from the TS, place "1" (= communication mode: COM) at address "018Cxx (H)". (xx: Subaddress)

Available Memory

The available memory setting range varies depending on the device. Be sure to set within the range available with the device to be used. Use [TYPE] when assigning the indirect memory for macro programs.

Memory	TYPE	Remarks
--	00H	

Address denotations

The assigned memory is indicated when editing the screen as shown below.

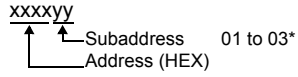

* Specify a channel as a subaddress.

SR23 series / FP23 series	: 01 to 02
MR13 series	: 01 to 03
Other models	: 01 (fixed)

Indirect Memory Designation

	15	8 7	0
n+0	Model	Memory type	
n+1	Address (lower)	Subaddress	
n+2	00	Address (higher)	
n+3	00	Bit designation	
n+4	00	Station number	

PLC_CTL

Macro command "PLC_CTL F0 F1 F2"

Contents	F0	F1 (= \$u n)	F2
Broadcast	1 to 8 (PLC1 to 8)	n	Station number: 0 (fixed)
		n+1	Address (lower) + subaddress
		n+2	Address (higher)
		n+3	Write data
			4

40.1.2 Wiring Diagrams

When Connected at COM1:

RS-422/RS-485

Wiring diagram 1 - COM1

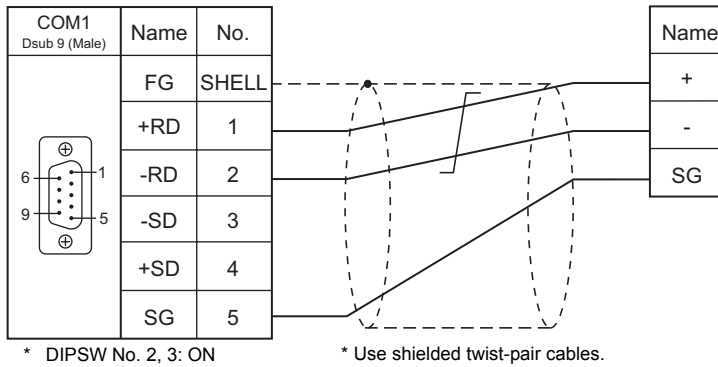

Wiring diagram 2 - COM1

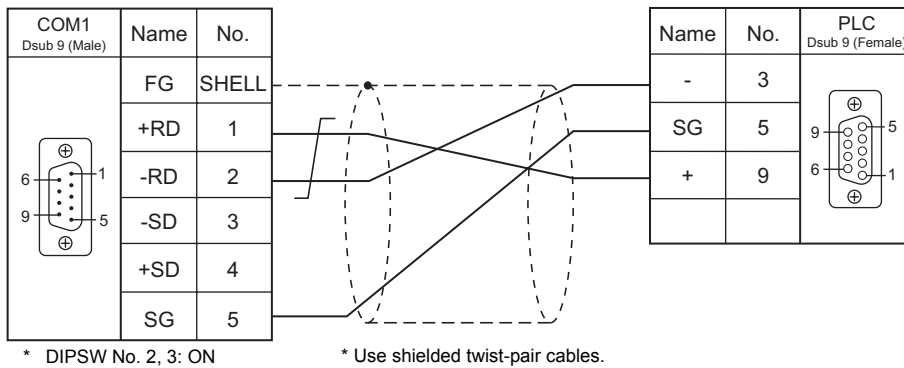

Wiring diagram 3 - COM1

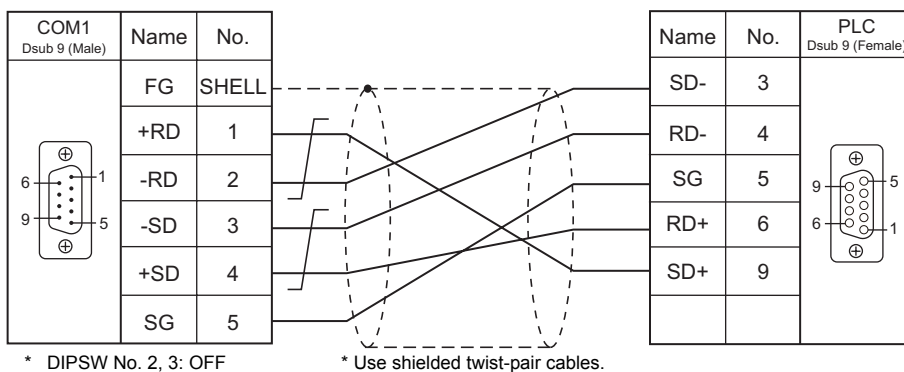

When Connected at COM2:

RS-232C

Wiring diagram 1 - COM2

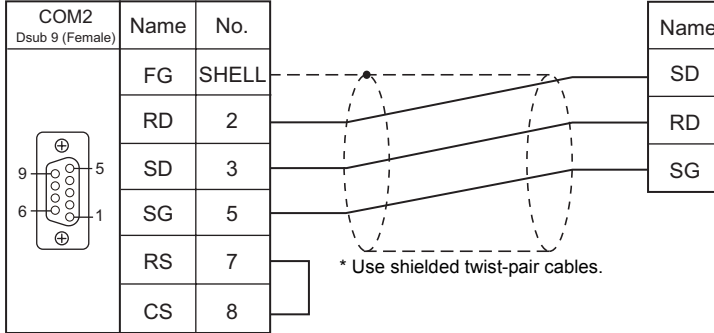

Wiring diagram 2 - COM2

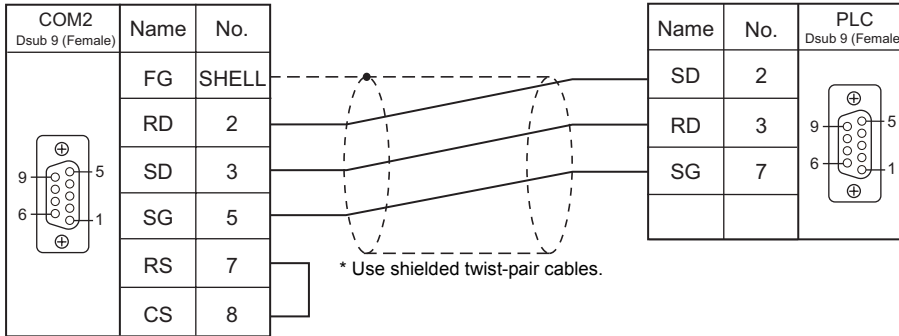

When Connected at COM3:

RS-485

Wiring diagram 1 - COM3

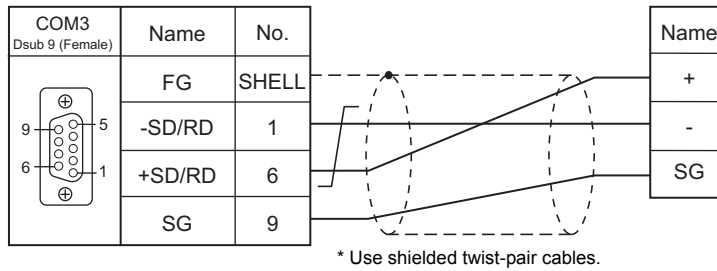

Wiring diagram 2 - COM3

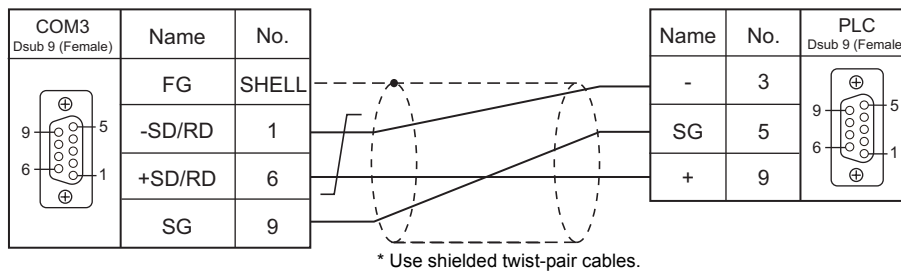

41. SHINKO TECHNOS

41.1 Temperature Controller/Servo/Inverter Connection

41.1 Temperature Controller/Servo/Inverter Connection

Serial Connection

Multi-point Temperature Control System

PLC Selection on the Editor	Model	Port	Signal Level	TS Port	Connection	Lst File
C Series	CPT-20A	Power source host link unit	RS-485	COM1	Wiring diagram 3 - COM1	S-C.Lst
				COM3	Wiring diagram 3 - COM3	

Digital Indicating Controller

PLC Selection on the Editor	Model	Port	Signal Level	TS Port	Connection	Lst File
FC Series	FCS-23A (C5, C) ^{*1}	Terminal block	RS-232C	COM2	Wiring diagram 1 - COM2	S-FC.Lst
	FCR-13A (C5, C) ^{*1} FCR-23A (C5, C) ^{*1} FCR-15A (C5, C) ^{*1}			RS-485	COM1	
	FCD-13A (C5, C) ^{*1} FCD-15A (C5, C) ^{*1}		COM3		Wiring diagram 1 - COM3	
GC Series	GCS-33x-x/x,C5	Terminal block	RS-485	COM1	Wiring diagram 1 - COM1	S-GC.Lst
				COM3	Wiring diagram 1 - COM3	
JCx-300 Series	JCS-33A-x/xx,C5 JCR-33A-x/xx,C5 JCD-33A-x/xx,C5	Terminal block	RS-485	COM1	Wiring diagram 1 - COM1	S-JC.Lst
				COM3	Wiring diagram 1 - COM3	
ACS-13A	ACS-13A-x/Mx,C5	Terminal block	RS-485	COM1	Wiring diagram 1 - COM1	S-ACS13A.Lst
				COM3	Wiring diagram 1 - COM3	
ACD/ACR Series	ACD-13A-x/Mx,(C5, C) ^{*1} ACR-13A-x/Mx,(C5, C) ^{*1} ACD-15A-R/Mx,(C5, C) ^{*1} ACR-15A-R/Mx,(C5, C) ^{*1}	Terminal block	RS-232C	COM2	Wiring diagram 1 - COM2	S-ACDR.Lst
			RS-485	COM1	Wiring diagram 1 - COM1	
				COM3	Wiring diagram 1 - COM3	
WCL-13A	WCL-13A-xx/xxx,C5	RS-485	RS-485	COM1	Wiring diagram 2 - COM1	S-WCL.Lst
				COM3	Wiring diagram 2 - COM3	

* Select a model with option C5 (serial communication RS-485) or C (serial communication RS-232C).

DIN-Rail-Mounted Indicating Controller

PLC Selection on the Editor	Model	Port	Signal Level	TS Port	Connection	Lst File
DCL-33A	DCL-33A-x/xx,C5	RS-485	RS-485	COM1	Wiring diagram 2 - COM1	S-DCL.Lst
				COM3	Wiring diagram 2 - COM3	

Program Controller

PLC Selection on the Editor	Model	Port	Signal Level	TS Port	Connection	Lst File
PCD-33A	PCD-33A-x/Mx,C5	Terminal block	RS-485	COM1	Wiring diagram 1 - COM1	S-PCD33A.Lst
				COM3	Wiring diagram 1 - COM3	
PC-900	PC-9x5-x/M,(C5, C) ^{*1}	Terminal block	RS-232C	COM2	Wiring diagram 1 - COM2	S-PC900.Lst
			RS-485	COM1	Wiring diagram 1 - COM1	
				COM3	Wiring diagram 1 - COM3	

*1 Select a model with option C5 (serial communication RS-485) or C (serial communication RS-232C).

41.1.1 C Series

Communication Setting

Editor

Communication setting

(Underlined setting: default)

Item	Setting	Remarks
Connection Mode	1 : 1 / <u>1:n</u> / Multi-link2 / Multi-link2 (Ethernet) / 1 : n Multi-link2 (Ethernet)	
Signal Level	RS-232C / <u>RS-422/485</u>	
Baud Rate	<u>9600</u> / 19200 bps	
Data Length	<u>7</u> / 8 bits	
Stop Bit	<u>1</u> / 2 bits	
Parity	None / Odd / <u>Even</u>	
Target Port No.	0 to 15	

C Series

Device number setting

STATION No.	Setting	Setting Example
	0 to F (H) (0 to 15)	0

Communication setting DIP switch

(Underlined setting: default)

Switch	Contents	OFF	ON	Setting Example															
1	Baud rate	<u>9600 bps</u>	19200 bps																
2	Terminating resistance	<u>Without terminating resistance</u>	With terminating resistance																
3	Communication format	<u>OFF</u> : Shinko standard protocol																	
4																			
5																			
6																			
7	Digital output setting	<table border="1"> <thead> <tr> <th>7</th> <th>8</th> <th>Contents</th> </tr> </thead> <tbody> <tr> <td><u>OFF</u></td> <td><u>OFF</u></td> <td>Turning ON/OFF by communication command *1</td> </tr> <tr> <td>ON</td> <td>OFF</td> <td>DO1: warning 1, DO2: warning 2, DO3: heater disconnection warning</td> </tr> <tr> <td>OFF</td> <td>ON</td> <td>DO1: warning 1, DO2: warning 2, DO3: abnormal loop warning</td> </tr> <tr> <td>ON</td> <td>ON</td> <td>DO1: warning 1, DO2: heater disconnection warning, DO3: abnormal loop warning</td> </tr> </tbody> </table>	7		8	Contents	<u>OFF</u>	<u>OFF</u>	Turning ON/OFF by communication command *1	ON	OFF	DO1: warning 1, DO2: warning 2, DO3: heater disconnection warning	OFF	ON	DO1: warning 1, DO2: warning 2, DO3: abnormal loop warning	ON	ON	DO1: warning 1, DO2: heater disconnection warning, DO3: abnormal loop warning	
7		8	Contents																
<u>OFF</u>		<u>OFF</u>	Turning ON/OFF by communication command *1																
ON		OFF	DO1: warning 1, DO2: warning 2, DO3: heater disconnection warning																
OFF	ON	DO1: warning 1, DO2: warning 2, DO3: abnormal loop warning																	
ON	ON	DO1: warning 1, DO2: heater disconnection warning, DO3: abnormal loop warning																	
8																			

*1 Works only when the data is sent to the address (digital output [0041xx]) on CPT-20A. For more information, refer to the instruction manual for the temperature controller issued by the manufacturer.

Available Memory

The available memory setting range varies depending on the controller model. Be sure to set within the range available for the controller. Use [TYPE] when assigning the indirect memory for macro programs.

Memory	TYPE	Remarks
---	00H	

Address denotations

- The assigned memory is indicated when editing the screen as shown below.

Example: XXXXY

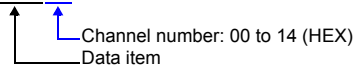

- On the signal name reference list, every channel number is designated as "00". To access any channel number other than "00", manually input the desired number.

41.1.2 FC Series

Communication Setting

Editor

Communication setting

(Underlined setting: default)

Item	Setting	Remarks
Connection Mode	1 : 1 / <u>1 : n</u> / Multi-link2 / Multi-link2 (Ethernet) / 1 : n Multi-link2 (Ethernet)	
Signal Level	RS-232C / <u>RS-422/485</u>	
Baud Rate	4800 / <u>9600</u> / 19200 bps	
Data Length	7 bits	
Stop Bit	1 bit	
Parity	Even	
Target Port No.	0 to 95	"95" is used for broadcasting.

FC Series

Auxiliary function setting mode 1

When the [MODE] key is held down for three seconds together with the [▼] key in the PV/SV display mode, the controller enters in "auxiliary function setting mode 1".

(Underlined setting: default)

Item	Setting	Remarks
Communication protocol selection	<u>Shinko standard</u>	Available only with FCS-23A, FCR-13A, FCR-23A and FCD-13A
Device number setting	<u>0</u> to 94	
Baud rate selection	4800 / <u>9600</u> / 19200 bps	

* The following settings are fixed; data length 7, stop bit 1 and even parity.

Available Memory

The available memory setting range varies depending on the controller model. Be sure to set within the range available for the controller. Use [TYPE] when assigning the indirect memory for macro programs.

Memory	TYPE	Remarks
---	00H	

Address denotations

- The assigned memory is indicated when editing the screen as shown below.

Example: XXXXYY

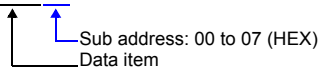

- On the signal name reference list, every sub address is designated as "00". To access any sub address other than "00", manually input the desired address.

41.1.3 GC Series

Communication Setting

Editor

Communication setting

(Underlined setting: default)

Item	Setting	Remarks
Connection Mode	1 : 1 / <u>1:n</u> / Multi-link2 / Multi-link2 (Ethernet) / 1 : n Multi-link2 (Ethernet)	
Signal Level	RS-232C / <u>RS-422/485</u>	
Baud Rate	4800 / <u>9600</u> / 19200 bps	
Data Length	7 bits	
Stop Bit	1 bit	
Parity	Even	
Target Port No.	0 to 95	"95" is used for broadcasting.

GC Series

Auxiliary function setting mode 1

When the [MODE] key is held down for three seconds together with the [▼] key in the PV/SV display mode, the controller enters in "auxiliary function setting mode 1".

(Underlined setting: default)

Item	Setting	Remarks
Device number setting	<u>0</u> to 94	
Baud rate selection	4800 / <u>9600</u> / 19200 bps	

* The following settings are fixed; data length 7, stop bit 1, even parity.

Available Memory

The available memory setting range varies depending on the controller model. Be sure to set within the range available for the controller. Use [TYPE] when assigning the indirect memory for macro programs.

Memory	TYPE	Remarks
---	00H	

Address denotations

- The assigned memory is indicated when editing the screen as shown below.

Example: XXXXYY

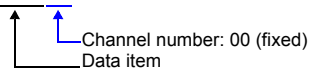

41.1.4 JCx-300 Series

Communication Setting

Editor

Communication setting

(Underlined setting: default)

Item	Setting	Remarks
Connection Mode	1 : 1 / <u>1:n</u> / Multi-link2 / Multi-link2 (Ethernet) / 1 : n Multi-link2 (Ethernet)	
Signal Level	RS-232C / <u>RS-422/485</u>	
Baud Rate	4800 / <u>9600</u> / 19200 bps	
Data Length	7 bits	
Stop Bit	1 bit	
Parity	Even	
Target Port No.	0 to 95	"95" is used for broadcasting.

JCx-300 Series

Auxiliary function setting mode 1

When the [MODE] key is held down for three seconds together with the [▼] key in the PV/SV display mode, the controller enters in "auxiliary function setting mode 1".

(Underlined setting: default)

Item	Setting	Remarks
Communication protocol selection	<u>Shinko standard</u>	
Communication device number setting	0 to 94	
Baud rate selection	4800 / <u>9600</u> / 19200 bps	
Parity selection	<u>Even</u>	Cannot be changed when the Shinko standard protocol is selected.
Stop bit selection	<u>1 bit</u>	

* The data length setting is fixed to "7".

Available Memory

The available memory setting range varies depending on the controller model. Be sure to set within the range available for the controller. Use [TYPE] when assigning the indirect memory for macro programs.

Memory	TYPE	Remarks
---	00H	

41.1.5 ACS-13A

Communication Setting

Editor

Communication setting

(Underlined setting: default)

Item	Setting	Remarks
Connection Mode	1 : 1 / <u>1 : n</u> / Multi-link2 / Multi-link2 (Ethernet) / 1 : n Multi-link2 (Ethernet)	
Signal Level	RS-232C / <u>RS-422/485</u>	
Baud Rate	4800 / <u>9600</u> / 19200 bps	
Data Length	7 bits	
Stop Bit	1 bit	
Parity	Even	
Target Port No.	0 to 95	"95" is used for broadcasting.

ACS-13A

Auxiliary function setting mode

When the [MODE] key is held down for three seconds together with the [▼] key in the PV/SV display mode, the controller enters in "auxiliary function setting mode".

(Underlined setting: default)

Item	Setting	Remarks
Communication protocol selection	<u>Shinko standard</u>	
Device number setting	<u>0</u> to 94	
Baud rate selection	4800 / <u>9600</u> / 19200 bps	
Data bit / parity selection	<u>7 bits / even</u>	
Stop bit selection	<u>1 bit</u>	

Available Memory

The available memory setting range varies depending on the controller model. Be sure to set within the range available for the controller. Use [TYPE] when assigning the indirect memory for macro programs.

Memory	TYPE	Remarks
---	00H	

41.1.6 ACD/ACR Series

Communication Setting

Editor

Communication setting

(Underlined setting: default)

Item	Setting	Remarks
Connection Mode	1 : 1 / <u>1:n</u> / Multi-link2 / Multi-link2 (Ethernet) / 1 : n Multi-link2 (Ethernet)	
Signal Level	RS-232C / <u>RS-422/485</u>	
Baud Rate	<u>9600</u> / 19200 / 38400 bps	
Data Length	<u>7</u> / 8 bits	
Stop Bit	<u>1</u> / 2 bits	
Parity	None / Odd / <u>Even</u>	
Target Port No.	0 to 95	"95" is used for broadcasting.

ACD/ACR Series

Communication parameter setting group

When the [SET] key is pressed four times and the [MODE] key is pressed in the PV/SV display mode, the controller enters in "input parameter group".

In this state, press the [SET] key several times again. The controller enters in "communication parameter setting group".

(Underlined setting: default)

Item	Setting	Remarks
Communication protocol selection	<u>Shinko standard</u>	
Device number setting	<u>0</u> to 94	
Baud rate selection	<u>9600</u> / 19200 / 38400 bps	
Data bit / parity selection	8 bits / no parity 7 bits / no parity 8 bits / even <u>7 bits / even</u> 8 bits / odd 7 bits / odd	
Stop bit selection	<u>1 bit</u> 2 bits	

Available Memory

The available memory setting range varies depending on the controller model. Be sure to set within the range available for the controller. Use [TYPE] when assigning the indirect memory for macro programs.

Memory	TYPE	Remarks
---	00H	

41.1.7 WCL-13A

Communication Setting

Editor

Communication setting

(Underlined setting: default)

Item	Setting	Remarks
Connection Mode	1 : 1 / <u>1:n</u> / Multi-link2 / Multi-link2 (Ethernet) / 1 : n Multi-link2 (Ethernet)	
Signal Level	RS-232C / <u>RS-422/485</u>	
Baud Rate	<u>9600</u> / 19200 / 38400 bps	
Data Length	7 bits	
Stop Bit	1 bit	
Parity	Even	
Target Port No.	0 to 95	"95" is used for broadcasting.

WCL-13A

Specific function setting group

When the [MODE] key is pressed several times in the PV/SV display mode, the controller enters in "specific function setting group".

(Underlined setting: default)

Item	Setting	Remarks
Communication protocol selection	<u>Shinko standard</u>	
Device number setting	<u>0</u> to 94	
Baud rate selection	<u>9600</u> / 19200 / 38400 bps	
Data bit / parity selection	<u>7 bits / even</u>	
Stop bit selection	<u>1 bit</u>	

Available Memory

The available memory setting range varies depending on the controller model. Be sure to set within the range available for the controller. Use [TYPE] when assigning the indirect memory for macro programs.

Memory	TYPE	Remarks
---	00H	

41.1.8 DCL-33A

Communication Setting

Editor

Communication setting

(Underlined setting: default)

Item	Setting	Remarks
Connection Mode	1 : 1 / <u>1:n</u> / Multi-link2	
Signal Level	<u>RS-422/485</u>	
Baud Rate	4800 / <u>9600</u> / 19200 bps	
Data Length	7 bits	
Stop Bit	1 bit	
Parity	Even	
Target Port No.	0 to 31	

DCL-33A

Auxiliary function setting mode 1

When the [MODE] key is held down for three seconds together with the [▼] key in the PV/SV display mode, the controller enters in the “auxiliary function setting” mode.

(Underlined setting: default)

Item	Setting	Remarks
Communication protocol selection	<u>Shinko standard</u>	
Communication device number setting	<u>0</u> to 31	
Baud rate selection	4800 / <u>9600</u> / 19200 bps	
Parity selection	Even	Cannot be changed when the Shinko standard protocol is selected.
Stop bit selection	1 bit	

* The data length setting is fixed to “7”.

Available Memory

The available memory setting range varies depending on the controller model. Be sure to set within the range available for the controller. Use [TYPE] when assigning the indirect memory for macro programs.

Memory	TYPE	Remarks
---	00H	

41.1.9 PCD-33A

Communication Setting

Editor

Communication setting

(Underlined setting: default)

Item	Setting	Remarks
Connection Mode	1 : 1 / <u>1 : n</u> / Multi-link2 / Multi-link2 (Ethernet) / 1 : n Multi-link2 (Ethernet)	
Signal Level	RS-232C / <u>RS-422/485</u>	
Baud Rate	4800 / <u>9600</u> / 19200 bps	
Data Length	7 bits	
Stop Bit	1 bit	
Parity	Even	
Target Port No.	0 to 95	"95" is used for broadcasting.

PCD-33A

Auxiliary function setting mode 1

When the [MODE] key is held down for three seconds together with the [▼] key in the PV/SV display mode, the controller enters in "auxiliary function setting mode 1".

(Underlined setting: default)

Item	Setting	Remarks
Communication protocol selection	<u>Shinko standard</u>	
Device number setting	<u>0</u> to 94	
Baud rate selection	<u>9600</u> / 19200 / 38400 bps	
Parity selection	<u>Even</u>	Cannot be changed when the Shinko standard protocol is selected.
Stop bit selection	<u>1 bit</u>	

* The data length setting is fixed to "7".

Available Memory

The available memory setting range varies depending on the controller model. Be sure to set within the range available for the controller. Use [TYPE] when assigning the indirect memory for macro programs.

Memory	TYPE	Remarks
---	00H	

41.1.10 PC-900

Communication Setting

Editor

Communication setting

(Underlined setting: default)

Item	Setting	Remarks
Connection Mode	1 : 1 / <u>1:n</u> / Multi-link2 / Multi-link2 (Ethernet) / 1 : n Multi-link2 (Ethernet)	
Signal Level	RS-232C / <u>RS-422/485</u>	
Baud Rate	4800 / <u>9600</u> / 19200 bps	
Data Length	7 bits	
Stop Bit	1 bit	
Parity	Even	
Target Port No.	0 to 95	"95" is used for broadcasting.

PC-900

Communication parameter

Press the [SET/RST] key in the standby mode or program control execution mode, press the [STOP/MODE] key four times, and then press the [HOLD/ENT] key to select "auxiliary function setting mode". In this state, press the [STOP/MODE] key five times and then press the [HOLD/ENT] key to select "communication parameter". For more information, refer to the instruction manual for the PC-900.

(Underlined setting: default)

Item	Setting	Remarks
Baud rate selection	4800 / <u>9600</u> / 19200 bps	
Device number setting	<u>0</u> to 94	
Communication mode selection	<u>Serial communication</u>	

* The following settings are fixed; data length 7, stop bit 1, even parity.

Available Memory

The available memory setting range varies depending on the controller model. Be sure to set within the range available for the controller. Use [TYPE] when assigning the indirect memory for macro programs.

Memory	TYPE	Remarks
---	00H	

41.1.11 Wiring Diagrams

When Connected at COM1:

RS-422/RS-485

Wiring diagram 1 - COM1

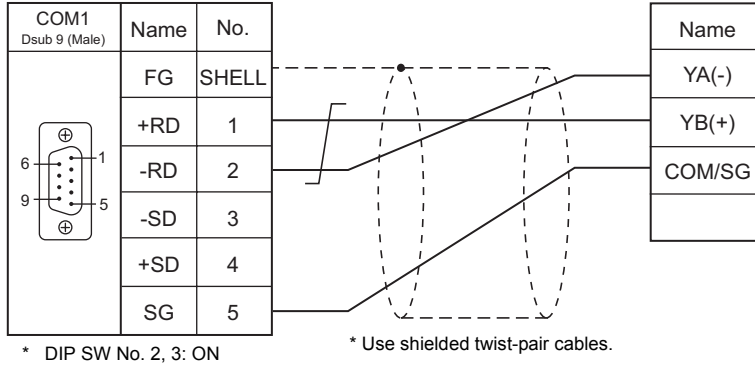

Wiring diagram 2 - COM1

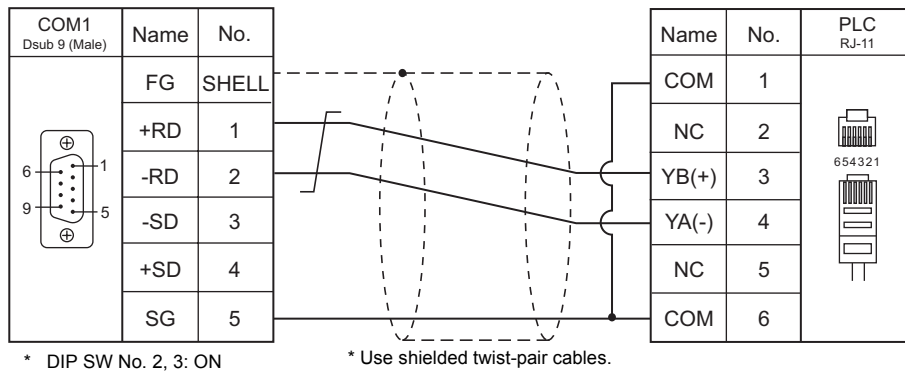

Wiring diagram 3 - COM1

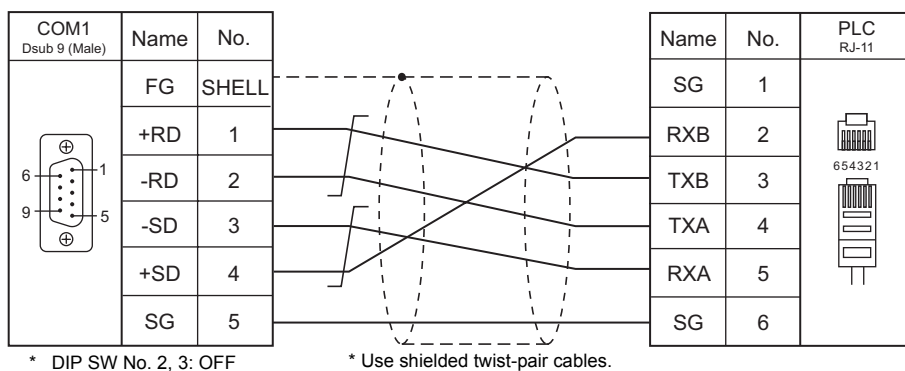

When Connected at COM2:

RS-232C

Wiring diagram 1 - COM2

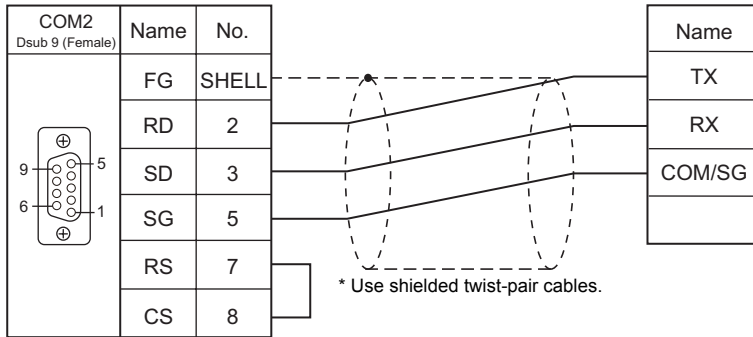

When Connected at COM3:

RS-485

Wiring diagram 1 - COM3

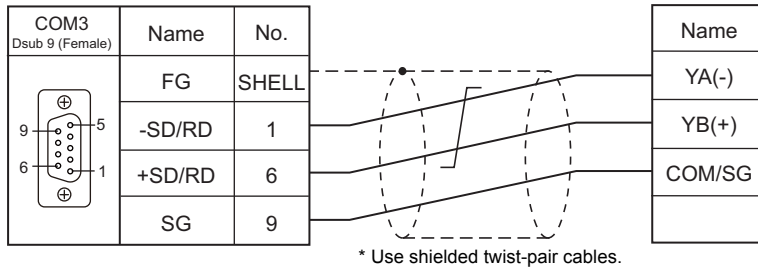

Wiring diagram 2 - COM3

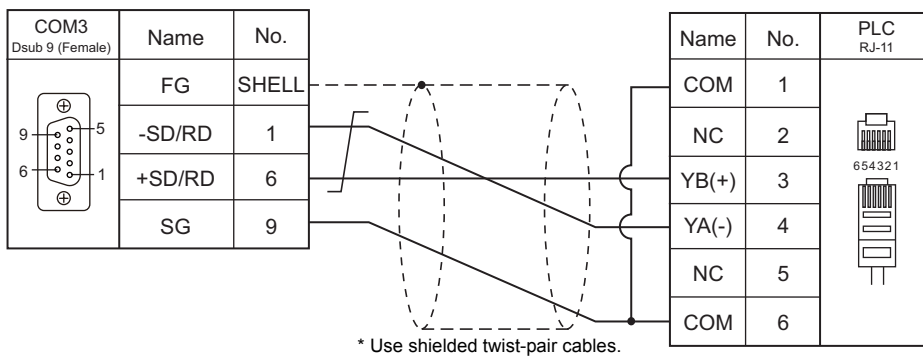

Wiring diagram 3 - COM3

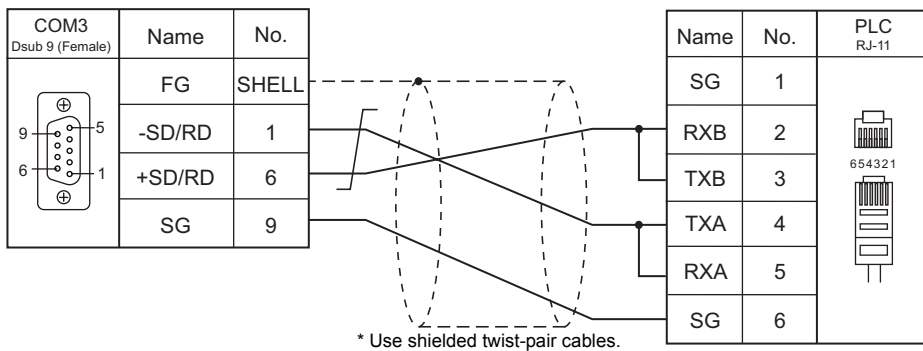

MEMO

Please use this page freely.

42. Siemens

42.1 PLC Connection

42.1 PLC Connection

Serial Connection

PLC Selection on the Editor	CPU	Unit/Port	Signal Level	TS Port	Connection	Ladder Transfer ^{*1}
S5 (PG port)	S5-90U S5-95U S5-95F S5-100U S5-115U S5-115H S5-115F	Programming port of CPU	RS-232C	COM2	Siemens 6ES5 734-1BD20 + Wiring diagram 2 - COM2	×
S7	S7-300	CP-341 (3964R/RK512)	RS-232C	COM2	Wiring diagram 1 - COM2	×
			RS-422	COM1	Wiring diagram 1 - COM1	
	S7-400	CP-441 (3964R/RK512)	RS-232C	COM2	Wiring diagram 1 - COM2	
			RS-422	COM1	Wiring diagram 1 - COM1	
S7-200PPI	CPU 226 CPU 224 CPU 222 CPU 221 CPU 216 CPU 215 CPU 214 CPU 212	PPI	RS-485	COM1	Wiring diagram 2 - COM1	×
S7-300/400MPI	CPU 312 CPU 312C CPU 313C CPU 313C-2 DP CPU 314 CPU 314C-2 DP CPU 315-2 DP CPU 315-2 PN/DP CPU 315F-2 DP CPU 317-2 DP CPU 317-2 PN/DP CPU 317F-2 DP CPU 319-3 PN/DP CPU 412-1 CPU 412-2 CPU 414-2 CPU 414-3 CPU 416-2 CPU 416-3 CPU 417-4	MPI(MPI/DP)	RS-485	COM1	Wiring diagram 2 - COM1	×
TI500/505 series	TI545-1103	Port2	RS-232C	COM2	Wiring diagram 3 - COM2	×
	TI545-1101 TI545-1102 TI545-1104 TI545-1111 TI555-1101 TI555-1102 TI555-1103 TI555-1104 TI555-1105 TI555-1106	Port2	RS-232C	COM2	Wiring diagram 4 - COM2	
			RS-422	COM1	Wiring diagram 3 - COM1	
			RS-485	COM3	Wiring diagram 1 - COM3	
	TI575-2104 TI575-2105 TI575-2106	Port1	RS-232C	COM2	Wiring diagram 5 - COM2	
		Port3	RS-422	COM1	Wiring diagram 4 - COM1	

*1 For the ladder transfer function, see "Appendix 5 Ladder Transfer Function".

Ethernet Connection

PLC Selection on the Editor	CPU	Unit	TCP/IP	UDP/IP	Port No.	Ladder Transfer*1
S7-200 (Ethernet ISOTCP)	CPU222, CPU224 CPU224XP, CPU226	CP243-1 CP243-1 IT	○	×	102 fixed (Max. 8 units)	×
S7-300/400 (Ethernet ISOTCP)	CPU312, CPU312C CPU313, CPU313C-2 DP CPU314, CPU314C-2 DP CPU315-2 DP CPU315-2 PN/DP CPU315F-2 DP CPU317-2 DP CPU317-2 PN/DP CPU317F-2 DP	CP343-1 Lean	○	×	102 (fixed) *2	×
	CPU315-2 PN/DP CPU317-2 PN/DP CPU319-3 PN/DP	-				
	CPU412-1, CPU412-2 CPU414-2, CPU414-3 CPU416-2, CPU416-3 CPU417-4	CP443-1				
S7-300/400 (Ethernet TCP/IP PG protocol)	CPU312, CPU312C CPU313, CPU313C-2 DP CPU314, CPU314C-2 DP CPU315-2 DP CPU315-2 PN/DP CPU315F-2 DP CPU317-2 DP CPU317-2 PN/DP CPU317F-2 DP	CP343-1 Lean	○	×	102 (fixed) *2	×
	CPU315-2 PN/DP CPU317-2 PN/DP CPU319-3 PN/DP	-				
	CPU412-1, CPU412-2 CPU414-2, CPU414-3 CPU416-2, CPU416-3 CPU417-4	CP443-1				
S7-1200 (Ethernet ISOTCP)	CPU1211C CPU1212C CPU1214C	-	○	×	102 (fixed) (Max. 3 units)	×

*1 For the ladder transfer function, see "Appendix 5 Ladder Transfer Function".

*2 In n : 1 connection, the connectable number of TS units varies depending on the system resource capacity of the PLC. Check the capacity on the [Communication] tab window that is displayed by selecting [STEP7 HW configuration] → [CPU] → [Object Properties].

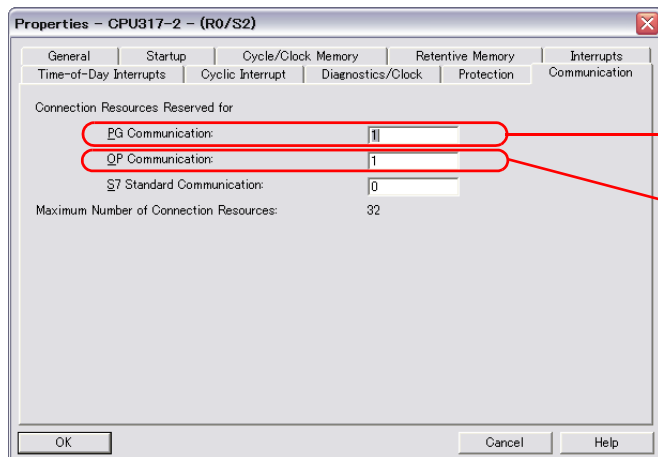

Connectable number of units when the PG protocol is selected (Including connections with STEP 7)

Connectable number of units when ISOTCP is selected (Including the number of OP units of Siemens)

42.1.1 S5 (PG Port)

Communication Setting

Editor

Communication setting

(Underlined setting: default)

Item	Setting	Remarks
Connection Mode	<u>1:1</u> / 1:n / Multi-link2 / Multi-link2 (Ethernet)	
Signal Level	<u>RS-232C</u>	
Baud Rate	<u>9600 bps</u>	
Data Length	<u>8 bits</u>	
Stop Bit	<u>1 bit</u>	
Parity	<u>Even</u>	
Target Port No.	0 to 31	

S5

No particular setting is necessary on S5.

Calendar

This model is not equipped with the calendar function. Use the built-in clock of the TS series.

Available Memory

The available memory setting range varies depending on the PLC model. Be sure to set within the range available for the PLC. Use [TYPE] when assigning the indirect memory for macro programs.

Memory	TYPE	Remarks
DB (Data Block)	00H	*1
I (input)	01H	IW as word device
Q (output)	02H	QW as word device
F (flag/internal relay)	03H	FW as word device
T (timer/current value)	04H	
C (counter/current value)	05H	
AS (absolute address)	06H	

*1 When these memory are used, registration is required at the PLC.
For more information, refer to the PLC manual issued by the manufacturer.
The assigned memory is indicated when editing the screen as shown on the right.
Devices that can be set on TS series range from DB000000 to DB255255.

Example: DB001000

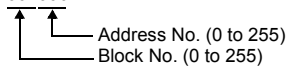

Indirect Memory Designation

	15	8 7	0
n+0	Model		Memory type
n+1	Address No. (word designation)		
n+2	00	Bit designation	
n+3	00	Station number	

- Designation of addresses for byte devices (I, Q, F, AS):
Specify an address number divided by "2" for "n+1".

Example: Indirect memory designation of "IW00010"
 $n+1 = 10 \text{ (DEC)} \div 2 = 5 \text{ (DEC)}$
- Bit designation of addresses for byte devices (I, Q, F, AS):
 - An even address number
Specify a byte address number divided by "2" for "n+1" and specify a bit number for "n+2".
Example: Indirect memory designation of "I000105"
 $n + 1 = 10 \div 2 = 5 \text{ (DEC)}$
 $n + 2 = 5 \text{ (DEC)}$
 - An odd address number
Specify a byte address number minus "1", divided by "2", for "n+1". Specify a bit number plus "8" for "n+2".
Example: Indirect memory designation of "I000115"
 $n + 1 = (11 - 1) \div 2 = 5 \text{ (DEC)}$
 $n + 2 = 5 + 8 = 13 \text{ (DEC)}$
- For DB device:
Specify a block number for the higher-order bytes "n+1". Specify an address number for the lower-order bytes.

42.1.2 S7

Communication Setting

Editor

Communication setting

(Underlined setting: default)

Item	Setting	Remarks
Connection Mode	<u>1</u> : 1 / Multi-link2	
Signal Level	<u>RS-232C</u> / RS-422/485	
Baud Rate	4800 / <u>9600</u> / 19200 / 38400 / 57600 / 76800 / 115K bps	
Data Length	7 / <u>8</u> bits	
Stop Bit	<u>1</u> / 2 bit	
Parity	None / Odd / <u>Even</u>	

S7

Make the setting for communication using the ladder tool "SIMATIC Manager". For more information, refer to the PLC manual issued by the manufacturer.

Hardware Configuration ([RK 512] tab window)

Open the [Protocol] dialog and specify the baud rate and the parity, etc. in the [RK 512] tab window.

Hardware Configuration ([Interface] tab window)

Specify "None" for the initial state of the receive line in the [Interface] tab window.

Available Memory

The available memory setting range varies depending on the PLC model. Be sure to set within the range available for the PLC. Use [TYPE] when assigning the indirect memory for macro programs.

Memory	TYPE	Remarks
DB (data block)	00H	*1
I (input)	01H	IW as word device
Q (output)	02H	QW as word device
M (memory word)	03H	MW as word device
T (timer/current value)	04H	
C (counter/current value)	05H	

*1 When this memory is used, a registration is required for the PLC.
For more information, refer to the PLC manual issued by the manufacturer.
The assigned memory is indicated when editing the screen as shown on the right.
The address range available on TS series is DB255:0000 to DB255:0510.

Example: DB001 : 0000

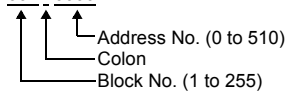

42.1.3 S7-200PPI

Communication Setting

* Only the logical port PLC1 can be selected for S7-200PPI.

Editor

Communication setting

(Underlined setting: default)

Item	Setting	Remarks
Connection Mode	<u>1</u> : 1 / 1 : n / Multi-link2	
Signal Level	RS-422/485	
Baud Rate	<u>9600</u> / 19200 / 187.5k ^{*1} bps	187.5 Kbps enabled with COM1 selected for PLC1
Data Length	8 bits	
Stop Bit	1 bit	
Parity	Even	
Target Port No.	1 to 31 (<u>2</u>)	

*1 Notes on communication at the baud rate of 187.5 kbps:

- When performing slave communication via RS-485 using PLC2 - PLC8, set the transmission delay time to 5 msec or longer.
- When performing serial communication with another device at PLC2 to PLC8, if only one port is used, 115-kbps communication is available.
When two ports are used at the same time, the maximum baud rate available is 57600 bps for each port.

Terminating resistance

When the TS series is located at the terminal, set DIP switches 4, 5 and 7 on its back to ON. Communications may not take place normally without terminal resistance setting.

S7-200

Make the setting for communication using the ladder tool "STEP 7 MicroWIN".

System block

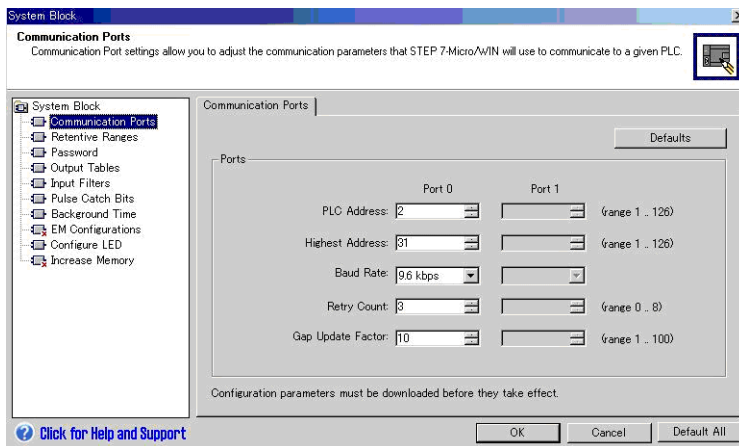

(Underlined setting: default)

Item	Setting	Remarks
PLC Address	1 to 31 (<u>2</u>)	Numbers from 1 to 126 can be specified, however, communication with TS cannot be established when a number from 32 to 126 is specified.
Highest Address	1 to <u>31</u>	
Baud Rate	<u>9.6k</u> / 19.2k / 187.5 kbps	

The following settings are fixed; data length: 8 bits, stop bit: 1 bit and parity: even.

Available Memory

The available memory setting range varies depending on the PLC model. Be sure to set within the range available for the PLC. Use [TYPE] when assigning the indirect memory for macro programs.

Memory	TYPE	Remarks
V (data memory)	00H	VW as word device
I (input)	01H	IW as word device, possible to write to the unused area
Q (output)	02H	QW as word device
M (bit memory/internal relay)	03H	MW as word device
T (timer/current value)	04H	
C (counter/current value)	05H	
HC (high-speed counter/current value)	08H	Double-word usable
AIW (analog input)	09H	
AQW (analog output)	0AH	
SM (special memory/special relay)	0BH	SMW as word device
S (stage)	0CH	SW as word device

42.1.4 S7-200(Ethernet ISOTCP)

Communication Setting

Editor

Make the following settings on the editor. For more information, see Appendix 2 Ethernet.

- IP address for the TS unit
 - When specified on the screen data:
[System Setting] → [Ethernet Communication] → [Local Port IP Address]
 - When specified on the TS unit:
Main Menu screen → [Ethernet]
- Port number for the TS unit (for communication with PLC)
[System Setting] → [Device Connection Setting] → [Communication Setting]
- IP address and port number (No. 102) of the PLC
[System Setting] → [Device Connection Setting] → [PLC Table]

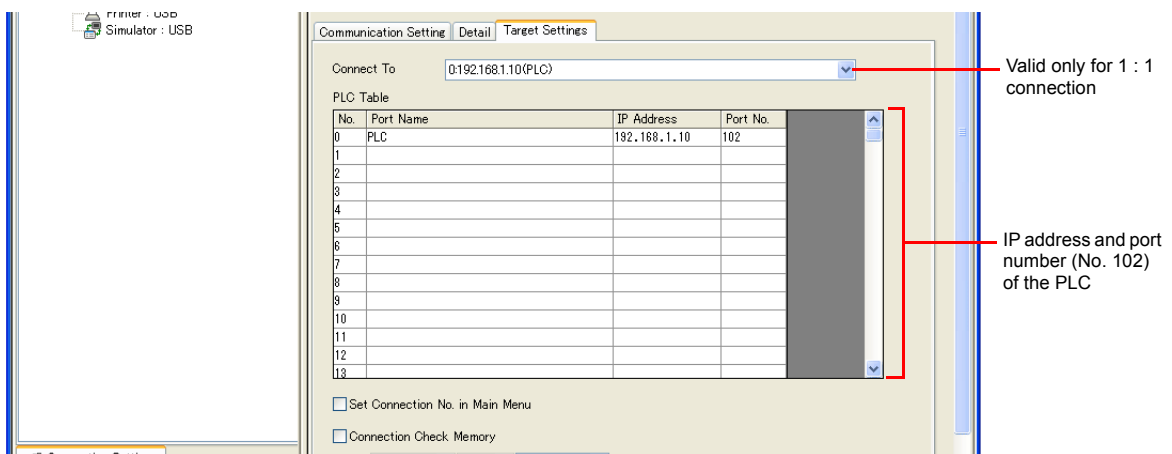

- Others
[System Setting] → [Device Connection Setting] → [Communication Setting] → [Module Position/Connection No. Setting]
 - Unchecked (default)
The module position and connection number will automatically be retrieved.
 - Checked
Set module positions and connection numbers in the [PLC Table] in the [Target Settings] tab window ([System Setting] → [Device Connection Setting]).
Setting range: [Module Position] 0 to 6 [Connection No.] 0 to 7

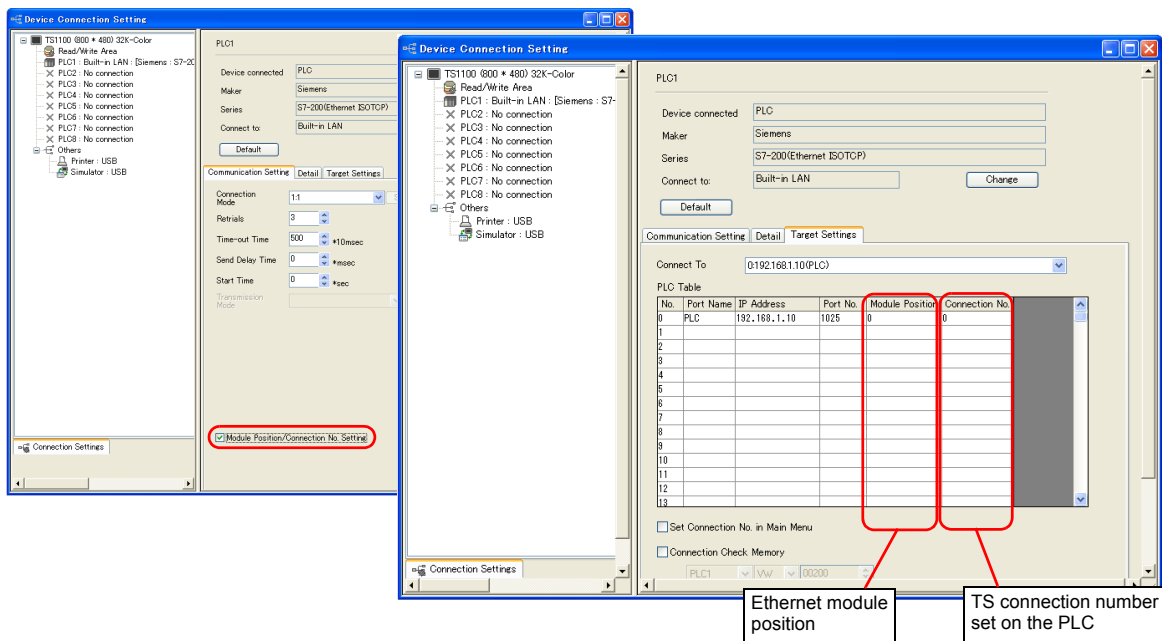

S7-200

Make the following settings in the ladder tool “STEP 7-Micro/WIN”.

“ETH0_CTRL” must be executed in the ladder program at each time of scan. For more information, refer to the PLC manual issued by the manufacturer.

Ethernet Wizard

Set the following items including module position, TS connection number, IP address, and subnet mask according to the instructions in Ethernet Wizard.

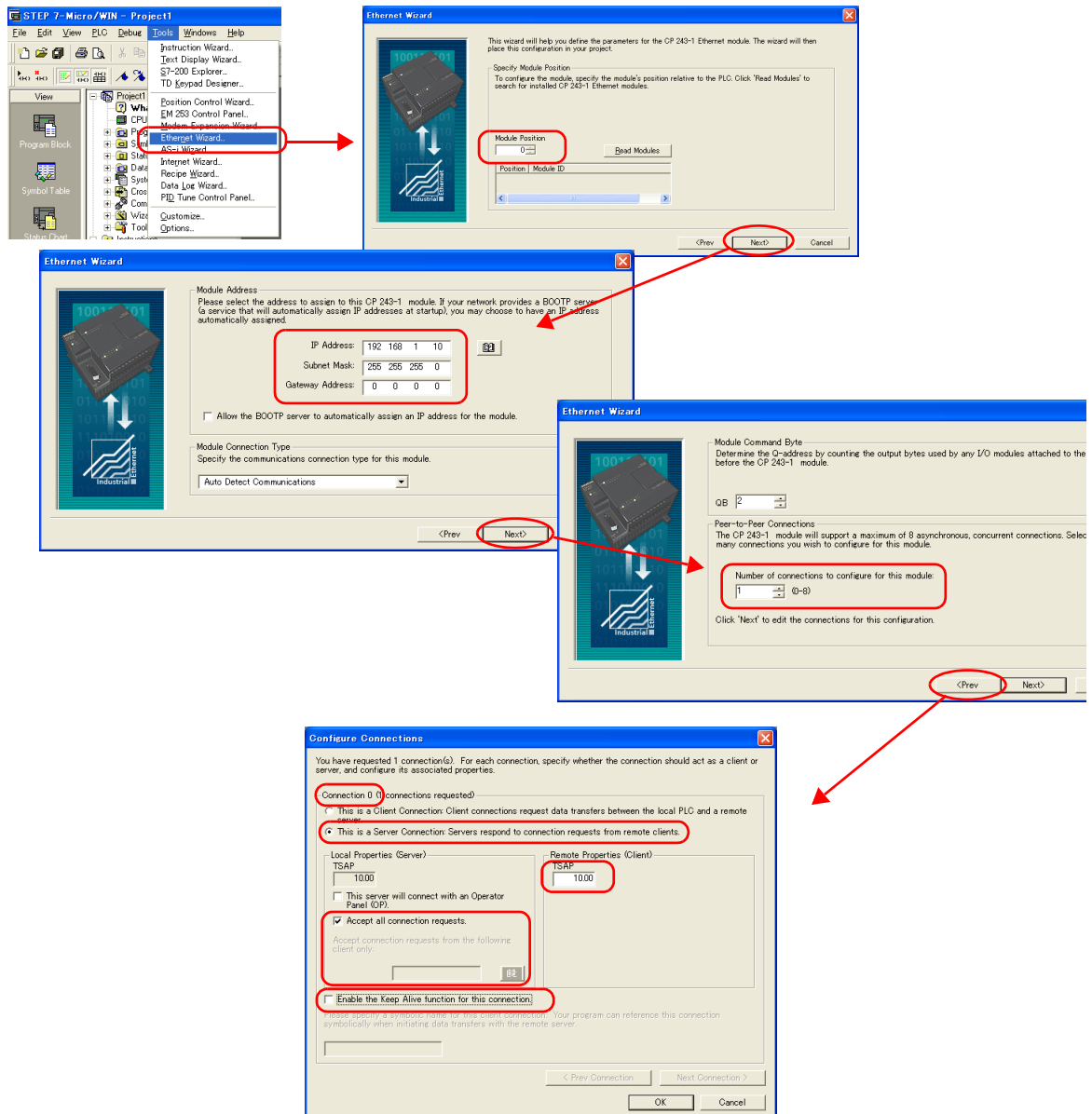

Item	Setting	Remarks	
Module Position	0 to 6	Set this value for [Module Position] in V-SFT.	
IP Address	Set the IP address of the PLC.		
Subnet Mask	Specify according to the environment.		
Gateway Address			
Number of connections to configure for this module	0 to 8	Number of connecting units	
Configure Connections	Connection No.	0 to 7	Automatically displayed according to [Number of connections to configure for this module] Set this value for [Connection No.] in V-SFT.
	This is a Server Connection	Checked	
	Accept all connection requests	Checked	Unchecked: Specify the IP address of TS for [Accept connection requests from the following client only].
	Enable the Keep Alive function for this connection.	Unchecked	
Remote Propaties (Client) TSAP	10.00		

Calendar

The TS series cannot read the calendar data from this PLC. Use the built-in clock of the TS series.

Available Memory

The available memory setting range varies depending on the PLC model. Be sure to set within the range available for the PLC. Use [TYPE] when assigning the indirect memory for macro programs.

Memory	TYPE	Remarks
V (data memory)	00H	VW as word device
I (input)	01H	IW as word device
Q (output)	02H	QW as word device
M (bit memory/internal relay)	03H	MW as word device
T (timer/current value)	04H	
C (counter/current value)	05H	

42.1.5 S7-300/400MPI

Communication Setting

* Only the logical port PLC1 can be selected for S7-300/400MPI.

Editor

Communication setting

(Underlined setting: default)

Item	Setting	Remarks
Connection Mode	<u>1:1</u> / 1 : n	A maximum of four MPI-capable units can be connected.
Signal Level	RS-422/485	
Baud Rate	<u>19200</u> / 187.5k ⁻¹ bps	187.5 Kbps enabled with COM1 selected for PLC1
Data Length	8 bits	
Stop Bit	1 bit	
Parity	Even	
Target Port No.	0 to 31 (<u>2</u>)	Specify the MPI station number of S7-300/400.

*1 Notes on communication at the baud rate of 187.5 kbps:

- When performing slave communication via RS-485 using PLC2 - PLC8, set the transmission delay time to 5 msec or longer.
- When performing serial communication with another device at PLC2 to PLC8, if only one port is used, 115-kbps communication is available.
When two ports are used at the same time, the maximum baud rate available is 57600 bps for each port.

MPI setting

(Underlined setting: default)

Item	Setting	Remarks
Highest MPI Address	<u>15</u> / 31 / 63 / 126	Specify the highest address in the MPI network.
Local Port No.	0 to 126 (<u>3</u>)	Specify the port number of TS. It must be a unique number.

Terminating resistance

When the TS series is located at the terminal, set DIP switches 4, 5 and 7 on its back to ON. Communications may not take place normally without terminal resistance setting.

S7-300/400MPI

Specify the MPI address and the baud rate using "SIMATIC Manager". For more information, refer to the PLC manual issued by the manufacturer.

Available Memory

The available memory setting range varies depending on the PLC model. Be sure to set within the range available for the PLC. Use [TYPE] when assigning the indirect memory for macro programs.

Memory	TYPE	Remarks
DB (data block)	00H	*1
I (input)	01H	IW as word device
Q (output)	02H	QW as word device
M (memory word)	03H	MW as word device
T (timer/current value)	04H	
C (counter/current value)	05H	

*1 When this memory is used, a registration is required for the PLC.
For more information, refer to the PLC manual issued by the manufacturer.
The assigned memory is indicated when editing the screen as shown on the right.
The address range available on TS series is DB0001:0000 to DB4095:8190.

Example: DB0001 : 0000

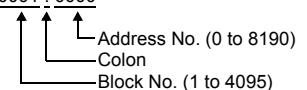

Indirect Memory Designation

- DB device

	15	8 7	0
n + 0	9x (x = 1 to 8)		00
n + 1	Block number	Address number (word designation)	
n + 2	00		Block number
n + 3	Expansion code		Bit designation
n + 4	00		Station number

42.1.6 S7-300/400 (Ethernet ISOTCP)

Communication Setting

Editor

Make the following settings on the editor. For more information, see “Appendix 2 Ethernet”.

- IP address for the TS unit
 - When specified on the screen data:
[System Setting] → [Ethernet Communication] → [Local Port IP Address]
 - When specified on the TS unit
Main Menu screen → [Ethernet]
- Port number for the TS unit (for communication with PLC)
[System Setting] → [Device Connection Setting] → [Communication Setting]
- Others
[System Setting] → [Device Connection Setting] → [Communication Setting] → [CPU Slot No. Setting]
 - When unchecked:
The slot number is automatically retrieved.
 - When checked:
Set the slot number. Setting range: 2 to 18

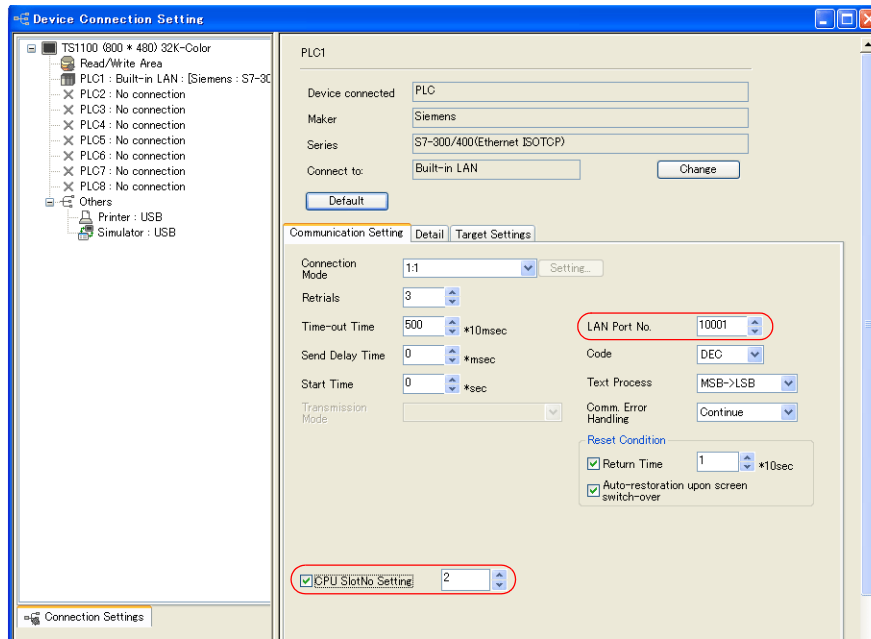

- IP address and port number (No. 102) of the PLC
[System Setting] → [Device Connection Setting] → [PLC Table]

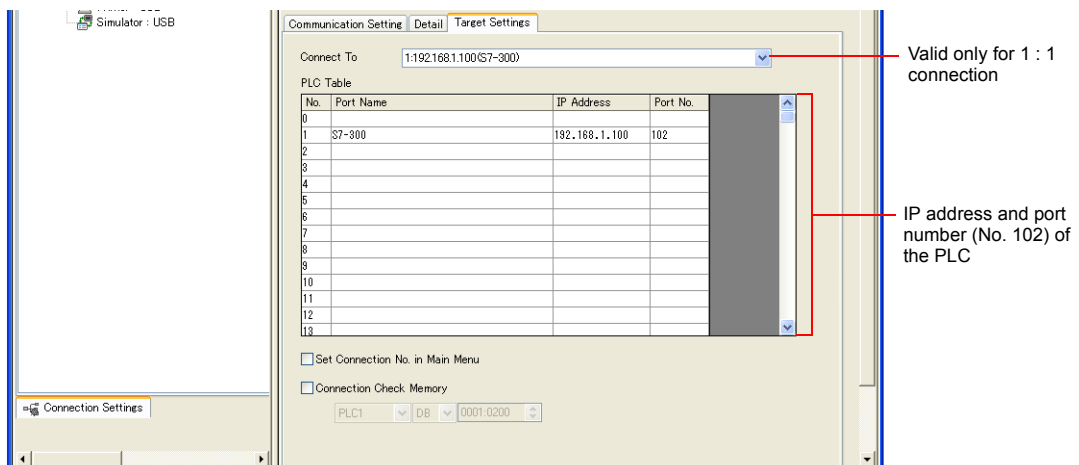

S7-300/400

Make the communication settings using "SIMATIC Manager". For more information, refer to the PLC manual issued by the manufacturer.

Hardware Configuration

Specify the IP address on the Ethernet interface PN-IO screen.

Available Memory

The available memory setting range varies depending on the PLC model. Be sure to set within the range available for the PLC. Use [TYPE] when assigning the indirect memory for macro programs.

Memory	TYPE	Remarks
DB (data block)	00H	*1
I (input)	01H	IW as word device
Q (output)	02H	QW as word device
M (memory word)	03H	MW as word device
T (timer/current value)	04H	
C (counter/current value)	05H	

*1 When this memory is used, a registration is required for the PLC. For more information, refer to the PLC manual issued by the manufacturer. The assigned memory is indicated when editing the screen as shown on the right. The address range available on TS series is DB0001:0000 to DB4095:8190.

Example: DB0001 : 0000

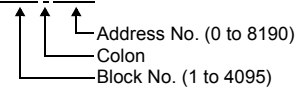

Indirect Memory Designation

- DB device

	15	8	7	0
n + 0	9x (x = 1 to 8)		00	
n + 1	Block number (Lower 4 bits)		Address number (word designation)	
n + 2	00		Block number (higher 8 bits)	
n + 3	Expansion code		Bit designation	
n + 4	00		Station number	

42.1.7 S7-300/400 (Ethernet TCP/IP PG Protocol)

Communication Setting

Editor

Make the following settings on the editor. For more information, see “Appendix 2 Ethernet”.

- IP address for the TS unit
 - When specified on the screen data:
[System Setting] → [Ethernet Communication] → [Local Port IP Address]
 - When specified on the TS unit
Main Menu screen → [Ethernet]
- Port number for the TS unit (for communication with PLC)
[System Setting] → [Device Connection Setting] → [Communication Setting]

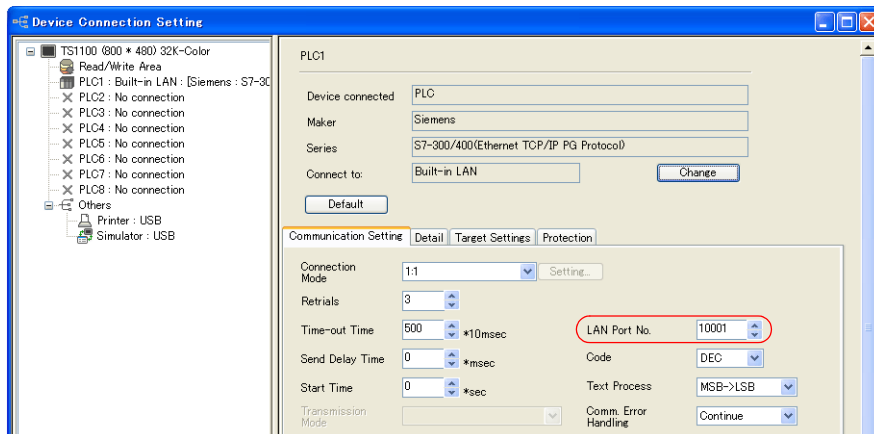

- Other
[System Setting] → [Device Connection Setting] → [Protection]
If the protection function is used on STEP7, set a password. Otherwise, a communication error will occur.

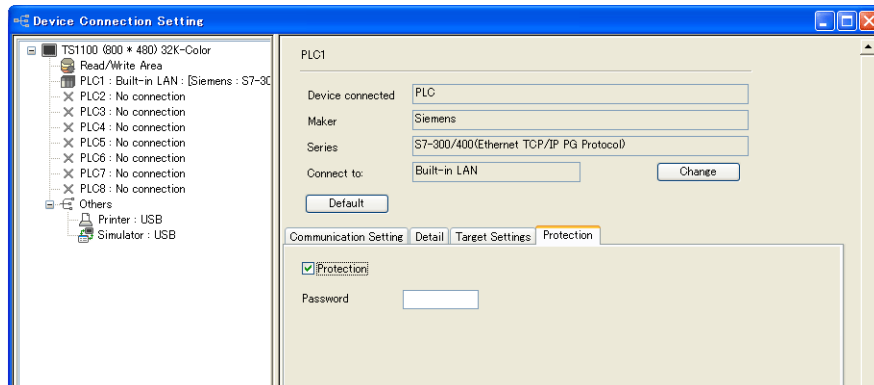

- IP address and port number (No. 102) of the PLC
[System Setting] → [Device Connection Setting] → [PLC Table]

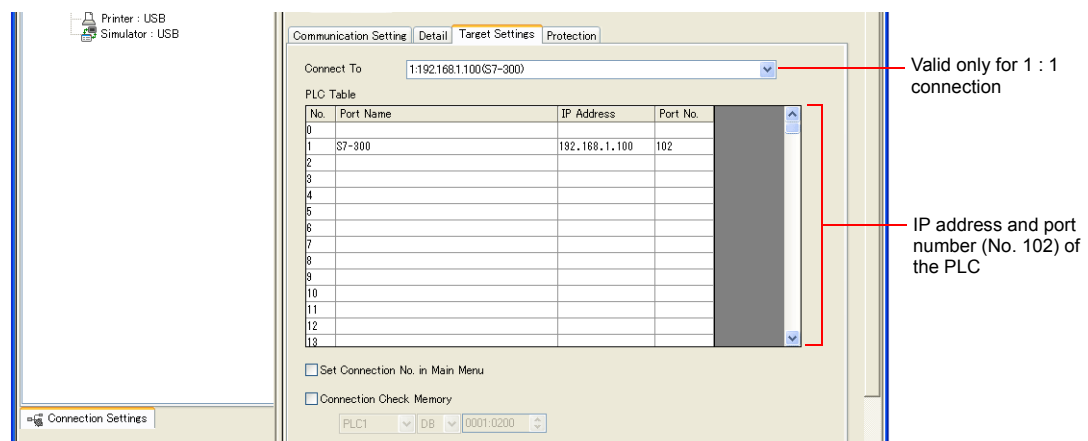

S7-300/400

Make the communication settings using "SIMATIC Manager". For more information, refer to the PLC manual issued by the manufacturer.

Hardware Configuration

Specify the IP address on the Ethernet interface PN-IO screen.

Available Memory

The available memory setting range varies depending on the PLC model. Be sure to set within the range available for the PLC. Use [TYPE] when assigning the indirect memory for macro programs.

Memory	TYPE	Remarks
DB (data block)	00H	*1
I (input)	01H	IW as word device
Q (output)	02H	QW as word device
M (memory word)	03H	MW as word device
T (timer/current value)	04H	
C (counter/current value)	05H	

*1 When this memory is used, a registration is required for the PLC. For more information, refer to the PLC manual issued by the manufacturer. The assigned memory is indicated when editing the screen as shown on the right. The address range available on TS series is DB0001:0000 to DB4095:8190.

Example: DB0001 : 0000

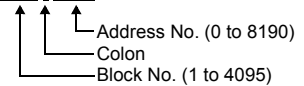

Indirect Memory Designation

- DB device

	15	8 7	0
n + 0	9x (x = 1 to 8)		00
n + 1	Block number (Lower 4 bits)	Address number (word designation)	
n + 2	00		Block number (higher 8 bits)
n + 3	Expansion code		Bit designation
n + 4	00		Station number

42.1.8 S7-1200 (Ethernet ISOTCP)

Communication Setting

Editor

Make the following settings on the editor. For more information, see “Appendix 2 Ethernet”.

- IP address for the TS unit
 - When specified on the screen data:
[System Setting] → [Ethernet Communication] → [Local Port IP Address]
 - When specified on the TS unit:
Main Menu screen → [Ethernet]
- Port number for the TS unit (for communication with PLC)
[System Setting] → [Device Connection Setting] → [Communication Setting]
- Others
[System Setting] → [Device Connection Setting] → [Communication Setting] → [CPU Slot No. Setting]
 - Unchecked (default)
The slot number is automatically retrieved.
 - Checked
Set the slot number. Setting range: 0 to 18

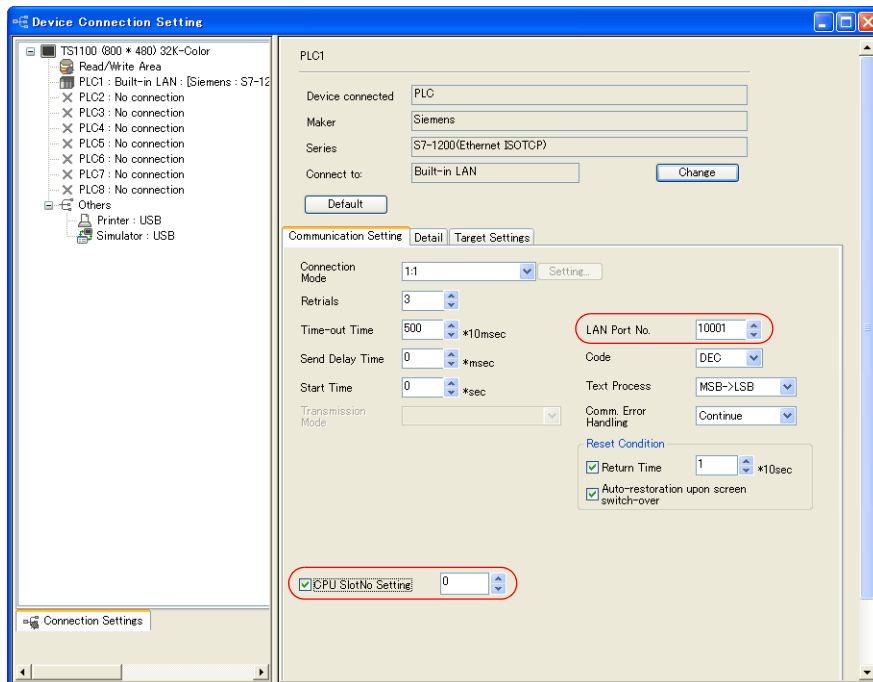

- IP address and port number (No. 102) of the PLC
[System Setting] → [Device Connection Setting] → [PLC Table]

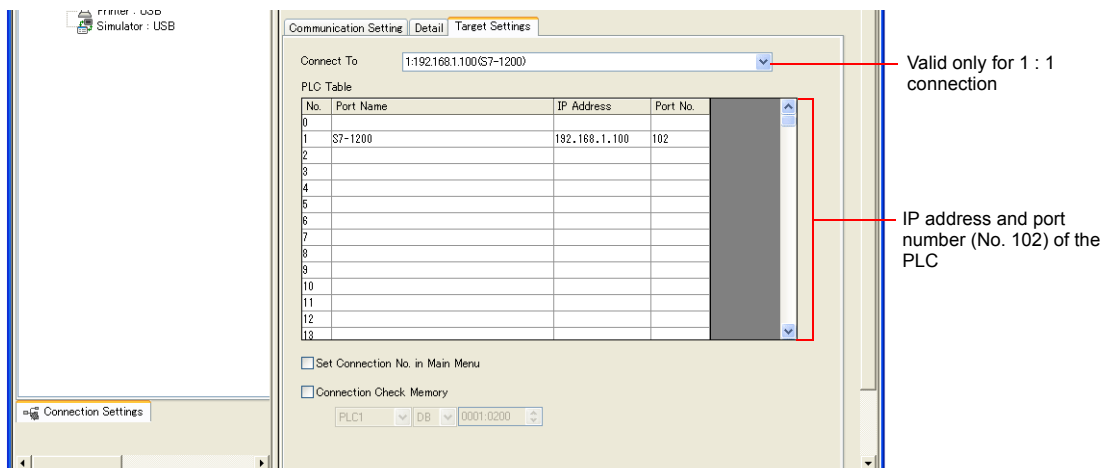

S7-1200

Make the settings using "Totally Integrated Automation Portal V10" dedicated to S7-1200. For more information, refer to the PLC manual issued by the manufacturer.

IP address setting

1. Select "PLC_1" in [Network view] or [Device view] in the project.
2. Set the IP address in [Ethernet addresses] ([Properties] → [PROFINET interface]).

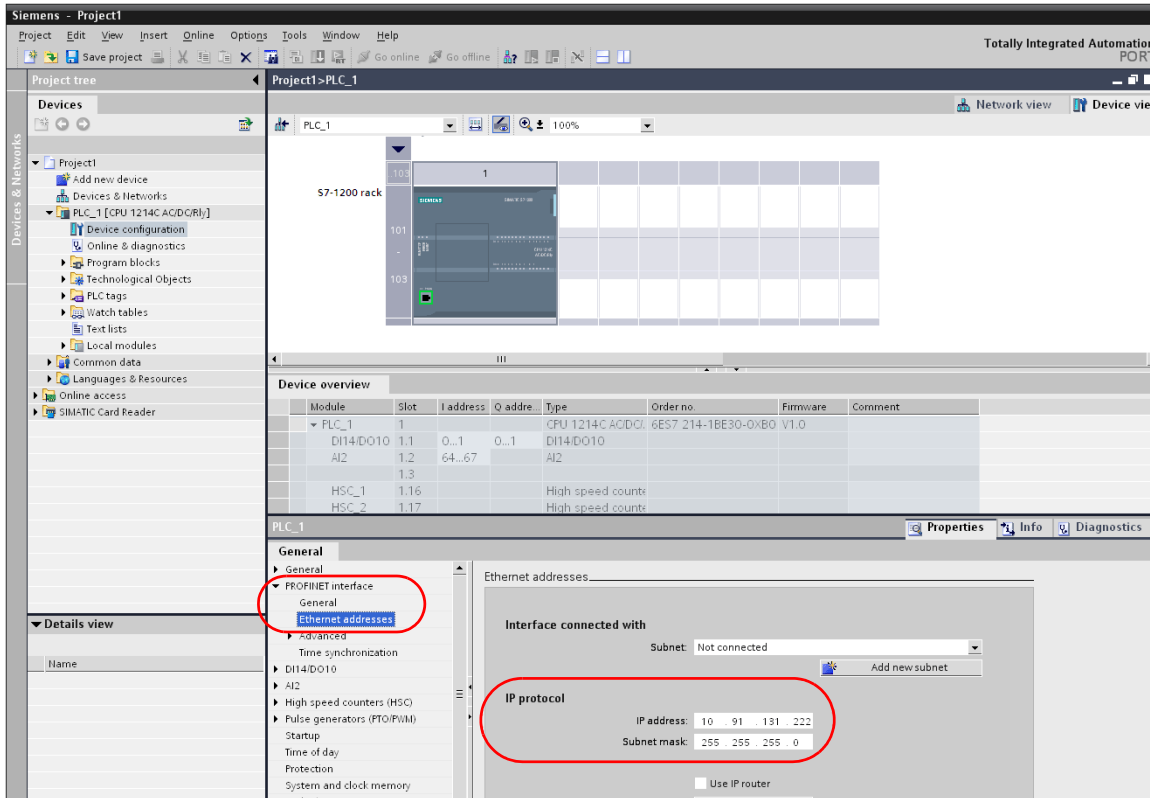

3. Click [Online] → [Download to device] or [Extended Download to device] to display the [Extended download to device] dialog.

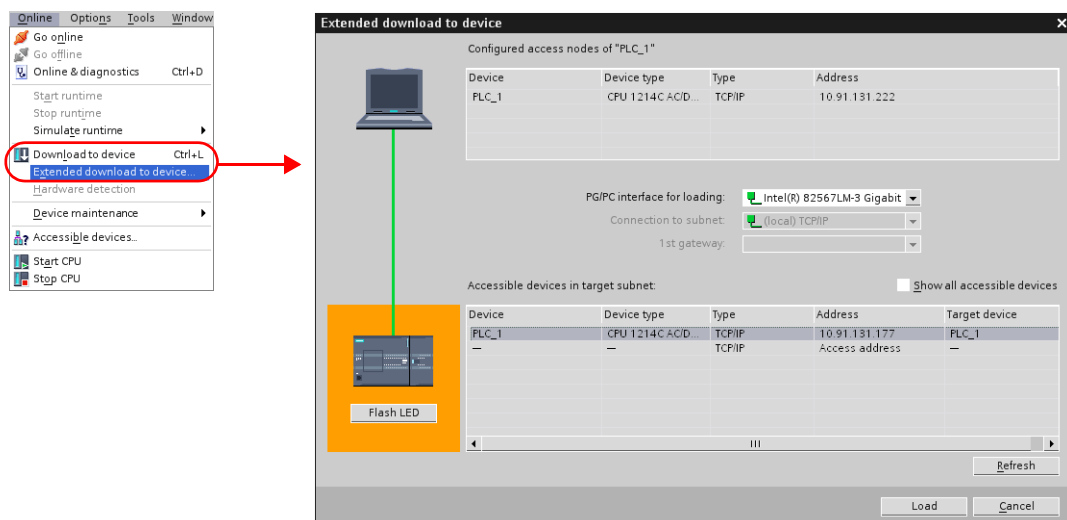

4. Select [Access Address] and click [Load].

5. The [Load preview] screen is displayed. Click [Load].

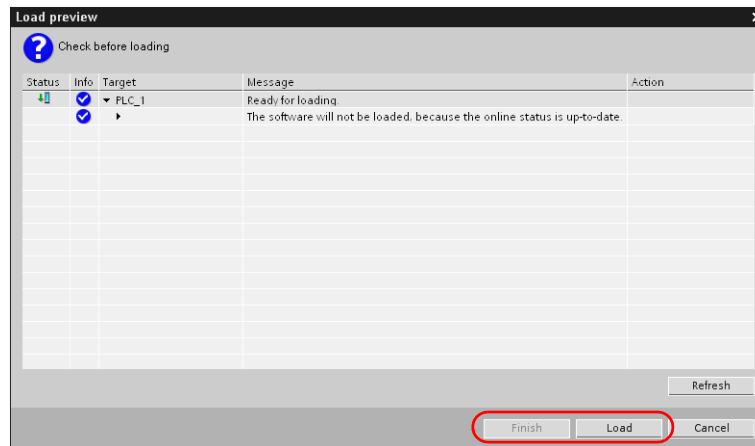

6. Click [Finish]. The IP address setting has been completed.

DB area setting

The following settings are required to use the DB memory.

1. Select [Program blocks] → [Add new block] in the project, and make the following settings.

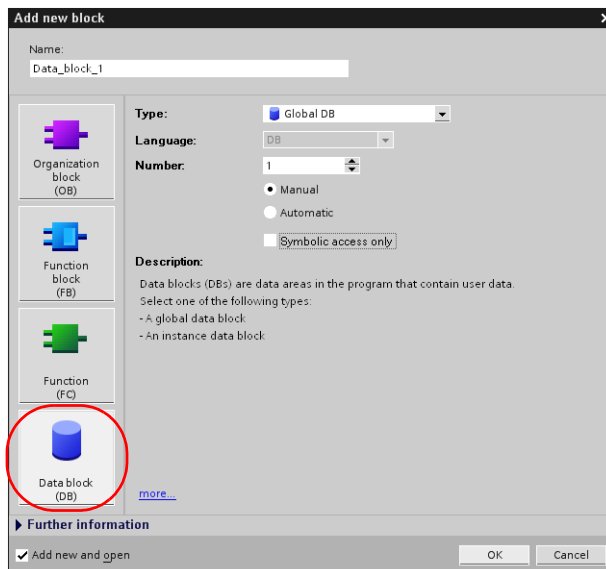

	Item	Setting
Data block	Number	Set the block number in the range from 1 to 4095.
	Manual / Automatic	Manual
	<input type="checkbox"/> Symbolic access only	Unchecked

2. The newly created data block is added under [Program blocks] in the project.

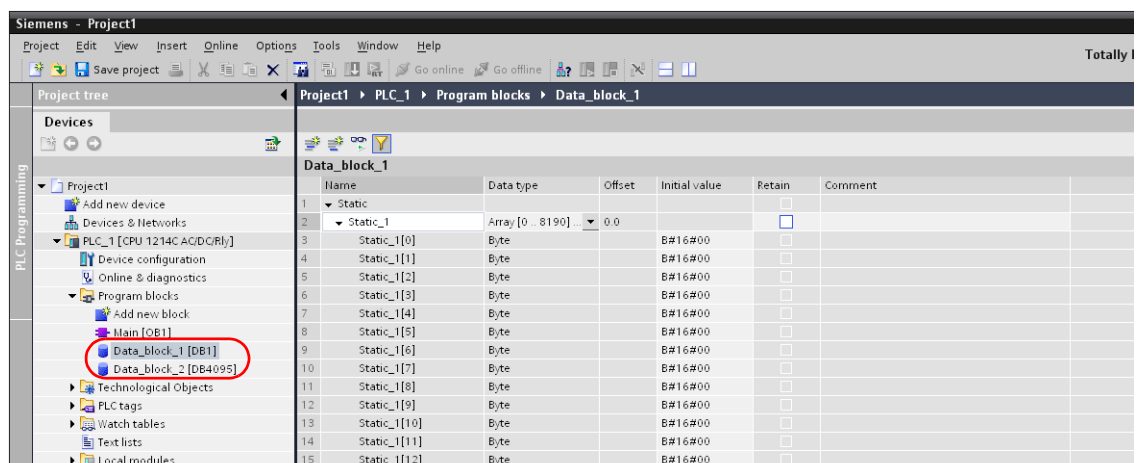

- When specifying the byte address in the array format: Select "Array [lo..hi] of type" for "Data type" and enter "lo", "hi" and "type" (byte).
Range of "lo" and "hi": 0 to 8190

Example: Array [0..1024] of type

- From the right-click menu of [Project tree], select [Download to device] → [software] to write the settings into the PLC.

Available Memory

The available memory setting range varies depending on the PLC model. Be sure to set within the range available for the PLC. Use [TYPE] when assigning the indirect memory for macro programs.

Memory	TYPE	Remarks
DB (data block)	00H	*1
I (input)	01H	IW as word device
Q (output)	02H	QW as word device
M (memory word)	03H	MW as word device

*1 When this memory is used, a registration is required for the PLC.
For more information, refer to the PLC manual issued by the manufacturer.
The assigned memory is indicated when editing the screen as shown on the right.
The address range available on TS series is DB0001:0000 to DB4095:8190.

Example: DB0001 : 0000

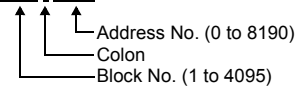

Indirect Memory Designation

- DB device

	15	8 7	0
n + 0	9x (x = 1 to 8)		00
n + 1	Block No. (lower 4 bits)	Address No. (word designation)	
n + 2	00		Block No. (higher 8 bits)
n + 3	Expansion code		Bit designation
n + 4	00		Station number

42.1.9 TI500 / 505 Series

Communication Setting

Editor

Communication setting

(Underlined setting: default)

Item	Setting	Remarks
Connection Mode	<u>1</u> : 1 / 1 : n / Multi-link2 / Multi-link2 (Ethernet)	
Signal Level	<u>RS-232C</u> / RS-422/485	
Baud Rate	9600 / <u>19200</u> / 38400 / 57600 / 115200 bps	
Data Length	7 / <u>8</u> bits	
Stop Bit	<u>1</u> / 2 bits	
Parity	<u>None</u> / Odd / Even	
Target Port No.	0 to 31	

PLC

TI545/TI555

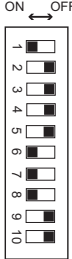
Item	No.	Setting	Remarks																								
	1	Port 2 signal level	ON: RS-232C / RS-422 OFF: RS-485																								
	6	Port 2 Baud rate	<table border="1"> <thead> <tr> <th>Baud Rate</th> <th>6</th> <th>7</th> <th>8</th> </tr> </thead> <tbody> <tr> <td>115200 *</td> <td>ON</td> <td>ON</td> <td>OFF</td> </tr> <tr> <td>57600 *</td> <td>ON</td> <td>OFF</td> <td>ON</td> </tr> <tr> <td>38400</td> <td>ON</td> <td>OFF</td> <td>OFF</td> </tr> <tr> <td>19200</td> <td>ON</td> <td>ON</td> <td>ON</td> </tr> <tr> <td>9600</td> <td>OFF</td> <td>ON</td> <td>ON</td> </tr> </tbody> </table>	Baud Rate	6	7	8	115200 *	ON	ON	OFF	57600 *	ON	OFF	ON	38400	ON	OFF	OFF	19200	ON	ON	ON	9600	OFF	ON	ON
	Baud Rate			6	7	8																					
	115200 *			ON	ON	OFF																					
57600 *	ON	OFF	ON																								
38400	ON	OFF	OFF																								
19200	ON	ON	ON																								
9600	OFF	ON	ON																								
7																											
8																											
			Only RS-232C supported by 555-1103CPU *Supported by 555-1105CPU and 555-1106CPU only																								

TI575

Item	Setting	Remarks
Baud rate	9600	
Data length	7 bits	
Parity	Odd	
Stop bit	1 bit	

Available Memory

The available memory setting range varies depending on the PLC model. Be sure to set within the range available for the PLC. Use [TYPE] when assigning the indirect memory for macro programs.

Memory	TYPE	Remarks
V (variable memory)	00H	
WX (word input)	01H	
WY (word output)	02H	
X (discrete input)	03H	
Y (discrete output)	04H	
CR (control relay)	05H	
TCP (timer, counter/set value)	06H	
TCC (timer, counter/current value)	07H	
DCP (drum count/set value)	08H	
DCC (drum count/current value)	09H	Read only
DSP (drum step/set value)	0AH	
DSC (drum step/current value)	0BH	
K (constant memory)	0CH	
STW (system status)	0DH	

Indirect Memory Designation

	15	8 7	0
n+0	Model		Memory type
n+1	Address No. (word designation)		
n+2	Expansion code		Bit designation
n+3	00		Station number

- Specify the value obtained by subtracting "1" from the actual memory address for the memory address number.
- For the designation of a DCC device, specify a drum step number minus "1" for the expansion code.

42.1.10 Wiring Diagrams

We recommend the following cable and the connectors for cable configuration. For more information, refer to related documents issued by Siemens.

- Recommended cable

Manufacturer	Model
Siemens	6XV1 830-0EH10

- Recommended connector

Manufacturer	Model	Remarks	
Siemens	6ES7 972-0BA50-0XA0	Fast Connect	For vertical wiring 90-degree angle of outgoing cable
	6ES7 972-0BB50-0XA0		Without PG I/F
	6ES7 972-0BA60-0XA0		With PG I/F
	6ES7 972-0BB60-0XA0		For vertical wiring 35-degree angle of outgoing cable
	6GK1 500-0FC00		For horizontal wiring
			Without PG I/F
			With PG I/F
			-

When Connected at COM1:

RS-422/RS-485

Wiring diagram 1 - COM1

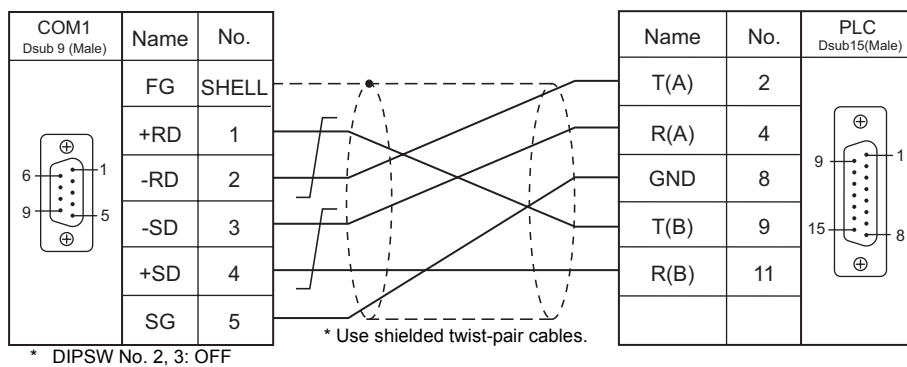

Wiring diagram 2 - COM1

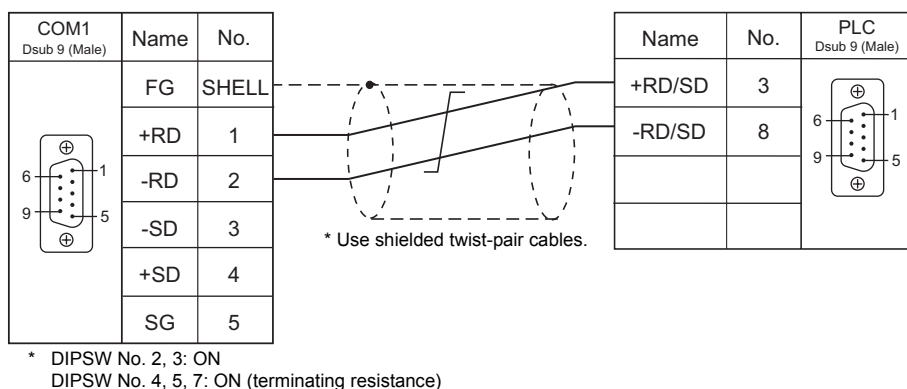

Wiring diagram 3 - COM1

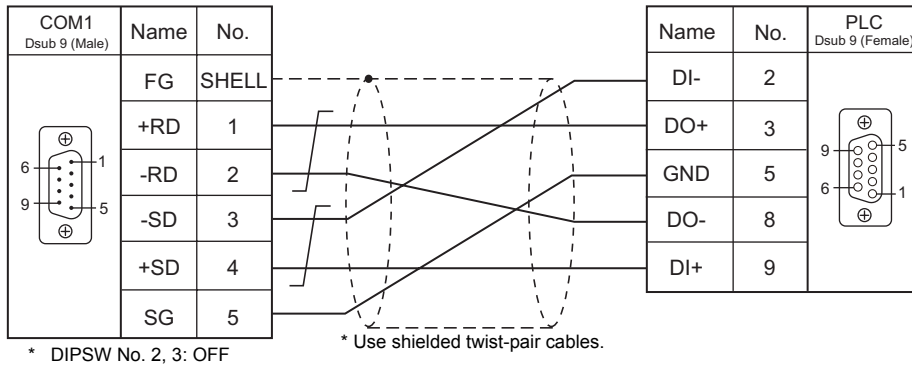

Wiring diagram 4 - COM1

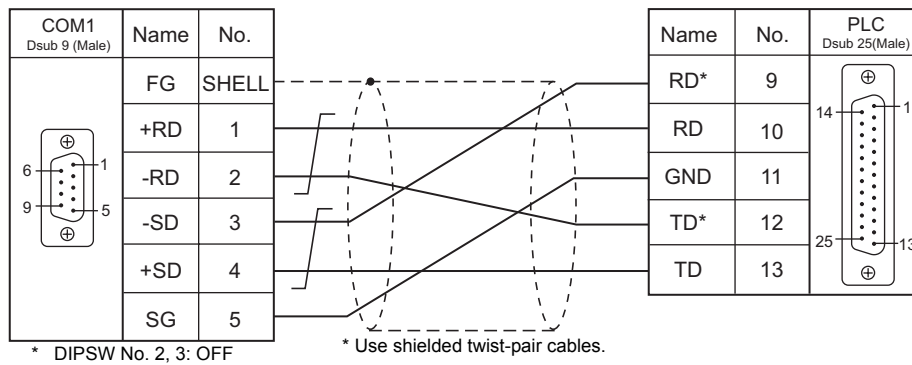

When Connected at COM2:

RS-232C

Wiring diagram 1 - COM2

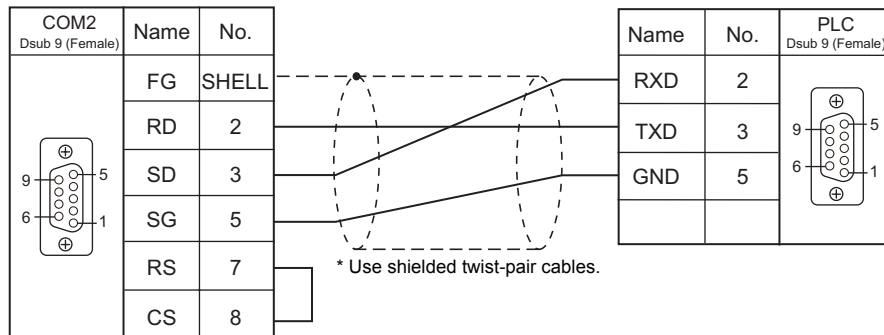

Wiring diagram 2 - COM2

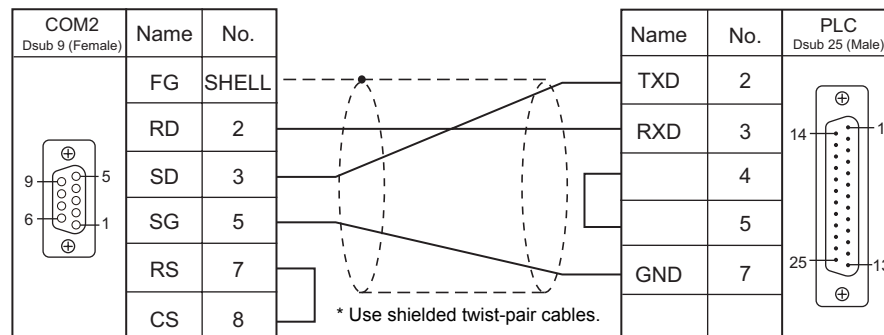

Wiring diagram 3 - COM2

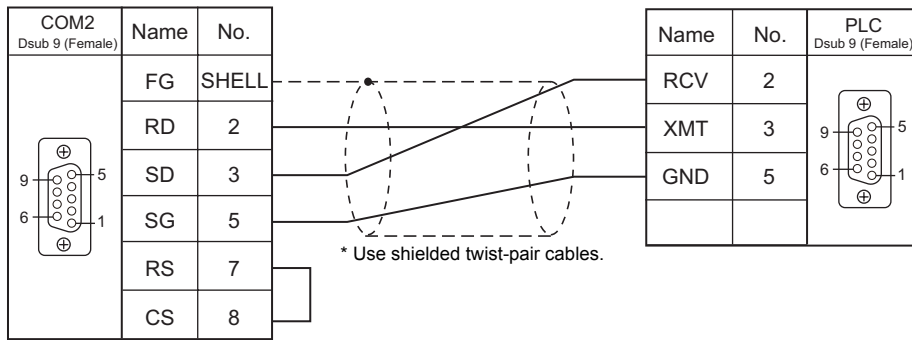

Wiring diagram 4 - COM2

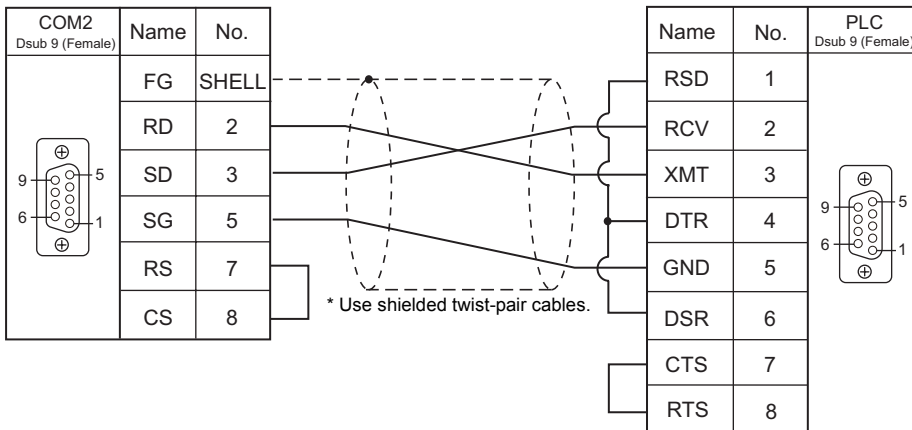

Wiring diagram 5 - COM2

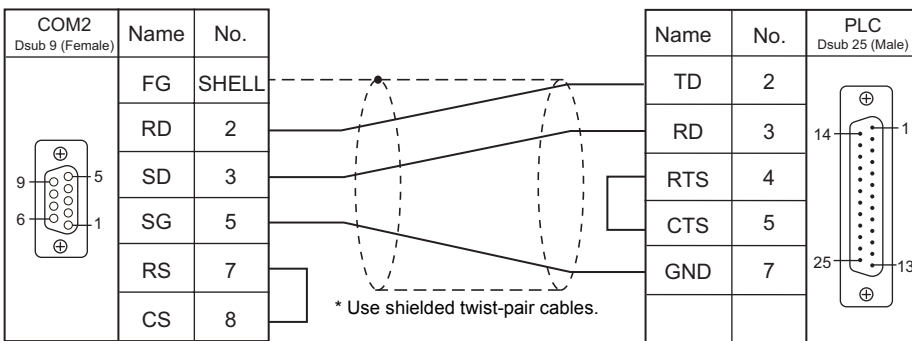

When Connected at COM3:

RS-485

Wiring diagram 1 - COM3

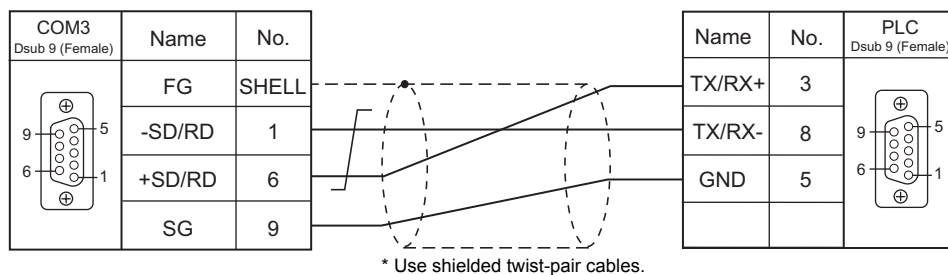

MEMO

Please use this page freely.

43. SINFONIA TECHNOLOGY

43.1 PLC Connection

43.1 PLC Connection

Serial Connection

PLC Selection on the Editor	CPU	Unit/Port	Signal Level	TS Port	Connection	Ladder Transfer ^{*1}
SELMART	SELMART-100 and later	01M2-UCI-6x 01M2-UCI-Ax	RS-232C	COM2	Wiring diagram 1 - COM2	×

*1 For the ladder transfer function, see "Appendix 5 Ladder Transfer Function".

43.1.1 SELMART

Communication Setting

Editor

Communication setting

(Underlined setting: default)

Item	Setting	Remarks
Connection Mode	<u>1:1</u> / 1 : n / Multi-link / Multi-link2	
Signal Level	<u>RS-232C</u> / RS-422/485	
Baud Rate	4800 / 9600 / <u>19200</u> bps	
Data Length	<u>7</u> bits	
Stop Bit	<u>1</u> bit	
Parity	<u>Even</u>	
Target Port No.	1 to 8	Set the same number as the one set by the DEV. NO. switch on the PLC.

PLC

An application program is necessary on the PLC to communicate with the TS series. For more information, refer to the specifications sheet of the PLC.

01M2-UCI-6x

DEV. NO. switch

SW	Setting	Remarks
DEV. NO.	1 to 8	

SELMART SUPPORT SYSTEM

Set desired values for internal addresses in the PLC. For more information, refer to the specifications sheet of the PLC.

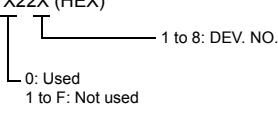
Address	Item	Setting	Remarks
C4096 to C4111	Card usage status	X22X (HEX) 	The standard entry table is used. When using an expanded entry table, refer to the specifications sheet of the PLC.
DEV. NO. 1	C4333	Baud rate	4800 / 9600 / 19200
	C4334	Communication mode	0: GD-80
DEV. NO. 2	C4341	Baud rate	4800 / 9600 / 19200
	C4342	Communication mode	0: GD-80
DEV. NO. 3	C4349	Baud rate	4800 / 9600 / 19200
	C4350	Communication mode	0: GD-80
DEV. NO. 4	C4357	Baud rate	4800 / 9600 / 19200
	C4358	Communication mode	0: GD-80
DEV. NO. 5	C4365	Baud rate	4800 / 9600 / 19200
	C4366	Communication mode	0: GD-80
DEV. NO. 6	C4373	Baud rate	4800 / 9600 / 19200
	C4374	Communication mode	0: GD-80
DEV. NO. 7	C4381	Baud rate	4800 / 9600 / 19200
	C4382	Communication mode	0: GD-80
DEV. NO. 8	C4389	Baud rate	4800 / 9600 / 19200
	C4390	Communication mode	0: GD-80

The following settings are fixed; data length: 7 bits, stop bit: 1 bit and parity: even. Changes take effect when the power is turned off and on again.

* Be sure to set "mode 0" for the CPU card operation mode.

Calendar

This model is equipped with the calendar function; however, the calendar data cannot be written from the TS series. Thus, time correction must be performed on the PLC side.

01M2-UCI-Ax

DEV. NO. switch (station number)

SW	Setting	Remarks
DEV. NO.	1 to 8	

UC1-HL switch (unit communication function setting)

SW	Setting	Remarks
H	6	UC1-6X (communication for touch panel)
L	0, 1 / 2 / F	

SELMART SUPPORT SYSTEM

Set desired values for internal addresses in the PLC. For more information, refer to the specifications sheet of the PLC.

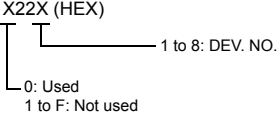
Address	Item	Setting	Remarks
C4096 to C4111	Card usage status	X22X (HEX) 	The standard entry table is used. When using an expanded entry table, refer to the specifications sheet of the PLC.
DEV. NO. 1	C4333	Baud rate	4800 / 9600 / 19200
	C4334	Communication mode	0: GD-80
DEV. NO. 2	C4341	Baud rate	4800 / 9600 / 19200
	C4342	Communication mode	0: GD-80
DEV. NO. 3	C4349	Baud rate	4800 / 9600 / 19200
	C4350	Communication mode	0: GD-80
DEV. NO. 4	C4357	Baud rate	4800 / 9600 / 19200
	C4358	Communication mode	0: GD-80
DEV. NO. 5	C4365	Baud rate	4800 / 9600 / 19200
	C4366	Communication mode	0: GD-80
DEV. NO. 6	C4373	Baud rate	4800 / 9600 / 19200
	C4374	Communication mode	0: GD-80
DEV. NO. 7	C4381	Baud rate	4800 / 9600 / 19200
	C4382	Communication mode	0: GD-80
DEV. NO. 8	C4389	Baud rate	4800 / 9600 / 19200
	C4390	Communication mode	0: GD-80

The following settings are fixed; data length: 7 bits, stop bit: 1 bit and parity: even.
Changes take effect when the power is turned off and on again.

* **Be sure to set "mode 0" for the CPU card operation mode.**

Calendar

This model is equipped with a calendar function; however, the calendar data cannot be written from the TS series. Thus, time correction must be performed on the PLC side.

Available Memory

The available memory setting range varies depending on the PLC model. Be sure to set within the range available for the PLC. Use [TYPE] when assigning the indirect memory for macro programs.

Memory	TYPE	Remarks
D (data register)	00H	D0 to D1023

* **Addresses other than D0 to D1023 can be set on the editor; however it cannot be used actually. If such an address is set, an error code "06" occurs. Do not specify any addresses other than D0 to D1023.**

43.1.2 Wiring Diagrams

When Connected at COM2:

RS-232C

Wiring diagram 1 - COM2

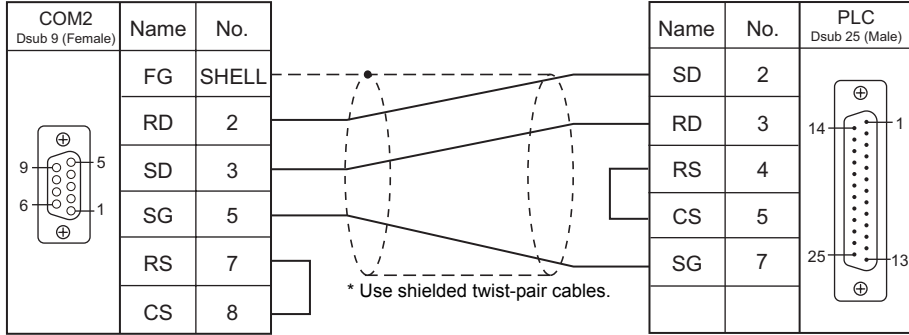

44. TECO

44.1 PLC Connection

44.1 PLC Connection

Serial Connection

PLC Selection on the Editor	CPU	Unit/Port	Signal Level	TS Port	Connection	Ladder Transfer ^{*1}
TP03 (MODBUS RTU)	TP03-xxSx-x TP03-xxMx-x	PC / PDA port	RS-232C	COM2	TECO "TP-302PC" + Wiring diagram 1 - COM2	×
			RS-422	COM1	Wiring diagram 2 - COM1	
		Expansion card	RS-485	COM1	Wiring diagram 1 - COM1	
				COM3	Wiring diagram 1 - COM3	
	TP03-xxHx-x	PC/PDA port	RS-232C	COM2	TECO "TP-302PC" + Wiring diagram 1 - COM2	
			RS-422	COM1	Wiring diagram 2 - COM1	
		RS-485 port Expansion card	RS-485	COM1	Wiring diagram 1 - COM1	
				COM3	Wiring diagram 1 - COM3	

*1 For the ladder transfer function, see "Appendix 5 Ladder Transfer Function".

44.1.1 TP03 (MODBUS RTU)

Communication Setting

Editor

Communication setting

(Underlined setting: default)

Item	Setting	Remarks
Connection Mode	<u>1</u> : 1 / 1 : n / Multi-link2	
Signal Level	<u>RS-232C</u> / RS-422/485	
Baud Rate	4800 / 9600 / <u>19200</u> / 38400 / 57600 76800 bps	
Data Length	8 bits	
Stop Bit	1 / <u>2</u> bits	
Parity	Odd / Even / <u>None</u>	
Target Port No.	<u>1</u> to 31	

PLC

Be sure to match the settings to those made on the [Communication Setting] tab window of the editor.
Set a port number in the communication software. For more information, refer to the PLC manual issued by the manufacturer.

PC/PDA Port

Use bits 0 to 7 at D8321 for the following settings.

Memory	Setting																																																					
D8321	<div style="text-align: center;"> <table border="1" style="margin: 0 auto;"> <tr> <td>7</td><td>6</td><td>5</td><td>4</td><td>3</td><td>2</td><td>1</td><td>0</td> </tr> <tr> <td style="width: 20px; height: 20px;"></td><td style="width: 20px; height: 20px;"></td><td style="width: 20px; height: 20px;"></td><td style="width: 20px; height: 20px;"></td><td style="width: 20px; height: 20px;"></td><td style="width: 20px; height: 20px;"></td><td style="width: 20px; height: 20px;"></td><td style="width: 20px; height: 20px; text-align: center;">1</td> </tr> </table> <div style="display: flex; justify-content: space-around; align-items: flex-start;"> <div style="text-align: center;"> <p>→ Baud rate</p> <table border="1" style="margin: 0 auto;"> <thead> <tr> <th>7</th><th>6</th><th>5</th><th>4</th><th>Baud Rate</th></tr> </thead> <tbody> <tr> <td>0</td><td>1</td><td>1</td><td>1</td><td>9600 bps</td></tr> <tr> <td>1</td><td>0</td><td>0</td><td>0</td><td>19200 bps</td></tr> <tr> <td>1</td><td>0</td><td>0</td><td>1</td><td>38400 bps</td></tr> <tr> <td>1</td><td>0</td><td>1</td><td>0</td><td>57600 bps</td></tr> </tbody> </table> </div> <div style="text-align: center;"> <p>→ Stop bit 0: 1 bit 1: 2 bits</p> </div> <div style="text-align: center;"> <p>→ Parity</p> <table border="1" style="margin: 0 auto;"> <thead> <tr> <th>2</th><th>1</th><th>Parity</th></tr> </thead> <tbody> <tr> <td>0</td><td>0</td><td>None</td></tr> <tr> <td>0</td><td>1</td><td>Odd</td></tr> <tr> <td>1</td><td>1</td><td>Even</td></tr> </tbody> </table> </div> <div style="text-align: center;"> <p>→ Data length 1 : 8 bits</p> </div> </div> </div>	7	6	5	4	3	2	1	0								1	7	6	5	4	Baud Rate	0	1	1	1	9600 bps	1	0	0	0	19200 bps	1	0	0	1	38400 bps	1	0	1	0	57600 bps	2	1	Parity	0	0	None	0	1	Odd	1	1	Even
7	6	5	4	3	2	1	0																																															
							1																																															
7	6	5	4	Baud Rate																																																		
0	1	1	1	9600 bps																																																		
1	0	0	0	19200 bps																																																		
1	0	0	1	38400 bps																																																		
1	0	1	0	57600 bps																																																		
2	1	Parity																																																				
0	0	None																																																				
0	1	Odd																																																				
1	1	Even																																																				

* If the value specified for any item is outside the allowable range, the item will be assumed to be: data length: 8 bits, parity: none, stop bit: 2 bits, or baud rate: 19200 bps.

Calendar

This model is not equipped with the calendar function. Use the built-in clock of the TS series.

RS-485 Port / Expansion Card

Use D8120 for RS-485 port settings and D8320 for expansion card settings.

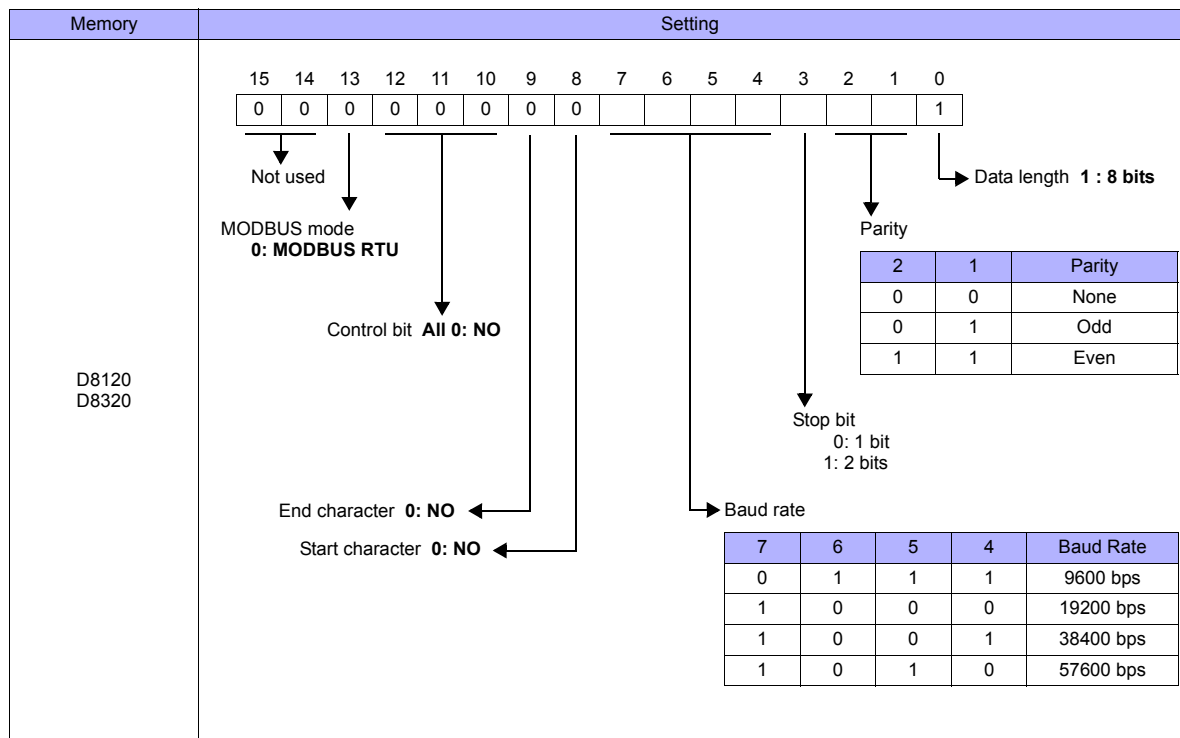

Calendar

This model is not equipped with the calendar function. Use the built-in clock of the TS series.

Available Memory

The available memory setting range varies depending on the PLC model. Be sure to set within the range available for the PLC. Use [TYPE] when assigning the indirect memory for macro programs.

Memory	TYPE	Remarks
D (Data register)	00H	
X (Digital I relay)	01H	
Y (Digital O relay)	02H	
M (Auxiliary relay)	03H	
CC (Counter [Coil])	04H	
TC (Timer [Coil])	05H	
C (Counter [Current value])	06H	
T (Timer [Current value])	07H	
CP (Counter [Preset value])	08H	
TP (Timer [Preset value])	09H	

Indirect Memory Designation

	15	8 7	0
n+0	Model	Memory type	
n+1	Address No.		
n+2	Expansion code	Bit designation	
n+3	00	Station number	

- For X/Y memory
Assign an actual address number (OCT) converted to HEX as the address number.

44.1.2 Wiring Diagrams

When Connected at COM1:

RS-422/RS-485

Wiring diagram 1 - COM1

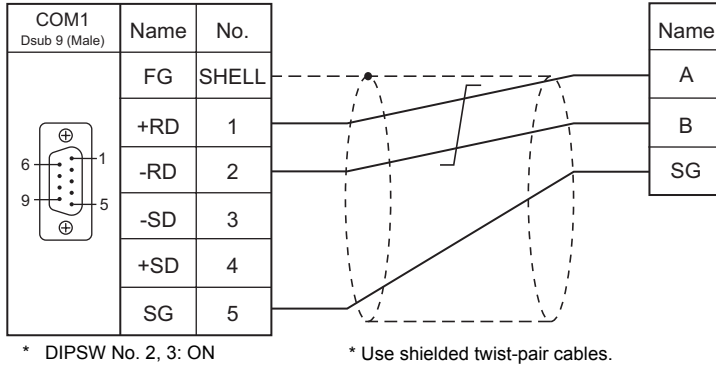

Wiring diagram 2 - COM1

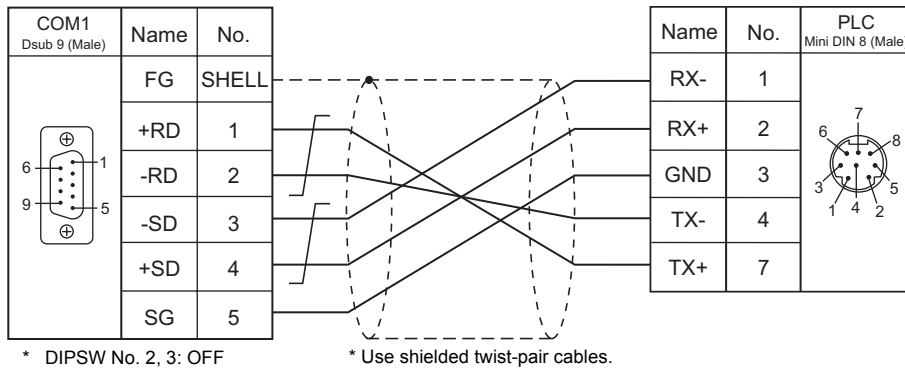

When Connected at COM2:

RS-232C

Wiring diagram 1 - COM2

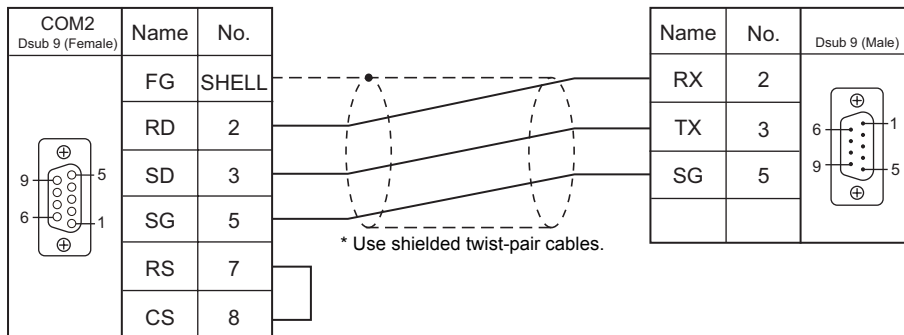

When Connected at COM3:

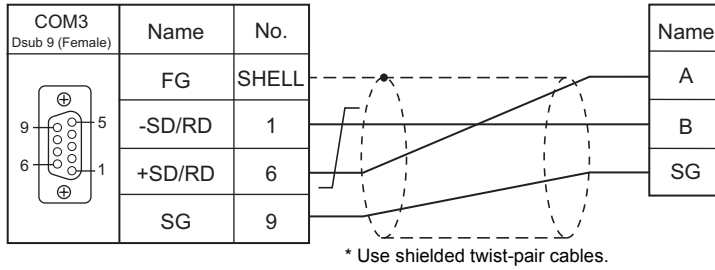
RS-485**Wiring diagram 1 - COM3**

MEMO

Please use this page freely.

45. Telemecanique

45.1 PLC Connection

45.1 PLC Connection

Serial Connection

PLC Selection on the Editor	CPU	Unit/Port	Signal Level	TS Port	Connection	Ladder Transfer *1
TSX Micro	TSX37-xx TSX57-xx	TER AUX	RS-485	COM1	Wiring diagram 1 - COM1	×
				COM3	Wiring diagram 1 - COM3	

*1 For the ladder transfer function, see "Appendix 5 Ladder Transfer Function".

45.1.1 TSX Micro

Communication Setting

Editor

Communication setting

(Underlined setting: default)

Item	Setting	Remarks
Connection Mode	Multi-link	PLC1 to PLC8 valid Local port Nos. 1 to 8 valid (4 as default)
Signal Level	RS-422/485	
Baud Rate	<u>9600 bps</u>	
Data Length	8 bits	
Stop Bit	1 bit	
Parity	None / <u>Odd</u> / Even	

PLC

TER / AUX Port

Make PLC settings using the application software "PL7 Junior". For more information, refer to the PLC manual issued by the manufacturer.

Item	Setting	Remarks
CHANNEL 0:	UNI-TELWAY LINK	
Transmission speed	9600 bits/s	
Parity	Even / Odd / None	

Available Memory

The available memory setting range varies depending on the PLC model. Be sure to set within the range available for the PLC. Use [TYPE] when assigning the indirect memory for macro programs.

Memory	TYPE	Remarks
MW (Memory Word)	00H	
KW (Constant Word)	01H	Read only
M (Bit Memory)	02H	

45.1.2 Wiring Diagrams

When Connected at COM1:

RS-485

Wiring diagram 1 - COM1

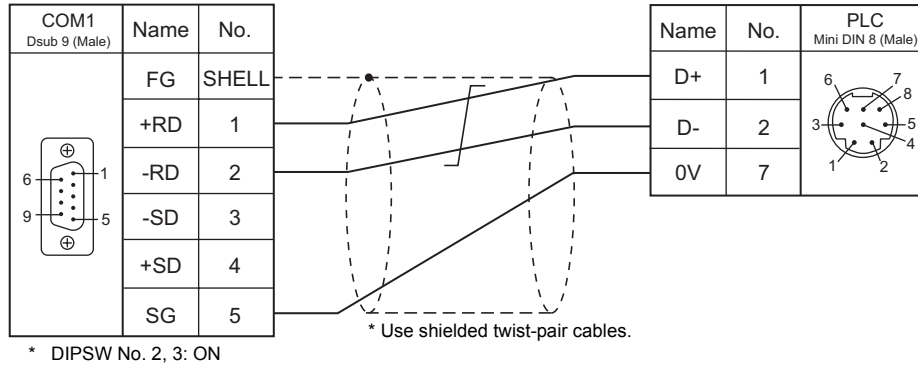

When Connected at COM3:

RS-485

Wiring diagram 1 - COM3

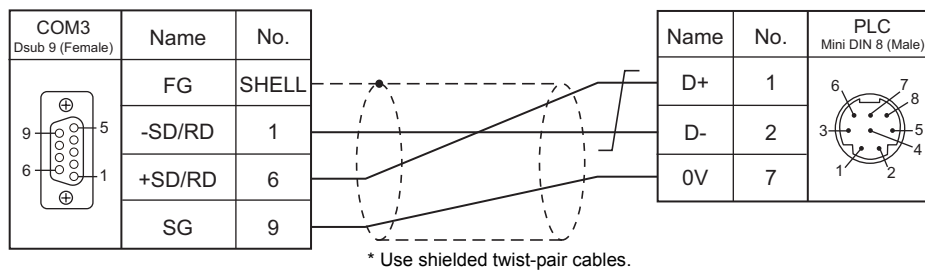

MEMO

Please use this page freely.

46. TOHO

46.1 Temperature Controller/Servo/Inverter Connection

46.1 Temperature Controller/Servo/Inverter Connection

Digital Temperature Controller

PLC Selection on the Editor	Model	Port	Signal Level	TS Port	Connection	Lst File
TTM-000	TTM-002-x-x-AM	Terminal block	RS-485	COM1	Wiring diagram 5 - COM1	TTM-000.Lst
				COM3	Wiring diagram 5 - COM3	
	TTM-004-x-x-AM TTM-004S-x-x-AX TTM-X04-x-x-AM TTM-X04S-x-x-AX	Terminal block	RS-485	COM1	Wiring diagram 6 - COM1	
				COM3	Wiring diagram 6 - COM3	
	TTM-005-x-x-AM TTM-005S-x-x-AX TTM-006-x-x-AM TTM-006S-x-x-AX TTM-009-x-x-AM TTM-009S-x-x-AX	Terminal block	RS-485	COM1	Wiring diagram 2 - COM1	
				COM3	Wiring diagram 2 - COM3	
	TTM-007-x-x-AM TTM-007S-x-x-AX	Terminal block	RS-485	COM1	Wiring diagram 7 - COM1	
				COM3	Wiring diagram 7 - COM3	
TTM-00BT	TTM-00BT-0-R-M1 TTM-00BT-1-R-M1	TB3	RS-485	COM1	Wiring diagram 1 - COM1	TTM-00BT.Lst
				COM3	Wiring diagram 1 - COM3	
	TTM-00BT-0-R-M2 TTM-00BT-1-R-M2		RS-232C	COM2	Wiring diagram 1 - COM2	
TTM-200 (MODBUS RTU)	TTM-204	Terminal block	RS-485	COM1	Wiring diagram 2 - COM1	TD_TTM200.Lst
				COM3	Wiring diagram 2 - COM3	
	TTM-205 TTM-209	Terminal block	RS-485	COM1	Wiring diagram 3 - COM1	
				COM3	Wiring diagram 3 - COM3	
	TTM-207	Terminal block	RS-485	COM1	Wiring diagram 4 - COM1	
				COM3	Wiring diagram 4 - COM3	

46.1.1 TTM-000

Communication Setting

Editor

Communication setting

(Underlined setting: default)

Item	Setting	Remarks
Connection Mode	1 : 1 / <u>1:n</u> / Multi-link2 / Multi-link2 (Ethernet) / 1 : n Multi-link2 (Ethernet)	
Signal Level	RS-422/485	
Baud Rate	4800 / <u>9600</u> / 19200 bps	
Data Length	7 / <u>8</u> bits	
Stop Bit	1 / <u>2</u> bits	
Parity	<u>None</u> / Odd / Even	
Target Port No.	1 to 32	
BCC Check	Without BCC / <u>With BCC</u>	

Digital Temperature Controller

Communication setting

Make the communication settings in the communication setting mode (SET6) that is selected by the key on the front of the digital temperature controller.

(Underlined setting: default)

Communication Setting	Item	Contents	Setting Example
<u>Prt</u>	Communication protocol	<u>0</u> : TOHO communication protocol * Not necessary for TTM-xxx-x-x-AxxM	0
<u>Con</u>	Communication parameter		b8n2
<u>bPS</u>	Communication setting	4.8: 4800 bps <u>9.6</u> : 9600 bps 19.2: 19200 bps	9.6
<u>Adr</u>	Communication address	1 to 32	1
<u>Res</u>	Response delay time	<u>0</u> to 255 (ms)	0
<u>Mod</u>	Communication mode selection	<u>ro</u> : Read only rw: Read/write	rw

Available Memory

The available memory setting range varies depending on the device. Be sure to set within the range available with the device to be used. Use [TYPE] when assigning the indirect memory for macro programs.

Memory	TYPE	Remarks
MW (monitor data)	00H	
SW (setting data)	01H	Always set "0" for SW00137 (communication protocol setting).
ST (character string data)	02H	6-byte character string data

Read-only memory

The following types of memory are read-only.

Memory	Name	Remarks
MW00000	Measurement value (PV)	When the measurement value exceeds the upper limit, "32767" is displayed. When it falls below the lower limit, "-32768" is displayed.
MW00003	Output status monitoring	
MW00005	DI status monitoring	
SW00041	Input monitoring for event output 1CT	
SW00050	Input monitoring for event output 2CT	
SW00064	Monitoring for remaining time on timer	
ST00000	Measurement value (PV1)	

Write-only memory

The following type of memory is write-only.

Memory	Name	Remarks
MW00002	Timer start / stop	

Indirect Memory Designation

Specify the value obtained by subtracting "1" from the actual station number.

PLC_CTL

Macro command "PLC_CTL F0 F1 F2"

Contents	F0	F1 (= \$u n)		F2
Data save	1 - 8 (PLC1 - 8)	n	Station numbers 0 to 31*	2
		n + 1	Command: 0	

* Specify the value obtained by subtracting "1" from the actual station number.

46.1.2 TTM-00BT

Communication Setting

Editor

Communication setting

(Underlined setting: default)

Item	Setting	Remarks
Connection Mode	1 : 1 / <u>1-n</u> / Multi-link2	
Signal Level	<u>RS-232C</u> / RS-422/485	
Baud Rate	4800 / <u>9600</u> / 19200 / 38400 bps	
Data Length	8 bits	
Stop Bit	2 bits	
Parity	None	
Target Port No.	0 to 15	

Digital Temperature Controller

Settings related to communications can be made using switches on the controller. Before changing a setting, be sure to turn off the power to the digital temperature controller.

Unit number (station number)

(Underlined setting: default)

SW1	Contents	Setting Example
	0 to F (H) (0 to 15)	0

Baud rate

(Underlined setting: default)

SW2	Contents				Setting Example	
	DIP Switch	4800 bps	9600 bps	19200 bps	38400 bps	1: ON 2: OFF 3: OFF 4: OFF Baud rate: 9600 bps
	1	OFF	<u>ON</u>	OFF	ON	
	2	OFF	<u>OFF</u>	ON	ON	
	3	<u>OFF</u> (Not used)				
	4	<u>OFF</u> (Not used)				

The following settings are fixed; data length: 8 bits, stop bit: 2 bits, and parity: none.

Available Memory

The available memory setting range varies depending on the device. Be sure to set within the range available with the device to be used. Use [TYPE] when assigning the indirect memory for macro programs.

Memory	TYPE	Remarks
MW (monitor data)	00H	
SW (setting data)	01H	

* The memory bank number (0 to 8) and channel number (1 to 8) are required in addition to the memory type and address. The assigned memory is indicated when editing the screen as shown on the right.

Example: #2 : SW5134

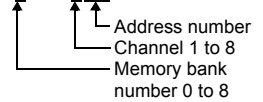

Address denotations

- To specify the memory bank currently in use, set "0" for the memory bank number. When specifying other memory banks, set the corresponding numbers.
- On the signal name reference list, every channel is designated as "0". Manually input the number (1 to 8) of the channel to use.

Read-only memory

The following types of memory are read-only.

Memory	Name	Remarks
MW000	Measurement value (PV1)	*1
MW003	Control output monitor (OM1)	
SW041	CT measurement value 1 (CM1)	*2
SW050	CT measurement value 2 (CM2)	*2
SW083	CT measurement value 3 (CM3)	*2
SW092	CT measurement value 4 (CM4)	*2
SW101	CT measurement value 5 (CM5)	*2
SW110	CT measurement value 6 (CM6)	*2
SW119	CT measurement value 7 (CM7)	*2
SW130	DI monitor (DIM)	
SW131	Event output monitor 1 to 5 (EMI)	
SW132	Event output monitor 6 to 8 (EM2)	
SW133	Alarm monitor (ALM)	

*1 When the measurement value exceeds the upper limit, "32767" is displayed. When it falls below the lower limit, "-32768" is displayed.

*2 When the measurement value exceeds the upper limit, "32767" is displayed. When it falls below the lower limit or measurement is impossible, "-32768" is displayed.

Indirect Memory Designation

	15	8 7	0
n + 0	Model		Memory type
n + 1	Memory No. (address)		
n + 2	Memory bank No.	Bit designation	
n + 3	00		Station number

- Specify the channel number (1 to 8) and memory address for the memory number (address).
Example: Channel 5, address 134:
Specify "5134" (DEC) for the memory number (address).

PLC_CTL

Macro command "PLC_CTL F0 F1 F2"

Contents	F0	F1 (= \$u n)		F2
Data save	1 - 8 (PLC1 - 8)	n	Station number	3
		n + 1	Command: 0	
		n + 2	Channel (1 - 8)	

46.1.3 TTM-200 (MODBUS RTU)

Communication Setting

Editor

Communication setting

(Underlined setting: default)

Item	Setting	Remarks
Connection Mode	1 : 1 / <u>1:n</u> / Multi-link2	
Signal Level	<u>RS-422/485</u>	
Baud Rate	4800 / <u>9600</u> / 19200 / 38400 bps	
Data Length	8 bits	
Stop Bit	1 / <u>2</u> bits	
Parity	<u>None</u> / Odd / Even	
Target Port No.	1 to 31	

Digital Temperature Controller

Communication setting

Make the communication settings in the communication setting mode (SET17) that is selected by the key on the front of the digital temperature controller.

(Underlined setting: default)

Communication Setting	Item	Contents	Setting Example
<i>PRt</i>	Communication protocol *1	1: MODBUS RTU	1
<i>CoM</i>	Communication parameter	8N1: data length 8, without parity, stop bit 1 8N2: <u>data length 8, without parity, stop bit 2</u> 8o1: data length 8, odd parity, stop bit 1 8o2: data length 8, odd parity, stop bit 2 8E1: data length 8, even parity, stop bit 1 8E2: data length 8, even parity, stop bit 2	8N2
<i>bPS</i>	Communication setting	4.8: 4800 bps <u>9.6: 9600 bps</u> 19.2: 19200 bps 38.4: 38400 bps	9.6
<i>AdR</i>	Communication address	1 to 31	1
<i>AWt</i>	Communication response delay time	<u>0</u> to 255 (ms)	0
<i>Mod</i>	Communication switching	0: Writing prohibited <u>1: Writing enabled</u> 2: Master of simultaneous rise in temperature 3: Slave of simultaneous rise in temperature	1

*1 Select "Modbus RTU" for the communication protocol on the digital temperature controller when connecting with the TS.

Available Memory

The available memory setting range varies depending on the device. Be sure to set within the range available with the device to be used. Use [TYPE] when assigning the indirect memory for macro programs.

Memory	TYPE	Remarks
4 (holding register)	00H	No address of even-numbered digits can be specified.

46.1.4 Wiring Diagrams

When Connected at COM1:

RS-485

Wiring diagram 1 - COM1

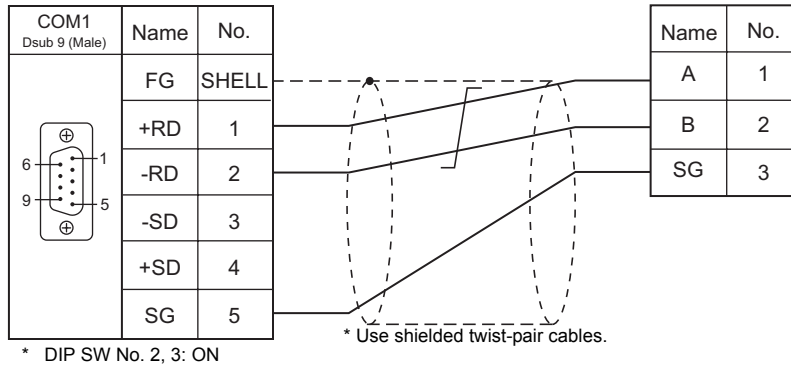

Wiring diagram 2 - COM1

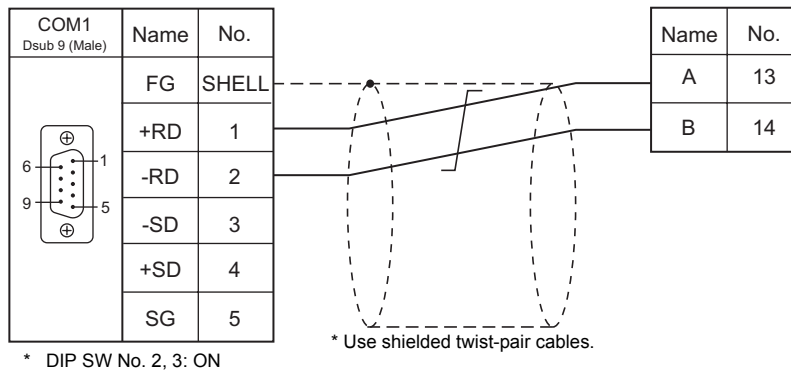

Wiring diagram 3 - COM1

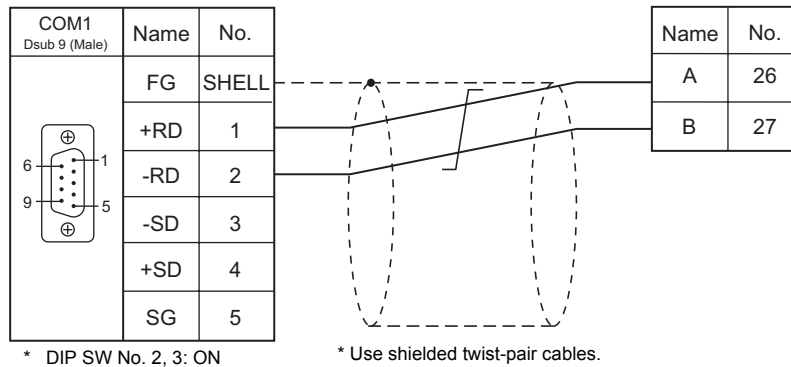

Wiring diagram 4 - COM1

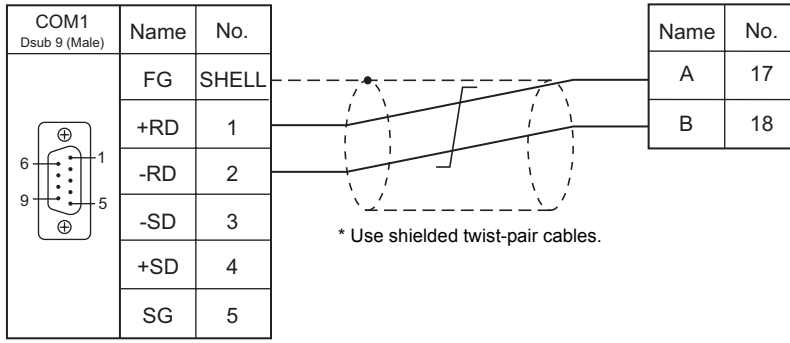

* DIP SW No. 2, 3: ON

Wiring diagram 5 - COM1

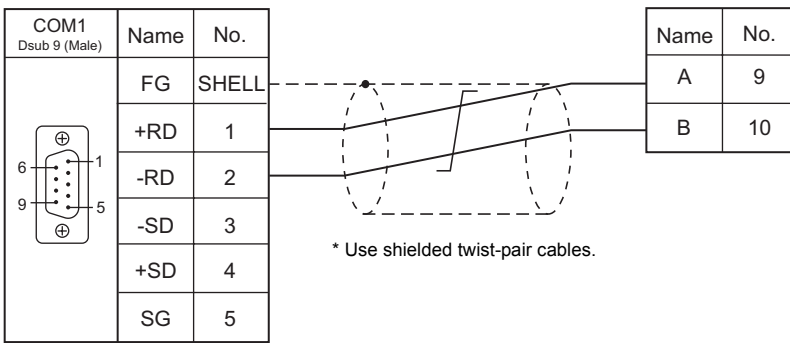

* DIP SW No. 2, 3: ON

Wiring diagram 6 - COM1

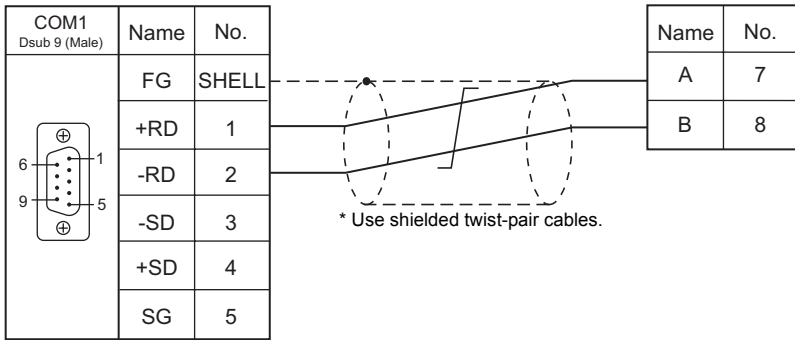

* DIP SW No. 2, 3: ON

Wiring diagram 7 - COM1

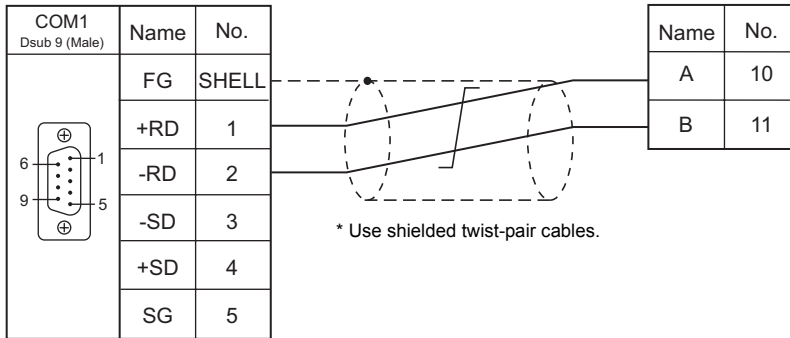

* DIP SW No. 2, 3: ON

When Connected at COM2:

RS-232C

Wiring diagram 1 - COM2

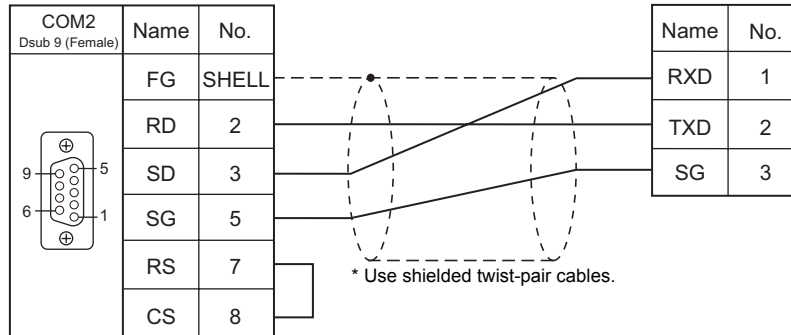

When Connected at COM3:

RS-485

Wiring diagram 1 - COM3

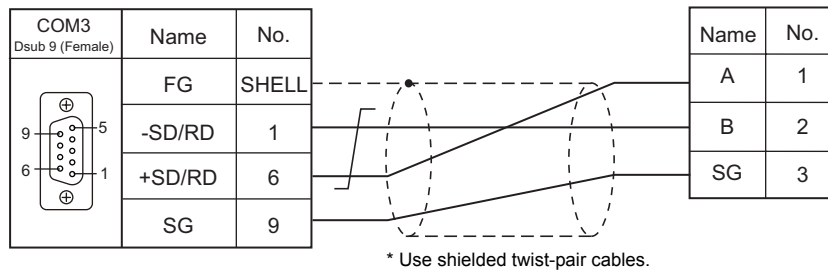

Wiring diagram 2 - COM3

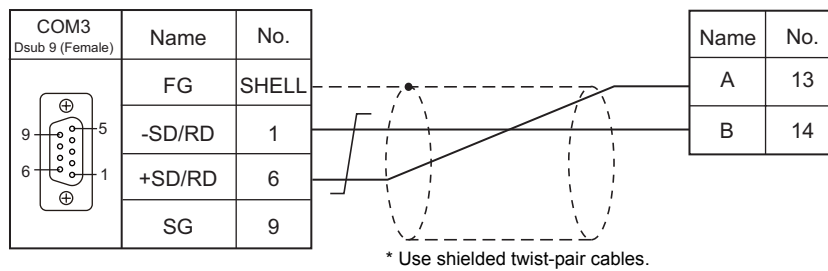

Wiring diagram 3 - COM3

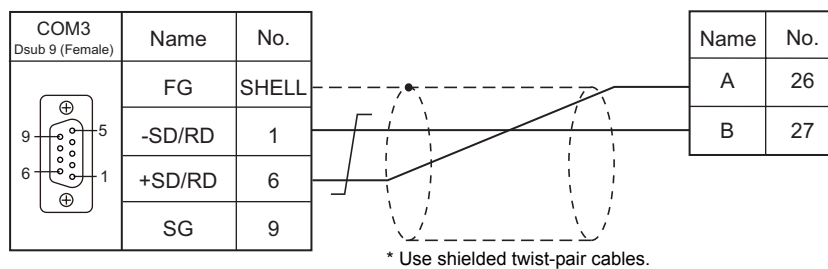

Wiring diagram 4 - COM3

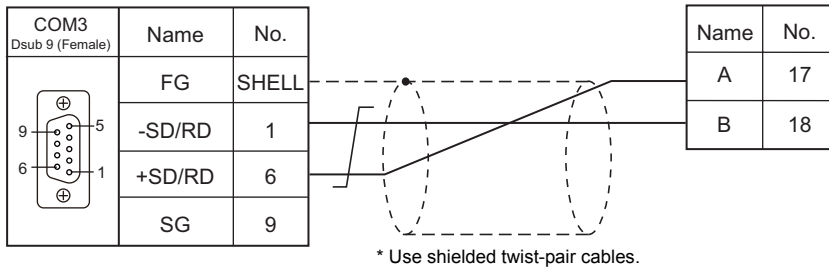

Wiring diagram 5 - COM3

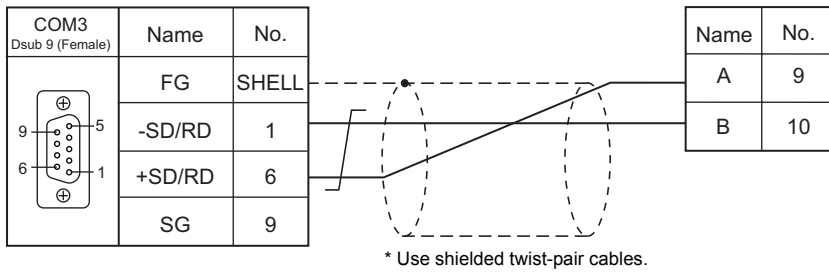

Wiring diagram 6 - COM3

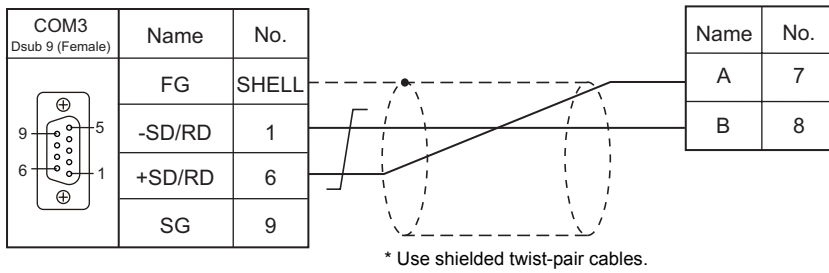

Wiring diagram 7 - COM3

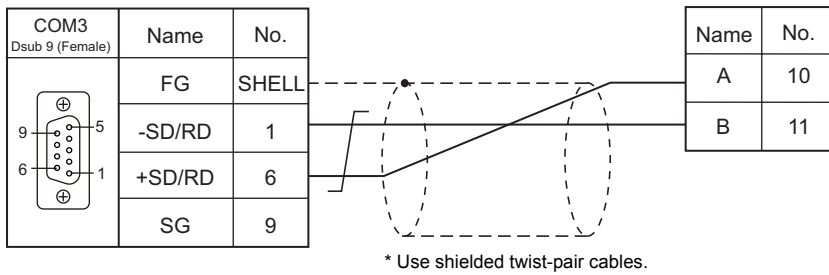

47. TOSHIBA

47.1 PLC Connection

47.2 Temperature Controller/Servo/Inverter Connection

47.1 PLC Connection

Serial Connection

PLC Selection on the Editor	PLC/CPU			Unit/Port	Signal Level	TS Port	Connection	Ladder Transfer ^{*1}
T series / TS series (T compatible)	T series	T1	T1-16 T1-28 T1-40 T1-40S	Programmer port	RS-232C	COM2	Wiring diagram 1 - COM2	×
			CU111	RS-485	COM1	Wiring diagram 1 - COM1		
		T1S	T1-40S	LINK port				
		T2	PU224	LINK port	RS-485	COM1	Wiring diagram 2 - COM1	
		T2E	PU234E	Programmer port	RS-232C	COM2	Wiring diagram 2 - COM2	
				CM232E	RS-485	COM1	Wiring diagram 1 - COM1	
				CM231E	RS-485	COM1	Wiring diagram 1 - COM1	
	T2N	PU215N PU235N PU245N	Programmer port	RS-232C	COM2	Wiring diagram 2 - COM2		
			LINK port	RS-232C	COM1	Wiring diagram 3 - COM1		
	T3	PU315 PU325	LINK port	RS-485	COM1	Wiring diagram 2 - COM1		
	T3H	PU325H PU326H						
	TS series	S2T	PU672T PU662T	Programmer port	RS-232C	COM2	Wiring diagram 2 - COM2	
				LINK port	RS-485	COM1	Wiring diagram 1 - COM1	
		S2E	PU612E	Programmer port	RS-232C	COM2	Wiring diagram 2 - COM2	
LINK port				RS-485	COM1	Wiring diagram 1 - COM1		
model 2000		S2PU22A S2PU32A S2PU72A S2PU72D S2PU82	LINK port	RS-485	COM1	Wiring diagram 1 - COM1		
model 3000	S3PU21 S3PU45A S3PU55A S3PU65A	LINK port	RS-485	COM1	Wiring diagram 2 - COM1			
EX series	EX100	MPU12A	COMP. LINK	RS-485	COM1	Wiring diagram 1 - COM1	×	
	EX250 EX500		CMP6236A					
	EX2000	MPU-6620	COMP. LINK					

*1 For the ladder transfer function, see "Appendix 5 Ladder Transfer Function".

47.1.1 T Series / TS series (T Compatible)

Communication Setting

Editor

Communication setting

(Underlined setting: default)

Item	Setting	Remarks
Connection Mode	<u>1</u> :1 / 1:n / Multi-link / Multi-link2 / Multi-link2 (Ethernet)	
Signal Level	RS-232C / <u>RS-422/485</u>	
Baud Rate	4800 / <u>9600</u> / 19200 / 38400 bps	
Parity	None / <u>Odd</u> / Even	
Data Length	7 / <u>8</u> bits	
Stop Bit	<u>1</u> / 2 bits	
Target Port No.	<u>1</u> to 31	

PLC

T1/T1S (Programmer Port)/CU111

System information

(Underlined setting: default)

Item	Setting	Remarks
Operation Mode	Computer link (ASCII)	
Signal Level	Programmer port: RS-232C CU111: RS-485	
Baud Rate	9600 bps (fixed)	
Parity	None / <u>Odd</u>	
Data Length	8 bits (fixed)	
Stop Bit	1 bit (fixed)	
Station No.	<u>1</u> to 31	

T1S (Link Port)

Special register (SW056), system information

(Underlined setting: default)

Item	Link Port	Remarks
Operation Mode	Computer link (ASCII)	Special register SW056 = 0 The setting takes effect when the EEPROM write command is executed and the power is turned off and back on again.
Signal Level	RS-485	
Baud Rate	4800 / 9600 / 19200 bps	
Parity	None / <u>Odd</u> / Even	
Data Length	7 / <u>8</u> bits	
Stop Bit	<u>1</u> / 2 bits	
Station No.	<u>1</u> to 31	

T2E/T2N (Programmer Port)

Operation mode setting switch

Switch	Contents	Setting	Remarks
 SW6: COM	Programmer port parity setting	OFF: Odd parity ON: Without parity	The setting takes effect when the power is turned off and back on again.

The following settings are fixed; baud rate: 9600 bps, data length: 8 bits, and stop bit: 1 bit.

T2E (Option Card CM231E/CM232E)

Operation mode setting switch

The settings are made by the DIP switch on the front of the CPU module (PU234E).

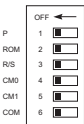
Switch	Contents	Setting	Remarks
 SW4: CM0	Option communication mode setting Function: computer link	OFF	The settings take effect when the power is turned off and back on again.
		SW5: CM1	

Transmission parameter setting

Transmission parameters are set on the system information area of T2E.

(Underlined setting: default)

Item	Setting	Remarks
Signal Level	CM231E: RS-485 CM232E: RS-232C	The settings take effect when the EEPROM write command is executed and the power is turned off and back on again.
Baud Rate	4800 / 9600 / 19200 bps	
Parity	None / <u>Odd</u> / Even	
Data Length	7 / <u>8</u> bits	
Stop Bit	<u>1</u> / 2 bits	
Station No.	<u>1</u> to 31	

T2N (LINK Port)

Operation mode setting switch

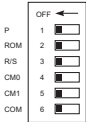
Switch	Contents	Setting	Remarks
	SW4: CM0	OFF	The settings take effect when the power is turned off and back on again.
	SW5: CM1	OFF	

Communication port select switch

Switch	Contents	Setting	Remarks
	SW1	Signal Level	OFF: RS-485 ON: RS-232C

The following settings are fixed; baud rate: 9600 bps, data length: 8 bits, and stop bit: 1 bit.

Transmission parameter setting

Transmission parameters are set on the system information area of T2N.

(Underlined setting: default)

Item	Setting	Remarks
Signal Level	CM231E: RS-485 CM232E: RS-232C	The settings take effect when the EEPROM write command is executed and the power is turned off and back on again.
Baud Rate	4800 / 9600 / 19200 bps	
Parity	None / <u>Odd</u> / Even	
Data Length	7 / <u>8</u> bits	
Stop Bit	<u>1</u> / 2 bits	
Station No.	<u>1</u> to 31	

T3/T3H (LINK Port)

Transmission parameter setting

Transmission parameters are set on the system information area.

(Underlined setting: default)

Item	Setting	Remarks
Signal Level	RS-485	The settings take effect when the EEPROM write command is executed and the power is turned off and back on again.
Baud Rate	4800 / 9600 / 19200 bps	
Parity	None / <u>Odd</u> / Even	
Data Length	7 / <u>8</u> bits	
Stop Bit	<u>1</u> / 2 bits	
Station No.	<u>1</u> to 31	

S2E/S2T (Programmer Port)

Operation mode setting switch

Switch	Contents	OFF	ON	Remarks
3 : P	Programmer port parity setting	Odd parity	Without parity	

The following settings are fixed; baud rate: 9600 bps, data length: 8 bits, and stop bit: 1 bit.

S2E/S2T (LINK Port)

Set special registers and system information using the engineering tool.
After making settings, execute the ROM write command and turn the power off and back it on again to determine the settings.

Operation mode

Special Register	Setting	Remarks
SW069	0: Computer link (ASCII)	

System information

(Underlined setting: default)

Item	Setting	Remarks
Computer Link Setting	Station No. <u>1</u> to 31	
Connection Mode	Baud Rate	4800 / <u>9600</u> / 19200 bps
	Parity	None / <u>Odd</u> / Even
	Data Length	7 / <u>8</u> bits
	Stop Bit	<u>1</u> / 2 bits

model2000/3000

Set module parameters using the engineering tool.

Module parameter

(Underlined setting: default)

Item	Setting	Remarks
RS-485 Station No.	<u>1</u> to 31	
RS-485 Baud Rate (bit/s)	4800 / <u>9600</u> / 19200 / 38400 bps	
RS-485 Parity Setting	None / <u>Odd</u> / Even	
RS-485 Data Length	7 / <u>8</u> bits	
RS-485 Stop Bit	<u>1</u> / 2 bits	

Available Memory

The available memory setting range varies depending on the PLC model. Be sure to set within the range available for the PLC. Use [TYPE] when assigning the indirect memory for macro programs.

(Underlined setting: default)

Memory	TYPE	Remarks
D (data register)	00H	
X (input)	01H	XW as word device
Y (output)	02H	YW as word device
R (auxiliary relay)	05H	RW as word device
L (link relay)	06H	LW as word device, not available with model2000 and model3000.
W (link register)	07H	Not available with model2000 and model3000
F (file register)	08H	
TN (timer/current value)	09H	Read only, not available with model2000 and model3000
CN (counter/current value)	0AH	Read only, not available with model2000 and model3000
TS (timer/contact)	0BH	Read only, not available with model2000 and model3000
CS (counter/contact)	0CH	Read only, not available with model2000 and model3000

47.1.2 EX Series

Communication Setting

Editor

Communication setting

(Underlined setting: default)





Item	Setting	Remarks
Connection Mode	<u>1</u> :1 / 1 : n / Multi-link2 / Multi-link2 (Ethernet)	
Signal Level	RS-232C / <u>RS-422/485</u>	
Baud Rate	4800 / <u>9600</u> bps	
Parity	None / <u>Odd</u> / Even	
Data Length	7 / <u>8</u> bits	
Stop Bit	<u>1</u> / 2 bits	
Target Port No.	0 to 15	For EX200/500: 0 to 7

PLC

EX100

Make settings by using the switches on the CPU module. The following settings are fixed; data length: 8 bits, and stop bit: 1 bit.

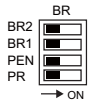

Switch

Switch	Setting	Remarks
Communication switch 	LINK: computer link	
Station No. 	0 to F (= 0 to 15)	The settings take effect when the power is turned off and back on again.
Baud Rate 	9600 bps (BR2: OFF, BR1: OFF) 4800 bps (BR2: OFF, BR1: ON)	
Parity 	Odd (PEN: ON, PR: OFF) Even (PEN: ON, PR: ON) None (PEN: OFF, PR: OFF/ON)	

EX250/EX500

Make settings by using the switches on the CPU module. The following settings are fixed; data length: 8 bits, and stop bit: 1 bit.

Switch

Switch	Setting	Remarks
Write enable switch		ON: Write enabled
Station No.		0 to 7
DNT8	SP0	0: EX control command enabled
	SP1	0: Block write command enabled
	SP2	1: ASCII mode
	BR	9600 bps (BR0: 1, BR1: 0, BR2: 0) 4800 bps (BR0: 0, BR1: 1, BR2: 0)
	PEN EVN	Odd (PEN: 0, EVN: 1) Even (PEN: 0, EVN: 0) None (PEN: 1, EVN: 0/1)

EX2000

Make settings for system information (16. COMPUTER LINK) by using the graphic programmer.

System information

(Underlined setting: default)

Item	Setting	Remarks
STATION No.	<u>1</u> to 31	
BAUD RATE	4800 / 9600 bps	
PARITY	0: None 1: <u>Odd</u> 2: Even	
DATA LENGTH	8 bits (fixed)	
STOP BIT	1.0: 1 bits 2.0: 2 bits	

Available Memory

The available memory setting range varies depending on the PLC model. Be sure to set within the range available for the PLC. Use [TYPE] when assigning the indirect memory for macro programs.

Memory	TYPE	Remarks
D (data register)	00H	
X (input)	01H	XW as word device
Y (output)	02H	YW as word device
R (auxiliary relay)	03H	RW as word device
Z (link relay)	04H	ZW as word device
TN (timer/current value)	05H	Read only
CN (counter/current value)	06H	Read only

47.1.3 Wiring Diagrams

When Connected at COM1:

RS-422

Wiring diagram 1 - COM1

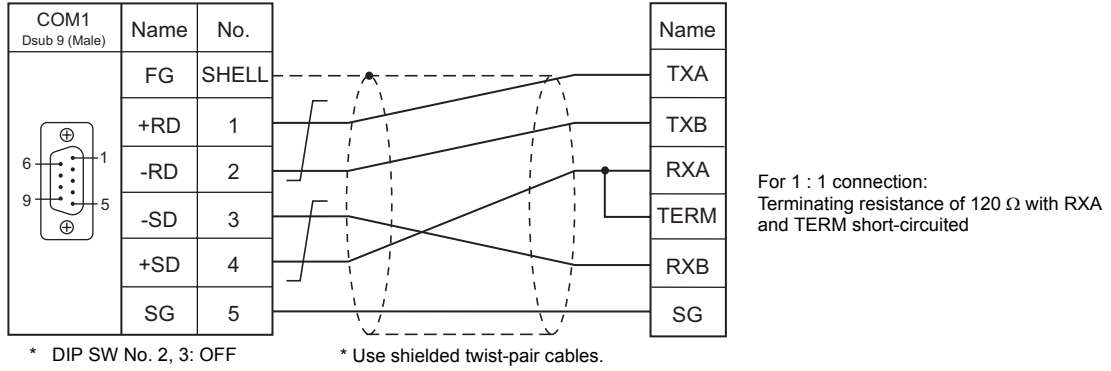

Wiring diagram 2 - COM1

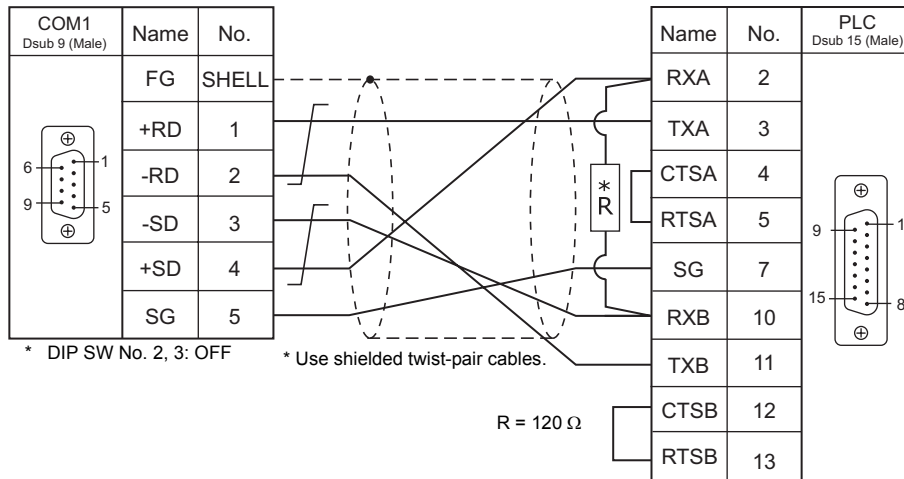

Wiring diagram 3 - COM1

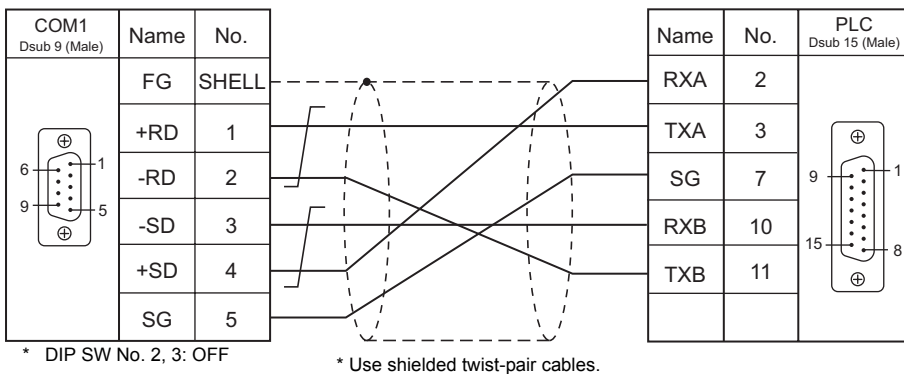

When Connected at COM2:

RS-232C

Wiring diagram 1 - COM2

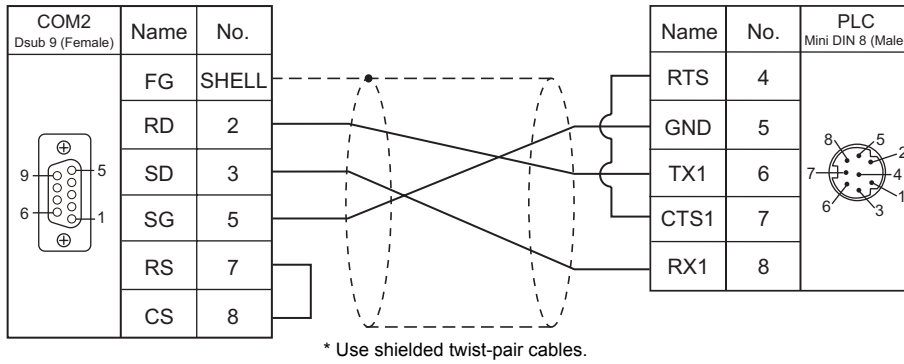

Wiring diagram 2 - COM2

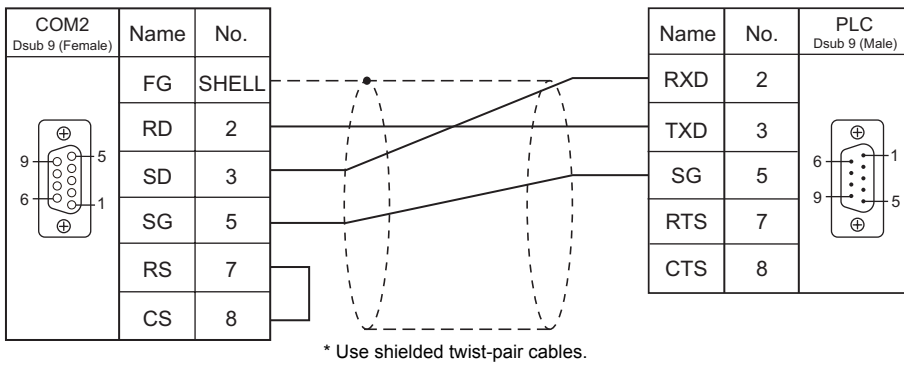

47.2 Temperature Controller/Servo/Inverter Connection

The controller models shown below can be connected.

Inverter

PLC Selection on the Editor	Model	Port	Signal Level	TS Port	Connection	Lst File
VF-S7	VF-S7	RS2001Z	RS-232C	COM2	Wiring diagram 1 - COM2	VFS7.Lst
		RS4001Z	RS-485	COM1	Wiring diagram 1 - COM1	
				COM3	Wiring diagram 1 - COM3	
VF-S9	VF-S9	RS2001Z	RS-232C	COM2	Wiring diagram 1 - COM2	VFS9.Lst
		RS4001Z	RS-485	COM1	Wiring diagram 1 - COM1	
				COM3	Wiring diagram 1 - COM3	
VF-S11	VF-S11	RS2001Z	RS-232C	COM2	Wiring diagram 1 - COM2	VFS11.Lst
		RS20035	RS-232C	COM2	Wiring diagram 2 - COM2	
		RS4001Z RS4002Z RS4003Z	RS-485	COM1	Wiring diagram 1 - COM1	
VF-A7	VF-A7	RS2001Z	RS-232C	COM2	Wiring diagram 1 - COM2	VFA7.Lst
		RS4001Z	RS-485	COM1	Wiring diagram 1 - COM1	
				COM3	Wiring diagram 1 - COM3	
		RS-485 connector	RS-485	COM1	Wiring diagram 2 - COM1	
COM3	Wiring diagram 2 - COM3					
VF-AS1	VF-AS1	2-wire RS-485 connector	RS-485	COM1	Wiring diagram 3 - COM1	VFAS1.Lst
		4-wire RS-485 connector	RS-485	COM3	Wiring diagram 3 - COM3	
				COM1	Wiring diagram 2 - COM1	
VF-P7	VF-P7	RS2001Z	RS-232C	COM2	Wiring diagram 1 - COM2	VFP7.Lst
				COM1	Wiring diagram 1 - COM1	
		RS4001Z	RS-485	COM3	Wiring diagram 1 - COM3	
				COM1	Wiring diagram 2 - COM1	
VF-PS1	VF-PS1	2-wire RS-485 connector	RS-485	COM3	Wiring diagram 2 - COM3	VFPS1.Lst
				COM1	Wiring diagram 3 - COM1	
		4-wire RS-485 connector	RS-485	COM1	Wiring diagram 2 - COM1	
				COM3	Wiring diagram 2 - COM3	
VF-FS1	VF-FS1	Communication connector	RS-485	COM1	Wiring diagram 3 - COM1	VFFS1.Lst
				COM3	Wiring diagram 3 - COM3	
VF-nC1	VF-nC1	RS2001Z	RS-232C	COM2	Wiring diagram 1 - COM2	VFnC1.Lst
		RS4001Z RS4002Z	RS-485	COM1	Wiring diagram 1 - COM1	
				COM3	Wiring diagram 1 - COM3	

47.2.1 VF-S7

Communication Setting

Editor

Communication setting

(Underlined setting: default)

Item	Setting	Remarks
Connection Mode	1 : 1 / <u>1:n</u> / Multi-link2 / Multi-link2 (Ethernet)	
Signal Level	RS-232C / <u>RS-422/485</u>	
Baud Rate	4800 / <u>9600</u> bps	
Data Length	<u>8</u> bits	
Stop Bit	<u>1</u> / 2 bits	
Parity	None / Odd / <u>Even</u>	
Target Port No.	<u>0</u> to 31	

Inverter

Communication parameter (group No. 08)

The communication parameters can be set using keys attached to the inverter.

Be sure to match the settings to those made on the [Communication Setting] tab window of the editor.

(Underlined setting: default)

Parameter	Indication	Item	Setting	Default
Communication	F800	Baud rate	2: 4800 bps 3: <u>9600 bps</u>	3
	F801	Parity	0: None 1: <u>Even</u> 2: Odd	1
	F802	Inverter number (station number)	<u>0</u> to 31	0
	F803	Communication error trip time	<u>0</u> : Inactive 1 to 100 seconds	0

The data length is fixed to "8 bits".

Changes to parameters take effect when the power is turned off and on again.

RS4001Z: baud rate and terminating resistance setting switch

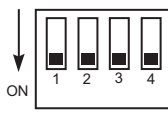
Switch	Contents	Setting	Setting Example									
1, 2	Baud rate *	<table border="1"> <thead> <tr> <th></th> <th>4800</th> <th>9600</th> </tr> </thead> <tbody> <tr> <td>SW1</td> <td>OFF</td> <td>ON</td> </tr> <tr> <td>SW2</td> <td>ON</td> <td>ON</td> </tr> </tbody> </table>		4800	9600	SW1	OFF	ON	SW2	ON	ON	 <p>Baud rate: 9600 bps Terminating resistance: Provided</p>
	4800	9600										
SW1	OFF	ON										
SW2	ON	ON										
3	Terminating resistance on the receiving side	ON: Provided OFF: Not provided										
4	Terminating resistance on the sending side	ON: Provided OFF: Not provided										

* Set the same baud rate as the one set for the communication parameter "F800" of the inverter.

Available Memory

The available memory setting range varies depending on the device. Be sure to set within the range available with the device to be used. Use [TYPE] when assigning the indirect memory for macro programs.

Memory	TYPE	Remarks
--	00H	

Specify the storage target memory address on the [Memory Input] dialog.

RAM: Store in RAM

EEPROM: Store in RAM + EEPROM

Indirect Memory Designation

	15	8	7	0
n + 0	Model (11 to 18)		Memory type	
n + 1	Memory number (address)			
n + 2	Expansion code *		Bit designation	
n + 3	00		Station number	

* Specify the storage target memory address in the expansion code.

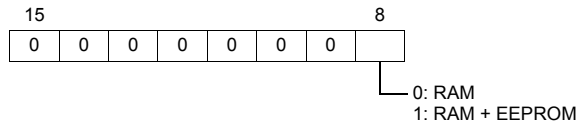

47.2.2 VF-S9

Communication Setting

Editor

Communication setting

(Underlined setting: default)

Item	Setting	Remarks
Connection Mode	1 : 1 / <u>1:n</u> / Multi-link2 / Multi-link2 (Ethernet)	
Signal Level	RS-232C / <u>RS-422/485</u>	
Baud Rate	4800 / <u>9600</u> / 19200 bps	
Data Length	<u>8</u> bits	
Stop Bit	<u>1</u> / 2 bits	
Parity	None / Odd / <u>Even</u>	
Target Port No.	<u>0</u> to 31	

Inverter

Communication parameter (group No. 08)

The communication parameters can be set using keys attached to the inverter.

Be sure to match the settings to those made on the [Communication Setting] tab window of the editor.

(Underlined setting: default)

Parameter	Indication	Item	Setting	Default
Communication	F800	Baud rate	2: 4800 bps 3: <u>9600 bps</u> 4: 19200 bps	3
	F801	Parity	0: None 1: <u>Even</u> 2: Odd	1
	F802	Inverter number (station number)	<u>0</u> to 31	0
	F803	Communication error trip time	<u>0</u> : Inactive 1 to 100 seconds	0
	F805	Transmission latency setting *	<u>0.00</u> : Normal communication 0.01 to 2.00 seconds	0.00

* Necessary for the CPU version V110 and later

The data length is fixed to "8 bits".

Changes to parameters take effect when the power is turned off and on again.

RS4001Z: baud rate and terminating resistance setting switch

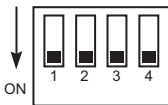
Switch	Contents	Setting	Setting Example									
1, 2	Baud rate *	<table border="1"> <thead> <tr> <th></th> <th>4800</th> <th>9600</th> </tr> </thead> <tbody> <tr> <td>SW1</td> <td>OFF</td> <td>ON</td> </tr> <tr> <td>SW2</td> <td>ON</td> <td>ON</td> </tr> </tbody> </table>		4800	9600	SW1	OFF	ON	SW2	ON	ON	 <p>Baud rate: 9600 bps Terminating resistance: Provided</p>
	4800	9600										
SW1	OFF	ON										
SW2	ON	ON										
3	Terminating resistance on the receiving side	ON: Provided OFF: Not provided										
4	Terminating resistance on the sending side	ON: Provided OFF: Not provided										

* Set the same baud rate as the one set for the communication parameter "F800" of the inverter.

Available Memory

The available memory setting range varies depending on the device. Be sure to set within the range available with the device to be used. Use [TYPE] when assigning the indirect memory for macro programs.

Memory	TYPE	Remarks
--	00H	

Specify the storage target memory address on the [Memory Input] dialog.

RAM: Store in RAM

EEPROM: Store in RAM + EEPROM

Indirect Memory Designation

	15	8	7	0
n + 0	Model (11 to 18)		Memory type	
n + 1	Memory number (address)			
n + 2	Expansion code *		Bit designation	
n + 3	00		Station number	

* Specify the storage target memory address in the expansion code.

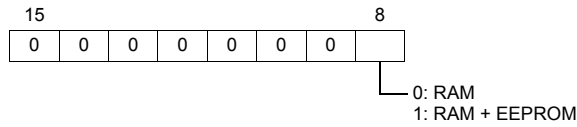

47.2.3 VF-S11

Communication Setting

Editor

Communication setting

(Underlined setting: default)

Item	Setting	Remarks
Connection Mode	1 : 1 / <u>1 : n</u> / Multi-link2 / Multi-link2 (Ethernet)	
Signal Level	RS-232C / <u>RS-422/485</u>	
Baud Rate	4800 / <u>9600</u> / 19200 bps	
Data Length	<u>8</u> bits	
Stop Bit	<u>1</u> / 2 bits	
Parity	None / Odd / <u>Even</u>	
Target Port No.	<u>0</u> to 31	

Inverter

Communication parameter

The communication parameters can be set using keys attached to the inverter.

Be sure to match the settings to those made on the [Communication Setting] tab window of the editor.

(Underlined setting: default)

Parameter	Indication	Item	Setting	Default
Communication	F800	Baud rate	2: 4800 bps <u>3: 9600 bps</u> 4: 19200 bps	3
	F801	Parity	0: None <u>1: Even</u> 2: Odd	1
	F802	Inverter number (station number)	<u>0</u> to 31	0
	F803	Communication error trip time	<u>0: Inactive</u> 1 to 100 seconds	0
	F805	Transmission latency setting	<u>0.00: Normal communication</u> 0.01 to 2.00 seconds	0.00
	F829	Communication protocol selection	<u>0: Toshiba inverter protocol</u> 1: MODBUS-RTU protocol	0

The data length is fixed to "8 bits".

Changes to parameters take effect when the power is turned off and on again.

RS4001Z: baud rate and terminating resistance setting switch

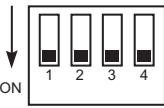
Switch	Contents	Setting	Setting Example									
1, 2	Baud rate *	<table border="1"> <thead> <tr> <th></th> <th>4800</th> <th>9600</th> </tr> </thead> <tbody> <tr> <td>SW1</td> <td>OFF</td> <td>ON</td> </tr> <tr> <td>SW2</td> <td>ON</td> <td>ON</td> </tr> </tbody> </table>		4800	9600	SW1	OFF	ON	SW2	ON	ON	 <p>Baud rate: 9600 bps Terminating resistance: Provided</p>
	4800	9600										
SW1	OFF	ON										
SW2	ON	ON										
3	Terminating resistance on the receiving side	ON: Provided OFF: Not provided										
4	Terminating resistance on the sending side	ON: Provided OFF: Not provided										

* Set the same baud rate as the one set for the communication parameter "F800" of the inverter.

RS4002Z: baud rate and bit length setting (SW1)

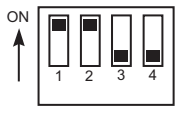
Switch	Contents	Setting	Setting Example																
1 to 3	Baud rate*1	<table border="1"> <tr> <td></td> <td>4800</td> <td>9600</td> <td>19200</td> </tr> <tr> <td>SW1</td> <td>OFF</td> <td>ON</td> <td>OFF</td> </tr> <tr> <td>SW2</td> <td>ON</td> <td>ON</td> <td>OFF</td> </tr> <tr> <td>SW3</td> <td>OFF</td> <td>OFF</td> <td>ON</td> </tr> </table>		4800	9600	19200	SW1	OFF	ON	OFF	SW2	ON	ON	OFF	SW3	OFF	OFF	ON	 <p>Baud rate: 9600 bps Bit length: 12 bits</p>
			4800	9600	19200														
		SW1	OFF	ON	OFF														
		SW2	ON	ON	OFF														
SW3	OFF	OFF	ON																
4	Bit length*2	ON: 11 bits OFF: 12 bits																	



*1 Set the same baud rate as the one set for the communication parameter "F800" of the inverter.

*2 When the parity is provided, set 12 bits.

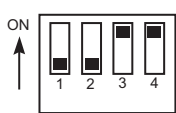
RS4002Z: wiring system and terminating resistance setting (SW2)

Switch	Contents	Setting	Setting Example									
1, 2	Wiring system	<table border="1"> <tr> <td></td> <td>4-wire system</td> <td>2-wire system</td> </tr> <tr> <td>SW1</td> <td>OFF</td> <td>ON</td> </tr> <tr> <td>SW2</td> <td>OFF</td> <td>ON</td> </tr> </table>		4-wire system	2-wire system	SW1	OFF	ON	SW2	OFF	ON	 <p>Wiring: 4-wire system Terminating resistance: Provided</p>
			4-wire system	2-wire system								
SW1	OFF	ON										
SW2	OFF	ON										
3	Terminating resistance on the receiving side	ON: Provided OFF: Not provided										
4	Terminating resistance on the sending side	ON: Provided OFF: Not provided										

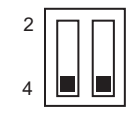
RS4003Z: wiring system (SW1), terminating resistance (SW2), and inverter number (SW5) setting

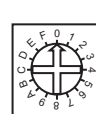
Switch	Contents	Setting	Setting Example
SW1	Wiring system*1	2: 2-wire system 4: 4-wire system	 <p>Wiring: 4-wire system</p>
SW2	R Terminating resistance on the receiving side	S: Terminating resistance provided O: Terminating resistance not provided	 <p>Terminating resistance: Provided</p>
	T Terminating resistance on the sending side	S: Terminating resistance provided O: Terminating resistance not provided	
SW5	Inverter number*2	0 to 15	 <p>Inverter number: 0</p>

*1 Set the both setting switches in the same positions.

*2 When "0" is selected, the setting of the inverter's communication parameter "F802" takes effect.

Available Memory

The available memory setting range varies depending on the device. Be sure to set within the range available with the device to be used. Use [TYPE] when assigning the indirect memory for macro programs.

Memory	TYPE	Remarks
--	00H	

Specify the storage target memory address on the [Memory Input] dialog.

RAM: Store in RAM

EEPROM: Store in RAM + EEPROM

Indirect Memory Designation

n + 0	15	Model (11 to 18)	8 7	Memory type	0
n + 1	Memory number (address)				
n + 2	Expansion code *		Bit designation		
n + 3	00		Station number		

* Specify the storage target memory address in the expansion code.

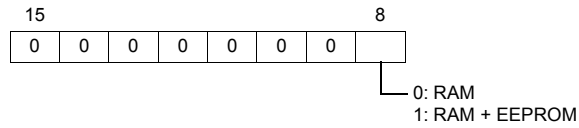

47.2.4 VF-A7

Communication Setting

Editor

Communication setting

(Underlined setting: default)

Item	Setting	Remarks
Connection Mode	1 : 1 / <u>1:n</u> / Multi-link2 / Multi-link2	
Signal Level	RS-232C / <u>RS-422/485</u>	
Baud Rate	4800 / <u>9600</u> / 19200 / 38400 bps	
Data Length	<u>8</u> bits	
Stop Bit	<u>1</u> / 2 bits	Fixed to "1" when 2-wire RS-485 connection is selected and the CPU version is V100 to V305
Parity	None / Odd / <u>Even</u>	
Target Port No.	<u>0</u> to 31	

Inverter

RS-485 Communication Port

Communication parameter

The communication parameters can be set using keys attached to the inverter.

Be sure to match the settings to those made on the [Communication Setting] tab window of the editor.

(Underlined setting: default)

Parameter	Indication	Item	Setting	Default
Communication	F801	Parity	0: None <u>1: Even</u> 2: Odd	1
	F802	Inverter number (station number)	<u>0</u> to 31	0
	F803	Communication timeout time	<u>0: OFF</u> 1 to 100 seconds	0
	F805	Transmission latency setting *1	<u>0.00: Normal communication</u> 0.01 to 2.00 seconds	0.00
	F820	Baud rate (RS-485 communication port)	2: 4800 bps <u>3: 9600 bps</u> 4: 19200 bps 5: 38400 bps	3
	F821	Wiring system	0: 2-wire system *2 <u>1: 4-wire system</u>	1
	F825	Transmission latency setting *1	<u>0.00: Normal communication</u> 0.01 to 2.00 seconds	0.00

*1 When the CPU version is V100, make a setting for F805. For any version other than V100, make a setting for F825.

*2 Not available with the CPU version of V300 or earlier. Use a 4-wire system for connection.

The data length is fixed to "8 bits".

Changes to parameters take effect when the power is turned off and on again.

Common Serial Communication Port (RS2001Z / RS4001Z)

When the common serial communication port is used, the communication conversion unit "RS2001Z" or "RS4001Z" is necessary.

Communication parameter

The communication parameters can be set using keys attached to the inverter.

Be sure to match the settings to those made on the [Communication Setting] tab window of the editor.

(Underlined setting: default)

Parameter	Indication	Item	Setting	Default
Communication	F800	Baud rate (Common serial)	2: 4800 bps <u>3: 9600 bps</u>	3
	F801	Parity	0: None <u>1: Even</u> 2: Odd	1
	F802	Inverter number (station number)	<u>0</u> to 31	0
	F803	Communication timeout time	<u>0</u> : OFF 1 to 100 seconds	0
	F805	Transmission latency setting	<u>0.00</u> : Normal communication 0.01 to 2.00 seconds	0.00

The data length is fixed to "8 bits".

Changes to parameters take effect when the power is turned off and on again.

RS4001Z: baud rate and terminating resistance setting switch

Switch	Contents	Setting	Setting Example									
1, 2	Baud rate *	<table border="1"> <thead> <tr> <th></th> <th>4800</th> <th>9600</th> </tr> </thead> <tbody> <tr> <td>SW1</td> <td>OFF</td> <td>ON</td> </tr> <tr> <td>SW2</td> <td>ON</td> <td>ON</td> </tr> </tbody> </table>		4800	9600	SW1	OFF	ON	SW2	ON	ON	 <p>Baud rate: 9600 bps Terminating resistance: Provided</p>
			4800	9600								
SW1	OFF	ON										
SW2	ON	ON										
3	Terminating resistance on the receiving side	ON: Provided OFF: Not provided										
4	Terminating resistance on the sending side	ON: Provided OFF: Not provided										

* Set the same baud rate as the one set for the communication parameter "F800" of the inverter.

Available Memory

The available memory setting range varies depending on the device. Be sure to set within the range available with the device to be used. Use [TYPE] when assigning the indirect memory for macro programs.

Memory	TYPE	Remarks
--	00H	

Specify the storage target memory address on the [Memory Input] dialog.

RAM: Store in RAM

EEPROM: Store in RAM + EEPROM

Indirect Memory Designation

	15	8	7	0
n + 0	Model (11 to 18)		Memory type	
n + 1	Memory number (address)			
n + 2	Expansion code *		Bit designation	
n + 3	00		Station number	

* In the expansion code, specify the storage target memory address, and set which word, higher or lower, is to be read when 2-word address is specified (expansion bit designation).

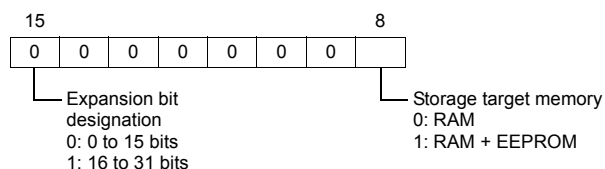

47.2.5 VF-AS1

Communication Setting

Editor

Communication setting

(Underlined setting: default)

Item	Setting	Remarks
Connection Mode	1 : 1 / <u>1:n</u> / Multi-link2 / Multi-link2 (Ethernet)	
Signal Level	<u>RS-422/485</u>	
Baud Rate	9600 / <u>19200</u> / 38400 bps	
Data Length	<u>8</u> bits	
Stop Bit	<u>1</u> / 2 bits	
Parity	None / Odd / <u>Even</u>	
Target Port No.	<u>0</u> to 31	

Inverter

2-wire RS-485 Communication Port

Communication parameter

The communication parameters can be set using keys attached to the inverter.

Be sure to match the settings to those made on the [Communication Setting] tab window of the editor.

(Underlined setting: default)

Parameter	Indication	Item	Setting	Default
Communication	F800	Baud rate (2-wire RS-485)	0: 9600 bps <u>1: 19200 bps</u> 2: 38400 bps	1
	F801	Parity (Common to 2-wire and 4-wire)	0: None <u>1: Even</u> 2: Odd	1
	F802	Inverter number (station number)	<u>0</u> to 31	0
	F803	Communication timeout time (Common to 2-wire and 4-wire)	<u>0: OFF</u> 1 to 100 seconds	0
	F805	Transmission latency setting (2-wire RS-485)	<u>0.00: Normal communication</u> 0.01 to 2.00 seconds	0.00
	F807	Communication protocol selection (2-wire RS-485)	<u>0: Toshiba inverter protocol</u> 1: MODBUS-RTU protocol	0

The data length is fixed to "8 bits".

Changes to parameters take effect when the power is turned off and on again.

4-wire RS-485 Communication Port

Communication parameter

The communication parameters can be set using keys attached to the inverter.

Be sure to match the settings to those made on the [Communication Setting] tab window of the editor.

(Underlined setting: default)

Parameter	Indication	Item	Setting	Default
Communication	F801	Parity (Common to 2-wire and 4-wire)	0: None <u>1: Even</u> 2: Odd	1
	F802	Inverter number (station number)	<u>0</u> to 31	0
	F803	Communication timeout time (Common to 2-wire and 4-wire)	<u>0: OFF</u> 1 to 100 seconds	0
	F820	Baud rate (4-wire RS-485)	0: 9600 bps <u>1: 19200 bps</u> 2: 38400 bps	1
	F825	Transmission latency setting (4-wire RS-485)	<u>0.00: Normal communication</u> 0.01 to 2.00 seconds	0.00
	F829	Communication protocol selection (4-wire RS-485)	<u>0: Toshiba inverter protocol</u> 1: MODBUS-RTU protocol	0

The data length is fixed to "8 bits".

Changes to parameters take effect when the power is turned off and on again.

Available Memory

The available memory setting range varies depending on the device. Be sure to set within the range available with the device to be used. Use [TYPE] when assigning the indirect memory for macro programs.

Memory	TYPE	Remarks
--	00H	

Specify the storage target memory address on the [Memory Input] dialog.

RAM: Store in RAM

EEPROM: Store in RAM + EEPROM

Indirect Memory Designation

	15	8	7	0
n + 0	Model (11 to 18)		Memory type	
n + 1	Memory number (address)			
n + 2	Expansion code *		Bit designation	
n + 3	00		Station number	

* Specify the storage target memory address in the expansion code.

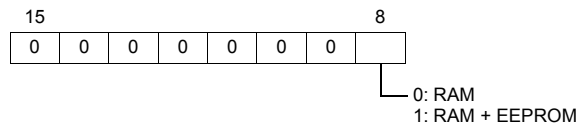

47.2.6 VF-P7

Settings are the same as those described in “47.2.4 VF-A7”.

47.2.7 VF-PS1

Settings are the same as those described in “47.2.5 VF-AS1”.

47.2.8 VF-FS1

Communication Setting

Editor

Communication setting

(Underlined setting: default)

Item	Setting	Remarks
Connection Mode	1 : 1 / <u>1:n</u> / Multi-link2 / Multi-link2 (Ethernet)	
Signal Level	<u>RS-422/485</u>	
Baud Rate	9600 / <u>19200</u> bps	
Data Length	<u>8</u> bits	
Stop Bit	<u>1</u> / 2 bits	
Parity	None / Odd / <u>Even</u>	
Target Port No.	<u>0</u> to 31	

Inverter

Communication parameter

The communication parameters can be set using keys attached to the inverter.

Be sure to match the settings to those made on the [Communication Setting] tab window of the editor.

(Underlined setting: default)

Parameter	Indication	Item	Setting	Default
Communication	F800	Baud rate	0: 9600 bps <u>1: 19200 bps</u>	1
	F801	Parity	0: None <u>1: Even</u> 2: Odd	1
	F802	Inverter number (station number)	<u>0</u> to 31	0
	F803	Communication timeout time	<u>0</u> : OFF 1 to 100 seconds	0
	F805	Transmission latency setting	<u>0.00</u> : Normal communication 0.01 to 2.00 seconds	0.00
	F829	Communication protocol selection	<u>0</u> : Toshiba inverter protocol 1: MODBUS-RTU protocol	0

The data length is fixed to "8 bits".

Changes to parameters take effect when the power is turned off and on again.

Available Memory

The available memory setting range varies depending on the device. Be sure to set within the range available with the device to be used. Use [TYPE] when assigning the indirect memory for macro programs.

Memory	TYPE	Remarks
--	00H	

Specify the storage target memory address on the [Memory Input] dialog.

RAM: Store in RAM

EEPROM: Store in RAM + EEPROM

Indirect Memory Designation

	15	8	7	0
n + 0	Model (11 to 18)		Memory type	
n + 1	Memory number (address)			
n + 2	Expansion code *		Bit designation	
n + 3	00		Station number	

* Specify the storage target memory address in the expansion code.

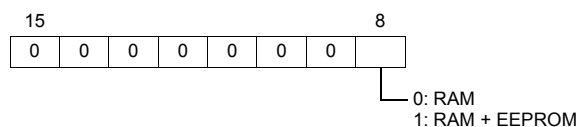

47.2.9 VF-nC1

Communication Setting

Editor

Communication setting

(Underlined setting: default)

Item	Setting	Remarks
Connection Mode	1 : 1 / <u>1:n</u> / Multi-link2 / Multi-link2 (Ethernet)	
Signal Level	RS-232C / <u>RS-422/485</u>	
Baud Rate	4800 / <u>9600</u> / 19200 bps	
Data Length	<u>8</u> bits	
Stop Bit	<u>1</u> / 2 bits	
Parity	None / Odd / <u>Even</u>	
Target Port No.	<u>0</u> to 31	

Inverter

Communication parameter

The communication parameters can be set using keys attached to the inverter.

Be sure to match the settings to those made on the [Communication Setting] tab window of the editor.

(Underlined setting: default)

Parameter	Indication	Item	Setting	Default
Communication	F800	Baud rate	2: 4800 bps 3: <u>9600 bps</u> 4: 19200 bps	3
	F801	Parity	0: None 1: <u>Even</u> 2: Odd	1
	F802	Inverter number (station number)	<u>0</u> to 31	0
	F803	Communication timeout time	<u>0</u> : OFF 1 to 100 seconds	0

The data length is fixed to "8 bits".

Changes to parameters take effect when the power is turned off and on again.

RS4001Z: baud rate and terminating resistance setting switch

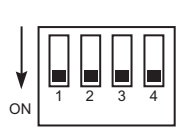
Switch	Contents	Setting	Setting Example									
1, 2	Baud rate *	<table border="1"> <thead> <tr> <th></th> <th>4800</th> <th>9600</th> </tr> </thead> <tbody> <tr> <td>SW1</td> <td>OFF</td> <td>ON</td> </tr> <tr> <td>SW2</td> <td>ON</td> <td>ON</td> </tr> </tbody> </table>		4800	9600	SW1	OFF	ON	SW2	ON	ON	 <p>Baud rate: 9600 bps Terminating resistance: Provided</p>
	4800	9600										
SW1	OFF	ON										
SW2	ON	ON										
3	Terminating resistance on the receiving side	ON: Provided OFF: Not provided										
4	Terminating resistance on the sending side	ON: Provided OFF: Not provided										

* Set the same baud rate as the one set for the communication parameter "F800" of the inverter.

RS4002Z: baud rate and bit length setting switch

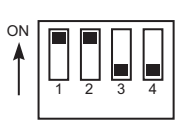
Switch	Contents	Setting	Setting Example																
1 to 3	Baud rate *1	<table border="1"> <thead> <tr> <th></th> <th>4800</th> <th>9600</th> <th>19200</th> </tr> </thead> <tbody> <tr> <td>SW1</td> <td>OFF</td> <td>ON</td> <td>OFF</td> </tr> <tr> <td>SW2</td> <td>ON</td> <td>ON</td> <td>OFF</td> </tr> <tr> <td>SW3</td> <td>OFF</td> <td>OFF</td> <td>ON</td> </tr> </tbody> </table>		4800	9600	19200	SW1	OFF	ON	OFF	SW2	ON	ON	OFF	SW3	OFF	OFF	ON	 <p>Baud rate: 9600 bps Bit length: 12 bits</p>
	4800	9600	19200																
SW1	OFF	ON	OFF																
SW2	ON	ON	OFF																
SW3	OFF	OFF	ON																
4	Bit length *2	ON: 11 bits OFF: 12 bits																	

*1 Set the same baud rate as the one set for the communication parameter "F800" of the inverter.

*2 When the parity is provided, set 12 bits.

RS4002Z: wiring system and terminating resistance setting switch

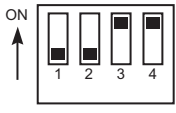
Switch	Contents	Setting	Setting Example									
1, 2	Wiring system	<table border="1"> <thead> <tr> <th></th> <th>4-wire system</th> <th>2-wire system</th> </tr> </thead> <tbody> <tr> <td>SW1</td> <td>OFF</td> <td>ON</td> </tr> <tr> <td>SW2</td> <td>OFF</td> <td>ON</td> </tr> </tbody> </table>		4-wire system	2-wire system	SW1	OFF	ON	SW2	OFF	ON	 <p>Wiring: 4-wire system Terminating resistance: Provided</p>
	4-wire system	2-wire system										
SW1	OFF	ON										
SW2	OFF	ON										
3	Terminating resistance on the receiving side	ON: Provided OFF: Not provided										
4	Terminating resistance on the sending side	ON: Provided OFF: Not provided										

Available Memory

The available memory setting range varies depending on the device. Be sure to set within the range available with the device to be used. Use [TYPE] when assigning the indirect memory for macro programs.

Memory	TYPE	Remarks
--	00H	

Specify the storage target memory address on the [Memory Input] dialog.

RAM: Store in RAM
EEPROM: Store in RAM + EEPROM

Indirect Memory Designation

	15	8 7	0
n + 0	Model (11 to 18)		Memory type
n + 1	Memory number (address)		
n + 2	Expansion code *		Bit designation
n + 3	00		Station number

* Specify the storage target memory address in the expansion code.

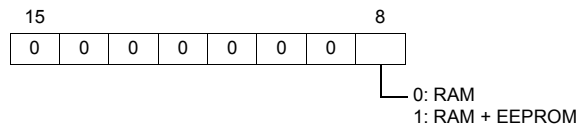

47.2.10 Wiring Diagrams

When Connected at COM1:

RS-422/RS-485

Wiring diagram 1 - COM1

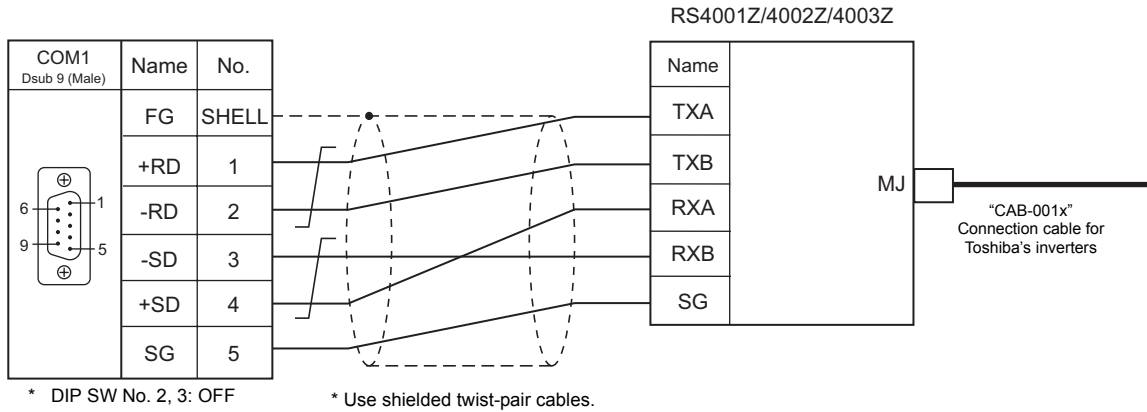

Wiring diagram 2 - COM1

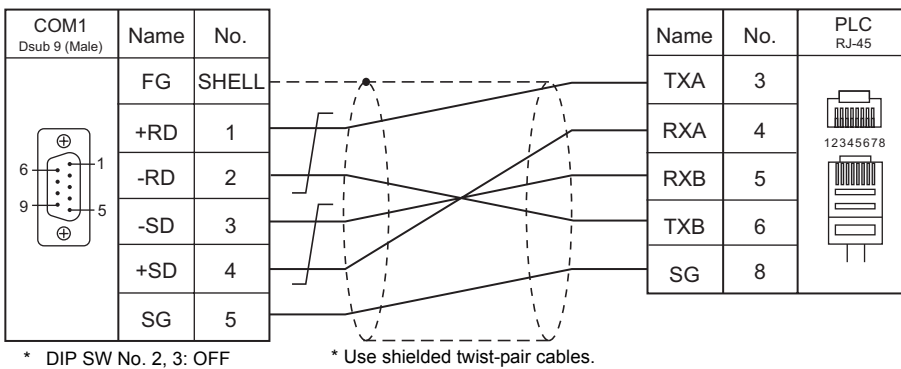

Wiring diagram 3 - COM1

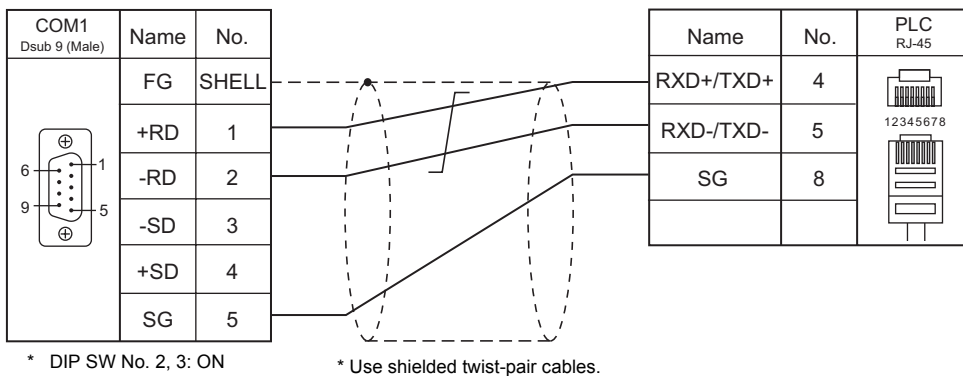

When Connected at COM2:

RS-232C

Wiring diagram 1 - COM2

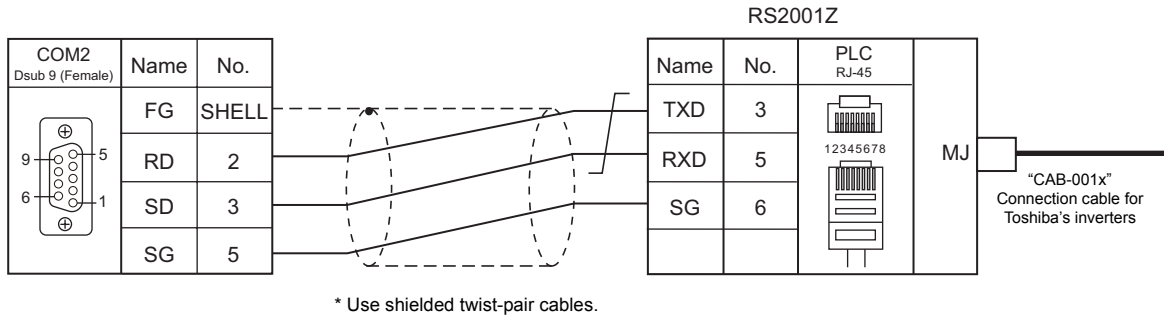

Wiring diagram 2 - COM2

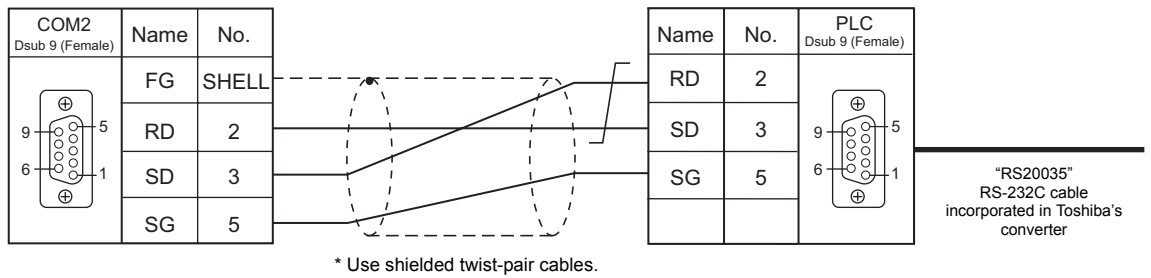

When Connected at COM3:

RS-485

Wiring diagram 1 - COM3

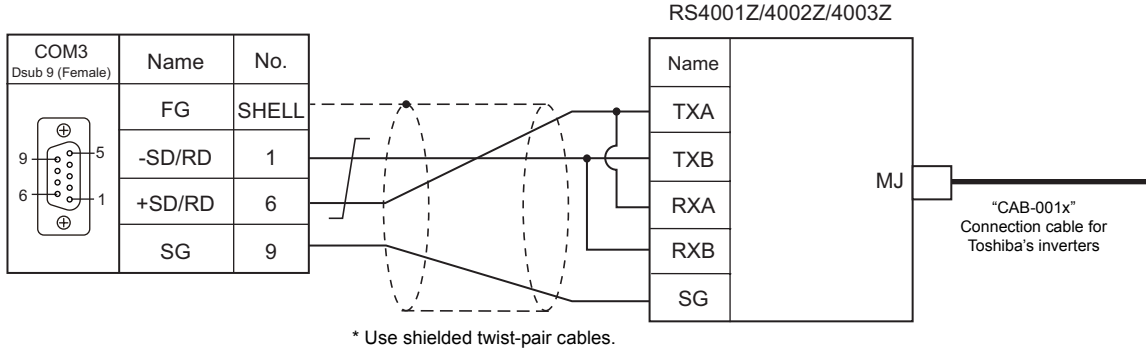

Wiring diagram 2 - COM3

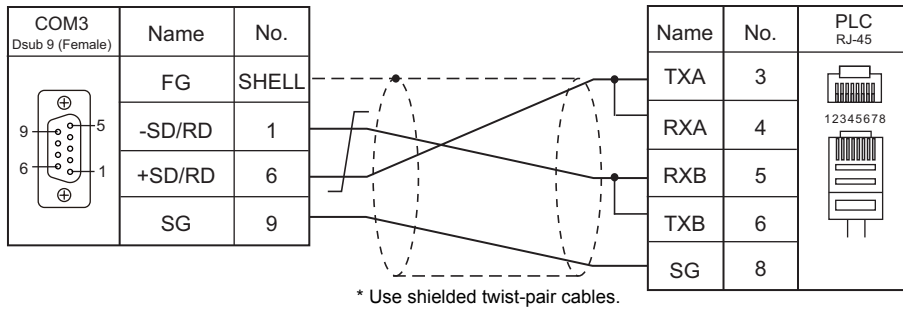

Wiring diagram 3 - COM3

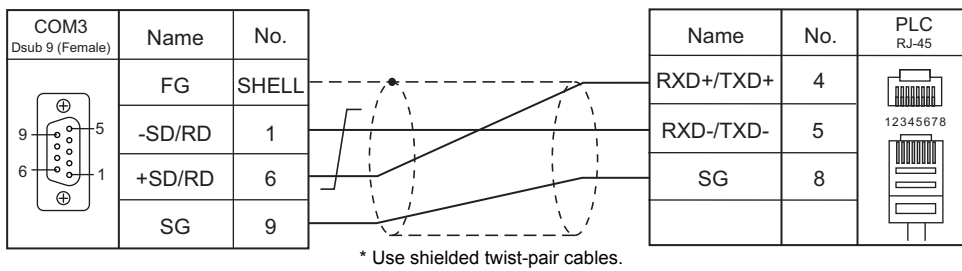

48. TOSHIBA MACHINE

48.1 PLC Connection

48.2 Temperature Controller/Servo/Inverter Connection

48.1 PLC Connection

Serial Connection

PLC Selection on the Editor	CPU		Unit/Port		Signal Level	TS Port	Connection	Ladder Transfer ^{*4}
TC200	TC200	TCCUH	Port of the CPU	RS-232C port	RS-232C	COM2	Wiring diagram 1 - COM2	×
			TCCMW TCCMO					
		TCCUHS TCCUHSC TCCUHSAC	Port of the CPU					
			TCCMWA TCCMWS TCCMOA TC232CA					
	TCmini	TC3-01	CN16	RS-232C	COM2	Wiring diagram 1 - COM2		
				CN17A CN17B	RS-485 ^{*1}	COM1	Wiring diagram 1 - COM1	
					COM3	Wiring diagram 1 - COM3		
		TC3-02	CN18	RS-232C	COM2	Wiring diagram 1 - COM2		
				CN20A CN20B	RS-485 ^{*2}	COM1	Wiring diagram 2 - COM1	
					COM3	Wiring diagram 2 - COM3		
		TC5-02	CN18	RS-232C	COM2	Wiring diagram 1 - COM2		
				CN24A CN24B	RS-485	COM1	Wiring diagram 3 - COM1	
					COM3	Wiring diagram 3 - COM3		
		TC5-03	CN13	RS-232C	COM2	Wiring diagram 1 - COM2		
				CN14 CN18	RS-485	COM1	Wiring diagram 2 - COM1	
					COM3	Wiring diagram 2 - COM3		
		TC8-00	CN13	RS-232C	COM2	Wiring diagram 1 - COM2		
CN11	RS-485 ^{*3}			COM1	Wiring diagram 4 - COM1			
	COM3			Wiring diagram 4 - COM3				
TC9-00	CN11	RS-485	COM1	Wiring diagram 3 - COM1				
		COM3	Wiring diagram 3 - COM3					

*1 CPUs version LT3CU01-D0 or later support RS-485. Check the CPU version.

*2 CPUs version LT3CU02-F0 or later support RS-485. Check the CPU version.

*3 CPUs version LT8CU00-A0 or later support RS-485. Check the CPU version.

*4 For the ladder transfer function, see "Appendix 5 Ladder Transfer Function".

48.1.1 TC200

Communication Setting

Editor

Communication setting

(Underlined setting: default)

Item	Setting	Remarks
Connection Mode	<u>1</u> : 1 / 1 : n / Multi-link2 / Multi-link2 (Ethernet) / 1 : n Multi-link2 (Ethernet)	
Signal Level	<u>RS-232C</u> / RS-422/485	*1
Baud Rate	<u>9600</u> / 19200 / 38400 / 57600 / 115200 bps	
Parity	<u>None</u>	
Data Length	<u>8</u> bits	
Stop Bit	<u>2</u> bits	

*1 For RS-422/485 communications, set a transmission delay time to 4 msec or longer.

TC200

TCCUH

Make the setting for communication using the ladder tool.

(Underlined setting: default)

Item	Setting	Remarks
Baud Rate	<u>9600</u> / 19200 bps	Set the baud rate in the system flag "A00F" OFF: 9600 bps ON: 19200 bps
Parity	<u>None</u>	
Data Length	<u>8</u> bits	
Stop Bit	<u>2</u> bit	
Station Number	<u>1</u>	

Parity: none, data length: 8 bits, stop bit: 2 bits, station No. 1 (fixed)

TCCMW / TCCMO

No particular setting is necessary on the PLC. The PLC always performs communication functions using the following parameters. Be sure to match the settings to those made on the [Communication Setting] tab window of the editor.

Item	Setting	Remarks
Baud Rate	9600 bps	
Parity	None	
Data Length	8 bits	
Stop Bit	2 bit	
Station Number	1	

All PLC parameters are fixed.

Function setting switch (MODE)

Switch	Setting	Remarks
3	ON	Link master station
4	OFF	Link slave station
5	OFF	Remote master station
6	OFF	Remote slave station

When this switch is OFF, communications between TS and PLC are not possible.

TCCUHS / TCCUHSC / TCCUHSAC

Set the communication format in the application software.

(Underlined setting: default)

Item	Setting	Remarks			
Baud rate	<u>9600</u> / 19200 / 38400 / 57600 / 115200 bps	System Flag			Baud Rate (bps)
		A00F	A154	A155	
		0	0	0	9600
		1	0	0	19200
		-	1	0	38400
	0	1	57600		
	1	1	115200		

Parity: none, data length: 8 bits, stop bit: 2 bits, station No. 1 (fixed)

TCCMWA / TCCMWS / TCCMOA / TC232CA

Be sure to match the settings to those made on the [Communication Setting] tab window of the editor.

Item	Setting	Remarks
Baud rate	9600 / 19200 / 38400 / 57600 bps	57600 bps not supported by TC232CA

Parity: none, data length: 8 bits, stop bit: 2 bits, station No. 1 (fixed)

Function setting switches (MODE)

Switch	ON/OFF	Setting	Remarks
3	ON	Link master station	Communication disabled with this switch set to OFF
4	OFF	Link slave station	
5	OFF	Remote master station	
6	OFF	Remote slave station	

TCmini

TC3-01

CN16

Parity: none, data length: 8 bits, stop bit: 2 bits, station No. 1 (fixed)

Because of the baud rate auto-detection feature (4800/9600/19200/38400 bps), no baud rate setting is needed on the PLC.

CN17A/CN17B

Parity: none, data length: 8 bits, stop bit: 2 bits, station No. 1 (fixed)

Because of the baud rate auto-detection feature (4800/9600/19200/38400 bps), no baud rate setting is needed on the PLC.

Setting Item	Register	Contents	Setting	Remarks
Software setting	D11F	Mode setting	4: Host communication mode	Setting changes take effect when the power is turned off and on again.

Setting Item	Jumper	Item	Setting	
Hardware setting	JP2	Terminating resistance	With terminating resistance	JP2: Jumper
	JP3	Half duplex / full duplex selection	Half duplex	JP3: Jumper
	JP4			JP4: Jumper
	JP15			Jumper across pins 2 and 3 of JP15

TC3-02**CN18**

Parity: none, data length: 8 bits, stop bit: 2 bits, station No. 1 (fixed)

Because of the baud rate auto-detection feature (4800/9600/19200/38400 bps), no baud rate setting is needed on the PLC.

CN20A/CN20B

Parity: none, data length: 8 bits, stop bit: 2 bits, station No. 1 (fixed)

Because of the baud rate auto-detection feature (4800/9600/19200/38400 bps), no baud rate setting is needed on the PLC.

Setting Item	Register	Contents	Setting	Remarks
Software setting	D26F	Mode setting	4: Host communication mode	Setting changes take effect when the power is turned off and on again.

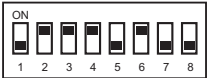
Setting Item	DIP Switch (SW2)	Contents	Setting												
Hardware setting		SW2-1 SW2-2 SW2-3 SW2-4 SW2-7	Half duplex / full duplex selection												
		SW2-6	Terminating resistance												
			<table border="1"> <thead> <tr> <th></th> <th>SW2-1</th> <th>SW2-2</th> <th>SW2-3</th> <th>SW2-4</th> <th>SW2-7</th> </tr> </thead> <tbody> <tr> <td>Half duplex</td> <td>OFF</td> <td>ON</td> <td>ON</td> <td>ON</td> <td>OFF</td> </tr> </tbody> </table>		SW2-1	SW2-2	SW2-3	SW2-4	SW2-7	Half duplex	OFF	ON	ON	ON	OFF
	SW2-1	SW2-2	SW2-3	SW2-4	SW2-7										
Half duplex	OFF	ON	ON	ON	OFF										
			ON: Provided												

TC5-02**CN18**

Parity: none, data length: 8 bits, stop bit: 2 bits, station No. 1 (fixed)

Because of the baud rate auto-detection feature (9600/19200/38400 bps), no baud rate setting is needed on the PLC.

CN24A/CN24B

Setting Item	Register	Contents	Setting	Remarks
Software setting	D37E	Baud rate setting	0: 9600 bps 1: 19200 bps 2: 38400 bps	Setting changes take effect when the power is turned off and on again.
	D37F	Mode setting	3: Host communication mode	

Parity: none, data length: 8 bits, stop bit: 2 bits, station No. 1 (fixed)

Setting Item	DIP Switch (SW2)	Contents	Setting
Hardware setting		SW2-7	Terminating resistance
			ON: Provided

TC5-03**CN13**

Parity: none, data length: 8 bits, stop bit: 2 bits, station No. 1 (fixed)

Because of the baud rate auto-detection feature (9600/19200/38400 bps), no baud rate setting is needed on the PLC.

CN14/CN18

Setting Item	Register	Contents	Setting	Remarks
Software setting	D37E	Baud rate setting	0: 9600 bps 1: 19200 bps 2: 38400 bps	Setting changes take effect when the power is turned off and on again.
	D37F	Mode setting	3: Host communication mode	

Parity: none, data length: 8 bits, stop bit: 2 bits, station No. 1 (fixed)

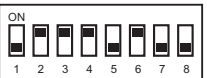
Setting Item	DIP Switch (SW1)	Contents	Setting												
Hardware setting		SW1-1 SW1-2 SW1-3 SW1-4 SW1-7	Half duplex / full duplex selection												
		SW1-6	Terminating resistance												
			<table border="1"> <thead> <tr> <th></th> <th>SW1-1</th> <th>SW1-2</th> <th>SW1-3</th> <th>SW1-4</th> <th>SW1-7</th> </tr> </thead> <tbody> <tr> <td>Half duplex</td> <td>OFF</td> <td>ON</td> <td>ON</td> <td>ON</td> <td>OFF</td> </tr> </tbody> </table>		SW1-1	SW1-2	SW1-3	SW1-4	SW1-7	Half duplex	OFF	ON	ON	ON	OFF
	SW1-1	SW1-2	SW1-3	SW1-4	SW1-7										
Half duplex	OFF	ON	ON	ON	OFF										
			ON: Provided												

TC8-00**CN13**

Parity: none, data length: 8 bits, stop bit: 2 bits, station No. 1 (fixed)

Because of the baud rate auto-detection feature (9600/19200/38400 bps), no baud rate setting is needed on the PLC.

CN11

Parity: none, data length: 8 bits, stop bit: 2 bits, station No. 1 (fixed)

Because of the baud rate auto-detection feature (9600/19200/38400 bps), no baud rate setting is needed on the PLC.

Setting Item	Register	Contents	Setting	Remarks
Software setting	D37F	Mode setting	8004H: Host communication mode	Setting changes take effect when the power is turned off and on again.

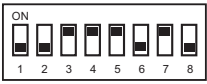
Setting Item	DIP Switch (SW5)	Contents	Setting						
			SW5-1	SW5-2	SW5-3	SW5-4	SW5-5		
Hardware setting		SW5-1 SW5-2 SW5-3 SW5-4 SW5-5	Half duplex / full duplex selection	Half duplex	OFF	OFF	ON	ON	ON
		SW5-7	Terminating resistance	ON: Provided					

TC9-00**CN11**

Setting Item	Register	Contents	Setting	Remarks
Software setting	D12E	Baud rate setting	0: 9600 bps 1: 19200 bps 2: 38400 bps	Setting changes take effect when the power is turned off and on again.
	D12F	Mode setting	0: Host communication mode	

Parity: none, data length: 8 bits, stop bit: 2 bits, station No. 1 (fixed)

Available Memory

The available memory setting range varies depending on the PLC model. Be sure to set within the range available for the PLC. Use [TYPE] when assigning the indirect memory for macro programs.

Memory	TYPE	Remarks
D (universal register 1)	00H	
B (universal register 2)	01H	
X (input relay)	02H	XW as word device
Y (output relay)	03H	YW as word device
R (internal relay)	04H	RW as word device
G (extension internal relay 1)	05H	GW as word device
H (extension internal relay 2)	06H	HW as word device
L (latch relay)	07H	LW as word device
S (shift register)	08H	SW as word device
E (edge relay)	09H	EW as word device
P (timer counter register 1/current value)	0AH	
V (timer counter register 2/set value)	0BH	
T (timer/contact)	0CH	TW as word device
C (counter/contact)	0DH	CW as word device
A (special auxiliary relay)	0EH	AW as word device
U (universal register 3)	0FH	TCCMWA / TCCMWS / TCCMOA / TC232CA only
M (universal register 4)	10H	TCCMWA / TCCMWS / TCCMOA / TC232CA only
Q (universal register 5)	11H	TCCMWA / TCCMWS / TCCMOA / TC232CA only
I (input relay 2)	12H	IW as word device; supported by TCCMWA / TCCMWS / TCCMOA / TC232CA only
O (output relay 2)	13H	OW as word device; supported by TCCMWA / TCCMWS / TCCMOA / TC232CA only
J (extension internal relay 3)	14H	JW as word device; supported by TCCMWA / TCCMWS / TCCMOA / TC232CA only
K (extension internal relay 4)	15H	KW as word device; supported by TCCMWA / TCCMWS / TCCMOA / TC232CA only

Address denotations

Ex.) F70

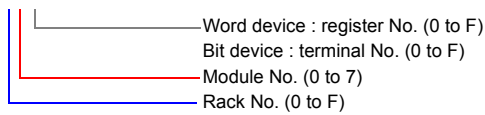

Indirect Memory Designation

	15	8	7	0
n+0	Models		Memory Type	
n+1	Address No. (word designation)			
n+2	00		Bit designation	
n+3	00		Station number	

Address No. (n+1)

- Word device (D, B, V, P, U, M, Q)

15	14	13	12	11	10	9	8	7	6	5	4	3	2	1	0
Not used					Rack No.			Module No.			Resister No.				

Ex.) D 052F (Rack No. 5, Module No. 2, Resister No. F)
 $n+1 = 0000\ 0010\ 1010\ 1111(\text{BIN}) = 02AF(\text{HEX})$

- Bit device (X, Y, R, G, H, L, S, E, T, C, A, I, O, J, K)

15	14	13	12	11	10	9	8	7	6	5	4	3	2	1	0
Not used								Rack No.			Module No.				

Ex.) R 0F1A (Rack No. F, Module No. 1, Terminal No. A)
 $n+1 = 0000\ 0000\ 0111\ 1001(\text{BIN}) = 0079(\text{HEX})$

Bit designation (n+2)

- When you use the command of BSET/BCLR/BINV, set the terminal No.

Ex.) R 0F1A (Rack No. F, Module No. 1, terminal No. A)
 $n+2 = 000A(\text{HEX})$

48.1.2 Wiring Diagrams

When Connected at COM1:

RS-485

Wiring diagram 1 - COM1

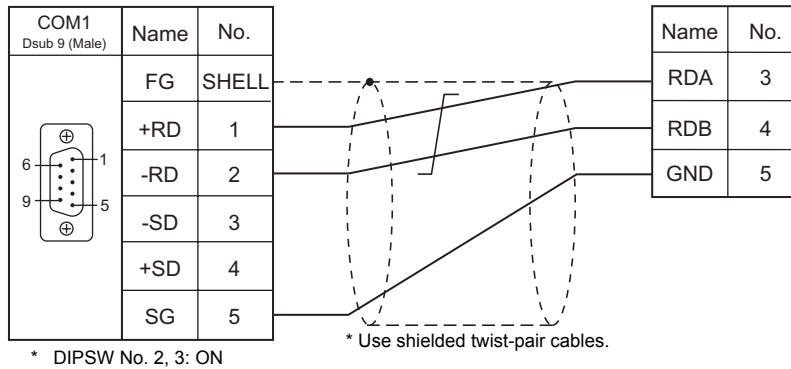

Wiring diagram 2 - COM1

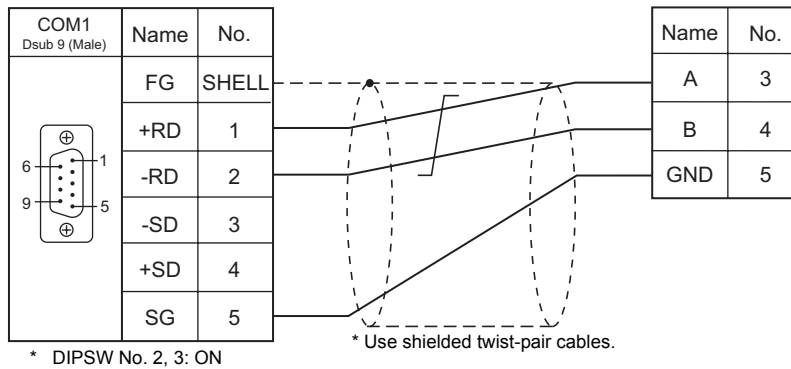

Wiring diagram 3 - COM1

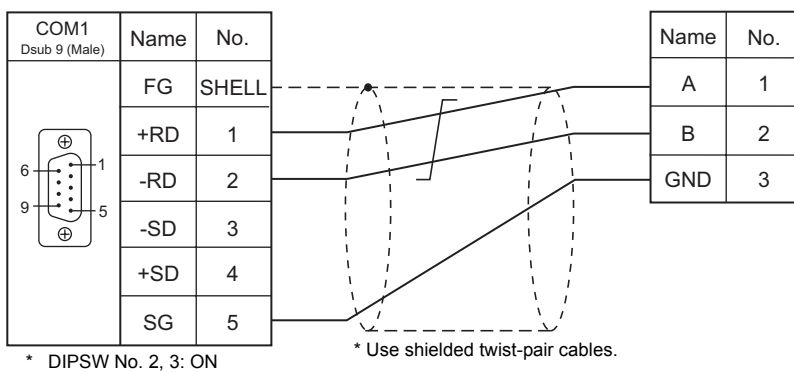

Wiring diagram 4 - COM1

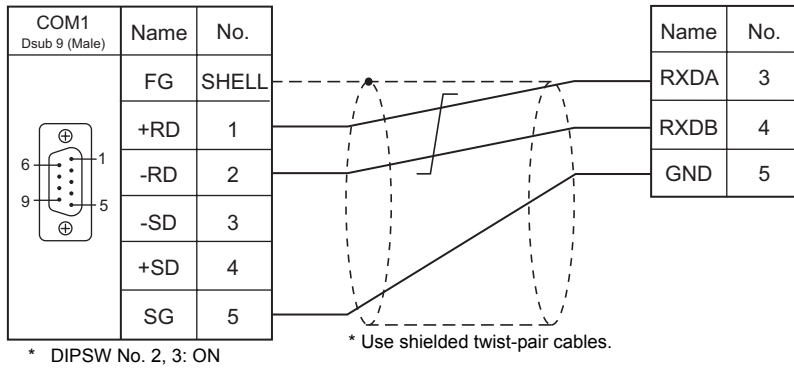

When Connected at COM2:

RS-232C

Wiring diagram 1 - COM2

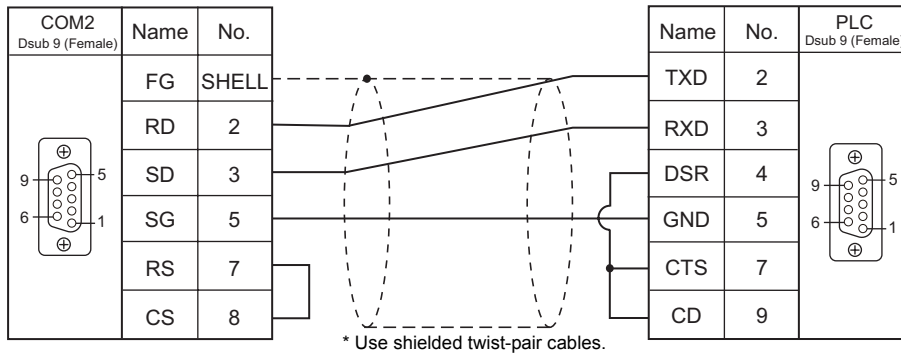

When Connected at COM3:

RS-485

Wiring diagram 1 - COM3

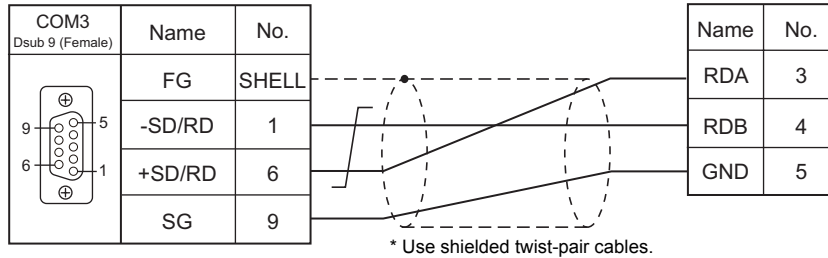

Wiring diagram 2 - COM3

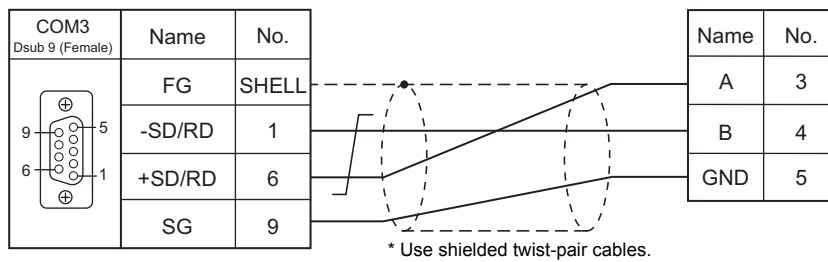

Wiring diagram 3 - COM3

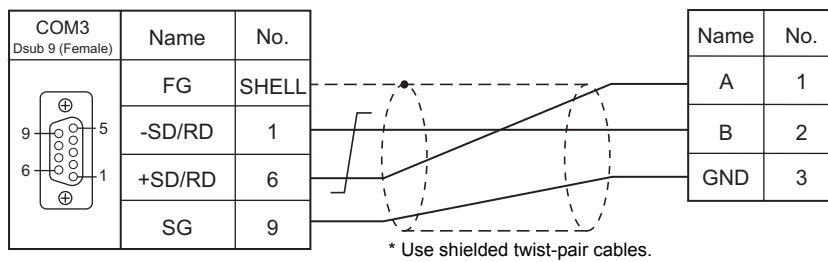

Wiring diagram 4 - COM3

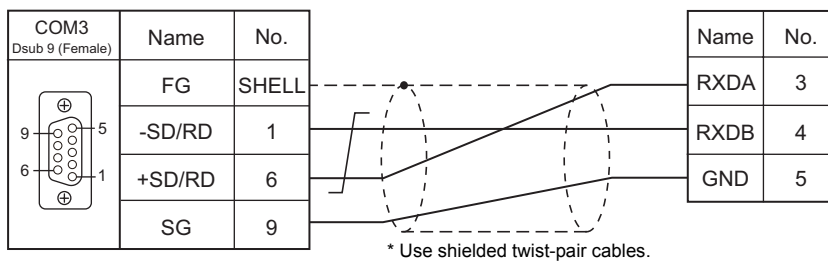

48.2 Temperature Controller/Servo/Inverter Connection

The controller models shown below can be connected.

Servo Amplifier

PLC Selection on the Editor	Model		Port	Signal Level	TS Port	Connection	Lst File
VELCONIC series	NCBOY-80	VLPSX-xxxPx-xRx	CN14	RS-422	COM1	Wiring diagram 1 - COM1	-
				RS-485	COM3	Wiring diagram 1 - COM3	

48.2.1 VELCONIC Series

Communication Setting

Editor

Communication setting

(Underlined setting: default)

Item	Setting	Remarks
Connection Mode	<u>1</u> : n	
Signal Level	<u>RS-422/485</u>	
Baud Rate	<u>4800</u> / 9600 / 19200 / 38400 / 57600 / 115K bps	
Parity	<u>None</u> / Odd / Even	
Data Length	7 / <u>8</u> bits	
Stop Bit	<u>1</u> / 2 bits	

Servo Amplifier

Parameter

The communication parameters can be set using keys attached to the servo amplifier. Set the following parameters on the [Communication Setting] tab window of the editor.

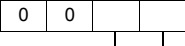
Parameter	Item	Setting	Remarks
A.n-	Axis number	0 to 63	
PP45	Baud rate setting	<u>0</u> : 4800 bps 1: 9600 bps 2: 19.2k bps 3: 38.4k bps 4: 57.6k bps 6: 115.2k bps	
PP48	RS-485 setting	 <p>Parity <u>0</u>: None 1: Even 2: Odd</p> <p>Stop bit <u>0</u>: 1 bit 1: 2 bits</p>	The setting takes effect when the power is turned off and back on again.
UP01	Control mode	<u>23</u> : RS-485 (VLBus-A)	

Terminating resistance setting (SW1)

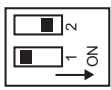
SW1		Item	Setting	
	SW1-1 SW1-2	Terminating resistance		
			When one unit is connected	When multiple units are connected
			SW1-1	OFF
SW1-2	ON	ON		

Available Memory

The macro commands "PLC_CTL" is used for reading and writing data.
For more information on the macro command, see "PLC_CTL" (page 48-12).

PLC_CTL

Macro command "PLC_CTL F0 F1 F2"

Contents	F0	F1 (= \$u n)														F2	
Memory information designation	1 - 8 (PLC1 - 8)	n	Station number: 0000 to 003F (H)														7
		n + 1	Command: 000C (H)														
		n + 2	Data to write (D1/D0)														
			D1							D0							
		15	14	13	12	11	10	9	8	7	6	5	4	3	2	1	
n + 3	Data to write (D3/D2)																
	D3							D2									
15	14	13	12	11	10	9	8	7	6	5	4	3	2	1	0	Bit 0 to 5, 8 to 15: IN40 to IN4D : OVR0 to OVR13 (override) Bit 6: IN4E : - Bit 7: IN4F : DCNT (start signal confirm)	
n + 4 to n + 5	Data to write (D7/D6/D5/D4)																
	D7				D6				D5				D4				
31 to 24	23 to 16				15 to 8				7 to 0				Bit 0 to 31: IN20 to IN3F : PCMD0 to PCMD31 (position command)				
n + 6	Data to write (D9/D8)																
	D9							D8									
15	14	13	12	11	10	9	8	7	6	5	4	3	2	1	0	Bit 0: IN18 : TEACH (teaching) Bit 1: IN19 : MODE0 (operation mode) Bit 2: IN1A : MODE1 (operation mode) Bit 3: IN1B : CSEL0 (command select) Bit 4: IN1C : CSEL1 (command select) Bit 5: IN1D : FSEL0 (speed select) Bit 6: IN1E : FSEL1 (speed select) Bit 7: IN1F : PCLR (current value clear) Bit 8: IN10 : RUN (running) Bit 9: IN11 : RESET (reset) Bit 10: IN12 : START (start) Bit 11: IN13 : JOGP (jog +) Bit 12: IN14 : JOGM (jog -) Bit 13: IN15 : FSTP (temporary stop) Bit 14: IN16 : LSSEL (LS positioning select) Bit 15: IN17 : ECLR (deviation counter clear)	

Contents	F0	F1 (= \$u n)													F2			
Memory information designation	1 - 8 (PLC1 - 8)	n + 7	Data to read (D1'/D0') *													7		
		D1'						D0'										
		15	14	13	12	11	10	9	8	7	6	5	4	3	2		1	0
		Bit 0 to 7: OUT58 to OUT5F : MIN0 to MIN7 (IN0 to IN7: input monitor) Bit 8 to 14: OUT50 to OUT56 : PN0 to PN6 (point number) Bit 15: OUT57 : RPAFIN (respond to parameter change)																
n + 8	Data to read (D3'/D2') *																	
D3'						D2'												
15	14	13	12	11	10	9	8	7	6	5	4	3	2	1	0			
Bit 0 to 15: OUT40 to OUT4F : FEED0 to FEED15 / CURR0 to CURR15 (number of rotations/current)																		
n + 9 to n + 10	D7'				D6'				D5'				D4'					
31 to 24				23 to 16				15 to 8				7 to 0						
Bit 0 to 31: OUT20 to OUT3F : POSI0 to POSI31 (current value)																		
n + 11	Data to read (D9'/D8') *																	
D9'						D8'												
15	14	13	12	11	10	9	8	7	6	5	4	3	2	1	0			
Bit 0: OUT18 : LSALM (LS error) Bit 1: OUT19 : TENBL (teaching enabled) Bit 2: OUT1A : BLV (battery voltage drop) Bit 3: OUT1B : WARN (warning) Bit 4: OUT1C : POK (positioning OK) Bit 5: OUT1D : MFEED (rotation monitor) Bit 6: OUT1E : MCURR (current monitor) Bit 7: OUT1F : SSTP (stopped due to error) Bit 8: OUT10 : SST (servo normal output) Bit 9: OUT11 : SRDY (servo ready) Bit 10: OUT12 : GRUN (servo locked) Bit 11: OUT13 : MZM (home position memorize in progress) Bit 12: OUT14 : HOME (stopped at home position) Bit 13: OUT15 : DEN (operation finish) Bit 14: OUT16 : INP (in position) Bit 15: OUT17 : AFSTP / CLA (temporarily stopped/current control in progress)																		

Return data: Data stored from servo amplifier to TS series

* Data must be written before executing reading of data. Specify control values of the servo amplifier for the memory address of data to write (n + 2 to n + 6). Then data is stored in the memory address of data to read (n + 7 to n + 11).

48.2.2 Wiring Diagrams

When Connected at COM1:

RS-422

Wiring diagram 1 - COM1

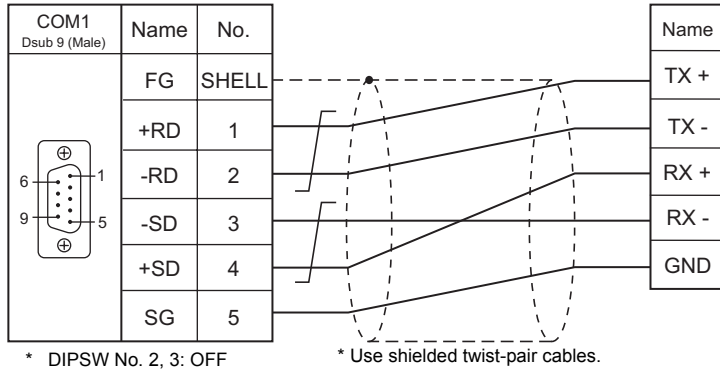

When Connected at COM3:

RS-485

Wiring diagram 1 - COM3

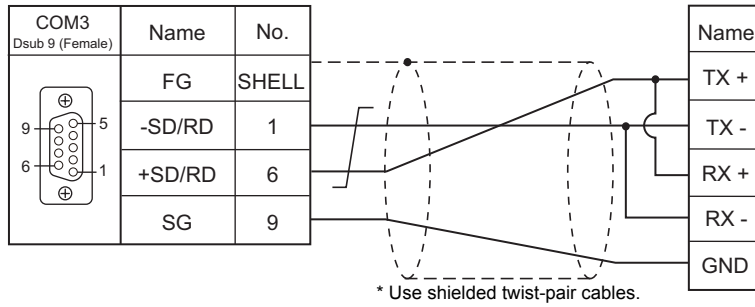

49. UNIPULSE

49.1 Temperature Controller/Servo/Inverter Connection

49.1 Temperature Controller/Servo/Inverter Connection

Digital Indicator

PLC Selection on the Editor	Model	Port	Signal Level	TS Port	Connection	Lst File
F340A	F340A	Option RS-232C interface	RS-232C	COM2	Wiring diagram 1 - COM2	UP_F340A.Lst
F371	F371	Built-in RS-232C interface	RS-232C	COM2	Wiring diagram 2 - COM2	UP_F371.Lst
		Option RS-485 interface	RS-485	COM1	Wiring diagram 1 - COM1	
				COM3	Wiring diagram 1 - COM3	

Load Cell Indicator

PLC Selection on the Editor	Model	Port	Signal Level	TS Port	Connection	Lst File
F800	F800	Option RS-232C interface	RS-232C	COM2	Wiring diagram 1 - COM2	UP_F800.Lst
		Option RS-485 interface	RS-485	COM1	Wiring diagram 1 - COM1	
				COM3	Wiring diagram 1 - COM3	

Weighing Controller

PLC Selection on the Editor	Model	Port	Signal Level	TS Port	Connection	Lst File
F720A	F720A	Built-in RS-232C interface	RS-232C	COM2	Wiring diagram 3 - COM2	UP_F720A.Lst
		Option RS-485 interface	RS-485	COM1	Wiring diagram 1 - COM1	
				COM3	Wiring diagram 1 - COM3	

49.1.1 F340A

Communication Setting

Editor

Communication setting

(Underlined setting: default)

Item	Setting	Remarks
Connection Mode	1 : 1 / <u>1:n</u> / Multi-link2 / Multi-link2 (Ethernet)	
Signal Level	<u>RS-232C</u> / RS-422/485	
Baud Rate	4800 / <u>9600</u> bps	
Data Length	<u>7</u> / 8 bits	
Stop Bit	<u>1</u> / 2 bits	
Parity	None / <u>Odd</u> / Even	
Target Port No.	0 to 31	

Digital Indicator

The communication parameters can be set using keys attached to the digital indicator. Be sure to match the settings to those made on the [Communication Setting] tab window of the editor.

Setting mode 4

(Underlined setting: default)

Parameter	Item	Setting	Setting Example
Mode 4 / RS-232C <input checked="" type="radio"/> HI <input type="radio"/> OK <input type="radio"/> LOW <input checked="" type="radio"/> PEAK <input type="radio"/> HOLD <input checked="" type="radio"/> Blink <input type="radio"/> Off	Communication mode	0: Communication mode 0 *	02000 Communication mode: 0 Baud rate: 9600 bps Character length: 7 bits Parity bit: Odd Stop bit: 1 bit
	Baud rate	2: 4800 bps <u>3: 9600 bps</u>	
	Character length	<u>0: 7 bits</u> 1: 8 bits	
	Parity bit	0: None <u>1: Odd</u> 2: Even	
	Stop bit	<u>0: 1 bit</u> 1: 2 bits	

* When establishing a communication with the TS series, be sure to select "communication mode 0".

Available Memory

The available memory setting range varies depending on the models. Be sure to set within the range available for the device. Use [TYPE] when assigning the indirect memory for macro programs.

Memory	TYPE	Remarks
R (specified value, status read out)	00H	Double-word, read only
W (setting value)	01H	Double-word, W24 and W34: read only

Device: R (Specified Value, Status Read Out)

Address	Name	Remarks									
0	Specified value read out	Read only									
10	Status read out Bit <table border="1" style="display: inline-table; vertical-align: middle;"> <tr> <td>-</td><td>7</td><td>6</td><td>5</td><td>4</td><td>3</td><td>2</td><td>1</td><td>0</td> </tr> </table> LO output signal ———— OK output signal ———— HI output signal ———— Hold Stabilized Close-to-zero output signal	-	7	6	5	4	3	2	1	0	Read only
-	7	6	5	4	3	2	1	0			

Device : W (Setting Value)

Address	Name	Remarks
01	Upper limit	*1
02	Lower limit	*1
03	Comparison between upper limit and lower limit	*1
04	Hysteresis	*1
05	Digital offset	*1
06	Close to zero	*1
11	Digital filter	*1
12	Analog filter	*1
13	MD (stabilized time)	*1
14	MD (stabilized width)	*1
15	Zero tracking (time)	*1
16	Zero tracking (width)	*1
17	Hold mode	*1
18	Automatic print	*1
19	Hold value print	*1
21	LOCK	
22	Minimum scale	*2
23	Display count	*2
24	Applied voltage	Read only
31	BCD data update rate	*1
32	RS-232C	*1
33	D/A zero setting	*1
34	D/A full scale setting	Read only

*1 Writing is prohibited when the setting value is "LOCK". The setting value "LOCK" is specified in "setting mode 3" of F340A.

*2 Writing is prohibited when the calibration value is "LOCK". The calibration value "LOCK" is specified in "setting mode 3" of F340A.

PLC_CTL

Macro command "PLC_CTL F0 F1 F2"

Contents	F0	F1 (= \$u n)		F2
Hold	1 - 8 (PLC1 - 8)	n	Station number	2
		n + 1	Command: 0	
Hold reset	1 - 8 (PLC1 - 8)	n	Station number	2
		n + 1	Command: 1	
Digital zero *1	1 - 8 (PLC1 - 8)	n	Station number	2
		n + 1	Command: 2	
Digital zero reset *1	1 - 8 (PLC1 - 8)	n	Station number	2
		n + 1	Command: 3	
Print command *2	1 - 8 (PLC1 - 8)	n	Station number	2
		n + 1	Command: 4	

*1 Valid only when "1" is set for the calibration value "LOCK". The calibration value "LOCK" is specified in "setting mode 3" of F340A.

*2 Outputs a print command to SIF.

49.1.2 F371

Communication Setting

Editor

Communication setting

(Underlined setting: default)

Item	Setting	Remarks
Connection Mode	1 : 1 / <u>1:n</u> / Multi-link2 / Multi-link2 (Ethernet)	
Signal Level	<u>RS-232C</u> / RS-422/485	
Baud Rate	4800 / <u>9600</u> / 19200 bps	
Data Length	<u>7</u> / 8 bits	
Stop Bit	<u>1</u> / 2 bits	
Parity	<u>None</u> / Odd / Even	
Target Port No.	0 to 31	
CR/LF	CR/LF / <u>CR</u>	

Digital Indicator

The communication parameters can be set using keys attached to the digital indicator.
Be sure to match the settings to those made on the [Communication Setting] tab window of the editor.

Built-in RS-232C Interface

Communication setting

(Underlined setting: default)

Item	Setting	Setting Example
Communication Mode	<u>Communication mode 0</u> *	Communication mode 0
Baud Rate	4800 / <u>9600</u> / 19200 bps	9600 bps
Character Length	7 / <u>8</u> bits	7 bits
Stop Bit	<u>1</u> / 2 bits	1 bit
Parity Bit	<u>None</u> / Odd / Even	None
Terminator	<u>CR</u> / CR + LF	CR

* When establishing a communication with the TS series, be sure to select "communication mode 0".

RS-485 Communication Interface (Option)

Option setting

(Underlined setting: default)

Item	Setting	Setting Example
Communication Mode	<u>Communication mode 0</u> *	Communication mode 0
Baud Rate	4800 / <u>9600</u> / 19200 bps	9600 bps
Character Length	7 / <u>8</u> bits	7 bits
Stop Bit	<u>1</u> / 2 bits	1 bit
Parity Bit	<u>None</u> / Odd / Even	None
Terminator	<u>CR</u> / CR + LF	CR
ID	<u>0000</u> to 9999	0000
Terminating Resistance	With terminating resistance / <u>Without terminating resistance</u>	With terminating resistance
Communication Mode	2-wire / <u>4-wire</u>	2-wire

* When establishing a communication with the TS series, be sure to select "communication mode 0".

Available Memory

The available memory setting range varies depending on the models. Be sure to set within the range available for the device. Use [TYPE] when assigning the indirect memory for macro programs.

Memory	TYPE	Remarks
R (specified value, status read out)	00H	Double-word, read only
W (setting value)	01H	Double-word
RG (waveform data read out)	02H	Double-word, read only

Device: R (Specified Value, Status Read Out)

Address	Name	Remarks									
0	Specified value read out	Read only									
10	Status read out Bit <table border="1" style="display: inline-table; vertical-align: middle;"><tr><td>-</td><td>7</td><td>6</td><td>5</td><td>4</td><td>3</td><td>2</td><td>1</td><td>0</td></tr></table> LO output signal OK output signal HI output signal Hold Stabilized Close-to-zero output signal	-	7	6	5	4	3	2	1	0	Read only
-	7	6	5	4	3	2	1	0			
11	Status read out Bit <table border="1" style="display: inline-table; vertical-align: middle;"><tr><td>-</td><td>7</td><td>6</td><td>5</td><td>4</td><td>3</td><td>2</td><td>1</td><td>0</td></tr></table> LL output signal HH output signal -OVER +LOAD -LOAD +OVER	-	7	6	5	4	3	2	1	0	Read only
-	7	6	5	4	3	2	1	0			

Device : W (Setting Value)

Address	Name	Remarks
11	Higher-higher limit	*1
12	Higher limit	*1
13	Lower limit	*1
14	Lower-lower limit	*1
15	Hysteresis	*1
48	Digital offset setting	*2
16	Close to zero	*1
21	Hold mode	
81	Hold range setting	
22	Hold time	*1
23	Auto start level	*1
24	Minimum count	
25	Local maximum value detection level	
26	Inflection point judgment value	
27	Detection time A	
28	Detection time B	
31	Graph mode	
32	Interval time	
33	Trigger level	*1
34	Level detection mode	*1
1F	Setting CH	
44	Calibration value select	*2
29	Hold point shift amount	

*1 Writing is prohibited when the setting value is "LOCK". The setting value "LOCK" is specified for "motion setting" of F371.

*2 Writing is prohibited when the calibration value is "LOCK". The calibration value "LOCK" is specified for "motion setting" of F371.

Device: RG (Waveform Data Read Out)

Address	Name	Remarks
0	Waveform data 0	Read only
1	Waveform data 1	Read only
:	:	:
199	Waveform data 199	Read only

PLC_CTL

Macro command "PLC_CTL F0 F1 F2"

Contents	F0	F1 (= \$u n)		F2
Digital zero	1 - 8 (PLC1 - 8)	n	Station number	2
		n + 1	Command: 2	
Digital zero reset	1 - 8 (PLC1 - 8)	n	Station number	2
		n + 1	Command: 3	
Print command *1	1 - 8 (PLC1 - 8)	n	Station number	2
		n + 1	Command: 4	
Waveform hold point data read out *2	1 - 8 (PLC1 - 8)	n	Station number	2
		n + 1	Command: 5	
		n + 2	Data No.	
		n + 3 to n + 4	Data	

 Return data: Data stored from controller to TS series

*1 Outputs a print command to SIF.

*2 Return data is given when "HOLD" is set to ON on the hold screen of F371 and "START" is selected on the graph screen.

49.1.3 F800

Communication Setting

Editor

Communication setting

(Underlined setting: default)

Item	Setting	Remarks
Connection Mode	1 : 1 / <u>1:n</u> / Multi-link2 / Multi-link2 (Ethernet)	
Signal Level	<u>RS-232C</u> / RS-422/485	
Baud Rate	4800 / <u>9600</u> / 19200 / 38400 bps	
Data Length	<u>7</u> / 8 bits	
Stop Bit	<u>1</u> / 2 bits	
Parity	None / <u>Odd</u> / Even	
Target Port No.	0 to 31	
CR/LF	<u>CR/LF</u> / CR	

Load Cell Indicator

The communication parameters can be set using keys attached to the load cell indicator. Be sure to match the settings to those made on the [Communication Setting] tab window of the editor.

Setting mode 2

(Underlined setting: default)

Parameter	Item	Setting	Setting Example
RS-232C/485 I/F setting 	Baud rate	2: 4800 bps <u>3: 9600 bps</u> 4: 19200 bps 6: 38400 bps	30101 Baud rate: 9600 bps Character length: 7 bits Parity bit: Odd Stop bit: 1 bit Terminator: CR + LF
	Character length	<u>0: 7 bits</u> 1: 8 bits	
	Parity bit	0: None <u>1: Odd</u> 2: Even	
	Stop bit	<u>0: 1 bit</u> 1: 2 bits	
	Terminator	0: CR <u>1: CR + LF</u>	

Setting mode 3 (only for RS-485 communication)

Parameter	Item	Setting	Setting Example
ID number 	ID *	<u>0000</u> to 9999	0001

* When multiple units of F800 are connected, the ID number must be set to a value other than "0000".

Available Memory

The available memory setting range varies depending on the models. Be sure to set within the range available for the device. Use [TYPE] when assigning the indirect memory for macro programs.

Memory	TYPE	Remarks
R (specified value, status read out)	00H	Double-word, read only
W (setting value)	01H	Double-word

Device: R (Specified Value, Status Read Out)

Address	Name	Remarks
0000	Total weight read out	Read only
0001	Net weight read out	Read only
0002	Tare read out	Read only
0010	Status read out 1 HOLD	Read only
0011	Status read out 1 Zero error	Read only
0012	Status read out 1 Stabilized	Read only
0013	Status read out 1 Taring	Read only
0014	Status read out 1 Total weight display / net weight display	Read only
0015	Status read out 1 LOCK / terminal at rear	Read only
0020	Status read out 2 Bulk supply	Read only
0021	Status read out 2 Medium supply	Read only
0022	Status read out 2 Fine supply	Read only
0023	Status read out 2 Insufficient	Read only
0024	Status read out 2 Correct amount	Read only
0025	Status read out 2 Excessive amount	Read only
0026	Status read out 2 Finish	Read only
0030	Status read out 3 Close to zero	Read only
0031	Status read out 3 Lower limit	Read only
0032	Status read out 3 Upper limit	Read only
0033	Status read out 3 Discharge	Read only
0040	Status read out 4 Weight error	Read only
0041	Status read out 4 Error	Read only
0042	Status read out 4 Operation mode	Read only
0043	Status read out 4 Weight value overflow	Read only
0044	Status read out 4 Calibration error	Read only
0045	Status read out 4 Sequence error	Read only
0050	Cumulative count read out	Read only
0051	Cumulative value read out	Read only

Device : W (Setting Value)

Address	Name	Remarks
00	Code No.	
10	Bulk supply	*1
11	Below the preset amount	*1
12	Preset amount	*1
13	Excessive amount	*1
14	Insufficient	*1
15	Gap	*1
16	Automatic gap control value	*1, *2
17	Offset supply time	*1, *2
20	Timer	*2
21	Comparison prohibit time	*2
22	Upper limit	*2
23	Lower limit	*2
24	Close to zero	
25	Taring setting	
26	AZ count	*2
27	Judgment count	*2
28	Discharge time	*2
29	Weighing start time	
30	Sequence mode	*2

Address	Name	Remarks
31	Weighing function 1	*2
32	Weighing function 2	*2
33	Weighing function 3	*2
34	Function key prohibited	*2
35	Filter	*2
36	Motion detection	*2
37	Zero tracking	*2
40	Weight value	*2
41	Maximum weighing value	*2
42	Minimum scale	*2
43	Net weight excessive	*2
44	Total weight excessive	*2
45	Function select	*2
46	Gravitational acceleration offset	*2
50	Maximum weight	*1, read only
51	Minimum weight	*1, read only
52	Maximum - minimum	*1, read only
53	Average weight	*1, read only
54	Population standard deviation	*1, read only
55	Sample standard deviation	*1, read only

*1 Set for each code.

*2 Writing is prohibited when "LOCK" is set.

"LOCK" can be set by short-circuiting the LOCK terminal on the terminal block at the rear of F800. For more information, refer to the instruction manual of F800.

PLC_CTL

Macro command "PLC_CTL F0 F1 F2"

Contents	F0	F1 (= \$u n)		F2
		n	Station number	
Zero calibration *1	1 - 8 (PLC1 - 8)	n + 1	Command: 0	2
		n + 2	Error result	
		n	Station number	
Span calibration *1	1 - 8 (PLC1 - 8)	n + 1	Command: 1	2
		n + 2	Error result	
		n	Station number	
Switching to total weight display *2	1 - 8 (PLC1 - 8)	n + 1	Command: 2	2
		n	Station number	
Switching to net weight display *2	1 - 8 (PLC1 - 8)	n + 1	Command: 3	2
		n	Station number	
Taring	1 - 8 (PLC1 - 8)	n + 1	Command: 4	2
		n	Station number	
Taring reset	1 - 8 (PLC1 - 8)	n + 1	Command: 5	2
		n	Station number	
Digital zero	1 - 8 (PLC1 - 8)	n + 1	Command: 6	2
		n	Station number	
Digital zero reset	1 - 8 (PLC1 - 8)	n + 1	Command: 7	2
		n	Station number	
Totalize command	1 - 8 (PLC1 - 8)	n + 1	Command: 8	2
		n	Station number	
Cumulative data clear	1 - 8 (PLC1 - 8)	n + 1	Command: 9	2
		n	Station number	
Cumulative data all clear	1 - 8 (PLC1 - 8)	n + 1	Command: 10	2
		n	Station number	
Cumulative data read out	1 - 8 (PLC1 - 8)	n + 1	Command: 11	2
		n + 2	Code No.	
		n + 3 - n + 4	Weighing value	
		n	Station number	
Weighing data read out	1 - 8 (PLC1 - 8)	n + 1	Command: 12	2
		n + 2	Code No.	
		n + 3 - n + 4	Weighing value	
		n	Station number	

Contents	F0	F1 (= \$u n)		F2
Time-out change *3	1 - 8 (PLC1 - 8)	n	Station number	3
		n + 1	Command: 13	
		n + 2	Time-out value (ms)	

Return data: Data stored from controller to TS series

- *1 Calibration is performed based on the value at W40, W41 and W42.
Since a response is given after completion of the calibration on F800, it takes time before the receipt of a response after the calibration command is executed. Before executing the calibration command, execute the time-out change command.
- *2 The display cannot be changed when "1: external input mode" is set for "total weight/net weight display change" of extended function 1 in setting mode 4 of F800.
- *3 Used to change the time-out time of TS to apply when the PLC_CTL command is used. It takes time before a response is sent back after the calibration command is executed. Set a time-out time according to your use environment. The default value is "0", and the time set for [Time-out Time] in the [Communication Setting] tab window in the [Device Connection Setting] dialog is applied.

49.1.4 F720A

Communication Setting

Editor

Communication setting

(Underlined setting: default)

Item	Setting	Remarks
Connection Mode	1 : 1 / <u>1:n</u> / Multi-link2 / Multi-link2 (Ethernet)	
Signal Level	<u>RS-232C</u> / RS-422/485	
Baud Rate	4800 / <u>9600</u> / 19200 / 38400 bps	
Data Length	<u>7</u> / 8 bits	
Stop Bit	<u>1</u> / 2 bits	
Parity	None / <u>Odd</u> / Even	
Target Port No.	0 to 31	
CR/LF	<u>CR/LF</u> / CR	

Weighing Controller

The communication parameters can be set using keys attached to the weighing controller. Be sure to match the settings to those made on the [Communication Setting] tab window of the editor.

Built-in RS-232C Interface

Setting mode 4

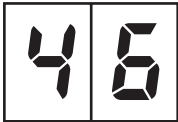

(Underlined setting: default)

Parameter	Item	Setting	Setting Example
RS-232C I/F setting 	Baud rate	2: 4800 bps <u>3: 9600 bps</u> 4: 19200 bps 5: 38400 bps	30101 Baud rate: 9600 bps Character length: 7 bits Parity bit: Odd Stop bit: 1 bit Communication mode: Communication mode 0 (CR + LF)
	Character length	<u>0: 7 bits</u> 1: 8 bits	
	Parity bit	0: None <u>1: Odd</u> 2: Even	
	Stop bit	<u>0: 1 bit</u> 1: 2 bits	
	Communication mode	0: Communication mode 0 (CR) <u>1: Communication mode 0 (CR + LF)</u>	

RS-485 Communication Interface (Option)

Setting mode 4

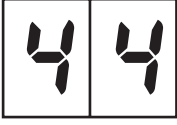
(Underlined setting: default)

Parameter	Item	Setting	Setting Example
RS-485 I/F setting 	Baud rate	2: 4800 bps 3: <u>9600 bps</u> 4: 19200 bps 5: 38400 bps	30101 Baud rate: 9600 bps Character length: 7 bits Parity bit: Odd Stop bit: 1 bit Terminator: CR + LF
	Character length	0: <u>7 bits</u> 1: 8 bits	
	Parity bit	0: None 1: <u>Odd</u> 2: Even	
	Stop bit	0: <u>1 bit</u> 1: 2 bits	
	Terminator	0: CR 1: <u>CR + LF</u>	
ID setting 	ID *	<u>0000</u> to 9999	0001

* When multiple units of F720A are connected, the ID number must be set to a value other than "0000".

Rt switch

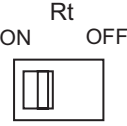
Rt switch	OFF	ON	Remarks
	Terminating resistance OFF	Terminating resistance ON	

Available Memory

The available memory setting range varies depending on the models. Be sure to set within the range available for the device. Use [TYPE] when assigning the indirect memory for macro programs.

Memory	TYPE	Remarks
R (specified value, status read out)	00H	Double-word, read only
W (setting value)	01H	Double-word

Device: R (Specified Value, Status Read Out)

Address	Name	Remarks
0000	Total weight read out	Read only
0001	Net weight read out	Read only
0002	Tare read out	Read only
0010	Status read out 1 Hold	Read only
0011	Status read out 1 Zero error	Read only
0012	Status read out 1 Stabilized	Read only
0013	Status read out 1 Taring	Read only
0014	Status read out 1 Weight display	Read only
0015	Status read out 1 Rear terminal LOCK	Read only
0020	Status read out 2 Bulk supply	Read only
0021	Status read out 2 Medium supply	Read only
0022	Status read out 2 Fine supply	Read only
0023	Status read out 2 Insufficient	Read only
0024	Status read out 2 Correct amount	Read only
0025	Status read out 2 Excessive amount	Read only
0026	Status read out 2 Finish	Read only
0030	Status read out 3 Close to zero	Read only

Address	Name	Remarks
0031	Status read out 3 Lower limit	Read only
0032	Status read out 3 Upper limit	Read only
0040	Status read out 4 Weight error	Read only
0041	Status read out 4 Error	Read only
0042	Status read out 4 Operation mode	Read only
0043	Status read out 4 Weight value overflow	Read only
0044	Status read out 4 Calibration error	Read only
0045	Status read out 4 Sequence error	Read only
0050	Cumulative count read out	Read only
0051	Cumulative value read out	Read only

Device : W (Setting Value)

Address	Name	Remarks
10	Bulk supply	*1
11	Below the preset amount	*1
12	Preset amount	*1
13	Excessive amount	*1
14	Insufficient	*1
15	Gap	*1
16	Automatic gap control value	*2
17	Offset supply time	*2
20	Judgment time	*2
21	Comparison prohibit time	*2
22	Upper limit	*1
23	Lower limit	*1
24	Close to zero	*1
25	Taring setting	*1
26	AZ count	*2
27	Judgment count	*2
28	Completion output time	*2
30	Sequence mode	*2
31	Weighing function 1	*2
32	Weighing function 2	*2
33	Weighing function 3	*2
34	Function key prohibited	*2
35	Analog filter	*2
36	Digital filter	*2
37	Motion detection	*2
38	Zero tracking time	*2
39	Zero tracking width	*2
3A	Setting LOCK	
40	Weight value	*2, *3
41	Maximum weighing value	*2, *3
42	Minimum scale	*2, *3
43	Net weight excessive	*2, *3
44	Total weight excessive	*2, *3
45	Function select	*2
46	Gravitational acceleration offset (area number input)	*2
47	DZ control value	*2, *3
48	Gravitational acceleration offset (acceleration input)	*2
50	Extended function select 1	*2
51	Taring function limitation	*2
52	D/A output mode	*2
53	D/A zero output setting	*2
54	D/A full scale	*2
55	Input select	*2
56	Output select	*2
80	Average weight	Read only
81	Maximum	Read only
82	Minimum	Read only
83	Population standard deviation	Read only

Address	Name	Remarks
84	Sample standard deviation	Read only
85	Maximum - minimum	Read only
86	Cumulative count	Read only
87	Latest cumulative data	Read only

- *1 Writing is prohibited when LOCK1 is ON. "LOCK1" can be set at "setting value LOCK" in setting mode 4 of F720A.
 *2 Writing is prohibited when LOCK2 is ON. "LOCK2" can be set at "setting value LOCK" in setting mode 4 of F720A.
 *3 Writing is prohibited when the LOCK switch is set in the ON position. The LOCK switch is provided at the rear of F720A.

PLC_CTL

Macro command "PLC_CTL F0 F1 F2"

Contents	F0	F1 (= \$u n)		F2
Zero calibration *1	1 - 8 (PLC1 - 8)	n	Station number	2
		n + 1	Command: 0	
		n + 2	Error result	
Span calibration *1	1 - 8 (PLC1 - 8)	n	Station number	2
		n + 1	Command: 1	
		n + 2	Error result	
Switching to total weight display *2	1 - 8 (PLC1 - 8)	n	Station number	2
		n + 1	Command: 2	
Switching to net weight display *2	1 - 8 (PLC1 - 8)	n	Station number	2
		n + 1	Command: 3	
Taring	1 - 8 (PLC1 - 8)	n	Station number	2
		n + 1	Command: 4	
Taring reset	1 - 8 (PLC1 - 8)	n	Station number	2
		n + 1	Command: 5	
Digital zero	1 - 8 (PLC1 - 8)	n	Station number	2
		n + 1	Command: 6	
Digital zero reset	1 - 8 (PLC1 - 8)	n	Station number	2
		n + 1	Command: 7	
Totalize command	1 - 8 (PLC1 - 8)	n	Station number	2
		n + 1	Command: 8	
Cumulative data clear	1 - 8 (PLC1 - 8)	n	Station number	2
		n + 1	Command: 9	
Cumulative data read out	1 - 8 (PLC1 - 8)	n	Station number	2
		n + 1	Command: 11	
		n + 2	Fixed value 00	
Time-out change *3	1 - 8 (PLC1 - 8)	n + 3 - n + 4	Weighing value	3
		n	Station number	
		n + 1	Command: 13	
		n + 2	Time-out value (ms)	

Return data: Data stored from controller to TS series

- *1 Calibration is performed based on the value at W40, W41 and W42. Since a response is given after completion of the calibration on F720A, it takes time before the receipt of a response after the calibration command is executed. Before executing the calibration command, execute the time-out change command.
 *2 The display cannot be changed when "1: external input mode" is set for "total weight/net weight display change" of extended function 1 in setting mode 4 of F720A.
 *3 Used to change the time-out time of TS to apply when the PLC_CTL command is used. It takes time before a response is sent back after the calibration command is executed. Set a time-out time according to your use environment. The default value is "0", and the value varies according to the time set for [Time-out Time] in the [Communication Setting] tab window in the [Device Connection Setting] dialog.

49.1.5 Wiring Diagrams

When Connected at COM1:

RS-422

Wiring diagram 1 - COM1

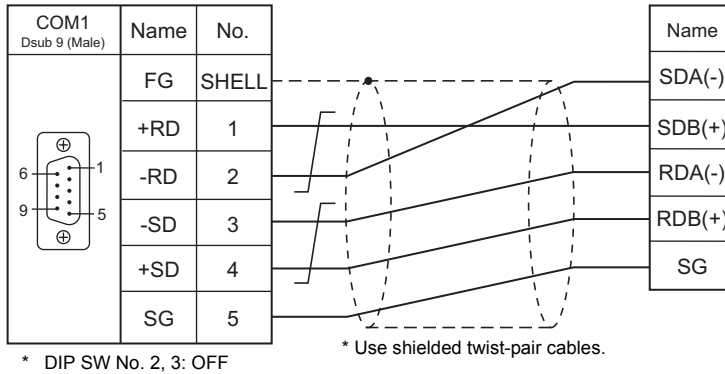

When Connected at COM2:

RS-232C

Wiring diagram 1 - COM2

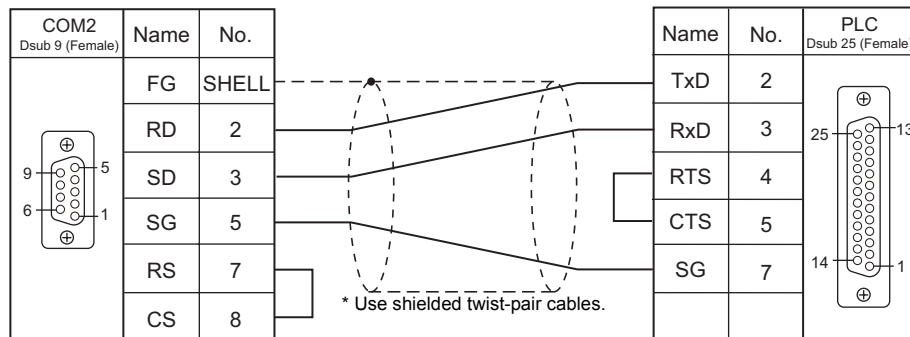

Wiring diagram 2 - COM2

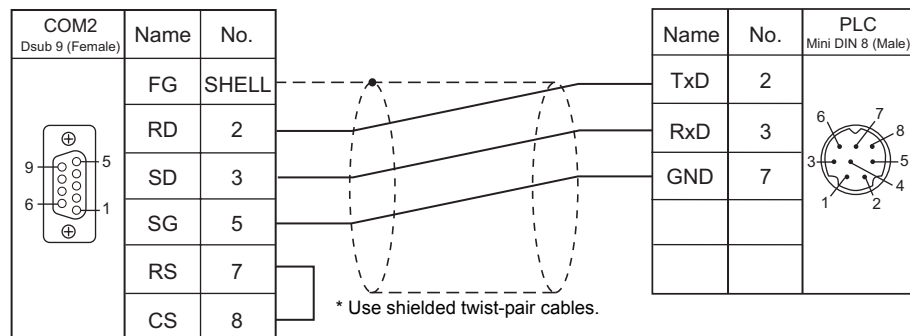

Wiring diagram 3 - COM2

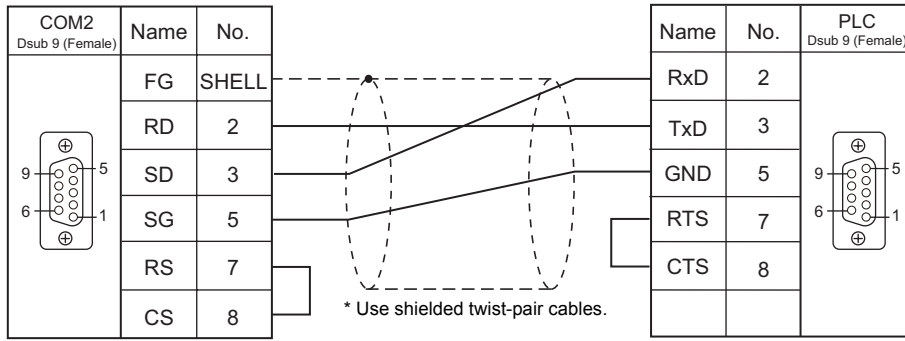

When Connected at COM3:

RS-485

Wiring diagram 1 - COM3

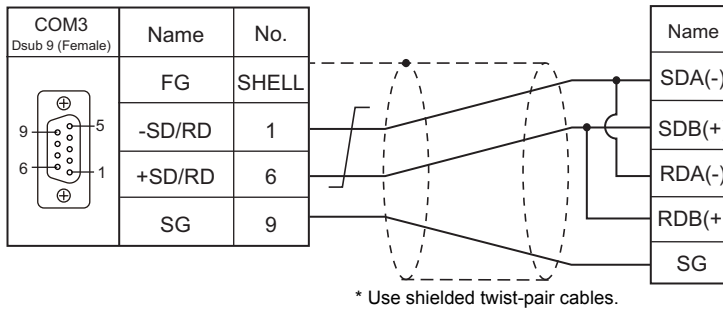

50. UNITRONICS

50.1 PLC Connection

50.1 PLC Connection

Serial Connection

PLC Selection on the Editor	PLC	Port	Signal Level	TS Port	Connection	Ladder Transfer *1
M90/M91/Vision Series (ASCII)	M90	COM1	RS-232C	COM2	Wiring diagram 1 - COM2	×
	M91 V130 V350-35-R2	COM1	RS-232C	COM2	Wiring diagram 1 - COM2	
			RS-485	COM1	Wiring diagram 1 - COM1	
				COM3	Wiring diagram 1 - COM3	
	V230 V260 V280 V290 V530	COM1	RS-232C	COM2	Wiring diagram 1 - COM2	
		COM2	RS-232C	COM2	Wiring diagram 1 - COM2	
			RS-485	COM1	Wiring diagram 1 - COM1	
				COM3	Wiring diagram 1 - COM3	
	V120 V290-19-C30BT/40BT V560 V570 V1040 V1210	COM1/COM2	RS-232C	COM2	Wiring diagram 1 - COM2	
			RS-485	COM1	Wiring diagram 1 - COM1	
COM3				Wiring diagram 1 - COM3		

*1 For the ladder transfer function, see "Appendix 5 Ladder Transfer Function".

Ethernet Connection

PLC Selection on the Editor	Model	Unit	TCP/IP	UDP/IP	Port No.
Vision Series (ASCII Ethernet TCP/IP)	V230 V260 V280 V290 V530 V560 V570 V1040 V1210	V200-19-ET1	○	×	0 to 65535 (Default: 20256) (Max. 4 units)
	V130 V350	V100-17-ET2			
	V1040 V1210	Built-in Ethernet port			

50.1.1 M90/M91/Vision Series (ASCII)

Communication Setting

Editor

Communication setting

(Underlined setting: default)

Item	Setting	Remarks
Connection Mode	<u>1:1</u> / Multi-link2	
Signal Level	<u>RS-232C</u> / RS-422/485	
Baud Rate	4800 / 9600 / 19200 / 38400 / <u>57600</u> / 115K bps	
Data Length	7 / <u>8</u> bits	
Stop Bit	<u>1</u> / 2 bits	
Parity	<u>None</u> / Odd / Even	
Target Port No.	0 to 31	Specify "0" for RS-422/485 communication. On the PLC side, specify a number from "64" to "127".

PLC

Parameter

Parameters must be set in Information Mode or by creating a ladder program using the software "VisiLogic". For more information, refer to the instruction manual issued by UNITRONICS.

When using RS-485 communication, be sure to create the ladder program.

M91

RS232/RS485 Jumper Setting

(Underlined setting: default)

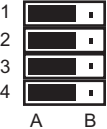
Jumper Setting	Item	Setting	Remarks									
	No. 1 No. 2	<table border="1"> <thead> <tr> <th></th> <th>No. 1</th> <th>No. 2</th> </tr> </thead> <tbody> <tr> <td><u>RS232</u></td> <td>A</td> <td>A</td> </tr> <tr> <td>RS485</td> <td>B</td> <td>B</td> </tr> </tbody> </table>		No. 1	No. 2	<u>RS232</u>	A	A	RS485	B	B	
		No. 1	No. 2									
<u>RS232</u>	A	A										
RS485	B	B										
No. 3 No. 4	<table border="1"> <thead> <tr> <th></th> <th>No. 3</th> <th>No. 4</th> </tr> </thead> <tbody> <tr> <td><u>Provided</u></td> <td>A</td> <td>A</td> </tr> <tr> <td>Not provided</td> <td>B</td> <td>B</td> </tr> </tbody> </table>		No. 3	No. 4	<u>Provided</u>	A	A	Not provided	B	B		
	No. 3	No. 4										
<u>Provided</u>	A	A										
Not provided	B	B										

V130 / V350-35-R2

RS232 to RS485 Jumper Setting

(Underlined setting: default)

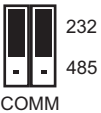
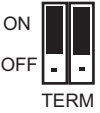
Jumper Setting	Item	Setting	Remarks									
	COMM	<table border="1"> <thead> <tr> <th></th> <th>232</th> <th>232</th> </tr> </thead> <tbody> <tr> <td><u>RS232</u></td> <td>232</td> <td>232</td> </tr> <tr> <td>RS485</td> <td>485</td> <td>485</td> </tr> </tbody> </table>		232	232	<u>RS232</u>	232	232	RS485	485	485	
	232	232										
<u>RS232</u>	232	232										
RS485	485	485										
	TERM	<table border="1"> <thead> <tr> <th></th> <th>ON</th> <th>ON</th> </tr> </thead> <tbody> <tr> <td><u>Provided</u></td> <td>ON</td> <td>ON</td> </tr> <tr> <td>Not provided</td> <td>OFF</td> <td>OFF</td> </tr> </tbody> </table>		ON	ON	<u>Provided</u>	ON	ON	Not provided	OFF	OFF	
	ON	ON										
<u>Provided</u>	ON	ON										
Not provided	OFF	OFF										





V230 / V260 / V280 / V290 / V530**RS232/RS485 Jumper Setting**

(Underlined setting: default)

Jumper Setting		Item	Setting				Remarks	
	No. 1 No. 2 No. 3 No. 4	Signal level/ RS485 terminating resistance		No. 1	No. 2	No. 3	No. 4	
			<u>RS232</u>	A	A	A	A	
			RS485	B	B	B	B	
			RS485 With resistance	A	A	B	B	

V120**RS232/RS485 Jumper Setting**

(Underlined setting: default)

Jumper Setting		Item	Setting		Remarks	
	No. 1 No. 2	Signal level (COM1)		No. 1	No. 2	
			<u>RS232</u>	A	A	
	No. 3 No. 4	RS485 terminating resistance (COM1)		No. 3	No. 4	
			<u>Provided</u>	A	A	
	No. 5 No. 6	Signal level (COM2)		No. 5	No. 6	
			<u>RS232</u>	A	A	
	No. 7 No. 8	RS485 terminating resistance (COM2)		No. 7	No. 8	
			<u>Provided</u>	A	A	
				No. 7	No. 8	
			Not provided	B	B	

V290-19-C30B/V290-19-T40B/V560/V570/V1040/V1210**RS232/RS485 DIP Switch Settings**

(Underlined setting: default)

Dip SW	Item	Setting						Remarks	
	Signal level RS485 terminating resistance		No. 1	No. 2	No. 3	No. 4	No. 5	No. 6	These settings are common to both COM1 and COM2.
		<u>RS232</u>	ON	ON	ON	OFF	ON	OFF	
		RS485	OFF	OFF	OFF	ON	OFF	ON	
		RS485 With resistance	ON	ON	OFF	ON	OFF	ON	

VisiLogic

(Underlined setting: default)

Item		Setting	Remarks
Direct Contact		<u>SB: 2</u>	For more information, refer to the VisiLogic instruction manual.
Set PLC Name		Specify a desired name.	
Com Init	Com Port	COM1 / COM2	
	Data Bits	7 / 8	
	Standard	RS232 / RS485	
	Baud Rate	4800 / 9600 / 19200 / 38400 / 54600 / 115200 bps	
	Parity	NONE / EVEN / ODD	
Stop Bits		1 / 2	

Direct Contact

Specify "2" for the SB address and register it into the ladder program.

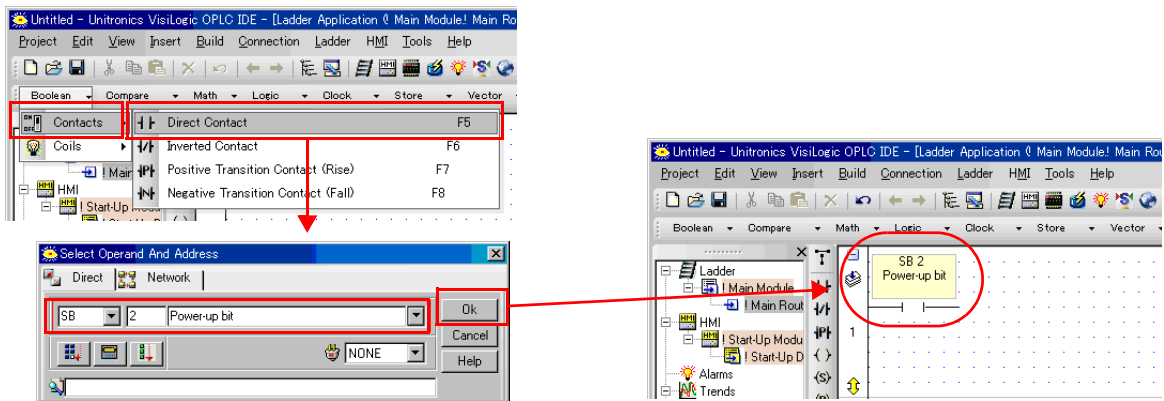

Set PLC Name

Specify a desired PLC name.

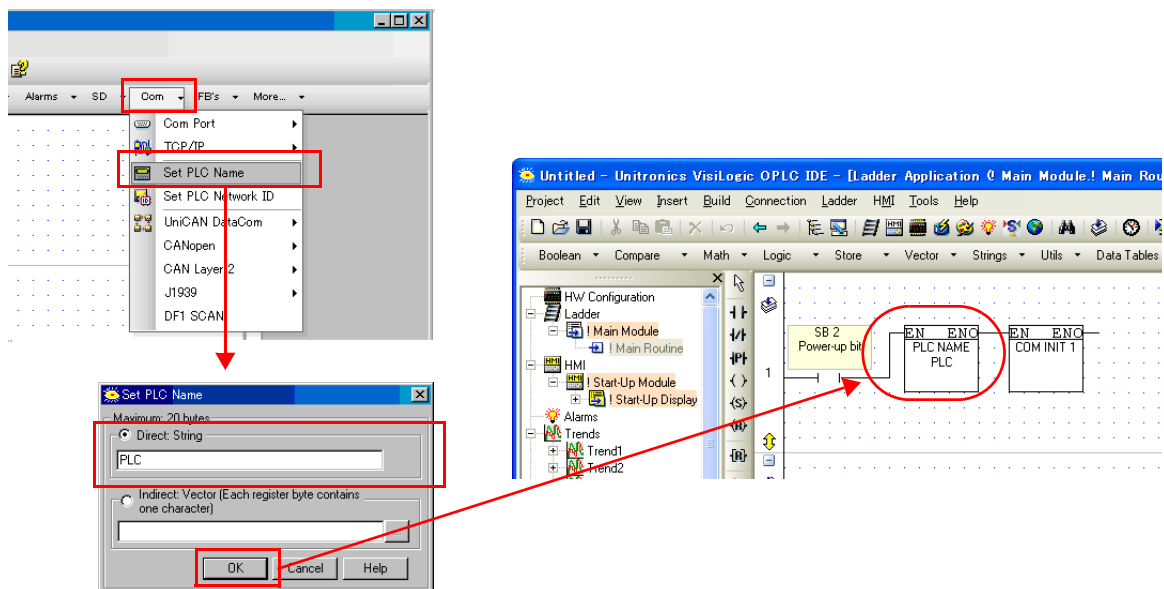

Com Init

Make settings for [COM Port], [Data Bits], [Standard], [Baud Rate], [Parity] and [Stop Bits].

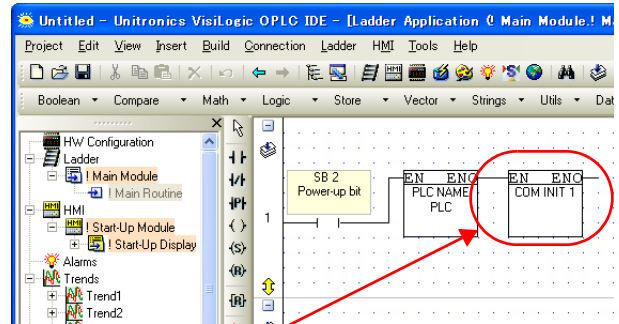
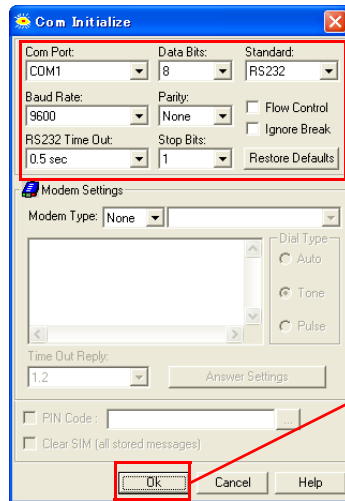
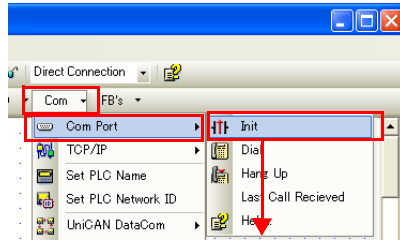

Available Memory

The available memory setting range varies depending on the PLC model. Be sure to set within the range available for the PLC. Use [TYPE] when assigning the indirect memory for macro programs.

Memory	TYPE	Remarks
MB (Memory bit)	00H	
MI (Memory int)	01H	
ML (Memory long)	02H	Double-word
MD (Memory double)	03H	Double-word
MF (Memory float)	04H	Real number. Bit designation is not possible.
SB (System bit)	05H	
SI (System int)	06H	
SL (System long)	07H	Double-word
SD (System double)	08H	Double-word
INP (Input)	09H	Read only
OUT (Output)	0AH	
TS (Timer scan bit)	0BH	Read only
TP (Timer preset)	0CH	Double-word, read only
TC (Timer current)	0DH	Double-word, read only
CS (Counter scan bit)	0EH	Read only
CP (Counter preset)	0FH	Read only
CC (Counter current)	10H	Read only

Indirect Memory Designation

	15	8	7	0
n + 0	Model		Memory type	
n + 1	Address No.			
n + 2	Expansion code *		Bit designation	
n + 3	00		Station number	

* In the expansion code, set which word, higher or lower, is to be read when a double-word address is specified (expansion bit designation).

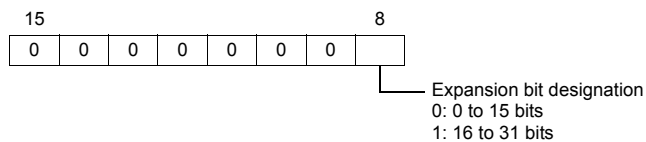

PLC_CTL

Macro command "PLC_CTL F0 F1 F2"

Contents	F0	F1 (= \$u n)		F2
PLC operation status setting	1 - 8 (PLC1 - 8)	n	Station number	3
		n + 1	Command: 0000H	
		n + 2	PLC status 0: Run 1: Stop 2: Memory init and reset 3: Reset 4: Switch to BootStrap *1	
Sending key data from remote unit *2	1 - 8 (PLC1 - 8)	n	Station number	3
		n + 1	Command: 0001H	
		n + 2	Key data	
Unit ID read out	1 - 8 (PLC1 - 8)	n	Station number	2
		n + 1	Command: 0002H	
		n + 2	Unit ID	
Unit ID setting	1 - 8 (PLC1 - 8)	n	Station number	3
		n + 1	Command: 0003H	
		n + 2	Unit ID	
Version acquisition	1 - 8 (PLC1 - 8)	n	Station number	2
		n + 1	Command: 0004H	
		n + 2 to n + 29	Version, model type (CHAR data)	

 Return data: Data stored from the PLC to the TS series

*1 After the setting is made, the PLC must be shut off and restarted.

*2 This command is used when a password is entered into the PLC from the TS series. Since the password consists of four digits, the command must be executed four times.

Detail of the key data:

40 to 49: "0" to "9"

50.1.2 Vision Series (ASCII Ethernet TCP/IP)

Communication Setting

Editor

Make the following settings on the editor. For more information, see Appendix 2 Ethernet.

- IP address for the TS unit
 - When specified on the screen data:
[System Setting] → [Ethernet Communication] → [Local Port IP Address]
 - When specified on the TS unit:
Main Menu screen → [Ethernet]
- Port number for the TS unit (for communication with PLC)
[System Setting] → [Device Connection Setting] → [Communication Setting]

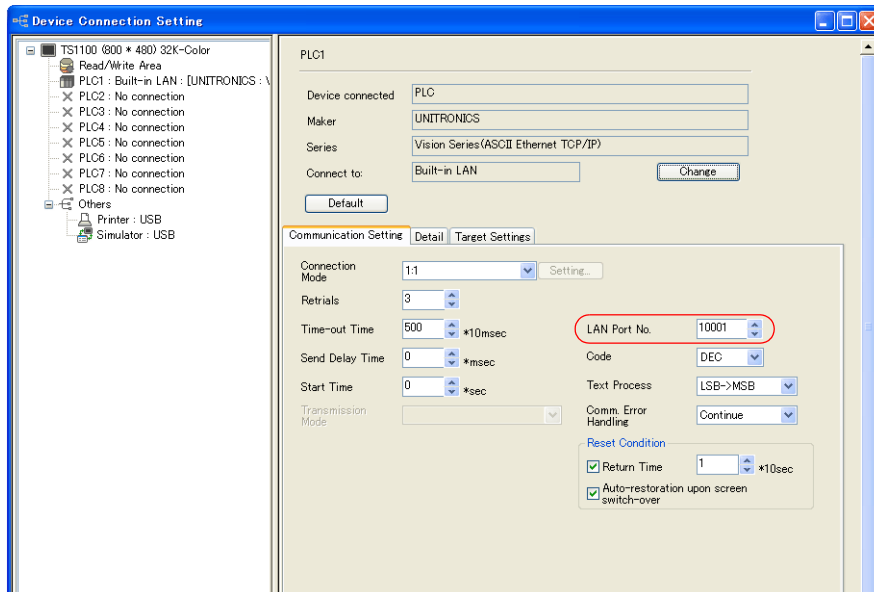

- IP address and port number of the PLC
[System Setting] → [Device Connection Setting] → [PLC Table]

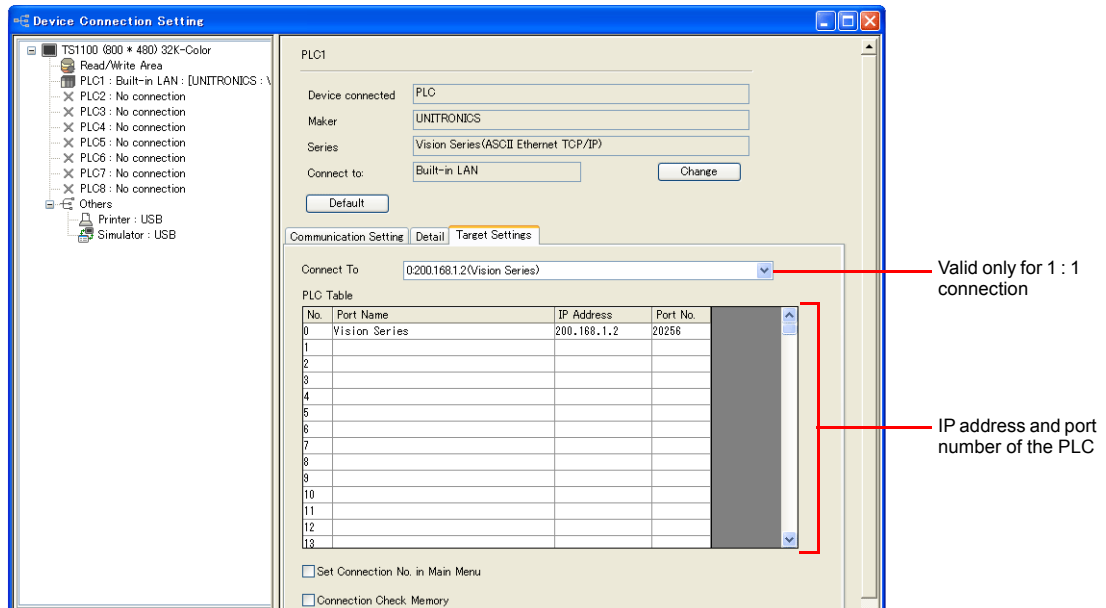

PLC

Parameter

Parameters must be set in Information Mode or by creating a ladder program using the software “VisiLogic”. For more information, refer to the instruction manual issued by UNITORONICS.

VisiLogic

Item	Setting	Remarks
Direct Contact	SB: 2	
Set PLC Name	Specify a desired name.	
Com Init	IP Address	IP address of the Vision Series
	Subnet Mask	Specify according to the environment.
	Default Gateway	Specify according to the environment.
Socket Init	Socket	Socket1
	Protocol	TCP
	Local Port	0 to 65535 (default: 20256)
	Master/Slave	Slave

For more information, refer to the VigiLogic instruction manual.

Direct Contact

Specify “2” for the SB address and register it into the ladder program.

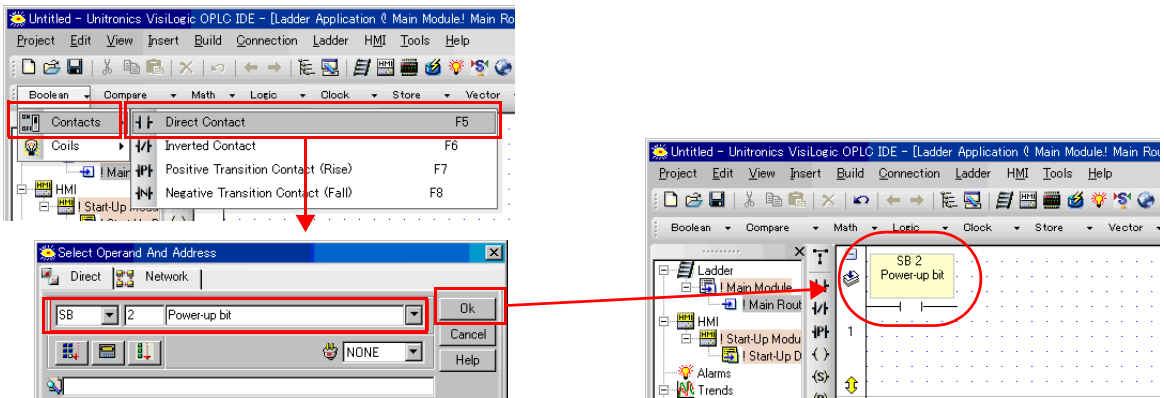

Set PLC Name

Specify a desired PLC name.

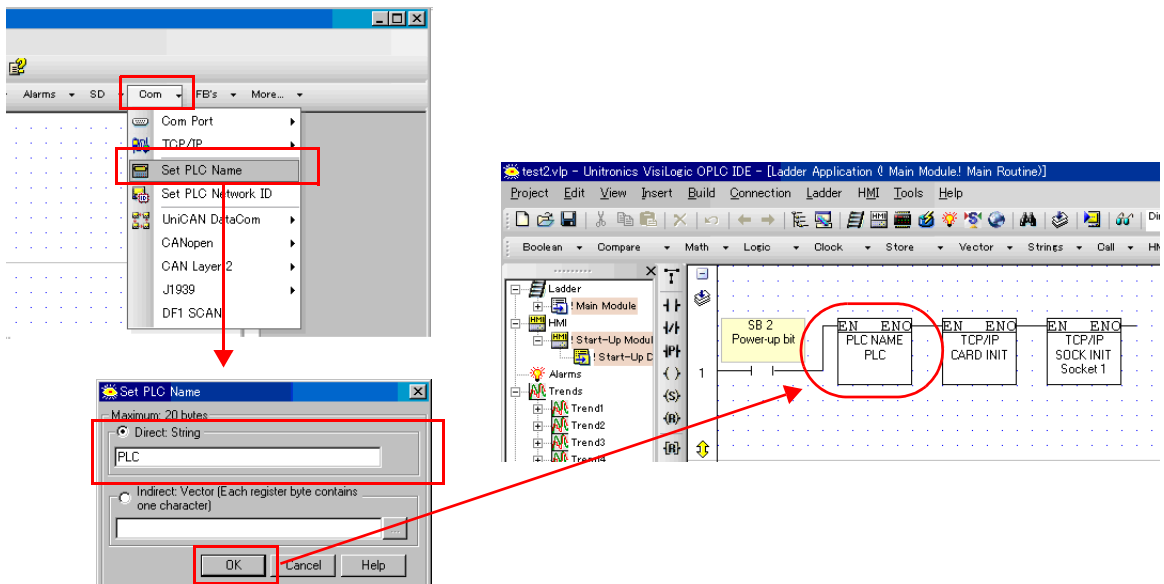

Com Init

Specify the IP address, subnet mask and default gateway.

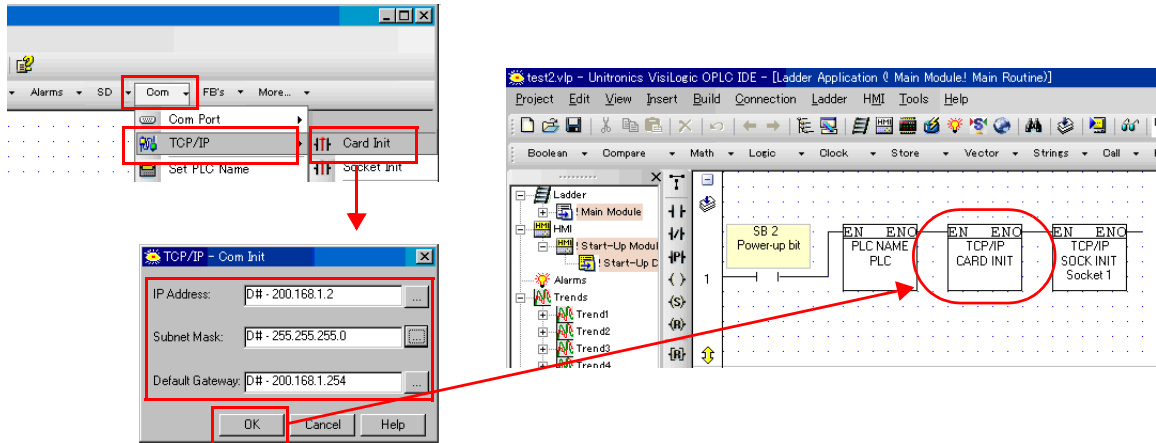

Socket Init

Make settings for [Socket], [Protocol], [Local Port], and [Master/Slave].

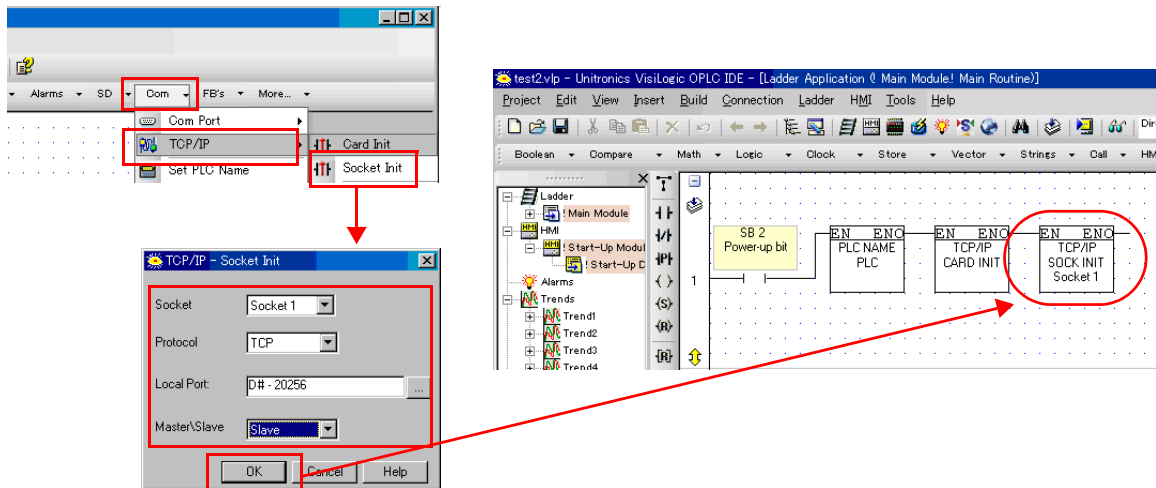

Available Memory

The available memory setting range varies depending on the PLC model. Be sure to set within the range available for the PLC. Use [TYPE] when assigning the indirect memory for macro programs.

Memory	TYPE	Remarks
MB (Memory bit)	00H	
MI (Memory int)	01H	
ML (Memory long)	02H	Double-word
MD (Memory double)	03H	Double-word
MF (Memory float)	04H	Real number. Bit designation is not possible.
SB (System bit)	05H	
SI (System int)	06H	
SL (System long)	07H	Double-word
SD (System double)	08H	Double-word
INP (Input)	09H	Read only
OUT (Output)	0AH	
TS (Timer scan bit)	0BH	Read only
TP (Timer preset)	0CH	Double-word, read only
TC (Timer current)	0DH	Double-word, read only
CS (Counter scan bit)	0EH	Read only
CP (Counter preset)	0FH	Read only
CC (Counter current)	10H	Read only

Indirect Memory Designation

	15	8	7	0
n + 0	Model		Memory type	
n + 1	Address No.			
n + 2	Expansion code *		Bit designation	
n + 3	00		Station number	

* In the expansion code, set which word, higher or lower, is to be read when a double-word address is specified (expansion bit designation).

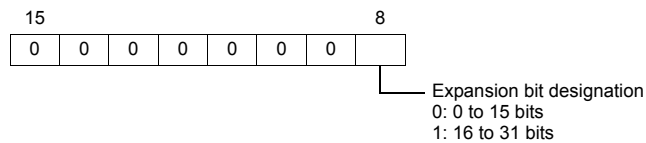

PLC_CTL

Macro command "PLC_CTL F0 F1 F2"

Contents	F0	F1 (= \$u n)		F2
PLC operation status setting	1 - 8 (PLC1 - 8)	n	Station number	3
		n + 1	Command: 0000H	
		n + 2	PLC status 0: Run 1: Stop 2: Memory init and reset 3: Reset 4: Switch to BootStrap *1	
Sending key data from remote unit *2	1 - 8 (PLC1 - 8)	n	Station number	3
		n + 1	Command: 0001H	
		n + 2	Key data	
Unit ID read out	1 - 8 (PLC1 - 8)	n	Station number	2
		n + 1	Command: 0002H	
		n + 2	Unit ID	
Unit ID setting	1 - 8 (PLC1 - 8)	n	Station number	3
		n + 1	Command: 0003H	
		n + 2	Unit ID	
Version data acquisition	1 - 8 (PLC1 - 8)	n	Station number	2
		n + 1	Command: 0004H	
		n + 2 to n + 29	Version, model type (CHAR data)	

Return data: Data stored from the PLC to the TS series

*1 After the setting is made, the PLC must be shut off and restarted.

*2 This command is used when a password is entered into the PLC from the TS series. Since the password consists of four digits, the command must be executed four times.

Detail of the key data:

40 to 49: "0" to "9"

50.1.3 Wiring Diagrams

When Connected at COM1:

RS-485

Wiring diagram 1 - COM1

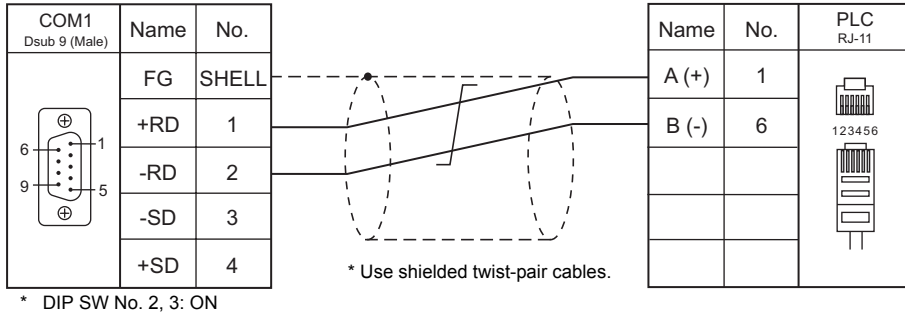

When Connected at COM2:

RS-232C

Wiring diagram 1 - COM2

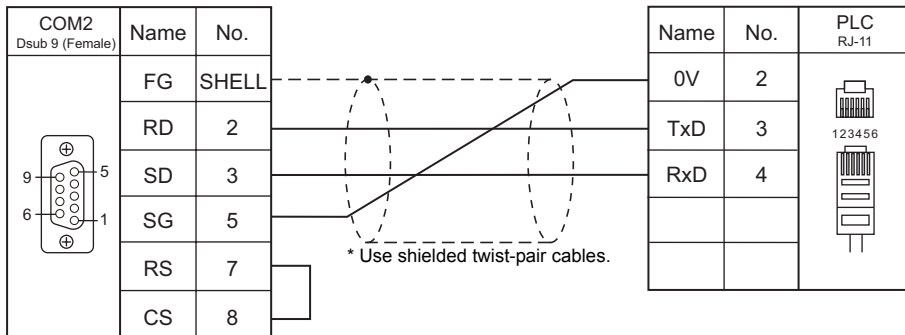

When Connected at COM3:

RS-485

Wiring diagram 1 - COM3

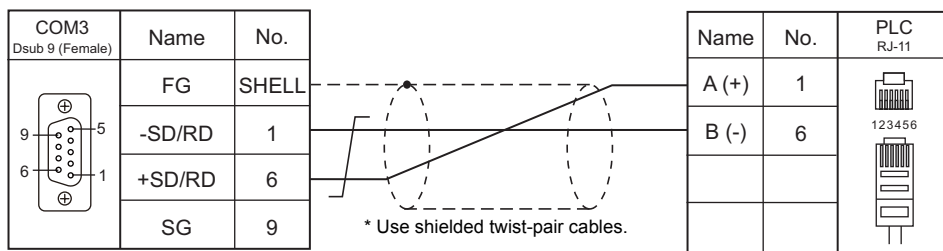

51. VIGOR

51.1 PLC Connection

51.1 PLC Connection

Serial Connection

PLC Selection on the Editor	CPU	Unit/Port		Signal Level	TS Port	Connection	Ladder Transfer *1
M series	M1-CPU1	COM PORT	M-232R	RS-232C	COM2	Wiring diagram 1 - COM2	×
			M-485R	RS-422	COM1	Wiring diagram 1 - COM1	
				RS-485	COM3	Wiring diagram 1 - COM3	

*1 For the ladder transfer function, see "Appendix 5 Ladder Transfer Function".

51.1.1 M Series

Communication Setting

Editor

Communication setting

(Underlined setting: default)

Item	Setting	Remarks
Connection Mode	<u>1 : 1</u> / 1 : n / Multi-link2 / Multi-link2 (Ethernet) / 1 : n Multi-link2 (Ethernet)	
Signal Level	<u>RS-232C</u> / RS-422/485	
Baud Rate	4800 / 9600 / <u>19200</u> / 38400bps	
Data Length	7 bits	
Stop Bit	1 bit	
Parity	Even	
Target Port No.	<u>0</u> to 255	

PLC

Make PLC settings using the application software "Ladder Master". For more information, refer to the PLC manual issued by the manufacturer.

M-232R / M-485R

(Underlined setting: default)

Item	Setting	Remarks
Application	Computer Link	
Computer Link Detail	Station Number	0 to 255
	Baud Rate	4800 / 9600 / <u>19200</u> / 38400bps

38400 bps supported by M-485R only

Available Memory

The available memory setting range varies depending on the PLC model. Be sure to set within the range available for the PLC. Use [TYPE] when assigning the indirect memory for macro programs.

Memory	TYPE	Remarks
D (Data register / Special register)	00H	D0 to D8191, D9000 to D9255
X (Input relay)	01H	
Y (Output relay)	02H	
M (Internal relay / Special relay)	03H	M0 to M5119, M9000 to M9255
S (Internal relay / Step relay)	04H	
T (Timer / Current value)	05H	
C (Counter / Current value)	06H	
32C (High-speed counter / Current value)	07H	Double-word
TS (Timer / Contact)	08H	
CS (Counter / Contact)	09H	
TC (Timer / Coil)	0AH	
CC (Counter / Coil)	0BH	

51.1.2 Wiring Diagrams

When Connected at COM1:

RS-422

Wiring diagram 1 - COM1

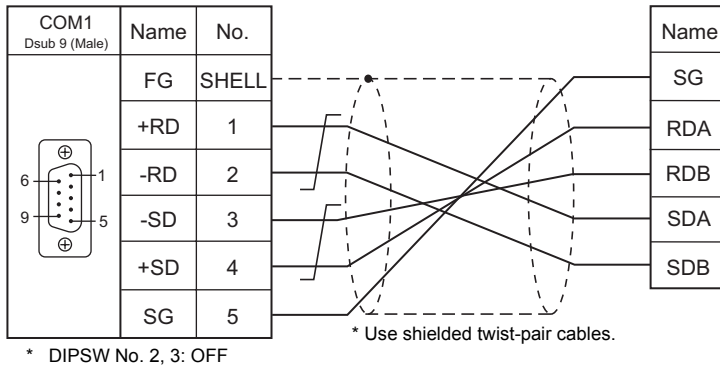

When Connected at COM2:

RS-232C

Wiring diagram 1 - COM2

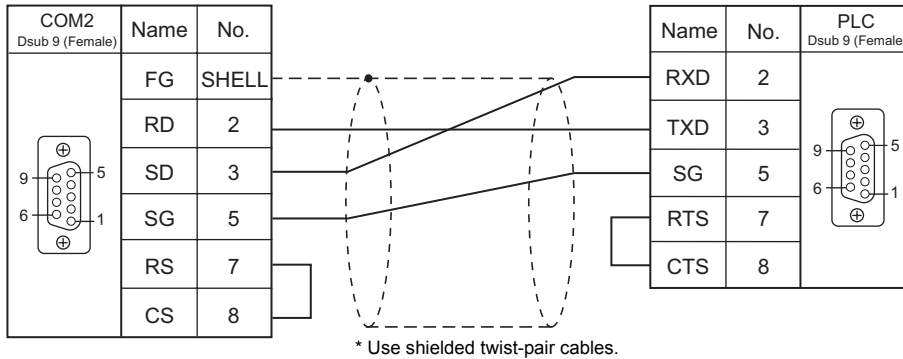

When Connected at COM3:

RS-485

Wiring diagram 1 - COM3

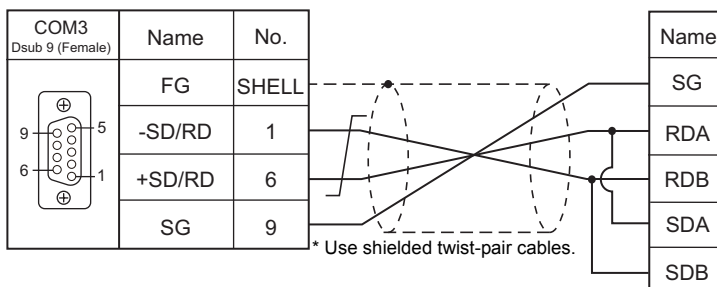

MEMO

Please use this page freely.

52. WAGO

52.1 PLC Connection

52.1 PLC Connection

Serial Connection

PLC Selection on the Editor	CPU	Unit/Port	Signal Level	TS Port	Connection	Ladder Transfer ^{*1}
750 series (MODBUS RTU)	750-314 750-316 750-814 750-816 750-873	Fieldbus connector	RS-232C	COM2	Wiring diagram 1 - COM2	×
	COM1			Wiring diagram 1 - COM1		
	750-312 750-315 750-812 750-815		RS-422	COM3	Wiring diagram 1 - COM3	

*1 For the ladder transfer function, see "Appendix 5 Ladder Transfer Function".

Ethernet Connection

PLC Selection on the Editor	CPU	Unit	TCP/IP	UDP/IP	Port No.	Ladder Transfer ^{*1}
750 series (MODBUS Ethernet)	750-341 750-342 750-841 750-842 750-871 750-873	CPU with built-in Ethernet	○	○	502 (fixed) ^{*2}	×

*1 For the ladder transfer function, see "Appendix 5 Ladder Transfer Function".

*2 A maximum of 15 units including the ladder tool can be connected.

52.1.1 750 Series (MODBUS RTU)

Communication Setting

Editor

Communication setting



(Underlined setting: default)

Item	Setting	Remarks
Connection Mode	1 : 1 / <u>1:n</u> / Multi-link2 / Multi-link2 (Ethernet) / 1 : n Multi-link2 (Ethernet)	
Signal Level	<u>RS-232C</u> / RS-422/485	
Baud Rate	4800 / <u>9600</u> / 19200 / 38400 / 57600 / 115K bps	Up to 19200 bps is available on 750-312, 750-314, 750-812 and 750-814. 4800 and 38400 bps are not available on 750-873.
Data Length	8 bits	
Stop Bit	<u>1</u> / 2 bits	
Parity	<u>None</u> / Odd / Even	
Target Port No.	0 to 255	Select station No. 0 for a broadcast command.

Bus Coupler / Bus Controller

750-312 / 750-314 / 750-315 / 750-316

Node address rotary switch

Address	Contents	Setting Example
 	1 to 99	1

DIP switch FR

(Underlined setting: default)

DIP Switch FR	Contents						Setting Example																												
FR1 FR2 FR3	<table border="1"> <thead> <tr> <th>Baud Rate</th> <th>FR1</th> <th>FR2</th> <th>FR3</th> </tr> </thead> <tbody> <tr> <td>4800 bps</td> <td>ON</td> <td>OFF</td> <td>ON</td> </tr> <tr> <td><u>9600 bps</u></td> <td><u>OFF</u></td> <td><u>ON</u></td> <td><u>ON</u></td> </tr> <tr> <td>19200 bps</td> <td>ON</td> <td>ON</td> <td>ON</td> </tr> <tr> <td>38400 bps*</td> <td>OFF</td> <td>OFF</td> <td>OFF</td> </tr> <tr> <td>57600 bps*</td> <td>ON</td> <td>OFF</td> <td>OFF</td> </tr> <tr> <td>115 kbps*</td> <td>OFF</td> <td>ON</td> <td>OFF</td> </tr> </tbody> </table>						Baud Rate	FR1	FR2	FR3	4800 bps	ON	OFF	ON	<u>9600 bps</u>	<u>OFF</u>	<u>ON</u>	<u>ON</u>	19200 bps	ON	ON	ON	38400 bps*	OFF	OFF	OFF	57600 bps*	ON	OFF	OFF	115 kbps*	OFF	ON	OFF	
	Baud Rate	FR1	FR2	FR3																															
	4800 bps	ON	OFF	ON																															
	<u>9600 bps</u>	<u>OFF</u>	<u>ON</u>	<u>ON</u>																															
	19200 bps	ON	ON	ON																															
	38400 bps*	OFF	OFF	OFF																															
57600 bps*	ON	OFF	OFF																																
115 kbps*	OFF	ON	OFF																																
* Available only on 750-315 and 750-316.																																			
FR4 FR5 FR6	Parity	Data Length	Stop Bit	FR4	FR5	FR6																													
	<u>None</u>	<u>8 bits</u>	<u>1 bit</u>	<u>OFF</u>	<u>OFF</u>	<u>OFF</u>																													
	Even			ON	OFF	OFF																													
	Odd			OFF	ON	OFF																													
None		2 bits	ON	ON	OFF																														
Baud rate: 9600 bps Parity: None Data length: 8 bits Stop bit: 1 bit																																			

* Before making settings on the DIP switch FR, be sure to turn off the power to the bus coupler.

DIP switch P

(Underlined setting: default)

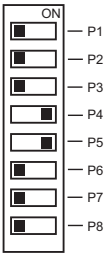
DIP Switch P	Contents	OFF	ON			Setting Example
P1 P2 P3	End of communication frame data	End of Data	P1	P2	P3	
		<u>Three frames</u>	<u>QFE</u>	<u>QFE</u>	<u>QFE</u>	
		100 msec	ON	OFF	OFF	
		200 msec	OFF	ON	OFF	
		500 msec	ON	ON	OFF	
		1 sec.	OFF	OFF	ON	
		1 msec	ON	OFF	ON	
		10 msec	OFF	ON	ON	
50 msec	ON	ON	ON			
P4	Data transfer mode	ASCII mode	<u>RTU mode</u>			
P5	Error check code	Ignored	<u>Executed</u>			
P6	Others	<u>OFF</u>				
P7						
P8						

* Before making settings on the DIP switch P, be sure to turn off the power to the bus coupler.

Terminating resistance



Make settings only when 750-312 or 750-315 is used.

- For 2-wire system
- For 4-wire system



750-812 / 750-814 / 750-815 / 750-816

Node address rotary switch

Address	Contents	Setting Example
x1  x10 	1 to 99	1

PLC-PRG (PRG-FBD)

Set communication parameters using the ladder tool “WAGO-I/O-PRO 32” or “WAGO-I/O-PRO CAA”. For more information, refer to the PLC manual issued by the manufacturer.

- * When setting the communication parameters, set the node address rotary switch to “0” and the operation mode switch in the upper (“run”) or center (“stop”) position.

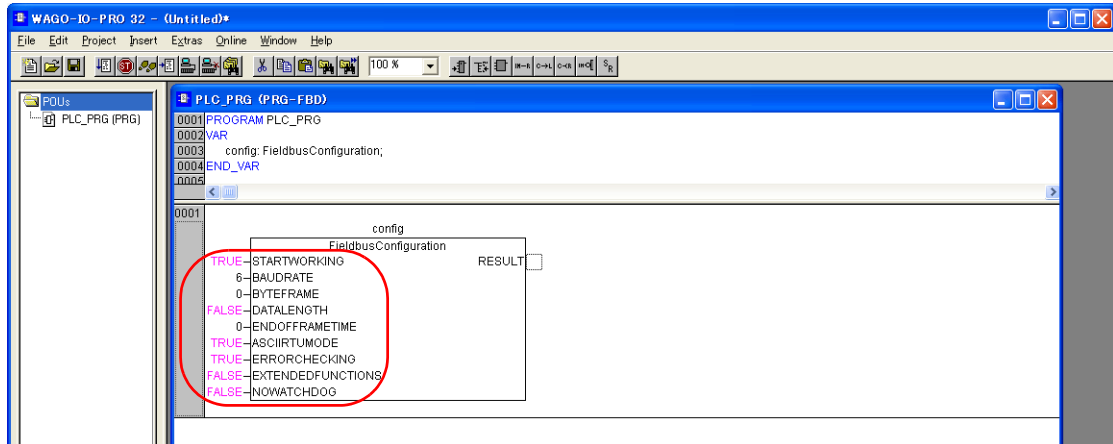

(Underlined setting: default)

Setting Items	Contents	Setting Example																		
STARTWORKING	TRUE	TRUE																		
BAUDRATE	<table border="1"> <thead> <tr> <th>Baud rate</th> <th>Value</th> </tr> </thead> <tbody> <tr> <td>4800 bps</td> <td>5</td> </tr> <tr> <td><u>9600 bps</u></td> <td><u>6</u></td> </tr> <tr> <td>19200 bps</td> <td>7</td> </tr> <tr> <td>38400 bps</td> <td>0*</td> </tr> <tr> <td>57600 bps</td> <td>1*</td> </tr> <tr> <td>115 kbps</td> <td>2*</td> </tr> </tbody> </table> <p>* Available only on 750-815 and 750-816.</p>	Baud rate	Value	4800 bps	5	<u>9600 bps</u>	<u>6</u>	19200 bps	7	38400 bps	0*	57600 bps	1*	115 kbps	2*	6				
Baud rate	Value																			
4800 bps	5																			
<u>9600 bps</u>	<u>6</u>																			
19200 bps	7																			
38400 bps	0*																			
57600 bps	1*																			
115 kbps	2*																			
BYTEFRAME	<table border="1"> <thead> <tr> <th>Parity</th> <th>Stop Bits</th> <th>Value</th> </tr> </thead> <tbody> <tr> <td><u>No</u></td> <td rowspan="3">1</td> <td><u>0</u></td> </tr> <tr> <td>Even</td> <td>1</td> </tr> <tr> <td>Odd</td> <td>2</td> </tr> <tr> <td>No</td> <td>2</td> <td>3</td> </tr> </tbody> </table>	Parity	Stop Bits	Value	<u>No</u>	1	<u>0</u>	Even	1	Odd	2	No	2	3	0					
Parity	Stop Bits	Value																		
<u>No</u>	1	<u>0</u>																		
Even		1																		
Odd		2																		
No	2	3																		
DATALENGTH	8: FALSE	FALSE																		
ENDOFFRAMETIME	<table border="1"> <thead> <tr> <th>End of Frame Time</th> <th>Value</th> </tr> </thead> <tbody> <tr> <td><u>3 x Frame Time</u></td> <td><u>0</u></td> </tr> <tr> <td>100 ms</td> <td>1</td> </tr> <tr> <td>200 ms</td> <td>2</td> </tr> <tr> <td>500 ms</td> <td>3</td> </tr> <tr> <td>1s</td> <td>4</td> </tr> <tr> <td>1 ms</td> <td>5</td> </tr> <tr> <td>10 ms</td> <td>6</td> </tr> <tr> <td>50 ms</td> <td>7</td> </tr> </tbody> </table>	End of Frame Time	Value	<u>3 x Frame Time</u>	<u>0</u>	100 ms	1	200 ms	2	500 ms	3	1s	4	1 ms	5	10 ms	6	50 ms	7	0
End of Frame Time	Value																			
<u>3 x Frame Time</u>	<u>0</u>																			
100 ms	1																			
200 ms	2																			
500 ms	3																			
1s	4																			
1 ms	5																			
10 ms	6																			
50 ms	7																			
ASCIIRTU MODE	RTU: TRUE	TRUE																		
ERRORCHECKING	<table border="1"> <thead> <tr> <th>Error Check</th> <th>Value</th> </tr> </thead> <tbody> <tr> <td>ignored</td> <td>FALSE</td> </tr> <tr> <td><u>being processed</u></td> <td><u>TRUE</u></td> </tr> </tbody> </table>	Error Check	Value	ignored	FALSE	<u>being processed</u>	<u>TRUE</u>	TRUE												
Error Check	Value																			
ignored	FALSE																			
<u>being processed</u>	<u>TRUE</u>																			
EXTENDEDFUNCTIONS	<table border="1"> <thead> <tr> <th>Extended Functions</th> <th>Value</th> </tr> </thead> <tbody> <tr> <td><u>without</u></td> <td><u>FALSE</u></td> </tr> <tr> <td>available</td> <td>TRUE</td> </tr> </tbody> </table>	Extended Functions	Value	<u>without</u>	<u>FALSE</u>	available	TRUE	FALSE												
Extended Functions	Value																			
<u>without</u>	<u>FALSE</u>																			
available	TRUE																			
NOWATCHDOG	<table border="1"> <thead> <tr> <th>Watchdog</th> <th>Value</th> </tr> </thead> <tbody> <tr> <td><u>switched on</u></td> <td><u>FALSE</u></td> </tr> <tr> <td>switched off</td> <td>TRUE</td> </tr> </tbody> </table>	Watchdog	Value	<u>switched on</u>	<u>FALSE</u>	switched off	TRUE	FALSE												
Watchdog	Value																			
<u>switched on</u>	<u>FALSE</u>																			
switched off	TRUE																			

Terminating resistance

Make settings only when 750-812 or 750-815 is used.

- For 2-wire system
- For 4-wire system



750-873

Connect the computer to 750-873 and start the web browser.

Click [Modbus] on the browser menu. The password entry dialog appears. To log on as an administrator, enter "admin" for the user name and "wago" for the password, and click [OK].

Make settings for [Serial Port Settings] and [Modbus RTU Settings] on the screen. For more information, refer to the PLC manual issued by the manufacturer.

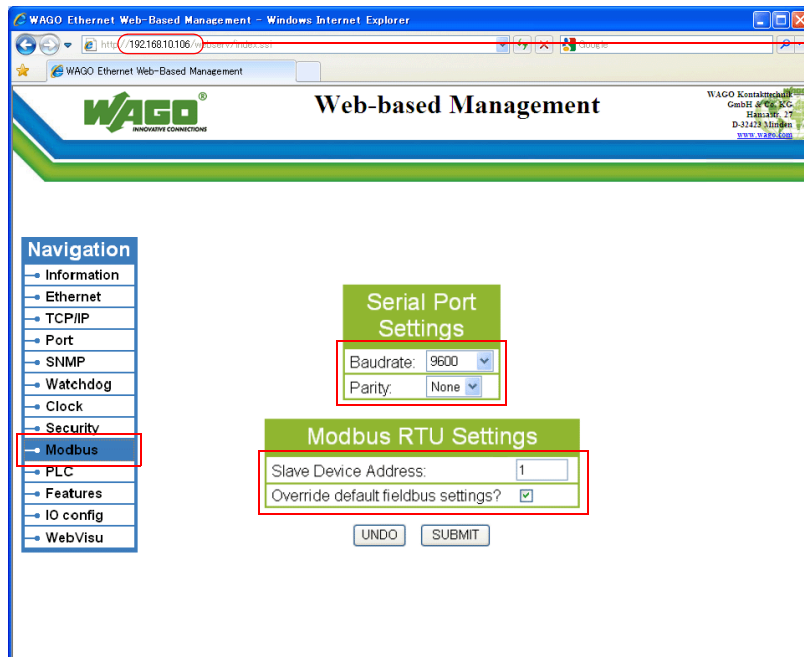

Enter the IP address of the bus coupler or bus controller on Internet Explorer, and press the [Enter] key to display the browser menu.

(Underlined setting: default)

Item	Setting	Remarks
Serial Port Settings	Baudrate	<u>9600</u> / 19200 / 57600 / 115K bps
	Parity	<u>None</u> / Odd / Even
Modbus RTU Settings	Slave Device Address	1 to 255
	Override default fieldbus settings?	Checked

* After settings are made, click [SUBMIT], and turn the power off and back on again.

Available Memory

The available memory setting range varies depending on the PLC model. Be sure to set within the range available for the PLC. Use [TYPE] when assigning the indirect memory for macro programs.

Memory	TYPE	Remarks
%MX (internal contact point)	00H	%MW as word device
%IX (input variable)	01H	%IW as word device
%QX (output variable)	02H	%QW as word device

52.1.2 750 Series (MODBUS Ethernet)

Communication Setting

Editor

Make the following settings on the editor. For more information, see Appendix 2 Ethernet.

- IP address for the TS unit
 - When specified on the screen data:
[System Setting] → [Ethernet Communication] → [Local Port IP Address]
 - When specified on the TS unit:
Main Menu screen → [Ethernet]
- Connection port on the TS unit
[System Setting] → [Device Connection Setting] → [Connect to:]
 - When using TCP/IP:
Select [Built-in LAN (TCP)].
 - When using UDP/IP:
Select [Built-in LAN (UDP)].
- Port number for the TS unit (for communication with PLC)
[System Setting] → [Device Connection Setting] → [Communication Setting]

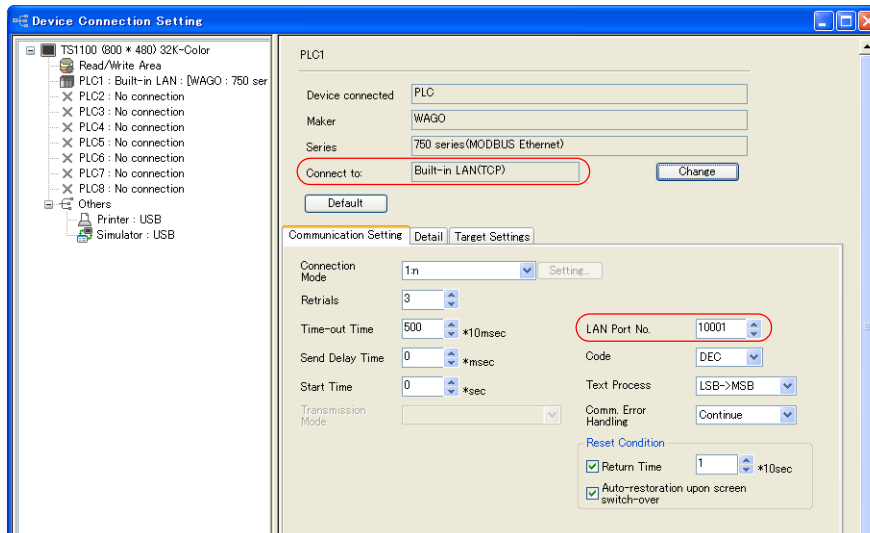

- IP address and port number of the PLC
[System Setting] → [Device Connection Setting] → [PLC Table]

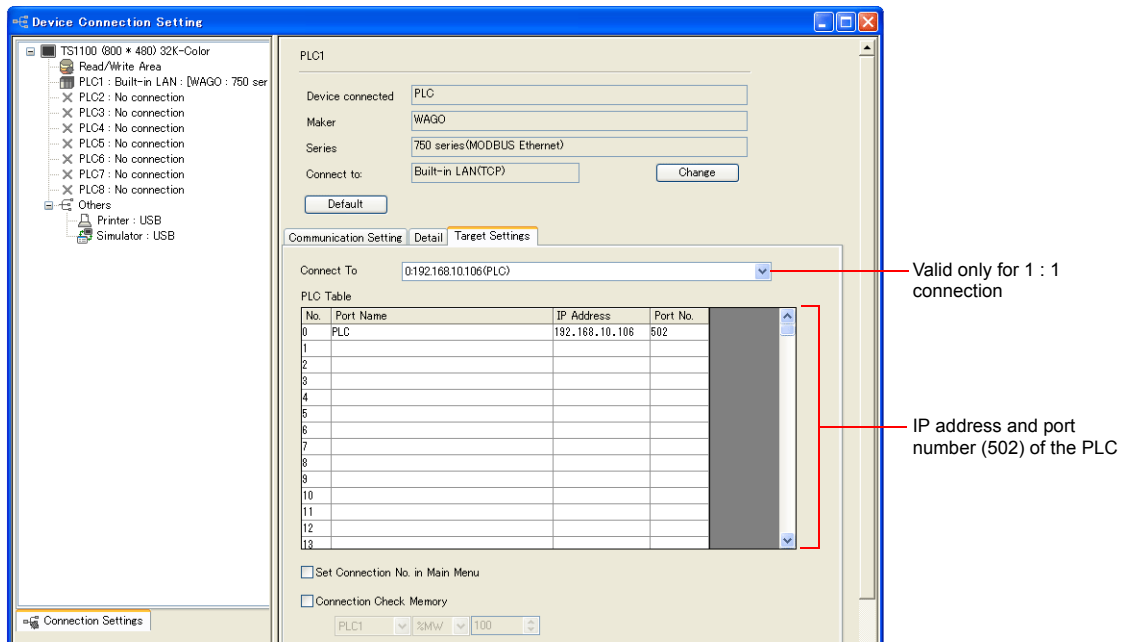

Bus Coupler / Bus Controller

Make PLC settings by using "WAGO BootP Server" or "WAGO Ethernet Settings". For more information, refer to the PLC manual issued by the manufacturer.

* For 750-342 and 750-842, only "WAGO BootP Server" can be used.

WAGO BootP Server

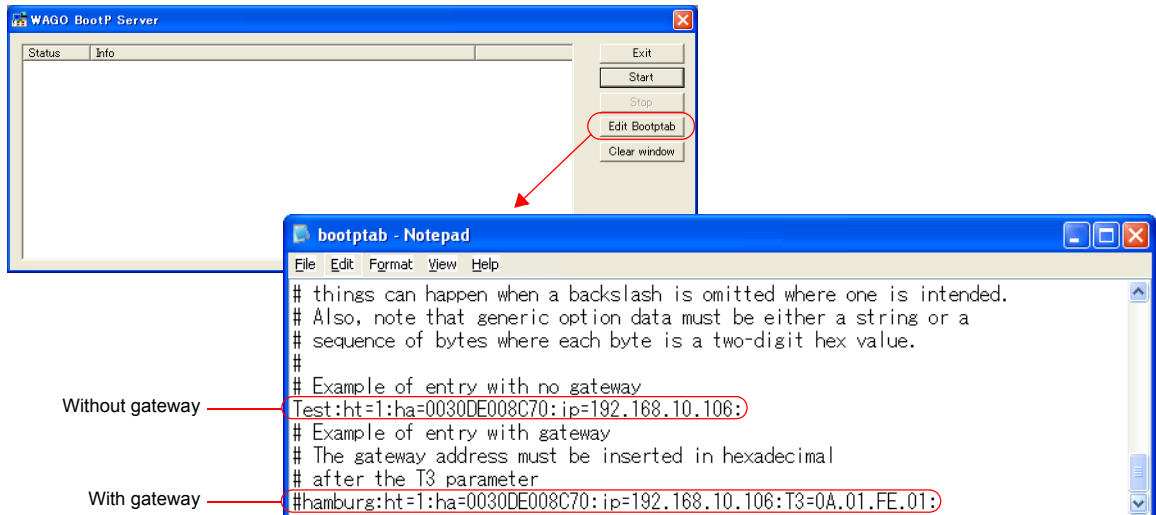

Example: Test:ht=1:ha:0030DE008C70:ip=192.168.10.106:

Node name	MAC address	IP address
Hardware type		

* When setting the subnet mask (sm) and gateway (gw), make settings following the IP address as shown below:

Example: Test:ht=1:ha=003-DE000002:ip=192.168.10.106:sm=255.255.255.0:T3=0A:01:FE:01:

Node name	MAC address	IP address	Subnet mask	Gateway (HEX)
Hardware type				

Contents	Setting
Node name	Use one-byte alphanumeric characters.
Hardware type	ht=1
MAC address	ha =MAC address (shown on the bus coupler or bus controller)
IP address table	ip =IP address of the PLC
Subnet mask	sm =subnet mask
Gateway	T3 =gateway address (HEX) * To be set when the bus coupler or bus controller lies beyond the gateway

- * When making settings for 750-871, set all DIP switches in the OFF positions.
- * The port number is fixed to "502".

Delete either "#" mark at the beginning of "with gateway" or "without gateway" and save the text file. The setting with no "#" mark will take effect.

Notes on setting the IP address using "BootP Server"

In the initial condition, the IP address set on "BootP Server" is cleared when the power is turned off and back on again. To retain the IP address even when the power has been turned off and back on again, the BootP protocol must be disabled after the IP address is set.

Connect the computer to the bus coupler or bus controller, and start the web browser. Remove the check mark from [BootP] for [Port] on the browser menu.

Click [SUBMIT] and turn the power off and back it on again. The BootP protocol becomes disabled.

- * When [Port] is clicked, the password may be required. For more information, see "Enabling Modbus UDP and Modbus TCP protocols" (page 52-8).

WAGO Ethernet Settings ([TCP/IP] tab window)

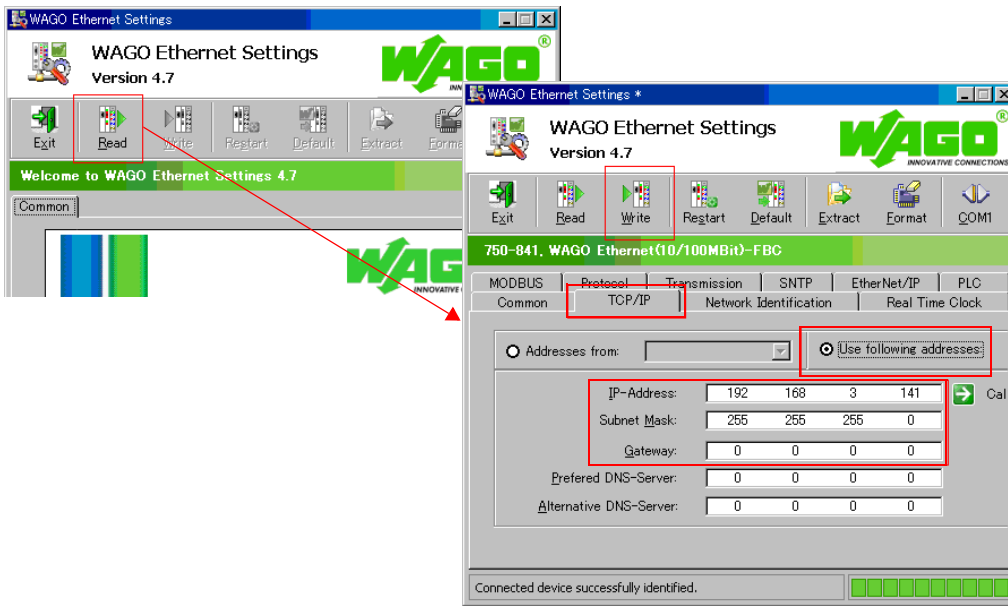

Contents	Setting	Remarks
IP-Address	Make settings in accordance with the network environment.	
Subnet Mask		
Gateway		

- * When making settings for 750-871, set all DIP switches in the OFF positions.
- * The port number is fixed to "502".

Enabling Modbus UDP and Modbus TCP protocols

When both Modbus UDP and Modbus TCP protocols are checked (enabled), communication using either protocol becomes possible without selecting a communication protocol on the bus coupler or bus controller. For more information, refer to the PLC manual issued by the manufacturer.

- Setting on the web browser
 - Connect the computer to the bus coupler or bus controller, and start the web browser.
 - Click [Port] on the browser menu. The password entry dialog appears. To log on as an administrator, enter "admin" for the user name and "wago" for the password, and click [OK].
 - Check both [Modbus UDP] and [Modbus TCP]. Click [SUBMIT], and turn the power off and back on again.
 - * In the initial condition, both Modbus UDP and Modbus TCP are enabled (checked).

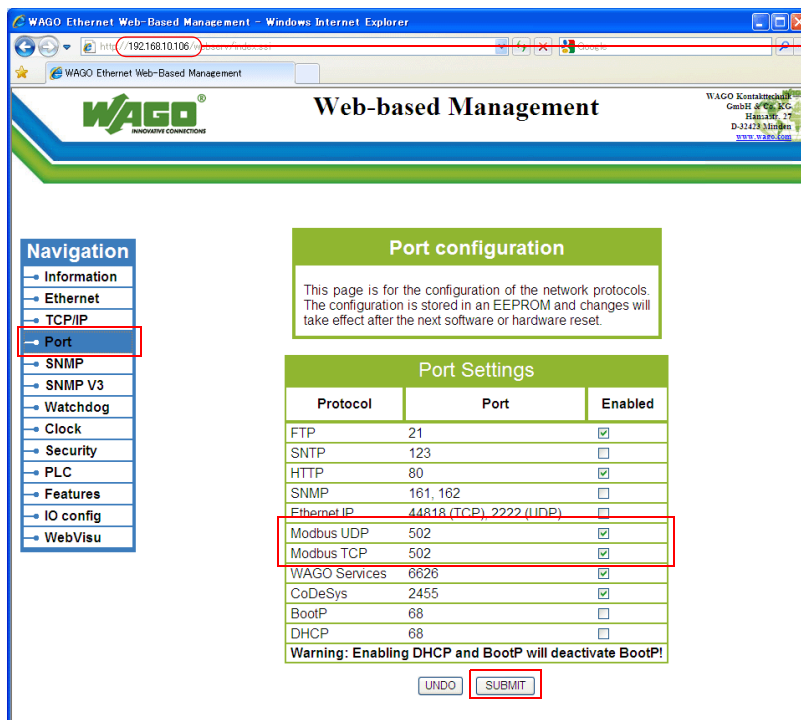

Enter the IP address of the bus coupler or bus controller on Internet Explorer, and press the [Enter] key to display the browser menu.

- Setting on the [WAGO Ethernet Settings] window ([Protocol] tab window)
 **"WAGO Ethernet Settings" cannot be used with 750-342 or 750-842.
 Check Modbus TCP (Port 502) and Modbus UDP (Port 502) in the [Protocol] tab window and write the settings into the bus coupler or bus controller.

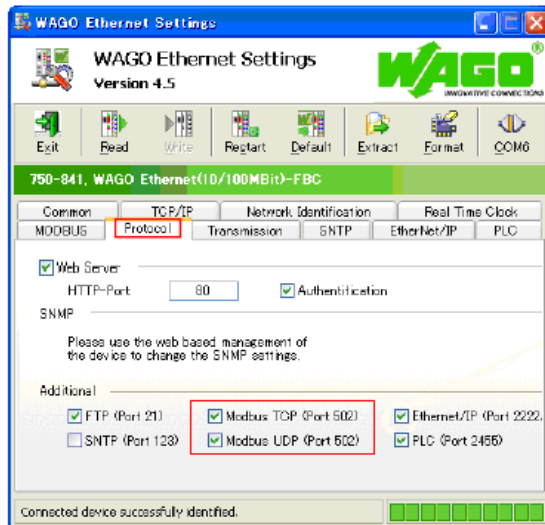

750-871

The least significant byte of the IP address can be set by the DIP switch.
 Note that the IP address must be set on "WAGO BootP Server" or "WAGO Ethernet Settings" in advance.
 When any of the DIP switches is set in the ON position upon power-on, the IP address set by the DIP switch will take effect.

DIP Switch	Setting Example	Remarks
	50 [DEC] (00110010 BIN)	Set the least significant byte of the IP address (1 to 254). Switch 1 = LSB, switch 8 = MSB

750-873

Connect the computer to the bus coupler or bus controller, and start the web browser. Be sure to uncheck [Override default fieldbus settings?] for [Modbus RTU Settings] in the [Modbus] browser menu.

- * When [Modbus] is clicked, the password may be required. For more information, see "750-873" (page 52-5).
- * In the initial condition, [Override default fieldbus settings?] is unchecked.

Available Memory

The available memory setting range varies depending on the PLC model. Be sure to set within the range available for the PLC. Use [TYPE] when assigning the indirect memory for macro programs.

Memory	TYPE	Remarks
%MX (internal contact point)	00H	%MW as word device
%IX (input variable)	01H	%IW as word device
%QX (output variable)	02H	%QW as word device

52.1.3 Wiring Diagrams

When Connected at COM1:

RS-422

Wiring diagram 1 - COM1

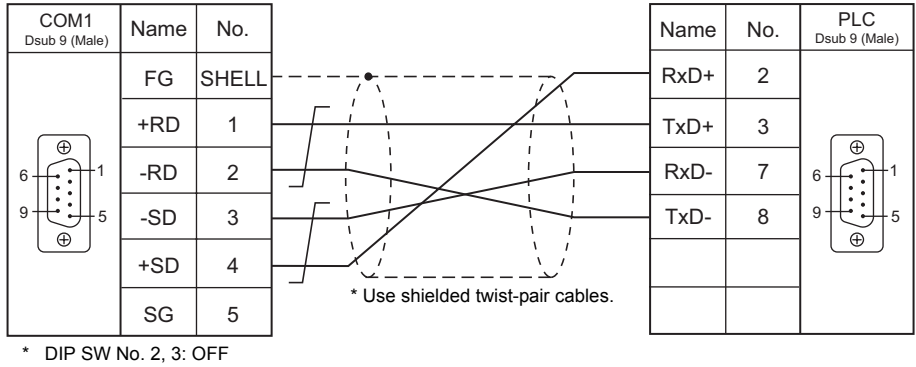

When Connected at COM2:

RS-232C

Wiring diagram 1 - COM2

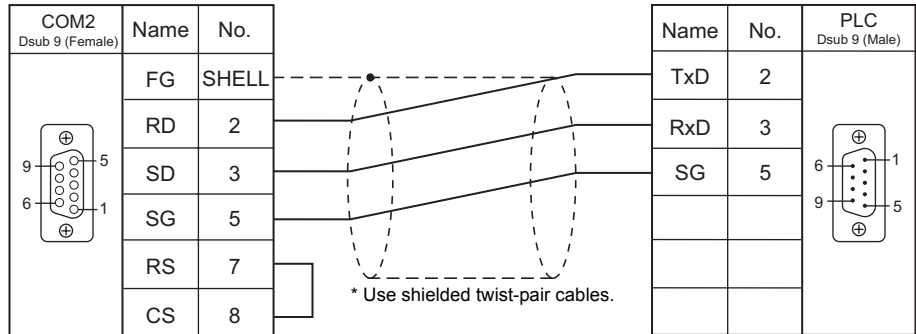

When Connected at COM3:

RS-485

Wiring diagram 1 - COM3

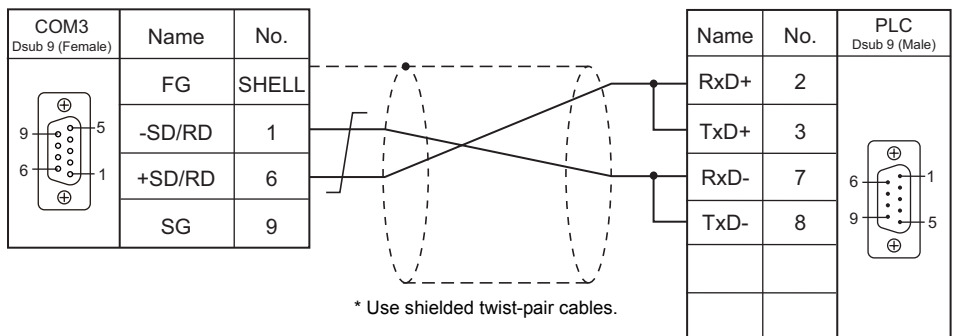

53. YAMAHA

53.1 Temperature Controller/Servo/Inverter Connection

53.1 Temperature Controller/Servo/Inverter Connection

Serial Connection

Robot Controller

PLC Selection on the Editor	Model	Port	Signal Level	TS Port	Connection	Lst File
RCX142	RCX142	COM	RS-232C	COM2	Wiring diagram 1 - COM2	Y_RCX142.lst
	RCX222					
	RCX240					

53.1.1 RCX142

Communication Setting

Editor

Communication setting

(Underlined setting: default)

Item	Setting	Remarks
Connection Mode	<u>1</u> / 1 / Multi-link2	
Signal Level	<u>RS-232C</u>	
Baud Rate	4800 / <u>9600</u> / 19200 / 38400 / 57600 bps	
Data Length	7 / <u>8 bits</u>	
Stop Bit	<u>1 bit</u>	
Parity	None / <u>Odd</u> / Even	
CR/LF	<u>CR</u> / CR/LF	

Robot Controller

RCX142/RCX240

Set communication parameters using the MPB programming box (RPB programming box for RCX240). For more information, refer to the instruction manual for the robot controller issued by the manufacturer.

(Underlined setting: default)

Mode	Sub Menu	Item	Setting	Remarks
SYSTEM	CMU	1. CMU mode	ONLINE	
		2. Data bits ^{*1}	7 / <u>8 bits</u>	
		3. Baud rate	4800 / <u>9600</u> / 19200 / 38400 / 57600 bps	
		4. Stop bit	<u>1</u> / 2 bits	
		5. Parity	NON / <u>ODD</u> / EVEN	
		6. Termination code	CR / <u>CRLF</u>	
		7. XON/XOFF control	NO	
		8. RTS/CTS control	<u>NO</u>	

*1 If Japanese is selected for the interface language, set the data bit to "8".

RCX222

Set communication parameters using the RPB programming box. For more information, refer to the instruction manual for the robot controller issued by the manufacturer.

(Underlined setting: default)

Mode	Sub Menu	Item	Setting	Remarks
SYSTEM	CMU	1. CMU mode	ONLINE	
		2. Data bits ^{*1}	7 / <u>8 bits</u>	
		3. Baud rate	4800 / <u>9600</u> / 19200 / 38400 / 57600 bps	
		4. Stop bit	<u>1</u> / 2 bits	
		5. Parity	NON / <u>ODD</u> / EVEN	
		6. Termination code	CR / <u>CRLF</u>	
		7. Flow control	NO	

*1 If Japanese is selected for the interface language, set the data bit to "8".

Available Memory

The available memory setting range varies depending on the models. Be sure to set within the range available for the device. Use [TYPE] when assigning the indirect memory for macro programs.

Memory	TYPE	Remarks
LANG (interface language)	00H	
ACSL (access level)	01H	
ARM1 (arm status (main robot))	02H	
ARM2 (arm status (sub robot))	03H	
BRKP (break point)	04H	
EXEL (execution level)	05H	
MODS (mode status)	06H	
ORIG (origin return status)	07H	Read only
ABSR (absolute reset status)	08H	Double-word, read only
SERV (servo status)	09H	Double-word, read only
SEQE (sequence program execution status)	0AH	
UNIT (point unit coordinate system)	0BH	
VERS (version)	0CH	Read only
WHR1 (current position in pulse coordinate system (main group))	0DH	Double-word, read only
WHR2 (current position in pulse coordinate system (sub group))	0EH	Double-word, read only
WXY1 (current position in XY coordinate system (main group))	0FH	Double-word, read only
WXY2 (current position in XY coordinate system (sub group))	10H	Double-word, read only
SIFT (shift status)	11H	Read only
HAND (hand status)	12H	Read only
MEMR (remaining memory capacity)	13H	Double-word, read only
EMGS (emergency stop status)	14H	Read only
SELF (error status in self-diagnosis)	15H	Read only
OPTS (option slot status)	16H	Read only
PRGS (program execution status)	17H	Read only
TSKS (running or suspended status of task)	18H	Read only
TSKM (task operation status)	19H	Read only

Memory: LANG (interface language)

Address	Name	Setting Range
0	Interface language	0: Japanese 1: English

Memory: ACSL (access level)

Address	Name	Setting Range
0	Access level	0 to 3

Memory: ARM1 (arm status (main robot))

Address	Name	Setting Range
0	Current arm setting	0: Right-hand system 1: Left-hand system
1	Arm setting at the time of program reset	0: Right-hand system 1: Left-hand system

Memory: ARM2 (arm status (sub robot))

Address	Name	Setting Range
0	Current arm setting	0: Right-hand system 1: Left-hand system
1	Arm setting at the time of program reset	0: Right-hand system 1: Left-hand system

Memory: BRKP (break point)

Address	Name	Setting Range
0	Line number of break point 1	0 to 19999
1	Line number of break point 2	0 to 19999
2	Line number of break point 3	0 to 19999
3	Line number of break point 4	0 to 19999

Memory: EXEL (execution level)

Address	Name	Setting Range
0	Execution level	0 to 8

Memory: MODS (mode status)

Address	Name	Setting Range
0	Mode status	0: AUTO 1: PROGRAM 2: MANUAL 3: SYSTEM

Memory: ORIG (origin return status)

Address	Name	Setting Range
0	Origin return status	0: Completed 1: Not completed

Memory: ABSR (absolute reset status)

Address	Name	Setting Range
0	Completed or not completed	0: Completed 1: Not completed
1	Status of each axis (output only when address 0 is set to "1" (absolute reset not completed))	00000000 to 99999999 XXXXXXXX ┌──────────┴──────────┐ └── Axis 1 0: Not completed : 1: Completed └── Axis 8 9: Not applicable

Memory: SERV (servo status)

Address	Name	Setting Range
0	Motor power ON/OFF status	0: Motor power ON 1: Motor power OFF
1	Status of each axis	00000000 to 99999999 XXXXXXXX ┌──────────┴──────────┐ └── Axis 1 0: Mechanical brake ON + dynamic brake ON : 1: Servo ON └── Axis 8 2: Mechanical brake OFF + dynamic brake OFF 9: Not applicable

Memory: SEQE (sequence program execution status)

Address	Name	Setting Range
0	Availability	0: Disabled 1: Enabled 3: Enabled, and output cleared at the time of emergency stop
1	Execution status	0: Stopped 1: In progress

Memory: UNIT (point unit coordinate system)

Address	Name	Setting Range
0	Point unit coordinate system	0: Joint coordinates in units of pulse 1: Cartesian coordinates in units of mm or deg.

Memory: VERS (version)

Address	Name	Setting Range
0	Host version	
1	Host revision	
2	MPB/RPB version	
3	Driver version 1	
4	Driver version 2	
5	Driver version 3	
6	Driver version 4	
7	Driver version 5	
8	Driver version 6	
9	Driver version 7	
10	Driver version 8	
11	Option unit version	

Memory: WHR1 (current position in pulse coordinate system (main group))

Address	Name	Setting Range
0	Current position of axis 1 in the pulse coordinate system (main group)	-999999 to 999999
1	Current position of axis 2 in the pulse coordinate system (main group)	-999999 to 999999
2	Current position of axis 3 in the pulse coordinate system (main group)	-999999 to 999999
3	Current position of axis 4 in the pulse coordinate system (main group)	-999999 to 999999
4	Current position of axis 5 in the pulse coordinate system (main group)	-999999 to 999999
5	Current position of axis 6 in the pulse coordinate system (main group)	-999999 to 999999

Memory: WHR2 (current position in pulse coordinate system (sub group))

Address	Name	Setting Range
0	Current position of axis 1 in the pulse coordinate system (sub group)	-999999 to 999999
1	Current position of axis 2 in the pulse coordinate system (sub group)	-999999 to 999999
2	Current position of axis 3 in the pulse coordinate system (sub group)	-999999 to 999999
3	Current position of axis 4 in the pulse coordinate system (sub group)	-999999 to 999999
4	Current position of axis 5 in the pulse coordinate system (sub group)	-999999 to 999999
5	Current position of axis 6 in the pulse coordinate system (sub group)	-999999 to 999999

Memory: WXY1 (current position in XY coordinate system (main group))

Address	Name	Setting Range
0	Current position of axis 1 in units of "mm" (main group)	-999999 to 999999
1	Current position of axis 2 in units of "mm" (main group)	-999999 to 999999
2	Current position of axis 3 in units of "mm" (main group)	-999999 to 999999
3	Current position of axis 4 in units of "mm" (main group)	-999999 to 999999
4	Current position of axis 5 in units of "mm" (main group)	-999999 to 999999
5	Current position of axis 6 in units of "mm" (main group)	-999999 to 999999

Memory: WXY2 (current position in XY coordinate system (sub group))

Address	Name	Setting Range
0	Current position of axis 1 in units of "mm" (sub group)	-999999 to 999999
1	Current position of axis 2 in units of "mm" (sub group)	-999999 to 999999
2	Current position of axis 3 in units of "mm" (sub group)	-999999 to 999999
3	Current position of axis 4 in units of "mm" (sub group)	-999999 to 999999
4	Current position of axis 5 in units of "mm" (sub group)	-999999 to 999999
5	Current position of axis 6 in units of "mm" (sub group)	-999999 to 999999

Memory: SIFT (shift status)

Address	Name	Setting Range
0	Shift number selected for main robot	0 to 9
1	Shift number selected for sub robot	0 to 9

Memory: HAND (hand status)

Address	Name	Setting Range
0	Hand number selected for main robot	0 to 3
1	Hand number selected for sub robot	4 to 7

Memory: MEMR (remaining memory capacity)

Address	Name	Setting Range
0	Remaining source area (unit: byte)	
1	Remaining object area (unit: byte)	

Memory: EMGS (emergency stop status)

Address	Name	Setting Range
0	Emergency stop status	0: Normal 1: Emergency stop

Memory: SELF (error status in self-diagnosis)

Address	Name	Setting Range
0 to 49	Error status 1	[Error group No.] . [Error category No.] : [Error message] (CHAR)
50 to 99	Error status 2	
100 to 149	Error status 3	
150 to 199	Error status 4	
200 to 249	Error status 5	

Memory: OPTS (option slot status)

Address	Name	Setting Range
0 to 49	Option slot status 1	Option board name (CHAR)
50 to 99	Option slot status 2	
100 to 149	Option slot status 3	
150 to 199	Option slot status 4	

Memory: PRGS (program execution status)

Address	Name	Setting Range
0 to 49	Name of currently selected program	Program name (CHAR)
50	Current task number	1 to 8
51	Line number of current program	1 to 9999
52	Priority of current task	17 to 47

Memory: TSKS (running or suspended status of task)

Address	Name	Setting Range
0	Number of task currently running or suspended (No. 1)	1 to 8
1	Number of task currently running or suspended (No. 2)	1 to 8
2	Number of task currently running or suspended (No. 3)	1 to 8
3	Number of task currently running or suspended (No. 4)	1 to 8
4	Number of task currently running or suspended (No. 5)	1 to 8
5	Number of task currently running or suspended (No. 6)	1 to 8
6	Number of task currently running or suspended (No. 7)	1 to 8
7	Number of task currently running or suspended (No. 8)	1 to 8

Memory: TSKM (task operation status)

Address	Name	Setting Range
0	Number of line being executed in task (No. 1)	1 to 9999
1	Task status (No. 1)	0: In progress 1: Suspended 2: Stopped
2	Priority (No. 1)	17 to 47
3	Number of line being executed in task (No. 2)	1 to 9999
4	Task status (No. 2)	0: In progress 1: Suspended 2: Stopped
5	Priority of task (No. 2)	17 to 47
6	Number of line being executed in task (No. 3)	1 to 9999
7	Task status (No. 3)	0: In progress 1: Suspended 2: Stopped
8	Priority of task (No. 3)	17 to 47
9	Number of line being executed in task (No. 4)	1 to 9999
10	Task status (No. 4)	0: In progress 1: Suspended 2: Stopped
11	Priority of task (No. 4)	17 to 47
12	Number of line being executed in task (No. 5)	1 to 9999
13	Task status (No. 5)	0: In progress 1: Suspended 2: Stopped
14	Priority of task (No. 5)	17 to 47
15	Number of line being executed in task (No. 6)	1 to 9999
16	Task status (No. 6)	0: In progress 1: Suspended 2: Stopped
17	Priority of task (No. 6)	17 to 47
18	Number of line being executed in task (No. 7)	1 to 9999
19	Task status (No. 7)	0: In progress 1: Suspended 2: Stopped
20	Priority of task (No. 7)	17 to 47
21	Number of line being executed in task (No. 8)	1 to 9999
22	Task status (No. 8)	0: In progress 1: Suspended 2: Stopped
23	Priority of task (No. 8)	17 to 47

PLC_CTL

Macro command "PLC_CTL F0 F1 F2"

Contents	F0	F1 (= \$u n)		F2
Program operation	1 - 8 (PLC1 - 8)	n	Station number	3
		n + 1	Command: 0	
		n + 2	0: RESET 1: RUN 2: STEP 3: SKIP 4: NEXT 5: STOP	
Switching of execution task	1 - 8 (PLC1 - 8)	n	Station number	2
		n + 1	Command: 1	
Manual speed change	1 - 8 (PLC1 - 8)	n	Station number	4
		n + 1	Command: 2	
		n + 2	0: Main robot 1: Sub robot	
Moving to absolute reset position	1 - 8 (PLC1 - 8)	n	Station number	5
		n + 1	Command: 3	
		n + 2	0: Main robot 1: Sub robot	
Absolute reset for each axis	1 - 8 (PLC1 - 8)	n	Station number	4
		n + 1	Command: 4	
		n + 2	0: Main robot 1: Sub robot	
Memory area initialization	1 - 8 (PLC1 - 8)	n	Station number	3
		n + 1	Command: 5	
		n + 2	0: Program data 1: Point data 2: Shift data 3: Hand data 4: Pallet data 5: Point comment data 6: All of above data (program, point, shift, hand, pallet and point comment) 7: Parameter data 8: All data	
Communication port initialization	1 - 8 (PLC1 - 8)	n	Station number	2
		n + 1	Command: 6	
Error log initialization	1 - 8 (PLC1 - 8)	n	Station number	2
		n + 1	Command: 7	
Resetting of internal emergency stop flag	1 - 8 (PLC1 - 8)	n	Station number	2
		n + 1	Command: 8	
Acquisition of controller configuration status	1 - 8 (PLC1 - 8)	n	Station number	2
		n + 1	Command: 9	
		n + 2 to n + 3	Acquired text	
Acquisition of message line information displayed on MPB/RPB	1 - 8 (PLC1 - 8)	n	Station number	2
		n + 1	Command: 10	
		n + 2 to n + 3	Acquired text	
Acquisition of error message	1 - 8 (PLC1 - 8)	n	Station number	4
		n + 1	Command: 11	
		n + 2	Top number of acquired data: 1 to 500	
		n + 3	Last number of acquired data: 1 to 500	
		n + 4 - n + 5	Acquired text	

Contents	F0	F1 (= \$u n)		F2
Acquisition of speed setting status	1 - 8 (PLC1 - 8)	n	Station number	2
		n + 1	Command: 12	
		n + 2	Setting for automatic movement speed (main group): 1 to 100	
		n + 3	Setting for manual movement speed (main group): 1 to 100	
		n + 4	Setting for automatic movement speed (sub group): 1 to 100	
Command execution interruption	1 - 8 (PLC1 - 8)	n	Station number	2
		n + 1	Command: 13	
Reading of point data	1 - 8 (PLC1 - 8)	n	Station number	3
		n + 1	Command: 14	
		n + 2	Point number: 0 to 9999	
		n + 3	Coordinate system 0: Pulse (integer) 1 or greater: mm (decimal places)	
		n + 4 to n + 5	Point data 1	
		n + 6 to n + 7	Point data 2	
		n + 8 to n + 9	Point data 3	
		n + 10 to n + 11	Point data 4	
		n + 12 to n + 13	Point data 5	
n + 14 to n + 15	Point data 6			
n + 16	Extended hand system flag setting 0: No setting 1: Right-hand system 2: Left-hand system			
Writing of point data	1 - 8 (PLC1 - 8)	n	Station number	17
		n + 1	Command: 15	
		n + 2	Point number: 0 to 9999	
		n + 3	Coordinate system 0: Pulse (integer) 1 or greater: mm (decimal places)	
		n + 4 to n + 5	Point data 1	
		n + 6 to n + 7	Point data 2	
		n + 8 to n + 9	Point data 3	
		n + 10 to n + 11	Point data 4	
		n + 12 to n + 13	Point data 5	
n + 14 to n + 15	Point data 6			
n + 16	Extended hand system flag setting 0: No setting 1: Right-hand system 2: Left-hand system			
Reading of parameter (controller)	1 - 8 (PLC1 - 8)	n	Station number	5
		n + 1	Command: 16	
		n + 2 to n + 4	Parameter label (six alphabetical characters)	
		n + 5	Type 0: Entire controller	
		n + 6 to n + 7	Parameter data	
n + 8 to n + 9	Comment			
Reading of parameter (main robot / main robot + sub robot)	1 - 8 (PLC1 - 8)	n	Station number	5
		n + 1	Command: 16	
		n + 2 to n + 4	Parameter label (six alphabetical characters)	
		n + 5	Type 1: Main robot 2: Main robot + sub robot	
		n + 6 to n + 7	Parameter data (main robot)	
		n + 8 to n + 9	Parameter data (sub robot)	
n + 10 to n + 11	Comment			

Contents	F0	F1 (= \$u n)		F2
Reading of parameter (4-axis/8-axis)	1 - 8 (PLC1 - 8)	n	Station number	5
		n + 1	Command: 16	
		n + 2 to n + 4	Parameter label (six alphabetical characters)	
		n + 5	Type 3: 4-axis 4: 8-axis	
		n + 6 to n + 7	Parameter data (axis 1)	
		n + 8 to n + 9	Parameter data (axis 2)	
		n + 10 to n + 11	Parameter data (axis 3)	
		n + 12 to n + 13	Parameter data (axis 4)	
		n + 14 to n + 15	Parameter data (axis 5)	
		n + 16 to n + 17	Parameter data (axis 6)	
		n + 18 to n + 19	Parameter data (axis 7)	
		n + 20 to n + 21	Parameter data (axis 8)	
		n + 22 to n + 23	Comment	
Writing of parameter (controller)	1 - 8 (PLC1 - 8)	n	Station number	$8 + (m + 1) / 2$
		n + 1	Command: 17	
		n + 2 to n + 4	Parameter label (six alphabetical characters)	
		n + 5	Type 0: Entire controller	
		n + 6 to n + 7	Parameter data	
n + 8 -	Comment: m			
Writing of parameter (main robot / main robot + sub robot)	1 - 8 (PLC1 - 8)	n	Station number	$10 + (m + 1) / 2$
		n + 1	Command: 17	
		n + 2 to n + 4	Parameter label (six alphabetical characters)	
		n + 5	Type 1: Main robot 2: Main robot + sub robot	
		n + 6 to n + 7	Parameter data (main robot)	
		n + 8 to n + 9	Parameter data (sub robot)	
n + 10 -	Comment: m			
Writing of parameter (4-axis/8-axis)	1 - 8 (PLC1 - 8)	n	Station number	$22 + (m + 1) / 2$
		n + 1	Command: 17	
		n + 2 to n + 4	Parameter label (six alphabetical characters)	
		n + 5	Type 3: 4-axis 4: 8-axis	
		n + 6 to n + 7	Parameter data (axis 1)	
		n + 8 to n + 9	Parameter data (axis 2)	
		n + 10 to n + 11	Parameter data (axis 3)	
		n + 12 to n + 13	Parameter data (axis 4)	
		n + 14 to n + 15	Parameter data (axis 5)	
		n + 16 to n + 17	Parameter data (axis 6)	
		n + 18 to n + 19	Parameter data (axis 7)	
n + 20 to n + 21	Parameter data (axis 8)			
n + 22 -	Comment: m			
Reading of shift coordinate value definition	1 - 8 (PLC1 - 8)	n	Station number	3
		n + 1	Command: 18	
		n + 2	Shift coordinate number: 0 to 9	
		n + 3	Coordinate system 0: Pulse (integer) 1 or greater: mm (decimal places)	
		n + 4 to n + 5	Shift coordinate 1 (S)	
		n + 6 to n + 7	Shift coordinate 2 (S)	
		n + 8 to n + 9	Shift coordinate 3 (S)	
		n + 10 to n + 11	Shift coordinate 4 (S)	
		n + 12 to n + 13	Shift coordinate 1 (SP)	
		n + 14 to n + 15	Shift coordinate 2 (SP)	
		n + 16 to n + 17	Shift coordinate 3 (SP)	
		n + 18 to n + 19	Shift coordinate 4 (SP)	
		n + 20 to n + 21	Shift coordinate 1 (SM)	
		n + 22 to n + 23	Shift coordinate 2 (SM)	
		n + 24 to n + 25	Shift coordinate 3 (SM)	
n + 26 to n + 27	Shift coordinate 4 (SM)			

Contents	F0	F1 (= \$u n)		F2
Writing of shift coordinate value definition	1 - 8 (PLC1 - 8)	n	Station number	28
		n + 1	Command: 19	
		n + 2	Shift coordinate number: 0 to 9	
		n + 3	Coordinate system 0: Pulse (integer) 1 or greater: mm (decimal places)	
		n + 4 to n + 5	Shift coordinate 1 (S)	
		n + 6 to n + 7	Shift coordinate 2 (S)	
		n + 8 to n + 9	Shift coordinate 3 (S)	
		n + 10 to n + 11	Shift coordinate 4 (S)	
		n + 12 to n + 13	Shift coordinate 1 (SP)	
		n + 14 to n + 15	Shift coordinate 2 (SP)	
		n + 16 to n + 17	Shift coordinate 3 (SP)	
		n + 18 to n + 19	Shift coordinate 4 (SP)	
		n + 20 to n + 21	Shift coordinate 1 (SM)	
		n + 22 to n + 23	Shift coordinate 2 (SM)	
n + 24 to n + 25	Shift coordinate 3 (SM)			
n + 26 to n + 27	Shift coordinate 4 (SM)			
Reading of hand definition	1 - 8 (PLC1 - 8)	n	Station number	3
		n + 1	Command: 20	
		n + 2	Hand number: 0 to 7	
		n + 3	Coordinate system 0: Pulse (integer) 1 or greater: mm (decimal places)	
		n + 4 to n + 5	Hand 1	
		n + 6 to n + 7	Hand 2	
		n + 8 to n + 9	Hand 3	
n + 10	Hand attachment to R axis 0: None 1: Attached			
Writing of hand definition	1 - 8 (PLC1 - 8)	n	Station number	11
		n + 1	Command: 21	
		n + 2	Hand number: 0 to 7	
		n + 3	Coordinate system 0: Pulse (integer) 1 or greater: mm (decimal places)	
		n + 4 to n + 5	Hand 1	
		n + 6 to n + 7	Hand 2	
		n + 8 to n + 9	Hand 3	
		n + 10	Hand attachment to R axis 0: None 1: Attached	

Contents	F0	F1 (= \$u n)	F2	
Reading of pallet definition	1 - 8 (PLC1 - 8)	n	Station number	3
		n + 1	Command: 22	
		n + 2	Pallet number: 0 to 19	
		n + 3	NX	
		n + 4	NY	
		n + 5	NZ	
		n + 6	Coordinate system 0: Pulse (integer) 1 or greater: mm (decimal places)	
		n + 7 to n + 8	Coordinate data 1 for P [1]	
		n + 9 to n + 10	Coordinate data 2 for P [1]	
		n + 11 to n + 12	Coordinate data 3 for P [1]	
		n + 13 to n + 14	Coordinate data 4 for P [1]	
		n + 15 to n + 16	Coordinate data 5 for P [1]	
		n + 17 to n + 18	Coordinate data 6 for P [1]	
		n + 19 to n + 20	Coordinate data 1 for P [2]	
		n + 21 to n + 22	Coordinate data 2 for P [2]	
		n + 23 to n + 24	Coordinate data 3 for P [2]	
		n + 25 to n + 26	Coordinate data 4 for P [2]	
		n + 27 to n + 28	Coordinate data 5 for P [2]	
		n + 29 to n + 30	Coordinate data 6 for P [2]	
		n + 31 to n + 32	Coordinate data 1 for P [3]	
		n + 33 to n + 34	Coordinate data 2 for P [3]	
		n + 35 to n + 36	Coordinate data 3 for P [3]	
		n + 37 to n + 38	Coordinate data 4 for P [3]	
		n + 39 to n + 40	Coordinate data 5 for P [3]	
		n + 41 to n + 42	Coordinate data 6 for P [3]	
		n + 43 to n + 44	Coordinate data 1 for P [4]	
		n + 45 to n + 46	Coordinate data 2 for P [4]	
		n + 47 to n + 48	Coordinate data 3 for P [4]	
		n + 49 to n + 50	Coordinate data 4 for P [4]	
		n + 51 to n + 52	Coordinate data 5 for P [4]	
		n + 53 to n + 54	Coordinate data 6 for P [4]	
		n + 55 to n + 56	Coordinate data 1 for P [5]	
		n + 57 to n + 58	Coordinate data 2 for P [5]	
n + 59 to n + 60	Coordinate data 3 for P [5]			
n + 61 to n + 62	Coordinate data 4 for P [5]			
n + 63 to n + 64	Coordinate data 5 for P [5]			
n + 65 to n + 66	Coordinate data 6 for P [5]			

Contents	F0	F1 (= \$u n)		F2	
Writing of pallet definition	1 - 8 (PLC1 - 8)	n	Station number	67	
		n + 1	Command: 23		
		n + 2	Pallet number: 0 to 19		
		n + 3	NX		
		n + 4	NY		
		n + 5	NZ		
		n + 6	Coordinate system 0: Pulse (integer) 1 or greater: mm (decimal places)		
		n + 7 to n + 8	Coordinate data 1 for P [1]		
		n + 9 to n + 10	Coordinate data 2 for P [1]		
		n + 11 to n + 12	Coordinate data 3 for P [1]		
		n + 13 to n + 14	Coordinate data 4 for P [1]		
		n + 15 to n + 16	Coordinate data 5 for P [1]		
		n + 17 to n + 18	Coordinate data 6 for P [1]		
		n + 19 to n + 20	Coordinate data 1 for P [2]		
		n + 21 to n + 22	Coordinate data 2 for P [2]		
		n + 23 to n + 24	Coordinate data 3 for P [2]		
		n + 25 to n + 26	Coordinate data 4 for P [2]		
		n + 27 to n + 28	Coordinate data 5 for P [2]		
		n + 29 to n + 30	Coordinate data 6 for P [2]		
		n + 31 to n + 32	Coordinate data 1 for P [3]		
		n + 33 to n + 34	Coordinate data 2 for P [3]		
		n + 35 to n + 36	Coordinate data 3 for P [3]		
		n + 37 to n + 38	Coordinate data 4 for P [3]		
		n + 39 to n + 40	Coordinate data 5 for P [3]		
		n + 41 to n + 42	Coordinate data 6 for P [3]		
		n + 43 to n + 44	Coordinate data 1 for P [4]		
		n + 45 to n + 46	Coordinate data 2 for P [4]		
		n + 47 to n + 48	Coordinate data 3 for P [4]		
		n + 49 to n + 50	Coordinate data 4 for P [4]		
		n + 51 to n + 52	Coordinate data 5 for P [4]		
		n + 53 to n + 54	Coordinate data 6 for P [4]		
		n + 55 to n + 56	Coordinate data 1 for P [5]		
n + 57 to n + 58	Coordinate data 2 for P [5]				
n + 59 to n + 60	Coordinate data 3 for P [5]				
n + 61 to n + 62	Coordinate data 4 for P [5]				
n + 63 to n + 64	Coordinate data 5 for P [5]				
n + 65 to n + 66	Coordinate data 6 for P [5]				
Reading of device port	1 - 8 (PLC1 - 8)	n	Station number	4	
		n + 1	Command: 24		
		n + 2	Device port 0: DI port 1: DO port 2: MO port 3: TO port 4: LO port 5: SI port 6: SO port		
		n + 3	Port number: 0 to 7, 10 to 17, 20 to 27		
		n + 4	Point data		
Writing of device port	1 - 8 (PLC1 - 8)	n	Station number	5	
		n + 1	Command: 25		
		n + 2	Device port 1: DO port 2: MO port 3: TO port 4: LO port 6: SO port		
		n + 3	Port number: 0 to 7, 10 to 17, 20 to 27		
		n + 4	Point data		

Contents	F0	F1 (= \$u n)		F2
Reading of dynamic variable (Data type: integer/real number)	1 - 8 (PLC1 - 8)	n	Station number	15
		n + 1	Command: 26	
		n + 2 to n + 9	Variable name (max. 16 characters)	
		n + 10	Variable type 0: Simple variable 1: One-dimensional array variable 2: Two-dimensional array variable 3: Three-dimensional array variable	
		n + 11	Subscript for one dimension *1	
		n + 12	Subscript for two dimensions *2	
		n + 13	Subscript for three dimensions *3	
		n + 14	Data type 0: Integer 1: Real number	
n + 15 to n + 16	Data			
Reading of dynamic variable (Data type: text)	1 - 8 (PLC1 - 8)	n	Station number	15
		n + 1	Command: 26	
		n + 2 to n + 9	Variable name (max. 16 characters)	
		n + 10	Variable type 0: Simple variable 1: One-dimensional array variable 2: Two-dimensional array variable 3: Three-dimensional array variable	
		n + 11	Subscript for one dimension *1	
		n + 12	Subscript for two dimensions *2	
		n + 13	Subscript for three dimensions *3	
		n + 14	Data type 2: Text	
n + 15 -	Data (max. 70 characters)			
Writing of dynamic variable (Data type: integer/real number)	1 - 8 (PLC1 - 8)	n	Station number	17
		n + 1	Command: 27	
		n + 2 to n + 9	Variable name (max. 16 characters)	
		n + 10	Variable type 0: Simple variable 1: One-dimensional array variable 2: Two-dimensional array variable 3: Three-dimensional array variable	
		n + 11	Subscript for one dimension *1	
		n + 12	Subscript for two dimensions *2	
		n + 13	Subscript for three dimensions *3	
		n + 14	Data type 0: Integer 1: Real number	
n + 15 to n + 16	Data			
Writing of dynamic variable (Data type: text)	1 - 8 (PLC1 - 8)	n	Station number	15 + (m + 1) / 2
		n + 1	Command: 27	
		n + 2 to n + 9	Variable name (max. 16 characters)	
		n + 10	Variable type 0: Simple variable 1: One-dimensional array variable 2: Two-dimensional array variable 3: Three-dimensional array variable	
		n + 11	Subscript for one dimension *1	
		n + 12	Subscript for two dimensions *2	
		n + 13	Subscript for three dimensions *3	
		n + 14	Data type 2: Text	
n + 15 -	Data (max. 70 characters): m			
Robot language execution	1 - 8 (PLC1 - 8)	n	Station number	2 + (m + 1) / 2
		n + 1	Command: 28	
		n + 2 -	Command text: m	

Contents	F0	F1 (= \$u n)		F2
Inching	1 - 8 (PLC1 - 8)	n	Station number	5
		n + 1	Command: 29	
		n + 2	0: Main robot 1: Sub robot	
		n + 3	Specified axis 1: X axis 2: Y axis 3: Z axis 4: R axis 5: A axis 6: B axis	
		n + 4	Direction of movement 0: Positive direction 1: Negative direction	
JOG	1 - 8 (PLC1 - 8)	n	Station number	5
		n + 1	Command: 30	
		n + 2	0: Main robot 1: Sub robot	
		n + 3	Specified axis 1: X axis 2: Y axis 3: Z axis 4: R axis 5: A axis 6: B axis	
		n + 4	Direction of movement 0: Positive direction 1: Negative direction	
Origin return	1 - 8 (PLC1 - 8)	n	Station number	4
		n + 1	Command: 31	
		n + 2	0: Main robot 1: Sub robot	
		n + 3	Specified axis 1: X axis 2: Y axis 3: Z axis 4: R axis 5: A axis 6: B axis	
		n + 4	Direction of movement 0: Positive direction 1: Negative direction	
Teaching	1 - 8 (PLC1 - 8)	n	Station number	4
		n + 1	Command: 32	
		n + 2	0: Main robot 1: Sub robot	
		n + 3	Point number: 0 to 9999	
		n + 4	Variable number: 0 to 7	
Reading of static variable	1 - 8 (PLC1 - 8)	n	Station number	4
		n + 1	Command: 34	
		n + 2	Data type 0: Integer (SGI) 1: Real number (SGR)	
		n + 3	Variable number: 0 to 7	
		n + 4 to n + 5	Data	
Writing of static variable	1 - 8 (PLC1 - 8)	n	Station number	6
		n + 1	Command: 35	
		n + 2	Data type 0: Integer (SGI) 1: Real number (SGR)	
		n + 3	Variable number: 0 to 7	
		n + 4 to n + 5	Data	

 Return data: Data stored from controller to TS series

*1 Valid in the case where a number other than "0" (simple variable) is specified for the variable type.

*2 Valid in the case where "2" (two-dimensional array variable) or "3" (three-dimensional array variable) is specified for the variable type.

*3 Valid in the case where "3" (three-dimensional array variable) is specified for the variable type.

53.1.2 Wiring Diagrams

When Connected at COM2:

RS-232C

Wiring diagram 1 - COM2

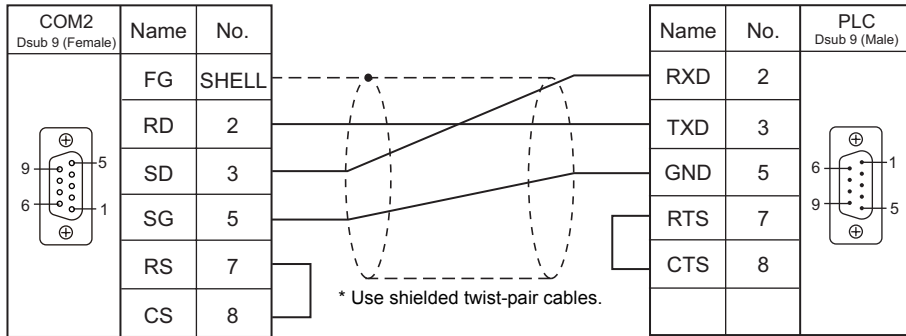

54. Yamatake

54.1 PLC Connection

54.2 Temperature Controller/Servo/Inverter Connection

54.1 PLC Connection

Serial Connection

PLC Selection on the Editor	Model	Port	Signal Level	TS Port	Connection	Ladder Transfer *1
MX series	MX50	LOAD connector (CN7)	RS-232C	COM2	Wiring diagram 1 - COM2	×
		ASCII connector (CN8)			Wiring diagram 2 - COM2	
	MX200	LOAD connector	RS-232C	COM2	Wiring diagram 2 - COM2	
		ASCII connector				

*1 For the ladder transfer function, see "Appendix 5 Ladder Transfer Function".

54.1.1 MX Series

Communication Setting

Editor

Communication setting

(Underlined setting: default)

Item	Setting	Remarks
Connection Mode	<u>1</u> : 1 / Multi-link2 / Multi-link2 (Ethernet)	
Signal Level	<u>RS-232C</u>	
Baud Rate	4800 / <u>9600</u> / 19200 bps	
Data Length	<u>8</u> bits	
Stop Bit	<u>1</u> / 2 bits	
Parity	None / <u>Even</u>	
Target Port No.	<u>1</u> to 63, 127	

PLC

MX50

Communication setting

Make the following settings using the application software. For more information, refer to the PLC manual issued by the manufacturer.

(Underlined setting: default)

Item	Setting	Remarks
Baud rate	4800 / <u>9600</u> / 19200 bps	
Data type	<u>Even parity 1 STOP</u> No parity 2 STOP	

Station number

Set a station number using the DIP switches.

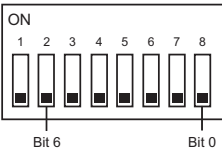
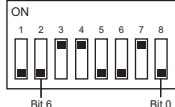
DipSW	Setting	Remarks
	1 to 63, 127 (Set a binary number using bits 0 to 6.)	Example: Station No. 50 50(DEC) = 0110010(BIN) 

* Set SW No. 1 to OFF at all times.

Calendar

This model is equipped with a calendar function; however, the calendar data cannot be written from the TS series. Thus, time correction must be performed on the PLC side.

MX200

Make the following settings on the front panel. For more information, refer to the PLC manual issued by the manufacturer.

LOAD connector

(Underlined setting: default)

Communication Setup Mode		Setting	Remarks
LOAD connector setting	Item 0: Address setting	1 to 63 (DEC): 1 to 63 7F(HEX): 127	Settings can also be made in the PLC application software. For more information, refer to the PLC manual issued by the manufacturer.
	Item 1: Baud rate	48: 4800 bps <u>96: 9600 bps</u> 192: 19200 bps	
	Item 2: Communication mode	<u>8E1: data length 8 bits, even parity, 1 stop bit</u> 8n2: data length 8 bits, without parity, 2 stop bits	

ASCII connector

(Underlined setting: default)

Communication Setup Mode		Setting	Remarks
ASCII connector setting	Item 0: Baud rate	48: 4800 bps <u>96: 9600 bps</u> 192: 19200 bps	Settings can also be made in the PLC application software. For more information, refer to the PLC manual issued by the manufacturer.
	Item 1: Data length	7b: 7 bits <u>8b: 8 bits</u>	
	Item 2: Parity bit	<u>EP: Even</u> oP: Odd nP: None	
	Item 3: Stop bit	<u>1S: 1 bit</u> 2S: 2 bits	
	Item 4: Connector usage	Ldr: LOAD connector	
	Item 5: Connecting device selection	CPL: Yamatake communication support device	
	Item 7: RTS control	<u>non: No RTS control</u>	
	Item 8: Signal level selection	<u>232: RS-232C</u>	

Station number

Make the following setting on the front panel.

(Underlined setting: default)

MX Address Display/Setting Mode	Setting	Remarks
Addr	<u>1</u> to 63	

Calendar

This model is equipped with a calendar function; however, the calendar data cannot be written from the TS series. Thus, time correction must be performed on the PLC side.

Available Memory

The available memory setting range varies depending on the models. Be sure to set within the range available for the device. Use [TYPE] when assigning the indirect memory for macro programs.

Memory	TYPE	Remarks
R (data register)	00H	R910, 929, 930, 956 to 987, 994 to 997: Read only
M (auxiliary relay)	01H	M920 to 940, 970 to 990: Read only
L (latch relay)	02H	
X (input relay)	03H	
Y (output relay)	04H	
TP (timer/current value)	05H	Data format: BCD
TS (timer/set value)	06H	Data format: BCD
CP (counter/current value)	07H	Data format: BCD
CS (counter/set value)	08H	Data format: BCD
T (timer/contact)	09H	
C (counter/contact)	0AH	
P (link register)	0BH	

54.1.2 Wiring Diagrams

When Connected at COM2:

RS-232C

Wiring diagram 1 - COM2

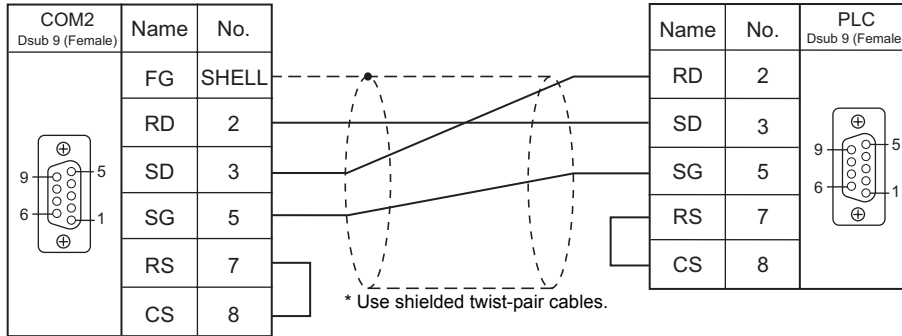

Wiring diagram 2 - COM2

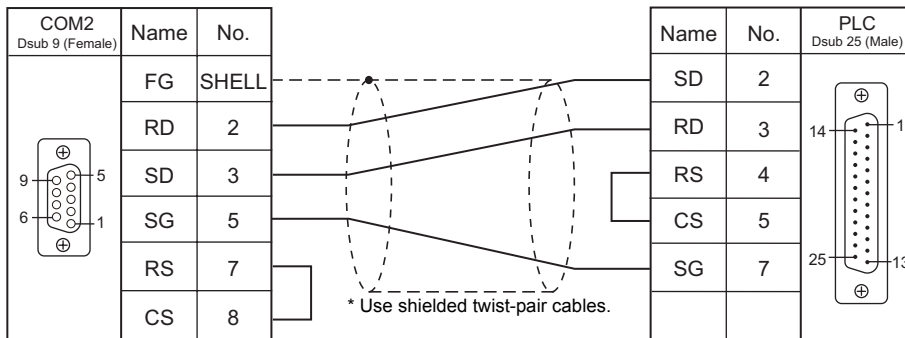

54.2 Temperature Controller/Servo/Inverter Connection

Serial Connection

Digital Indicating Controller

PLC Selection on the Editor	Model	Port	Signal Level	TS Port	Connection	Lst File
SDC10	SDC10xxxx05xx	Terminal on the back	RS-485	COM1	Wiring diagram 1 - COM1	SDC10.Lst
				COM3	Wiring diagram 1 - COM3	
SDC20	SDC20xxxx02xx SDC20xxxx04xx SDC20xxxx09xx	Terminal on the back	RS-422	COM1	Wiring diagram 2 - COM1	SDC20.Lst
			RS-485	COM3	Wiring diagram 2 - COM3	
	SDC20xxxx03xx SDC20xxxx05xx SDC20xxxx10xx	Terminal on the back	RS-232C	COM2	Wiring diagram 1 - COM2	
			RS-422	COM1	Wiring diagram 2 - COM1	
SDC21	SDC21xxxx03xx SDC21xxxx06xx SDC21xxxx08xx	Terminal on the back	RS-485	COM3	Wiring diagram 2 - COM3	
			SDC21xxxx04xx SDC21xxxx07xx SDC21xxxx09xx	Terminal on the back	RS-232C	COM2
SDC30/31	SDC30xxxx040xx SDC30xxxx041xx	Terminal on the back	RS-422	COM1	Wiring diagram 2 - COM1	SDC30.Lst
	SDC31xxxx045xx SDC31xxxx446xx SDC31xxxx546xx	Terminal on the back	RS-485	COM3	Wiring diagram 2 - COM3	
				SDC35xxxxx2xx SDC35xxxxx4xx SDC36xxxxx2xx SDC36xxxxx4xx	Terminal on the back	
SDC35/36	SDC15Txxxx03xx SDC15Txxxx06xx SDC25Txxxx2xx SDC26Txxxx2xx	Terminal on the back	RS-485	COM3	Wiring diagram 1 - COM3	None*1
				COM1	Wiring diagram 1 - COM1	
SDC40A	SDC40Axxxxxx2xx SDC40Axxxxxx3xx	Terminal on the back	RS-422	COM1	Wiring diagram 2 - COM1	SDC40A.Lst
			RS-485	COM3	Wiring diagram 2 - COM3	
			RS-232C	COM2	Wiring diagram 1 - COM2	
SDC40G	SDC40Gxxxx095xx	Additional terminal on the back	RS-422	COM1	Wiring diagram 2 - COM1	SDC40G.Lst
			RS-485	COM3	Wiring diagram 2 - COM3	

*1 Enter addresses manually by referring to the instruction manual for the controller.

Module-type Controller

PLC Selection on the Editor	Model	Port	Signal Level	TS Port	Connection	Lst File
DMC10	DMC10S DMC10D	CPL communication terminal	RS-485	COM1	Wiring diagram 1 - COM1	DMC10.Lst
				COM3	Wiring diagram 1 - COM3	
DMC50 (COM)	DMC50ME20X DMC50MR20X	RS-485 port 1	RS-422	COM1	Wiring diagram 2 - COM1	DMC50.Lst
			RS-485	COM3	Wiring diagram 2 - COM3	
	Display communication port	RS-485	COM1	Wiring diagram 3 - COM1		
		COM3	Wiring diagram 3 - COM3			
DMC50CH40X DMC50CH20X DMC50CS40X DMC50CS20X	Display communication port	RS-485	COM1	Wiring diagram 3 - COM1		
			COM3	Wiring diagram 3 - COM3		
AHC2001	AHC2001	CPU	RS-232C	COM2	Wiring diagram 2 - COM2	AHC2001.Lst
			RS-232C	COM2	Wiring diagram 2 - COM2	
		SCU	RS-422	COM1	Wiring diagram 4 - COM1	
			RS-485	COM3	Wiring diagram 4 - COM3	
AHC2001+DC P31/32	AHC2001	SCU	RS-422	COM1	Wiring diagram 4 - COM1	AHC_DCP.Lst
			RS-485	COM3	Wiring diagram 4 - COM3	
	DCP31Axx0ASxx2xx DCP32AxxASxx2xx	Additional terminal on the back	RS-422	COM1	Wiring diagram 2 - COM1	
			RS-485	COM3	Wiring diagram 2 - COM3	
			IBS	Terminal block	RS-422	
RS-485	COM3	Wiring diagram 2 - COM3				

Program Controller

PLC Selection on the Editor	Model	Port	Signal Level	TS Port	Connection	Lst File
DCP31/32	DCP31Axx0ASxx2xx DCP32AxxxASxx2xx	Additional terminal on the back	RS-422	COM1	Wiring diagram 2 - COM1	DCP32.Lst
			RS-485	COM3	Wiring diagram 2 - COM3	

Instrumentation Network Module

PLC Selection on the Editor	CPU	Unit/Port	Signal Level	TS Port	Connection	Lst File
NX (CPL)	NX-D15 NX-D25 NX-D35	Built-in terminal NX-CB1N (terminal) NX-CB1R (terminal)	RS-485	COM1	Wiring diagram 1 - COM1	NX_CPL.Lst
				COM3	Wiring diagram 1 - COM3	
NX (MODBUS RTU)	NX-D15 NX-D25 NX-D35	Built-in terminal NX-CB1N (terminal) NX-CB1R (terminal)	RS-485	COM1	Wiring diagram 1 - COM1	NX_Mod.Lst
				COM3	Wiring diagram 1 - COM3	

Ethernet Connection

Instrumentation Network Module

PLC Selection on the Editor	CPU	Unit/Port	TCP/IP	UDP/IP	Port No.	Lst File
NX (MODBUS TCP/IP)	NX-D15 NX-D25 NX-D35	NX-CB1N NX-CB1R	○	×	502: Default (Max. 2 units)	NX_Mod_Eth.Lst
		NX-CR1	○	×		

54.2.1 SDC10

Communication Setting

Editor

Communication setting

(Underlined setting: default)

Item	Setting	Remarks
Connection Mode	1 : 1 / <u>1:n</u> / Multi-link2 / Multi-link2 (Ethernet)	
Signal Level	<u>RS-422/485</u>	
Baud Rate	4800 / <u>9600</u> bps	
Data Length	<u>8</u> bits	
Stop Bit	<u>1</u> / 2 bits	
Parity	None / Odd / <u>Even</u>	
Target Port No.	<u>1</u> to 31	

Controller

Make the following settings.

When the [PARA] key is held down for three seconds or longer in the run mode, the parameter mode is selected. When the [PARA] key is held down for three seconds or longer again, the setup mode is selected.

(Underlined setting: default)

Item	Indication	Setting	Remarks
Communication address	C22	1 to 31	Communication is disabled when "0" is set.
Communication condition	C23	<u>0: 9600 bps, 8 bits, even parity, 1 stop bit</u> 1: 9600 bps, 8 bits, without parity, 2 stop bit 2: 4800 bps, 8 bits, even parity, 1 stop bit 3: 4800 bps, 8 bits, without parity, 2 stop bit	

Available Memory

The available memory setting range varies depending on the models. Be sure to set within the range available for the device. Use [TYPE] when assigning the indirect memory for macro programs.

Memory	TYPE	Remarks
---	00H	Without "**": RAM With "**": RAM + EEPROM

* The number of times EEPROM can be reprogrammed is limited (approx. 100,000 times). Accordingly, we recommend that you write such a parameter as to be reprogrammed frequently into RAM, where the number of reprogramming times is not limited. However, when the parameter has been written into RAM, and the power is turned off and back on again, data in EEPROM is transferred.

For more information, refer to the instruction manual for the controller issued by the manufacturer.

54.2.2 SDC20

Communication Setting

Editor

Communication setting

(Underlined setting: default)

Item	Setting	Remarks
Connection Mode	1 : 1 / <u>1:n</u> / Multi-link2 / Multi-link2 (Ethernet)	
Signal Level	RS-232C / <u>RS-422/485</u>	
Baud Rate	4800 / <u>9600</u> bps	
Data Length	<u>8 bits</u>	
Stop Bit	<u>1</u> / 2 bits	
Parity	None / Odd / <u>Even</u>	
Target Port No.	<u>1</u> to 31	

Controller

Make the following settings.

(Underlined setting: default)

Item	Indication	Setting	Remarks
Communication address	C31	1 to 31	Communication is disabled when "0" is set.
Baud rate	C32	<u>0: 9600 bps</u> 1: 4800 bps	
Data type	C33	<u>0: 8 bits, 1 stop bit, even parity</u> 1: 8 bits, 2 stop bit, without parity	

Available Memory

The available memory setting range varies depending on the models. Be sure to set within the range available for the device. Use [TYPE] when assigning the indirect memory for macro programs.

Memory	TYPE	Remarks
---	00H	Without "**": RAM With "**": RAM + EEPROM

* The number of times EEPROM can be reprogrammed is limited (approx. 100,000 times). Accordingly, we recommend that you write such a parameter as to be reprogrammed frequently into RAM, where the number of reprogramming times is not limited. However, when the parameter has been written into RAM, and the power is turned off and back on again, data in EEPROM is transferred.

For more information, refer to the instruction manual for the controller issued by the manufacturer.

54.2.3 SDC21

Settings are the same as those described in "54.2.2 SDC20".

54.2.4 SDC30/31

Communication Setting

Editor

Communication setting

(Underlined setting: default)

Item	Setting	Remarks
Connection Mode	1 : 1 / <u>1:n</u> / Multi-link2 / Multi-link2 (Ethernet)	
Signal Level	<u>RS-422/485</u>	
Baud Rate	4800 / <u>9600</u> bps	
Data Length	<u>8</u> bits	
Stop Bit	<u>1</u> / 2 bits	
Parity	None / Odd / <u>Even</u>	
Target Port No.	<u>1</u> to 31	

Controller

Make the following settings.

When the [PARA] key is held down for three seconds or longer in the run mode, the parameter mode is selected. When the [PARA] key is held down for three seconds or longer again, the setup mode is selected.

(Underlined setting: default)

Item	Indication	Setting	Remarks
Communication address	C31	1 to 31	Communication is disabled when "0" is set.
Baud rate	C32	<u>0: 9600 bps</u> 1: 4800 bps	
Data type	C33	<u>0: 8 bits, 1 stop bit, even parity</u> 1: 8 bits, 2 stop bit, without parity	

Available Memory

The available memory setting range varies depending on the models. Be sure to set within the range available for the device. Use [TYPE] when assigning the indirect memory for macro programs.

Memory	TYPE	Remarks
---	00H	Without "**": RAM With "**": RAM + EEPROM

* The number of times EEPROM can be reprogrammed is limited (approx. 100,000 times). Accordingly, we recommend that you write such a parameter as to be reprogrammed frequently into RAM, where the number of reprogramming times is not limited. However, when the parameter has been written into RAM, and the power is turned off and back on again, data in EEPROM is transferred.

For more information, refer to the instruction manual for the controller issued by the manufacturer.

54.2.5 SDC35/36

Communication Setting

Editor

Communication setting

(Underlined setting: default)

Item	Setting	Remarks
Connection Mode	1 : 1 / <u>1:n</u> / Multi-link2	
Signal Level	RS-232C / <u>RS-422/485</u>	
Baud Rate	4800 / 9600 / <u>19200</u> / 38400 bps	
Data Length	7 / <u>8</u> bits	
Stop Bit	<u>1</u> / 2 bits	
Parity	None / Odd / <u>Even</u>	
Target Port No.	<u>1</u> to 31	

Controller

CPL communication setting

(Underlined setting: default)

Item (Bank)	Indication	Setting	Remarks
Communication type (Setup bank)	C64	<u>0: CPL</u>	See "20. MODBUS".
Device address (Setup bank)	C65	1 to 127	Communication is disabled when "0" is set.
Baud rate (Setup bank)	C66	0: 4800 bps 1: 9600 bps <u>2: 19200 bps</u> 3: 38400 bps	
Data type: data length (Setup bank)	C67	0: 7 bits <u>1: 8 bits</u>	
Data type: parity (Setup bank)	C68	<u>0: Even</u> 1: Odd 2: None	
Data type: stop bit (Setup bank)	C69	<u>0: 1 bit</u> 1: 2 bits	

Available Memory

The available memory setting range varies depending on the models. Be sure to set within the range available for the device. Use [TYPE] when assigning the indirect memory for macro programs.

Memory	TYPE	Remarks
---	00H	Without "**": RAM With "**": RAM + EEPROM

* The number of times EEPROM can be reprogrammed is limited (approx. 100,000 times). Accordingly, we recommend that you write such a parameter as to be reprogrammed frequently into RAM, where the number of reprogramming times is not limited. However, when the parameter has been written into RAM, and the power is turned off and back on again, data in EEPROM is transferred.

For more information, refer to the instruction manual for the controller issued by the manufacturer.

54.2.6 SDC40A

Communication Setting

Editor

Communication setting

(Underlined setting: default)

Item	Setting	Remarks
Connection Mode	1 : 1 / <u>1:n</u> / Multi-link2 / Multi-link2 (Ethernet)	
Signal Level	RS-232C / <u>RS-422/485</u>	
Baud Rate	4800 / <u>9600</u> bps	
Data Length	<u>8</u> bits	
Stop Bit	<u>1</u> / 2 bits	
Parity	None / Odd / <u>Even</u>	
Target Port No.	<u>1</u> to 31	

Controller

Make the following settings.

(Underlined setting: default)

Item	Indication	Setting	Remarks
Communication address	C84	1 to 31	Communication is disabled when "0" is set.
Baud rate	C85	<u>0</u> : 9600 bps, <u>even parity</u> , <u>1 stop bit</u> 1: 9600 bps, without parity, 2 stop bit 2: 4800 bps, even parity, 1 stop bit 3: 4800 bps, without parity, 2 stop bit	

Available Memory

The available memory setting range varies depending on the models. Be sure to set within the range available for the device. Use [TYPE] when assigning the indirect memory for macro programs.

Memory	TYPE	Remarks
---	00H	Without "**": RAM With "**": RAM + EEPROM

* The number of times EEPROM can be reprogrammed is limited (approx. 100,000 times). Accordingly, we recommend that you write such a parameter as to be reprogrammed frequently into RAM, where the number of reprogramming times is not limited. However, when the parameter has been written into RAM, and the power is turned off and back on again, data in EEPROM is transferred.

For more information, refer to the instruction manual for the controller issued by the manufacturer.

54.2.7 SDC40G

Settings are the same as those described in "54.2.6 SDC40A".

54.2.8 DMC10

Communication Setting

Editor

Communication setting

(Underlined setting: default)

Item	Setting	Remarks
Connection Mode	1 : 1 / <u>1:n</u> / Multi-link2	
Signal Level	RS-232C / <u>RS-422/485</u>	
Baud Rate	4800 / 9600 / <u>19200</u> bps	
Data Length	7 / <u>8</u> bits	
Stop Bit	<u>1</u> / 2 bits	
Parity	None / Odd / <u>Even</u>	
Target Port No.	<u>1</u> to 31	

Controller

Rotary switch for device address

MODULE ADDRESS	Setting	Remarks
	1 to F	Communication is disabled when "0" is set.

CPL communication setting

Make the following settings on the PC loader. (Underlined setting: default)

Setting Items	Setting	Remarks
CPL/MODBUS	<u>0</u> : CPL	See "20. MODBUS".
Baud rate	1: 4800 bps 2: 9600 bps 3: <u>19200</u> bps	
Data type	<u>0</u> : 8 bits / 1 bit / even 1: 8 bits / 2 bits / none	

Available Memory

The available memory setting range varies depending on the controller model. Be sure to set within the range available for the controller. Use [TYPE] when assigning the indirect memory for macro programs.

Memory	TYPE	Remarks
---	00H	Without "**": RAM With "**": RAM + EEPROM

* The number of times EEPROM can be reprogrammed is limited (approx. 100,000 times). Accordingly, we recommend that you write such a parameter as to be reprogrammed frequently into RAM, where the number of reprogramming times is not limited. However, when the parameter has been written into RAM, and the power is turned off and back on again, data in EEPROM is transferred.

For more information, refer to the instruction manual for the controller issued by the manufacturer.

54.2.9 DMC50 (COM)

Communication Setting

Editor

Communication setting

(Underlined setting: default)

Item	Setting	Remarks
Connection Mode	1 : 1 / <u>1:n</u> / Multi-link2	
Signal Level	RS-232C / <u>RS-422/485</u>	
Baud Rate	<u>9600</u> / 19200 / 38400 bps	
Data Length	<u>8</u> bits	
Stop Bit	<u>1</u> bit	
Parity	<u>Even</u>	
Target Port No.	<u>1</u> to 16	When connecting to the COM module: Station number: COM module Sub-station number: CTRL module
Sub-station No.	<u>0</u> to 16	

Controller

Rotary address for module address

MODULE ADDRESS	Setting	Remarks
	1 to F	Communication is disabled when "0" is set.

COM module: RS-485 port 1

Make the following settings on the PC loader.

(Underlined setting: default)

Setting Items	Contents	Remarks
Baud rate (port 1)	<u>9600 bps</u> 19200 bps 38400 bps	
Protocol (port 1)	<u>1: CPL communication</u>	

CTRL module: Display communication port

Make the following settings on the PC loader.

(Underlined setting: default)

Setting Items	Contents	Remarks
Baud rate for display communication port	<u>9600 bps</u> 19200 bps 38400 bps	

* The display communication port is a dedicated port for 1 : 1 communication.

Available Memory

The available memory setting range varies depending on the controller model. Be sure to set within the range available for the controller. Use [TYPE] when assigning the indirect memory for macro programs.

Memory (Parameter Type ID)	TYPE	Remarks
000 (NA area)	00H	Double-word
001 (H/W information)	01H	Double-word, read only
002 (calendar time setting)	02H	Double-word
021 (AI setting) high-resolution monitor: for standard input	03H	Double-word
022 (AI setting) special monitor	04H	Double-word
023 (AI setting) high-resolution monitor: for option input	05H	Double-word
041 (AUX-IN setting)	06H	Double-word
045 (AO setting)	07H	Double-word
061 (DO setting)	08H	Double-word
071 (TP setting)	09H	Double-word
074 (zener barrier adjustment value)	0AH	Double-word
0A1 (communication setting: for ME200)	0BH	Double-word, read only
0A2 (communication setting: for MR200)	0CH	Double-word, read only
0A3 (communication setting: front port)	0DH	Double-word, read only
0C1 (system status)	0EH	Double-word, read only
0C3 (calendar time display)	0FH	Double-word, read only
0C4 (log: system alarm)	10H	Double-word
0C5 (log: AI alarm)	11H	Double-word
0C6 (log: AUX-IN alarm)	12H	Double-word
0E1 (AI status)	13H	Double-word, read only
0E2 (AUX-IN setting)	14H	Double-word, read only
0E3 (AO status)	15H	Double-word
0E5 (DI status)	16H	Double-word, read only
0E6 (AO status)	17H	Double-word
0E7 (TP status)	18H	Double-word
0E8 (zener barrier adjustment count)	19H	Double-word, read only
0F1 (communication setting in use: for ME200)	1AH	Double-word, read only
0F2 (communication setting in use: for MR200)	1BH	Double-word, read only
0F3 (communication setting in use: front port)	1CH	Double-word, read only
201 (PID_A setting)	1DH	Double-word
202 (PID_A constant)	1EH	Double-word
203 (PID_A monitor)	1FH	Double-word, read only
211 (PID_CAS setting)	20H	Double-word
212 (PID_CAS constant: master side)	21H	Double-word
213 (PID_CAS constant: slave side)	22H	Double-word
214 (PID_CAS monitor)	23H	Double-word, read only
234 (Ra_PID setting)	24H	Double-word
235 (Ra_PID constant)	25H	Double-word
236 (Ra_PID monitor)	26H	Double-word, read only
241 (UP_PID setting)	27H	Double-word
242 (UP_PID constant)	28H	Double-word
243 (UP_PID monitor)	29H	Double-word, read only
301 (TBL/TBR setting)	2AH	Double-word
801 (user-defined parameter)	2BH	Double-word
802 (user-defined parameter)	2CH	Double-word
803 (user-defined parameter)	2DH	Double-word
804 (user-defined parameter)	2EH	Double-word
805 (user-defined parameter)	2FH	Double-word
806 (user-defined parameter)	30H	Double-word
80D (user-defined parameter)	31H	Double-word
80E (user-defined parameter)	32H	Double-word
E01 (user-defined parameter)	33H	Double-word
E02 (user-defined parameter)	34H	Double-word
E04 (user-defined parameter)	35H	Double-word
E05 (user-defined parameter)	36H	Double-word
E06 (user-defined parameter)	37H	Double-word
E07 (user-defined parameter)	38H	Double-word
E08 (user-defined parameter)	39H	Double-word

Memory (Parameter Type ID)	TYPE	Remarks
E0A (user-defined parameter)	3AH	Double-word
E12 (user-defined parameter)	3BH	Double-word
E13 (user-defined parameter)	3CH	Double-word
E14 (user-defined parameter)	3DH	Double-word
E15 (user-defined parameter)	3EH	Double-word
610 (user-defined parameter)	3FH	Double-word
C00 (pattern setup)	40H	Double-word
CF1 (pattern FB monitor)	41H	Double-word, read only
C01 (segment setup)	42H	Double-word
C02 (segment setup)	43H	Double-word
C03 (segment setup)	44H	Double-word
C04 (segment setup)	45H	Double-word
C05 (segment setup)	46H	Double-word
C06 (segment setup)	47H	Double-word
C07 (segment setup)	48H	Double-word
C08 (segment setup)	49H	Double-word
C09 (segment setup)	4AH	Double-word
C0A (segment setup)	4BH	Double-word
C0B (segment setup)	4CH	Double-word
C0C (segment setup)	4DH	Double-word
C0D (segment setup)	4EH	Double-word
C0E (segment setup)	4FH	Double-word
C0F (segment setup)	50H	Double-word
C10 (segment setup)	51H	Double-word
C11 (segment setup)	52H	Double-word
C12 (segment setup)	53H	Double-word
C13 (segment setup)	54H	Double-word
C14 (segment setup)	55H	Double-word
C15 (segment setup)	56H	Double-word
C16 (segment setup)	57H	Double-word
C17 (segment setup)	58H	Double-word
C18 (segment setup)	59H	Double-word
C19 (segment setup)	5AH	Double-word
C1A (segment setup)	5BH	Double-word
C1B (segment setup)	5CH	Double-word
C1C (segment setup)	5DH	Double-word
C1D (segment setup)	5EH	Double-word
C1E (segment setup)	5FH	Double-word
C1F (segment setup)	60H	Double-word

Address denotations

On the signal name reference list, every group ID is designated as "001". To access any group ID other than "001", input the desired ID via manual operation.

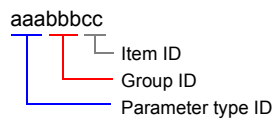

Indirect Memory Designation

- When the address (group ID) is 0 to FFH:

n + 0	15 Model	8 7 Memory type	0
n + 1	Group ID	Item ID	
n + 2	Expansion code *	Bit designation	
n + 3	00	Station number	

* In the expansion code, specify the sub-station number, and set which word, higher or lower, is to be read when a 2-word address is specified (expansion bit designation).

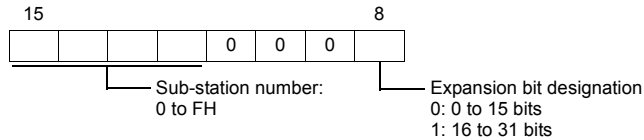

- When the address (group ID) is 100 to FFFH:

n + 0	15 Model	8 7 Memory type	4 3 0
n + 1	Group ID (medium/lower) *1	Item ID *1	
n + 2	000	Group ID (higher) *1	
n + 3	Expansion code *2	Bit designation	
n + 4	00	Station number	

*1 Set the address (group ID + item ID) for "n + 1" and "n + 2".

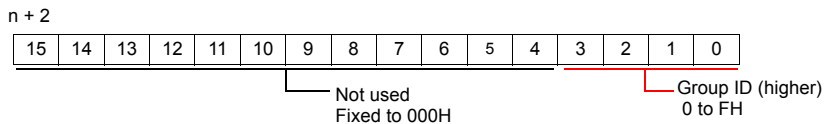
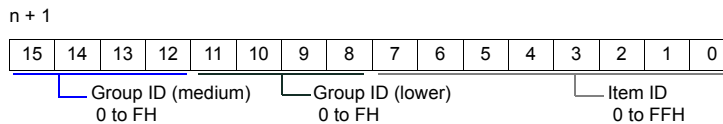
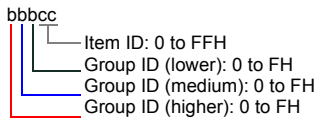

*2 In the expansion code, specify the sub-station number, and set which word, higher or lower, is to be read when a 2-word address is specified (expansion bit designation).

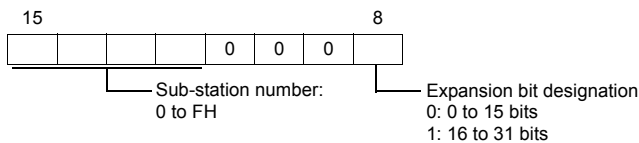

54.2.10 AHC2001

Communication Setting

Editor

Communication setting

(Underlined setting: default)

Item	Setting	Remarks
Connection Mode	1 : 1 / <u>1:n</u> / Multi-link2	
Signal Level	<u>RS-232C</u> / RS-422/485	
Baud Rate	9600 / <u>19200</u> / 38400 / 57600 bps	
Data Length	7 / <u>8</u> bits	
Stop Bit	<u>1</u> / 2 bits	
Parity	None / Odd / <u>Even</u>	
Target Port No.	<u>1</u> to 31	

Controller

CPU unit RS-232C setting

(Underlined setting: default)

Parameter Type ID	Group ID	Item ID	Setting Items	Contents	Remarks
0D2	001	01	Baud rate (port 1)	9600 bps <u>19200 bps</u> 38400 bps 57600 bps	
		02	Mode	<u>1: CPL</u>	
		03	CPL address	<u>1</u> to 31	

The following settings are fixed; parity: even, and stop bit: 1 bit.

SCU unit setting

(Underlined setting: default)

Parameter Type ID	Group ID	Item ID	Setting Items	Contents	Remarks
Exx *1	001 002 *2	01	Baud rate	9600 bps <u>19200 bps</u> 38400 bps	
		02	Data bit length	7: 7 bits <u>8: 8 bits</u>	
		03	Parity	0: None <u>1: Even</u> 2: Odd	
		04	Stop bit	<u>1: 1 bit</u> 2: 2 bits	
		05	Half duplex / full duplex	<u>0: Half duplex</u> 1: Full duplex	Half duplex: 2-wire connection Full duplex: 4-wire connection Invalid during RS-232C communication
		07	Protocol selection	2: <u>CPL server</u>	

*1 xx: Unit position 01 to 10H

The unit position varies depending on the mounting position of the SCU unit.

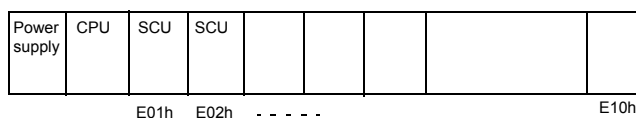

← Unit position E01H - E10H

*2 Group ID of port 1 (RS-232C): 001, group ID of port 2 (RS-485): 002

Available Memory

The available memory setting range varies depending on the controller model. Be sure to set within the range available for the controller. Use [TYPE] when assigning the indirect memory for macro programs.

Memory (Parameter Type ID)	TYPE	Remarks
000 (NA area)	00H	Double-word
001 (H/W information)	01H	Double-word, read only
002 (calendar time setting)	02H	Double-word
0C3 (calendar time display)	03H	Double-word, read only
0D0 (system information data)	04H	Double-word, read only
0D1 (unit information data)	05H	Double-word, read only
0D2 (CPU unit RS-232C setting)	06H	Double-word, read only
0D3 (system operation setting)	07H	Double-word, read only
0D4 (system configuration setting)	08H	Double-word, read only
0D5 (analog cycle setting)	09H	Double-word, read only
0D6 (memory capacity monitor)	0AH	Double-word, read only
201 (PID_A setting)	0BH	Double-word
202 (PID_A constant)	0CH	Double-word
203 (PID_A monitor)	0DH	Double-word, read only
211 (PID_CAS setting)	0EH	Double-word
212 (PID_CAS constant: master side)	0FH	Double-word
213 (PID_CAS constant: slave side)	10H	Double-word
214 (PID_CAS monitor)	11H	Double-word, read only
234 (Ra_PID setting)	12H	Double-word
235 (Ra_PID constant)	13H	Double-word
236 (Ra_PID monitor)	14H	Double-word, read only
241 (UP_PID setting)	15H	Double-word
242 (UP_PID constant)	16H	Double-word
243 (UP_PID monitor)	17H	Double-word, read only
301 (TBL/TBR setting)	18H	Double-word
600 (PLC link basic setting)	19H	Double-word, read only
801 (user-defined area)	1AH	Double-word
802 (user-defined area)	1BH	Double-word
803 (user-defined area)	1CH	Double-word
804 (user-defined area)	1DH	Double-word
805 (user-defined area)	1EH	Double-word
806 (user-defined area)	1FH	Double-word
807 (user-defined area)	20H	Double-word
808 (user-defined area)	21H	Double-word
809 (user-defined area)	22H	Double-word
80A (user-defined area)	23H	Double-word
80B (user-defined area)	24H	Double-word
80C (user-defined area)	25H	Double-word
80D (user-defined area)	26H	Double-word
80E (user-defined area)	27H	Double-word
80F (user-defined area)	28H	Double-word
810 (user-defined area)	29H	Double-word
811 (user-defined area)	2AH	Double-word
812 (user-defined area)	2BH	Double-word
813 (user-defined area)	2CH	Double-word
814 (user-defined area)	2DH	Double-word
815 (user-defined area)	2EH	Double-word
816 (user-defined area)	2FH	Double-word
817 (user-defined area)	30H	Double-word
820 (user-defined area)	31H	Double-word
E01 (user-defined area)	32H	Double-word
E02 (user-defined area)	33H	Double-word
E03 (user-defined area)	34H	Double-word
E04 (user-defined area)	35H	Double-word
F01 (user-defined area)	36H	Double-word
F02 (user-defined area)	37H	Double-word
F03 (user-defined area)	38H	Double-word
F04 (user-defined area)	39H	Double-word

Memory (Parameter Type ID)	TYPE	Remarks
F05 (user-defined area)	3AH	Double-word
F06 (user-defined area)	3BH	Double-word

Address denotations

On the signal name reference list, every group ID is designated as "001". To access any group ID other than "001", manually input the desired ID.

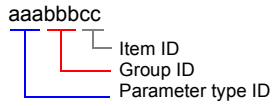

PLC_CTL

Macro command "PLC_CTL F0 F1 F2"

Contents	F0	F1 (= \$u n)		F2
		n		
ISaGRAF application Start/stop	1 - 8 (PLC1 - 8)	n	Station number	3
		n + 1	Command: 0	
		n + 2	0: Stop 1: Start	
ISaGRAF application Current status	1 - 8 (PLC1 - 8)	n	Station number	2
		n + 1	Command: 1	
		n + 2	0: Stop 1: Run	
Reserve for parameter backup	1 - 8 (PLC1 - 8)	n	Station number	2
		n + 1	Command: 2	

 Return data: Data stored from temperature controller to TS series

54.2.11 AHC2001+DCP31/32

Communication Setting

Editor

Communication setting

(Underlined setting: default)

Item	Setting	Remarks
Connection Mode	1 : 1 / <u>1:n</u> / Multi-link2	
Signal Level	RS-232C / <u>RS-422/485</u>	
Baud Rate	<u>9600</u> / 19200 / 38400 bps	
Data Length	7 / <u>8</u> bits	
Stop Bit	<u>1</u> / 2 bits	
Parity	None / Odd / <u>Even</u>	
Target Port No.	<u>1</u> to 31	

Controller

AHC2001 SCU unit setting

(Underlined setting: default)

Parameter Type ID	Group ID	Item ID	Setting Items	Contents	Remarks
Exx *1	002	01	Baud rate	9600 bps <u>19200 bps</u> 38400 bps	
		02	Data bit length	7: 7 bits <u>8: 8 bits</u>	
		03	Parity	0: None <u>1: Even</u> 2: Odd	
		04	Stop bit	<u>1: 1 bit</u> 2: 2 bits	
		05	Half duplex / full duplex	<u>0: Half duplex</u> 1: Full duplex	Half duplex: 2-wire connection Full duplex: 4-wire connection
		07	Protocol selection	2: CPL server	

*1 xx: Unit position 01 to 10H
The unit position varies depending on the mounting position of the SCU unit.

Power supply	CPU	SCU	SCU						
--------------	-----	-----	-----	--	--	--	--	--	--

E01h E02h - - - - - E10h

← Unit position E01H - E10H

DCP31/32

Setting group: Make the following setting on the setup data.

(Underlined setting: default)

Item	Indication	Setting	Remarks
Communication address	C84	1 to 31	Communication is disabled when "0" is set.
Baud rate	C85	<u>0: 9600 bps, even parity, 1 stop bit</u> 1: 9600 bps, without parity, 2 stop bit 2: 4800 bps, even parity, 1 stop bit 3: 4800 bps, without parity, 2 stop bit	
Data type	C93	<u>0: Additional terminal</u>	

IBS (air-fuel ratio controller)

Set the baud rate by the jumper setting (J2) on the CPU board.

(Underlined setting: default)

Item	Setting	Remarks
J2	RS-485 Baud rate setting	<u>9600 bps: short-circuited between 1 and 2, 3 and 4, open between 5 and 6</u> 4800 bps: open between 1 and 2, short-circuited between 3 and 4, open between 5 and 6

Available Memory

The available memory setting range varies depending on the controller model. Be sure to set within the range available for the controller. Use [TYPE] when assigning the indirect memory for macro programs.

Memory (Parameter Type ID)	TYPE	Remarks
000 (NA area)	00H	AHC2001, double-word
001 (H/W information)	01H	AHC2001, double-word, read only
002 (calendar time setting)	02H	AHC2001, double-word
0C3 (calendar time display)	03H	AHC2001, double-word, read only
0D0 (system information data)	04H	AHC2001, double-word, read only
0D1 (unit information data)	05H	AHC2001, double-word, read only
0D2 (CPU unit RS-232C setting)	06H	AHC2001, double-word, read only
0D3 (system operation setting)	07H	AHC2001, double-word, read only
0D4 (system configuration setting)	08H	AHC2001, double-word, read only
0D5 (analog cycle setting)	09H	AHC2001, double-word, read only
0D6 (memory capacity monitor)	0AH	AHC2001, double-word, read only
201 (PID_A setting)	0BH	AHC2001, double-word
202 (PID_A constant)	0CH	AHC2001, double-word
203 (PID_A monitor)	0DH	AHC2001, double-word, read only
211 (PID_CAS setting)	0EH	AHC2001, double-word
212 (PID_CAS constant: master side)	0FH	AHC2001, double-word
213 (PID_CAS constant: slave side)	10H	AHC2001, double-word
214 (PID_CAS monitor)	11H	AHC2001, double-word, read only
234 (Ra_PID setting)	12H	AHC2001, double-word
235 (Ra_PID constant)	13H	AHC2001, double-word
236 (Ra_PID monitor)	14H	AHC2001, double-word, read only
241 (UP_PID setting)	15H	AHC2001, double-word
242 (UP_PID constant)	16H	AHC2001, double-word
243 (UP_PID monitor)	17H	AHC2001, double-word, read only
301 (TBL/TBR setting)	18H	AHC2001, double-word
600 (PLC link basic setting)	19H	AHC2001, double-word, read only
801 (user-defined area)	1AH	AHC2001, double-word
802 (user-defined area)	1BH	AHC2001, double-word
803 (user-defined area)	1CH	AHC2001, double-word
804 (user-defined area)	1DH	AHC2001, double-word
805 (user-defined area)	1EH	AHC2001, double-word
806 (user-defined area)	1FH	AHC2001, double-word
807 (user-defined area)	20H	AHC2001, double-word
808 (user-defined area)	21H	AHC2001, double-word
809 (user-defined area)	22H	AHC2001, double-word
80A (user-defined area)	23H	AHC2001, double-word
80B (user-defined area)	24H	AHC2001, double-word
80C (user-defined area)	25H	AHC2001, double-word
80D (user-defined area)	26H	AHC2001, double-word
80E (user-defined area)	27H	AHC2001, double-word
80F (user-defined area)	28H	AHC2001, double-word
810 (user-defined area)	29H	AHC2001, double-word
811 (user-defined area)	2AH	AHC2001, double-word
812 (user-defined area)	2BH	AHC2001, double-word
813 (user-defined area)	2CH	AHC2001, double-word
814 (user-defined area)	2DH	AHC2001, double-word
815 (user-defined area)	2EH	AHC2001, double-word
816 (user-defined area)	2FH	AHC2001, double-word
817 (user-defined area)	30H	AHC2001, double-word

Memory (Parameter Type ID)	TYPE	Remarks
820 (user-defined area)	31H	AHC2001, double-word
E01 (user-defined area)	32H	AHC2001, double-word
E02 (user-defined area)	33H	AHC2001, double-word
E03 (user-defined area)	34H	AHC2001, double-word
E04 (user-defined area)	35H	AHC2001, double-word
F01 (user-defined area)	36H	AHC2001, double-word
F02 (user-defined area)	37H	AHC2001, double-word
F03 (user-defined area)	38H	AHC2001, double-word
F04 (user-defined area)	39H	AHC2001, double-word
F05 (user-defined area)	3AH	AHC2001, double-word
F06 (user-defined area)	3BH	AHC2001, double-word
--- (DCP)	3CH	DCP31/32

Address denotations

- AHC2001

On the signal name reference list, every group ID is designated as "001". To access any group ID other than "001", manually input the desired ID.

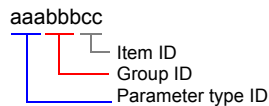

- DCP31/32

The address for DCP31/32 is not provided in the signal name reference list. Manually set the address by referring to the instruction manual for DCP31/32.

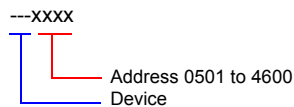

PLC_CTL

Macro command "PLC_CTL F0 F1 F2"

Contents	F0	F1 (= \$u n)		F2
		n	Station number	
ISaGRAF application Start/stop	1 - 8 (PLC1 - 8)	n + 1	Command: 0	3
		n + 2	0: Stop 1: Start	
		n	Station number	
ISaGRAF application Current status	1 - 8 (PLC1 - 8)	n + 1	Command: 1	2
		n + 2	0: Stop 1: Run	
		n	Station number	
Reserve for parameter backup	1 - 8 (PLC1 - 8)	n	Station number	2
		n + 1	Command: 2	

Return data: Data stored from temperature controller to TS series

54.2.12 DCP31/32

Communication Setting

Editor

Communication setting

(Underlined setting: default)

Item	Setting	Remarks
Connection Mode	1 : 1 / <u>1:n</u> / Multi-link2 / Multi-link2 (Ethernet)	
Signal Level	<u>RS-422/485</u>	
Baud Rate	4800 / <u>9600</u> bps	
Data Length	<u>8</u> bits	
Stop Bit	<u>1</u> / 2 bits	
Parity	None / Odd / <u>Even</u>	
Target Port No.	<u>1</u> to 31	

Controller

Setting group: Make the following setting on the setup data.

(Underlined setting: default)

Item	Indication	Setting	Remarks
Communication address	C84	1 to 31	Communication is disabled when "0" is set.
Baud rate	C85	<u>0</u> : 9600 bps, <u>even parity</u> , <u>1 stop bit</u> 1: 9600 bps, without parity, 2 stop bit 2: 4800 bps, even parity, 1 stop bit 3: 4800 bps, without parity, 2 stop bit	
Data type	C93	<u>0</u> : <u>Additional terminal</u>	

Available Memory

The available memory setting range varies depending on the models. Be sure to set within the range available for the device. Use [TYPE] when assigning the indirect memory for macro programs.

Memory	TYPE	Remarks
---	00H	

54.2.13 NX (CPL)

Communication Setting

Editor

Communication setting

(Underlined setting: default)

Item	Setting	Remarks
Connection Mode	1 : 1 / <u>1 : n</u> / Multi-link2 / Multi-link2 (Ethernet) / 1 : n Multi-link2 (Ethernet)	
Signal Level	RS-232C / <u>RS-422/485</u>	
Baud Rate	4800 / 9600 / <u>19200</u> / 38400 / 57600 / 115K bps	
Data Length	7 / <u>8</u> bits	
Stop Bit	<u>1</u> / 2 bits	
Parity	None / Odd / <u>Even</u>	
Target Port No.	1 to <u>127</u>	

Controller

Make the following settings on [Actual Module Configuration] in the [SLP-NX] software.

(Underlined setting: default)

Item	Setting	Remarks
RS-485 Address	1 to <u>127</u>	Communication is disabled when "0" is set.
RS-485 Protocol	CPL	
RS-485 Baud Rate	4800 / 9600 / <u>19200</u> / 38400 / 57600 / 115200 bps	
RS-485 Bit Length	7 / <u>8</u> bits	
RS-485 Parity Setting	None / Odd / <u>Even</u>	
RS-485 Stop Bit	<u>1</u> / 2 bits	

Available Memory

The available memory setting range varies depending on the models. Be sure to set within the range available for the device. Use [TYPE] when assigning the indirect memory for macro programs.

Memory	TYPE	Remarks
---	00H	

54.2.14 NX (MODBUS RTU)

Communication Setting

Editor

Communication setting

(Underlined setting: default)

Item	Setting	Remarks
Connection Mode	1 : 1 / <u>1:n</u> / Multi-link2 / Multi-link2 (Ethernet) / 1 : n Multi-link2 (Ethernet)	
Signal Level	RS-232C / <u>RS-422/485</u>	
Baud Rate	4800 / 9600 / <u>19200</u> / 38400 / 57600 / 115K bps	
Data Length	<u>8 bits</u>	
Stop Bit	<u>1</u> / 2 bits	
Parity	None / Odd / <u>Even</u>	
Target Port No.	1 to <u>127</u>	

Controller

Make the following settings on [Actual Module Configuration] in the [SLP-NX] software.

(Underlined setting: default)

Item	Setting	Remarks
RS-485 Address	1 to <u>127</u>	Communication is disabled when "0" is set.
RS-485 Protocol	MODBUS (RTU)	
RS-485 Baud Rate	4800 / 9600 / <u>19200</u> / 38400 / 57600 / 115200 bps	
RS-485 Bit Length	<u>8 bits</u>	
RS-485 Parity Setting	None / Odd / <u>Even</u>	
RS-485 Stop Bit	<u>1</u> / 2 bits	

Available Memory

The available memory setting range varies depending on the models. Be sure to set within the range available for the device. Use [TYPE] when assigning the indirect memory for macro programs.

Memory	TYPE	Remarks
---	02H	

54.2.15 NX (MODBUS TCP/IP)

Communication Setting

Editor

Make the following settings on the editor. For more information, see “Appendix 2 Ethernet”.

- IP address for the TS unit
 - When specified on the screen data:
[System Setting] → [Ethernet Communication] → [Local Port IP Address]
 - When specified on the TS unit:
Main Menu screen → [Ethernet]
- Port number for the TS unit (for communication with PLC)
[System Setting] → [Device Connection Setting] → [Communication Setting]

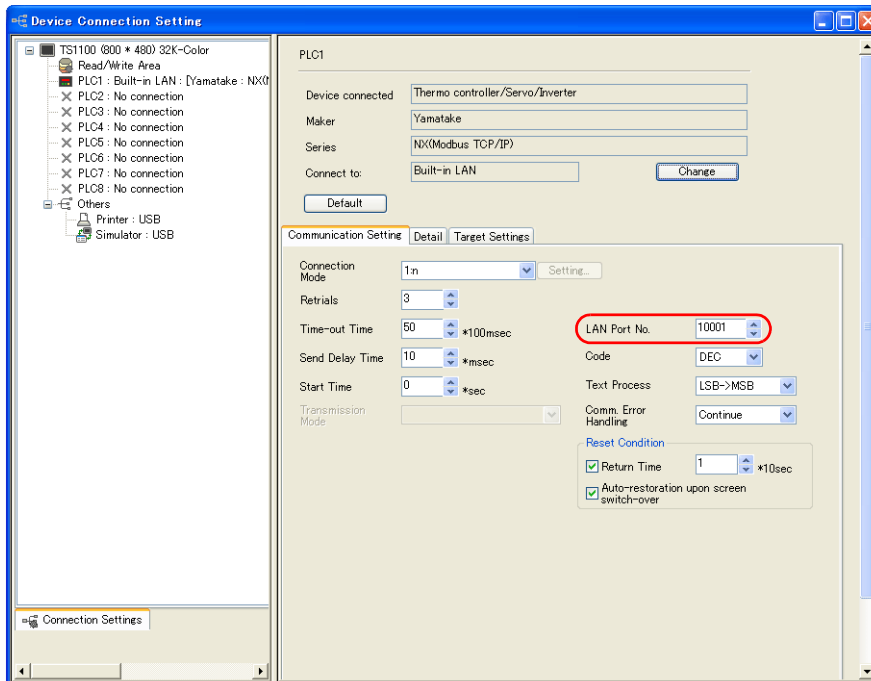

- IP address, port number, and maximum read value of the PLC
[System Setting] → [Device Connection Setting] → [PLC Table]

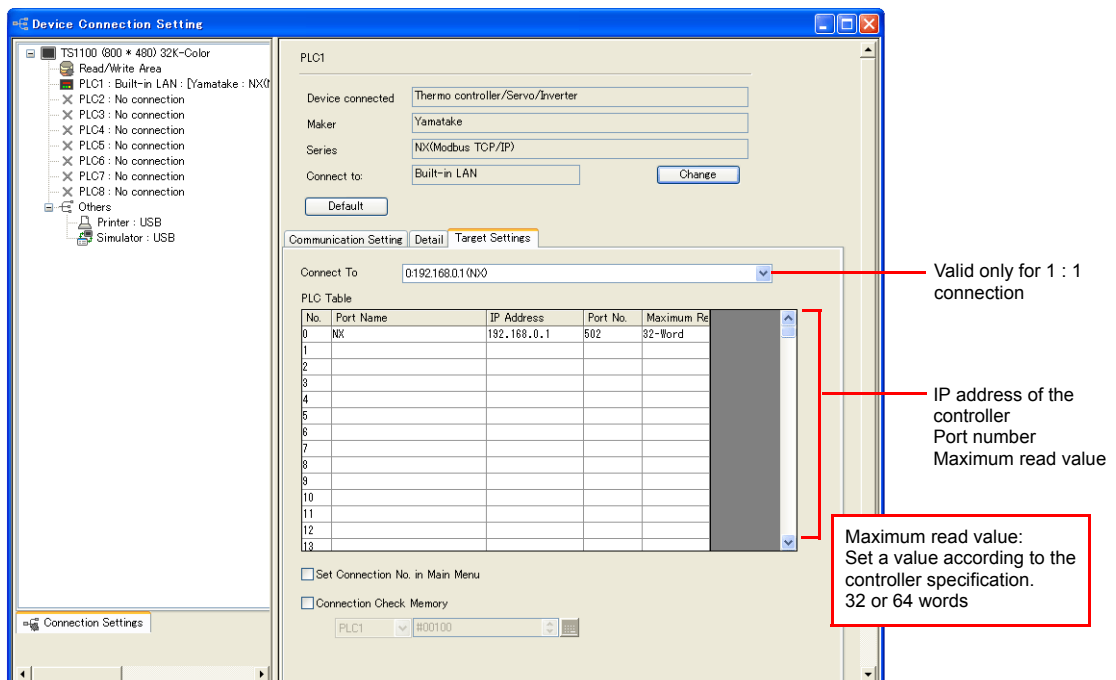

Controller

Make the following settings on [Actual Module Configuration] in the [SLP-NX] software.

Item		Remarks
IP Address	-	
IP Setting	Net mask	
	Default gateway	
Port Setting	MODBUS communication port number	Default: 502

Available Memory

The available memory setting range varies depending on the models. Be sure to set within the range available for the device. Use [TYPE] when assigning the indirect memory for macro programs.

Memory	TYPE	Remarks
---	02H	

54.2.16 Wiring Diagrams

When Connected at COM1:

RS-422/RS-485

Wiring diagram 1 - COM1

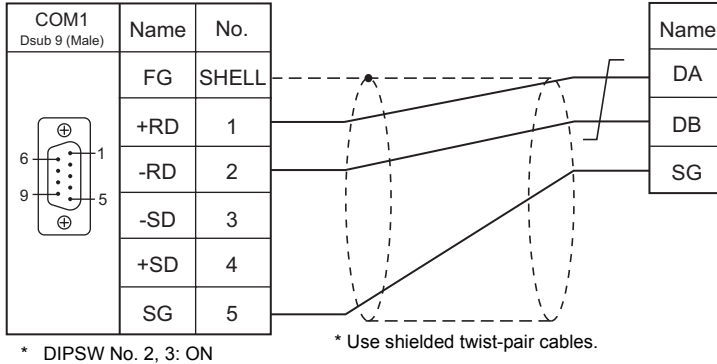

Wiring diagram 2 - COM1

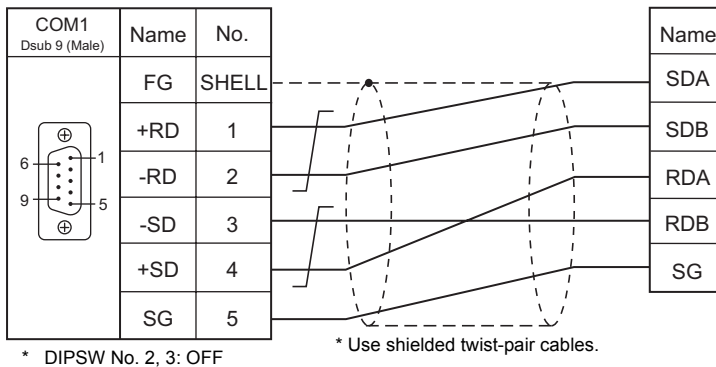

Wiring diagram 3 - COM1

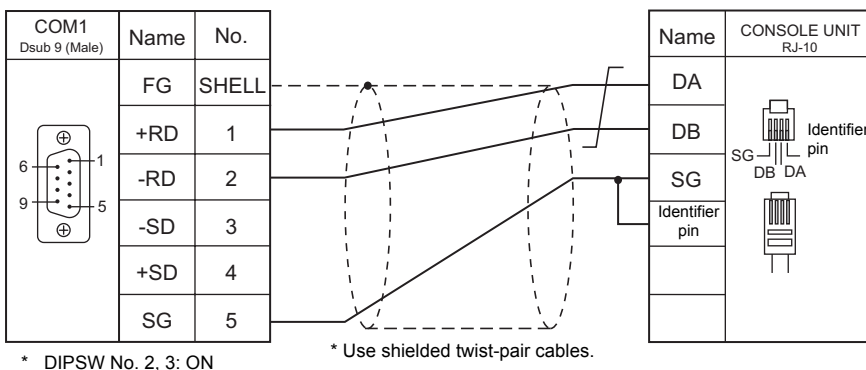

Wiring diagram 4 - COM1

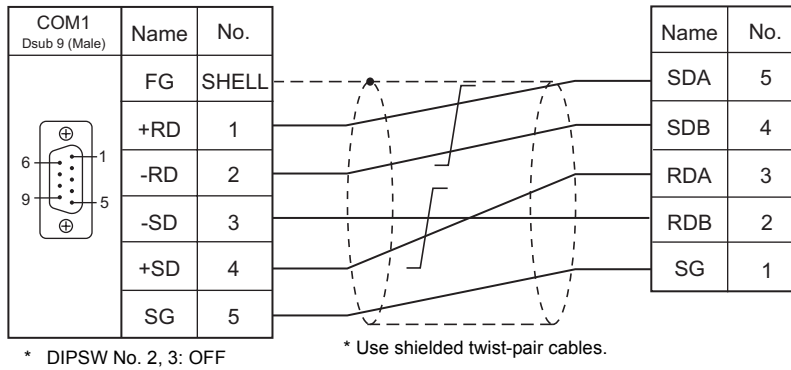

When Connected at COM2:

RS-232C

Wiring diagram 1 - COM2

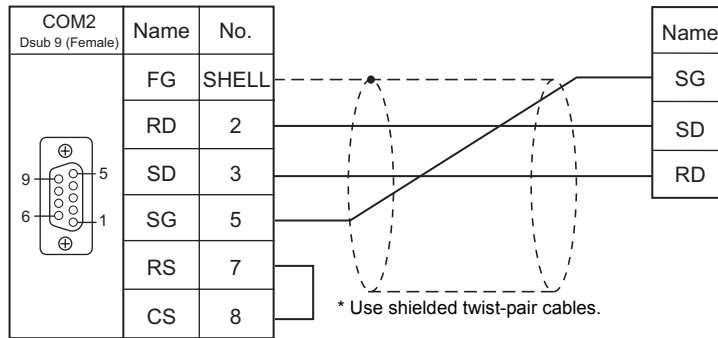

Wiring diagram 2 - COM2

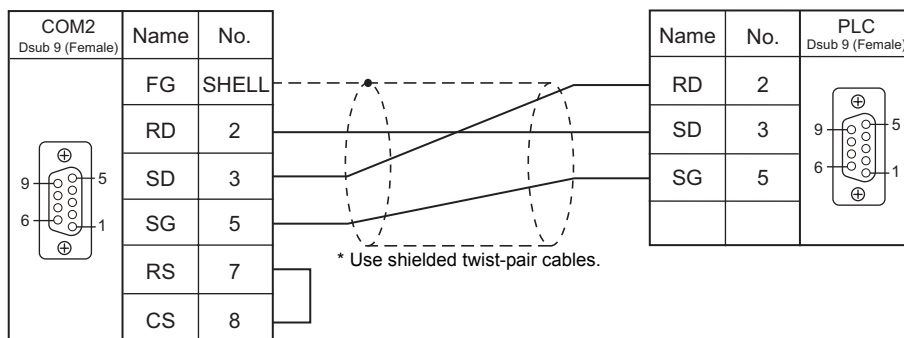

When Connected at COM3:

RS-485

Wiring diagram 1 - COM3

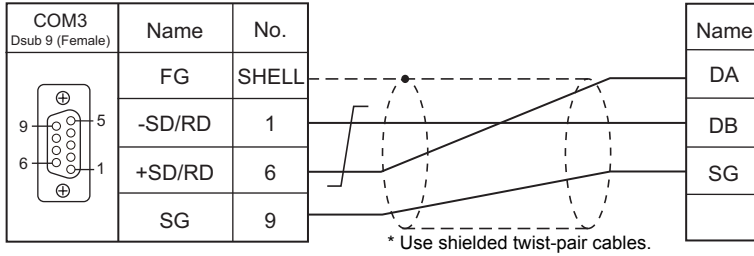

Wiring diagram 2 - COM3

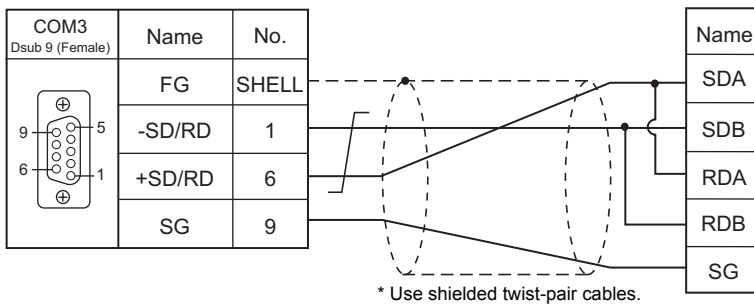

Wiring diagram 3 - COM3

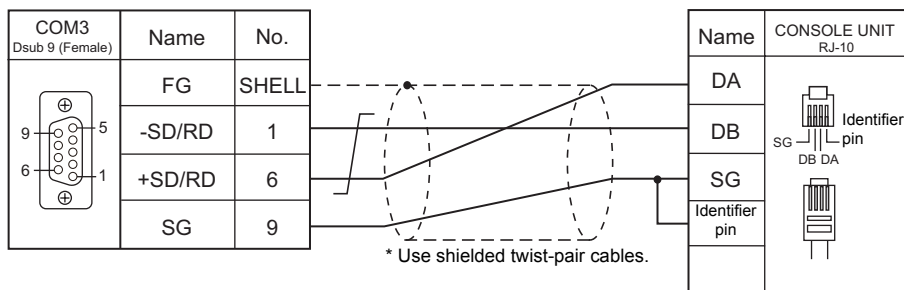

Wiring diagram 4 - COM3

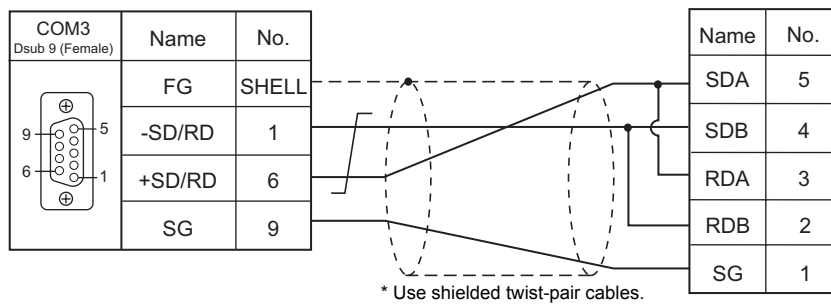

55. Yaskawa Electric

55.1 PLC Connection

55.1 PLC Connection

Serial Connection

PLC Selection on the Editor	CPU	Unit/Port	Signal Level	TS Port	Connection	Ladder Transfer ^{*1}	
Memobus	GL60 series	JAMSC-IF60 JAMSC-IF61 JAMSC-IF611	RS-232C	COM2	Wiring diagram 1 - COM2	×	
		JAMSC-IF612 JAMSC-IF613	RS-422	COM1 COM3	Wiring diagram 1 - COM1 Wiring diagram 1 - COM3		
	GL120 GL130 series	Memobus port on the CPU module	RS-232C	COM2	Wiring diagram 1 - COM2		
		JAMSC-120NOM 27100	RS-422	COM1 COM3	Wiring diagram 2 - COM1 Wiring diagram 2 - COM3		
	PROGIC-8	PORT2 on the CPU unit	RS-232C	COM2	Wiring diagram 2 - COM2		
	CP9200SH/ MP900	CP9200SH	CP-217IF	RS-232C	CN1		COM2
CN2					COM2	Wiring diagram 3 - COM2	
RS-422				CN3	COM1 COM3	Wiring diagram 3 - COM1 Wiring diagram 3 - COM3	
MP920 MP930		Memobus port on the CPU module		RS-232C	COM2	Wiring diagram 1 - COM2	
		217IF	CN1 CN2	RS-232C	COM2	Wiring diagram 1 - COM2	
			CN3	RS-422	COM1 COM3	Wiring diagram 4 - COM1 Wiring diagram 4 - COM3	
MP2200 MP2300 MP2300S		217IF-01 218IF-01	PORT	RS-232C	COM2	Wiring diagram 4 - COM2	
		217IF-01	RS422/485	RS-422	COM1 COM3	Wiring diagram 5 - COM1 Wiring diagram 5 - COM3	
MP2000 series		MP2200 MP2300 MP2300S	217IF-01 218IF-01 218IF-02 260IF-01 261IF-01 215AIF-01	PORT	RS-232C	COM2	Wiring diagram 4 - COM2
			217IF-01	RS422/485	RS-422	COM1 COM3	Wiring diagram 5 - COM1 Wiring diagram 5 - COM3

*1 For the ladder transfer function, see "Appendix 5 Ladder Transfer Function".

Ethernet Connection

PLC Selection on the Editor	CPU	Unit	TCP/IP	UDP/IP	Port No.	Ladder Transfer ^{*1}
MP2300 (MODBUS TCP/IP)	MP2300S MP2400	218IFA (built-in LAN port)	○	×	Set the desired number using the tool.	×
	MP2200 MP2300 MP2300S	218IF-01				
CP/MP Expansion Memobus (UDP/IP)	MP2300S MP2400	218IFA (built-in LAN port)	×	○		
	MP2200 MP2300 MP2300S	218IF-01				
MP2000 series (UDP/IP)	MP2200 (CPU-03) MP2310 MP2300S MP2400	218IFA (Built-in LAN port)	×	○	Default 9999	×
	MP2200 (CPU-04)	218IFC (Built-in LAN port)			Default 10000	
	MP2200 (CPU-01/02/03/04) MP2300 MP2310 MP2300S	218IF-01 218IF-02 263IF-01			Default 9999	

*1 For the ladder transfer function, see "Appendix 5 Ladder Transfer Function".

55.1.1 Memobus

Communication Setting

Editor

Communication setting

(Underlined setting: default)

Item	Setting	Remarks
Connection Mode	<u>1:1</u> / 1 : n / Multi-link2	
Signal Level	<u>RS-232C</u> / RS-422/485	
Baud Rate	4800 / 9600 / <u>19200</u> bps	
Data Length	8 bits	
Stop Bit	<u>1</u> / 2 bits	
Parity	None / Odd / <u>Even</u>	
Target Port No.	<u>1</u> to 31	
Transmission Mode	<u>Type 1</u> / Type 2	For GL60 series or PROGIC-8: Type 1: special binary code For GL120/130 series: Type 2: standard binary code

PLC

Be sure to match the settings to those made on the [Communication Settings] tab window of the editor. For more information, refer to the PLC manual issued by the manufacturer.

Item	Setting	Remarks
Signal Level	RS-232C / RS-422	
Baud Rate	4800 / 9600 / 19200 bps	
Data Length	8 bits	RTU mode
Stop Bit	1 bit	
Parity	Even	
Station No.	1 to 31	
Error Check	CRC	
Port Delay Timer	0	

Available Memory

The available memory setting range varies depending on the PLC model. Be sure to set within the range available with the PLC to be used. Use [TYPE] when assigning the indirect memory for macro programs.

Memory	TYPE	Remarks
4 (holding register)	00H	
3 (input register)	01H	Including constant register, read only
R (link register)	02H	
A (extension register)	03H	
0 (coil)	04H	
D (link coil)	05H	
1 (input relay)	06H	Read only
7 (constant register)	07H	

55.1.2 CP9200SH/MP900

Communication Setting

Editor

Communication setting

(Underlined setting: default)

Item	Setting	Remarks
Connection Mode	<u>1</u> : 1 / 1 : n / Multi-link2	
Signal Level	<u>RS-232C</u> / RS-422/485	
Baud Rate	4800 / 9600 / <u>19200</u> / 38400 / 57600 / 76800 bps	
Data Length	8 bits	
Stop Bit	<u>1</u> / 2 bits	
Parity	None / Odd / <u>Even</u>	
Target Port No.	<u>1</u> to 31	

PLC

CP-217IF

Be sure to match the settings to those made on the [Communication Settings] tab window of the editor.
For more information on communication settings, refer to the PLC manual issued by the manufacturer.

Memobus Port on the CPU Module (MP920, MP930) / 217IF

Module configuration

Item	Setting	Remarks
Transmission Protocol	Memobus	
Master/Slave	Slave	
Device Address	1 to 31	
Serial I/F	RS-232	
Transmission Mode	RTU	
Data Length	8 bits	
Parity Bit	Even	
Stop Bit	1 stop	
Baud Rate	19.2K	For connection via RS-422 on "217IF", 76800 bps can also be selected. For more information, refer to the PLC manual issued by the manufacturer.

217IF-01, 218IF-01**Module configuration**

Item	Setting	Remarks
Transmission Protocol	Memobus	
Master/Slave	Slave	
Device Address	1	
Serial I/F	RS-232 / RS-485	
Transmission Mode	RTU	
Data Length	8 bits	
Parity Bit	Even	
Stop Bit	1 stop	
Baud Rate	19.2K	The maximum baud rate available is 76.8 kbps.
Automatic Reception	Specified / Not Specified	To speed up communications, select [Not Specified]. When [Not Specified] is selected, the MSG-RCV function is required. For more information, refer to the PLC manual issued by the manufacturer.
Automatic Reception Setting	As desired	Make the setting when [Specified] is selected for [Automatic Reception].

Available Memory

The available memory setting range varies depending on the PLC model. Be sure to set within the range available with the PLC to be used. Use [TYPE] when assigning the indirect memory for macro programs.

Memory	TYPE	Remarks
MW (holding register)	00H	MB as bit device
IW (input register)	01H	IB as bit device, read only
MB (coil)	04H	MW as word device
IB (input relay)	06H	IW as word device, read only

When setting the MB/IB memory, set the bit numbers in the hexadecimal notation.

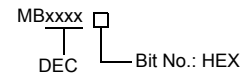

55.1.3 MP2300 (MODBUS TCP/IP)

Communication Setting

Editor

Make the following settings on the editor. For more information, see “Appendix 2 Ethernet”.

- IP address for the TS unit
- TS unit's port number in the [Communication Setting] tab window ([System Setting] → [Device Connection Setting])
- PLC's IP address and port number for [PLC Table] in the [Target Settings] tab window ([System Setting] → [Device Connection Setting])

PLC

218IFA (Built-in LAN Port)

Module configuration

Item	Setting	Remarks
IP Address	Set the IP address of “218IFA”.	
Subnet Mask	Set the subnet mask of “218IFA”.	
Local Port	256 to 65535	Cannot set the same number as the one set for another connection number.
Target IP Address	000.000.000.000	Connected in the “Unpassive open” mode *
Target Port	0000	
Connection Type	TCP	
Protocol Type	MODBUS TCP/IP	
Code	BIN	
Automatic Reception	Valid	When “Valid” is checked, the operation equivalent to the MSG-RCV function is automatically performed.

* Gives a response to the connection request issued by the station whose address is within the range specified by the subnet mask regardless of its IP address setting.

218IF-01 (MP2200, MP2300)

Make the settings as shown below and create a program of the MSG-RCV function. For more information, refer to the PLC manual issued by the manufacturer.

Module configuration

Item	Setting	Remarks
IP Address	Set the IP address of “218IF-01”.	
Local Port	256 to 65534	Cannot set the same number as the one set for another connection number.
Target IP Address	000.000.000.000	Connected in the “Unpassive open” mode *
Target Port	0000	
Connection Type	TCP	
Protocol Type	MODBUS TCP/IP	
Code	BIN	

* Gives a response to the connection request issued by the station whose address is within the range specified by the subnet mask regardless of its IP address setting.

Available Memory

The available memory setting range varies depending on the PLC model. Be sure to set within the range available with the PLC to be used. Use [TYPE] when assigning the indirect memory for macro programs.

Memory	TYPE	Remarks
MW (holding register)	00H	MB as bit device
IW (input register)	01H	IB as bit device, read only
MB (coil)	04H	MW as word device
IB (input relay)	06H	IW as word device, read only

When setting the MB/IB memory, set the bit numbers in the hexadecimal notation.

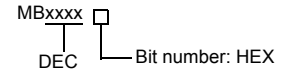

55.1.4 CP/MP Expansion Memobus (UDP/IP)

Communication Setting

Editor

Make the following settings on the editor. For more information, see “Appendix 2 Ethernet”.

- IP address for the TS unit
- TS unit's port number in the [Communication Setting] tab window ([System Setting] → [Device Connection Setting])
- PLC's IP address and port number for [PLC Table] in the [Target Settings] tab window ([System Setting] → [Device Connection Setting])

PLC

218IFA (Built-in LAN Port)

Module configuration

Item	Setting	Remarks
IP Address	Set the IP address of “218IFA”.	
Subnet Mask	Set the subnet mask of “218IFA”.	
Local Port	256 to 65535	Except 9998 and 10000. Cannot set the same number as the one set for another connection number.
Target IP Address	Set the IP address of the TS series.	
Target Port	Set the port number of the TS series.	
Connection Type	UDP	
Protocol Type	Extension Memobus	
Code	BIN	
Automatic Reception	Valid	When “Valid” is checked, the operation equivalent to the MSG-RCV function is automatically performed.

218IF-01

Make the settings as shown below and create a program of the MSG-RCV function. For more information, refer to the PLC manual issued by the manufacturer.

Module configuration

Item	Setting	Remarks
IP Address	Set the IP address of “218IF-01”.	
Local Port	255 to 65535	Cannot set the same number as the one set for another connection number.
Target IP Address	Set the IP address of the TS series.	
Target Port	Set the port number of the TS series.	
Connection Type	UDP	
Protocol Type	Extension Memobus	
Code	BIN	

Available Memory

The available memory setting range varies depending on the PLC model. Be sure to set within the range available with the PLC to be used. Use [TYPE] when assigning the indirect memory for macro programs.

Memory	TYPE	Remarks
MW (holding register)	00H	MB as bit device
IW (input register)	01H	IB as bit device, read only
MB (coil)	04H	MW as word device
IB (input relay)	06H	IW as word device, read only

When setting the MB/IB memory, set the bit numbers in the hexadecimal notation.

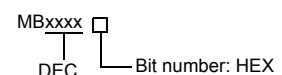

55.1.5 MP2000 Series

Communication Setting

Editor

Communication setting

(Underlined setting: default)

Item	Setting	Remarks
Connection Mode	<u>1</u> : 1 / 1 : n / Multi-link2 / Multi-link2 (Ethernet) / 1 : n Multi-link2 (Ethernet)	
Signal Level	<u>RS-232C</u> / RS-422/485	
Baud Rate	4800 / 9600 / <u>19200</u> / 38400 / 57600 / 76800 bps	
Data Length	8 bits	
Stop Bit	<u>1</u> / 2 bits	
Parity	None / Odd / <u>Even</u>	
Target Port No.	<u>1</u> to 31	

PLC

217IF-01, 218IF-01, 218IF-02, 260IF-01, 261IF-01, 215AIF-01

Module configuration

Item	Setting	Remarks
Transmission Protocol	Memobus	
Master/Slave	Slave	
Device Address	1	
Serial I/F	RS-232/RS-485	
Transmission Mode	RTU	
Data Length	8Bit	
Parity Bit	even	
Stop Bit	1Stop	
Baud Rate	19.2K	The maximum baud rate available is 76.8 kbps.

Available Memory

The available memory setting range varies depending on the PLC model. Be sure to set within the range available for the PLC. Use [TYPE] when assigning the indirect memory for macro programs.

Memory	TYPE	Remarks
MW (holding register)	00H	MB as bit device
IW (input register)	01H	IB as bit device
MB (coil)	04H	MW as word device *1
IB (input relay)	06H	IW as word device
SW (system register)	08H	SB as bit device
SB (system)	09H	SW as word device *1
OW (output register)	0AH	OB as bit device
OB (output)	0BH	OW as word device

*1 When setting the MB/SB memory, set the bit numbers in the hexadecimal notation.

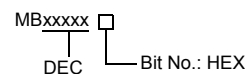

55.1.6 MP2000 Series (UDP/IP)

Communication Setting

Editor

Make the following settings on the editor. For more information, see “Appendix 2 Ethernet”.

- IP address for the TS unit
 - When specified on the screen data:
[System Setting] → [Ethernet Communication] → [Local Port IP Address]
 - When specified on the TS unit
Main Menu screen → [Ethernet]
- Port number for the TS unit (for communication with PLC)
[System Setting] → [Device Connection Setting] → [Communication Setting]
- IP address and port number of the PLC
[System Setting] → [Device Connection Setting] → [PLC Table]

PLC

Module configuration

Item	Setting	Remarks
IP Address	Set the IP address.	
Subnet Mask	Set the subnet mask.	
System Port (engineering port)	256 to 65535	Default 9999: 218IFA / 218IF-02 / 2613IF-01 10000: 218IF-01

Available Memory

The available memory setting range varies depending on the PLC model. Be sure to set within the range available for the PLC. Use [TYPE] when assigning the indirect memory for macro programs.

Memory	TYPE	Remarks
MW (holding register)	00H	MB as bit device
IW (input register)	01H	IB as bit device
MB (coil)	04H	MW as word device *1
IB (input relay)	06H	IW as word device
SW (system register)	08H	SB as bit device
SB (system)	09H	SW as word device *1
OW (output register)	0AH	OB as bit device
OB (output)	0BH	OW as word device

*1 When setting the MB/SB memory, set the bit numbers in the hexadecimal notation.

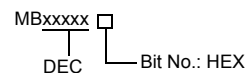

55.1.7 Wiring Diagrams

When Connected at COM1:

RS-422

Wiring diagram 1 - COM1

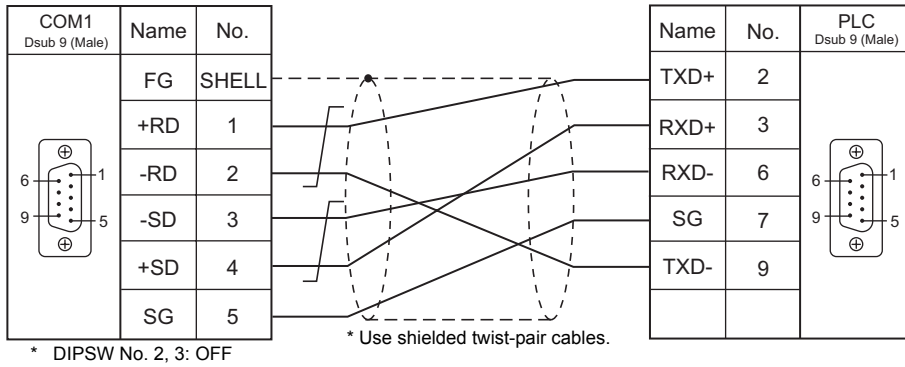

Wiring diagram 2 - COM1

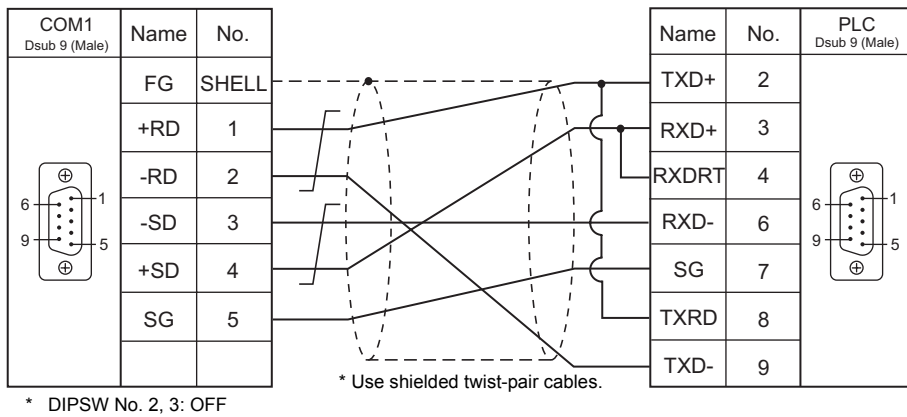

Wiring diagram 3 - COM1

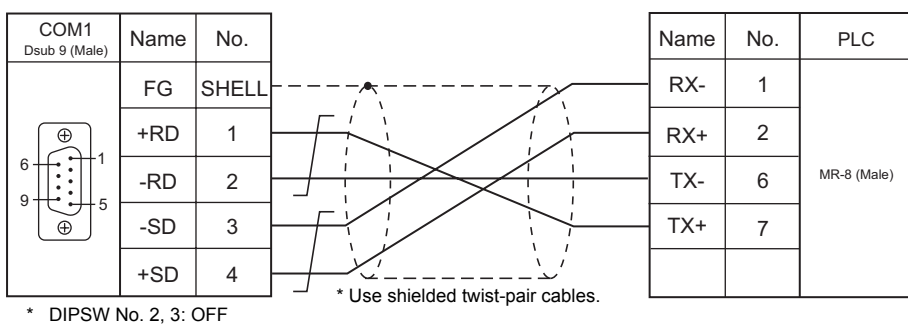

Wiring diagram 4 - COM1

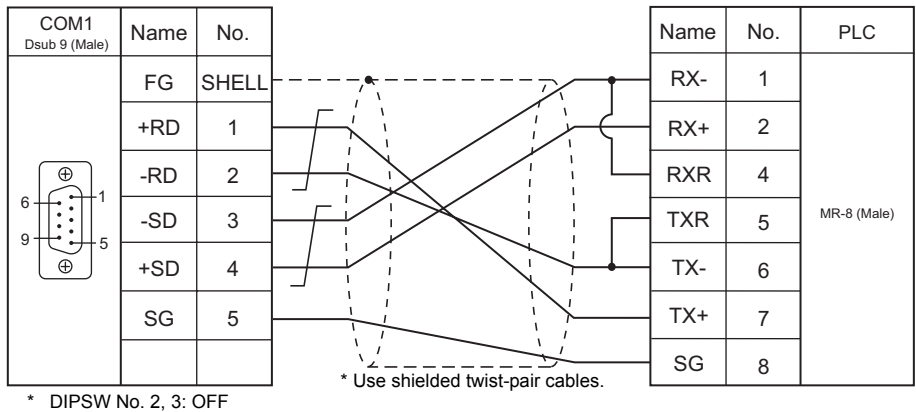

Wiring diagram 5 - COM1

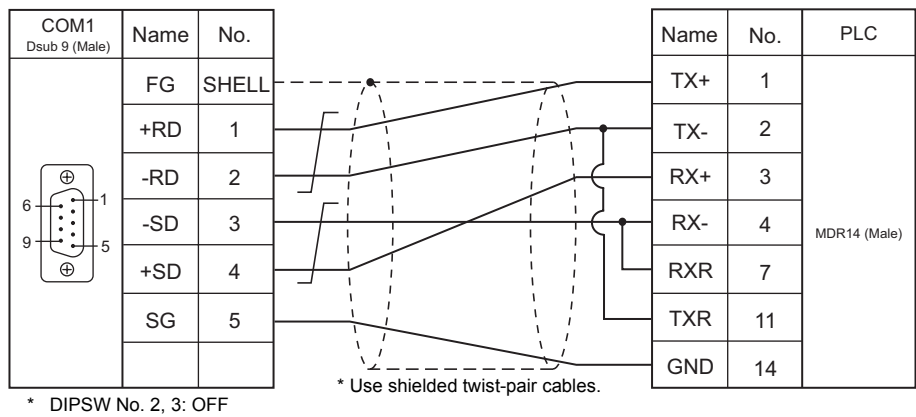

When Connected at COM2:

RS-232C

Wiring diagram 1 - COM2

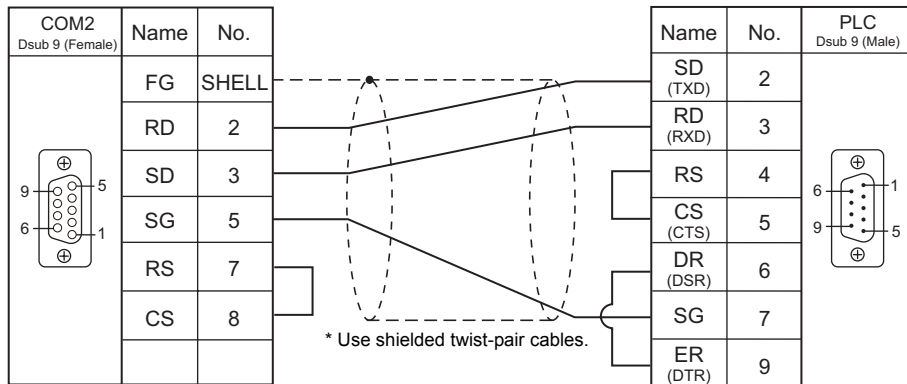

Wiring diagram 2 - COM2

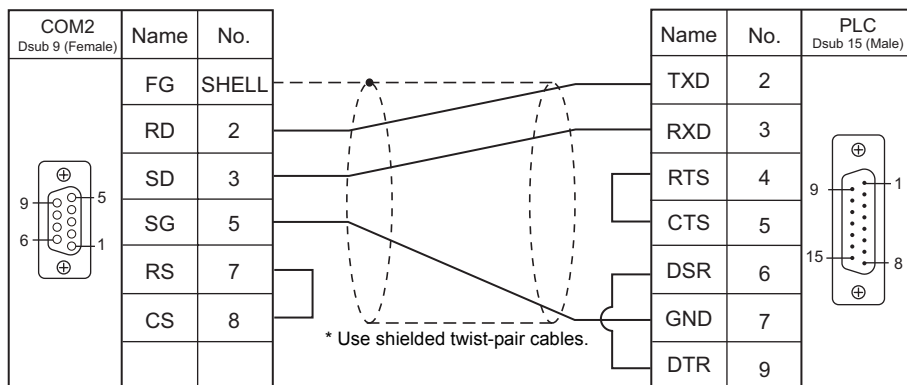

Wiring diagram 3 - COM2

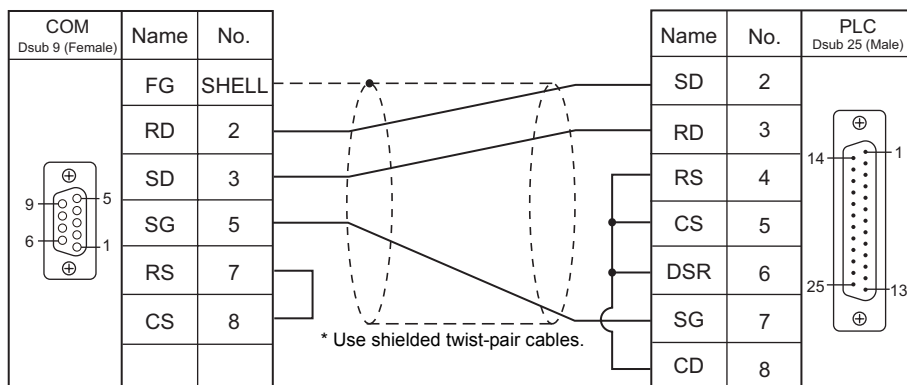

Wiring diagram 4 - COM2

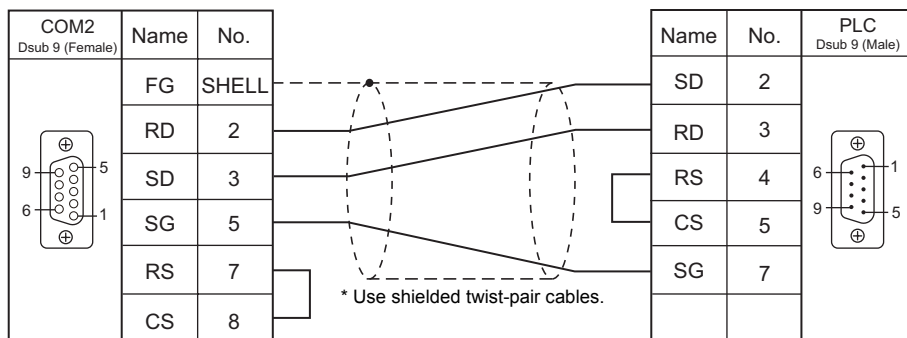

When Connected at COM3:

RS-485

Wiring diagram 1 - COM3

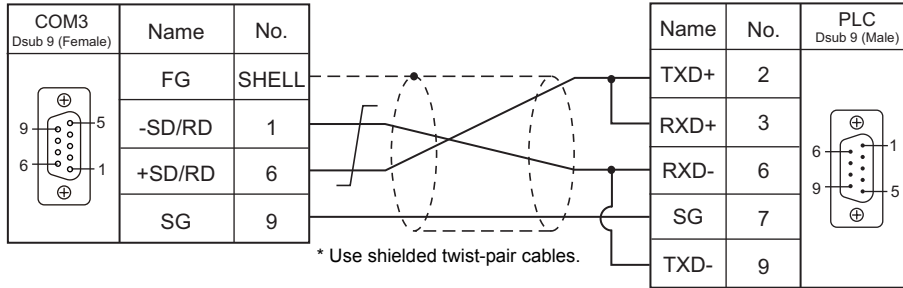

Wiring diagram 2 - COM3

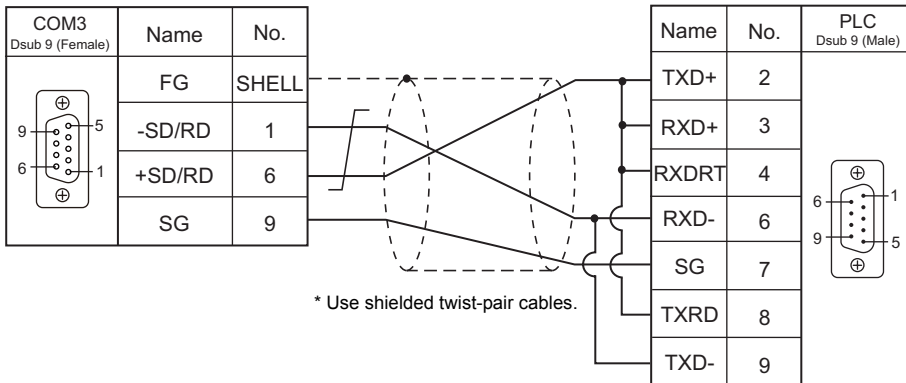

Wiring diagram 3 - COM3

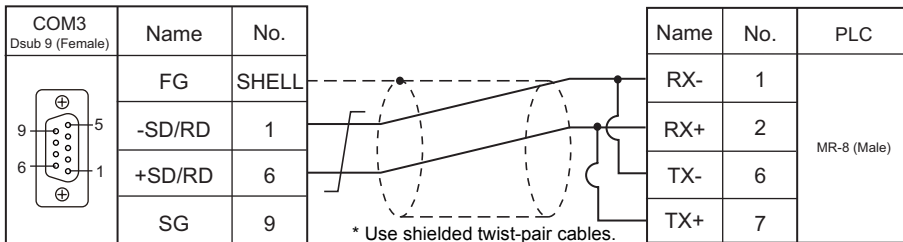

Wiring diagram 4 - COM3

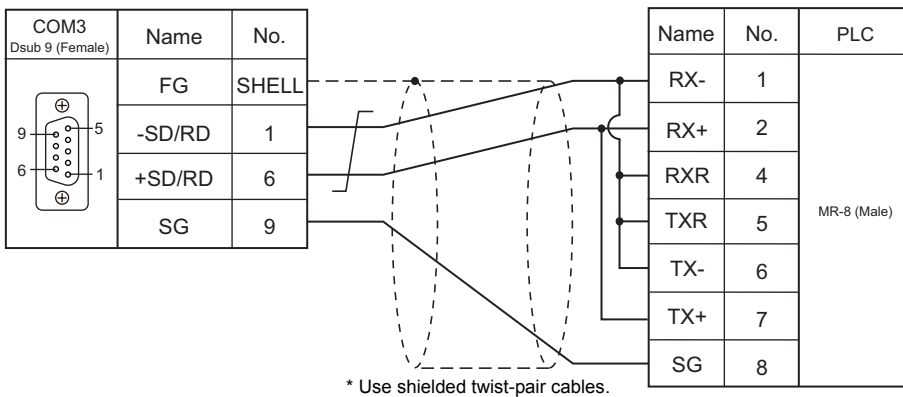

Wiring diagram 5 - COM3

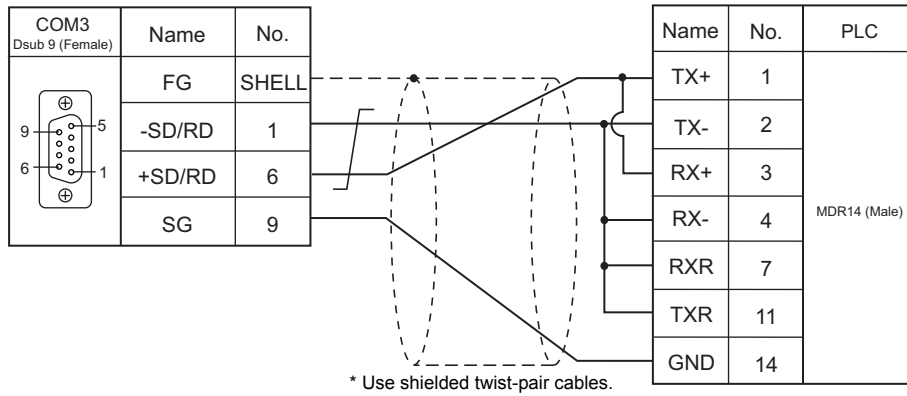

MEMO

Please use this page freely.

56. Yokogawa Electric

56.1 PLC Connection

56.2 Temperature Controller/Servo/Inverter Connection

56.1 PLC Connection

Serial Connection

PLC Selection on the Editor	CPU	Unit/Port	Signal Level	TS Port	Connection	Ladder Transfer ^{*2}
FA-M3	F3SP21-0N F3SP25-2N F3SP35-5N	PROGRAMMER port	RS-232C	COM2	Yokogawa "KM11-xT" + Wiring diagram 2 - COM2	○
	F3SP20-0N F3SP21-0N F3SP25-2N F3SP35-5N	F3LC01-1N ^{*1}	RS-232C	COM2	Wiring diagram 1 - COM2	×
		F3LC11-1N			Hakko Electronics "D9-YO2-09" ^{*3} + Gender changer	
		F3LC11-2N	RS-422	COM1	Wiring diagram 1 - COM1	
		COM3	Hakko Electronics "D9-YO4-0T" ^{*4} Wiring diagram 1 - COM3			
FA-M3R	F3SP28-3N/3S F3SP38-6N/6S F3SP53-4H/4S F3SP58-6H/6S F3SP59-7S	PROGRAMMER port	RS-232C	COM2	Yokogawa "KM11-xT" + Wiring diagram 2 - COM2	○
	F3SP28-3N/3S F3SP38-6N/6S F3SP53-4H/4S F3SP58-6H/6S F3SP59-7S F3SP66-4S F3SP67-6S F3SP71-4N F3SP76-7N	F3LC11-1N F3LC11-1F F3LC12-1F	RS-232C	COM2	Wiring diagram 1 - COM2	×
		F3LC11-2N F3LC11-2F	RS-422	COM1	Hakko Electronics "D9-YO2-09" ^{*3} + Gender changer	
					Wiring diagram 1 - COM1	
				COM3	Hakko Electronics "D9-YO4-0T" ^{*4} Wiring diagram 1 - COM3	
F3SP66-4S F3SP67-6S	SIO port	RS-232C	COM2	Yokogawa "KM21-2T" + Wiring diagram 2 - COM2	×	

*1 When the link unit "F3LC01-1N" is used, the communication setting and available memory are the same as those for "FA-500". However, "B" (common register) cannot be used.

*2 For the ladder transfer function, see "Appendix 5 Ladder Transfer Function".

*3 Cable length: D9-YO2-09-□ M (□ = 2, 3, 5)

*4 Cable length: D9-YO4-0T-□ M (□ = 2, 15)

Ethernet Connection

PLC Selection on the Editor	CPU	Unit/Port	TCP/IP	UDP/IP	Port No.	Keep Alive ^{*1}	Ladder Transfer ^{*2}
FA-M3/FA-M3R (Ethernet UDP/IP)	FA-M3/FA-M3R	F3LE01-5T	×	○	12289	○	×
		F3LE11-0T F3LE12-0T			12289 12291		
F3SP66-4S F3SP67-6S F3SP71-4N F3SP76-7N	T/TX	12289 12291					
F3LE01-5T	12289						
FA-M3/FA-M3R (Ethernet UDP/IP ASCII)	FA-M3/FA-M3R	F3LE11-0T F3LE12-0T	○	×	12289 12291	○	×
		F3LE01-5T			12289		
F3SP66-4S F3SP67-6S F3SP71-4N F3SP76-7N	T/TX	12289 12291					
F3LE11-0T F3LE12-0T	12289						
FA-M3/FA-M3R (Ethernet TCP/IP)	FA-M3/FA-M3R	F3LE01-5T	○	×	12289	○	×
		F3LE11-0T F3LE12-0T			12289 12291		
F3SP66-4S F3SP67-6S F3SP71-4N F3SP76-7N	T/TX	12289 12291					
F3LE11-0T F3LE12-0T	12289						
FA-M3/FA-M3R (Ethernet TCP/IP ASCII)	FA-M3/FA-M3R	F3LE01-5T	○	×	12289	○	×
		F3LE11-0T F3LE12-0T			12289 12291		
F3SP66-4S F3SP67-6S F3SP71-4N F3SP76-7N	T/TX	12289 12291					
F3LE11-0T F3LE12-0T	12289						

*1 For KeepAlive functions, see "Appendix 2 Ethernet".

*2 For the ladder transfer function, see "Appendix 5 Ladder Transfer Function".

56.1.1 FA-M3/FA-M3R

Communication Setting

Editor

Communication setting

(Underlined setting: default)

Item	Setting	Remarks
Connection Mode	<u>1:1</u> / 1:n / Multi-link / Multi-link2	
Signal Level	<u>RS-232C</u> / RS-422/485	
Baud Rate	4800 / 9600 / 19200 / 38400 / 57600 / 76800 / <u>115K</u> bps	
Data Length	7 / <u>8</u> bits	
Stop Bit	<u>1</u> / 2 bits	
Parity	<u>None</u> / Odd / Even	
Target Port No.	<u>0</u> to 31	
Transmission Mode	With Sum Check / <u>Without Sum Check</u>	

PLC

CPU Programmer Port / SIO Port

Item	Programmer port	SIO Port
Communication Mode	<u>9600 bps, even parity</u> 9600 bps, no parity 19200 bps, even parity 19200 bps, no parity 38400 bps, even parity 38400 bps, no parity 57600 bps, even parity 57600 bps, no parity 115200 bps, even parity 115200 bps, no parity	9600 bps, even parity 9600 bps, no parity 19200 bps, even parity 19200 bps, no parity 38400 bps, even parity 38400 bps, no parity 57600 bps, even parity 57600 bps, no parity <u>115200 bps, even parity</u> 115200 bps, no parity
PC Link Function	Use	
Sum check	Provided / <u>Not provided</u>	
Terminal Character	None	
Protection Function	None	
Data Length	8	

PC Link Module

Station number setting

(Underlined setting: default)

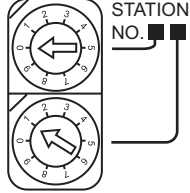
Station Number Setting	Setting	Setting Example
	<u>01</u> to 32	01

Baud rate setting switch

F3LC01-1N / F3LC11-1N / F3LC11-2N

(Underlined setting: default)

Baud Rate Setting Switch	Setting	Baud Rate	Remarks
	4	4800 bps	
	<u>5</u>	<u>9600 bps</u>	
	6	19200 bps	

F3LC11-1F / F3LC12-1F / F3LC11-2F

(Underlined setting: default)

Baud Rate Setting Switch	Setting	Baud Rate	Remarks
	4	4800 bps	
	5	9600 bps	
	7	19200 bps	
	9	38400 bps	
	A	57.6 kbps	
	B	76.8 kbps	
	<u>C</u>	<u>115.2 kbps</u>	

Data format setting switch

(Underlined setting: default)

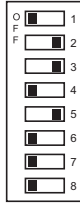
Switch	Functions	OFF	ON	Setting Example
1	Data length	7	<u>8</u>	
2	Parity	<u>Not provided</u>	Provided	
3		<u>Odd</u>	Even	
4	Stop bit	<u>1</u>	2	
5	Sum check	<u>Not provided</u>	Provided	
6	Terminal character	<u>Not provided</u>	Provided	
7	Protection function	<u>Not provided</u>	Provided	
8	-	-	-	

Function setting switch

All OFF

Available Memory

The available memory setting range varies depending on the PLC model. Be sure to set within the range available with the PLC to be used. Use [TYPE] when assigning the indirect memory for macro programs.

Memory	TYPE	Remarks
D (data register)	00H	
R (common register)	01H	
V (index register)	02H	
W (link register)	03H	
Z (special register)	04H	
TP (count-down timer/current value)	05H	
TS (timer/set value)	06H	Read only
CP (count-down counter/current value)	07H	
CS (counter/set value)	08H	Read only
X (input relay)	09H	
Y (output relay)	0AH	
I (internal relay)	0BH	
E (common relay)	0CH	
L (link relay)	0DH	
M (special relay)	0EH	
B (file register)	0FH	
SW (special module register)	10H	
SL (special module register)	11H	Double-word
F (cache register)	12H	Available only with F3SP71-4N and F3SP76-7N CPU.

* The CPU number is required in addition to the memory type and address. The assigned memory is indicated when editing the screen as shown on the right.

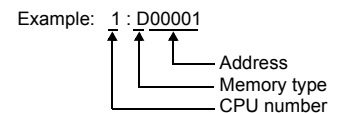

SW/SL memory

The SW or SL memory is used to read/write data from/into the data position number of the specified special module. For more information, refer to the PLC manual issued by the manufacturer. The address denotation of the SW or SL memory is shown below.

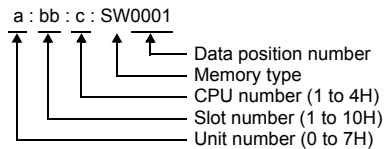

Indirect Memory Designation

- For X/Y memory

	15	8 7	0
n + 0	Model		Memory type
n + 1	Address No.		
n + 2	Expansion code *		Bit designation
n + 3	00		Station number

* For the expansion code, specify the value obtained by subtracting "1" from the actual CPU number.

Example: When specifying "X935" by indirect memory designation



Converting "A" into a binary number
9 (DEC) = 1001 (BIN)

09	08	07	06	05	04	03	02	01	00
0	0	0	0	0	0	1	0	0	1



Converting "BB" into a binary number
35 (DEC) = 100011 (BIN)

07	06	05	04	03	02	01	00
0	0	1	0	0	0	1	1

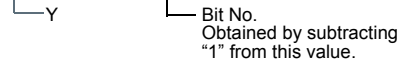

Arranging the values X, Y and Z in the following order

15	14	13	12	11	10	09	08	07	06	05	04	03	02	01	00
0	0	0	0	1	0	0	1	0	0	0	0	0	0	1	0



0000100100000010 (BIN) = 902 (HEX): Address No.
0011 (BIN) = 3 (HEX) - 1 = 2 (HEX): Bit No.

Example: When specifying "X76705" by indirect memory designation

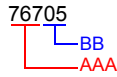

Converting "AAA" into a binary number
767 (DEC) = 1011111111 (BIN)

09	08	07	06	05	04	03	02	01	00
1	0	1	1	1	1	1	1	1	1



Converting "BB" into a binary number
05 (DEC) = 101 (BIN)

07	06	05	04	03	02	01	00
0	0	0	0	0	1	0	1

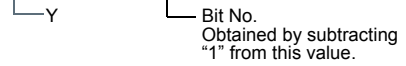

Arranging the values X, Y and Z in the following order

15	14	13	12	11	10	09	08	07	06	05	04	03	02	01	00
1	1	1	1	1	1	1	1	1	0	0	0	0	0	0	0



1111111100000000 (BIN) = FF80 (HEX): Address No.
0101 (BIN) = 5 (HEX) - 1 = 4 (HEX): Bit No.

• For SW/SL memory

	15		8	7		0
n + 0	Model				Memory type	
n + 1	Address No. *1					
n + 2	Unit number (0 to 7H)			Slot number (1 to 10H)		
n + 3	Expansion code *2			Bit designation		
n + 4	00			Station number		

*1 Specify the data position for the address number. The value to specify is obtained by subtracting "1" from the actual data position.

*2 Specify the expansion bit and the CPU number in the expansion code.

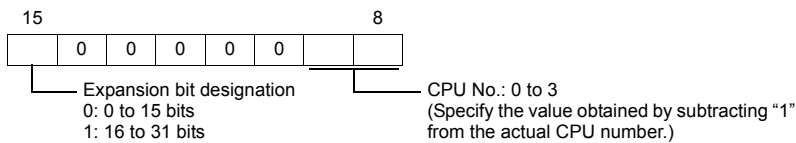

• Other than X/Y/SW/SL memory

For the memory address number, specify the value obtained by subtracting "1" from the actual memory address.
For the expansion code, specify the value obtained by subtracting "1" from the actual CPU number.

PLC_CTL

Macro command "PLC_CTL F0 F1 F2"

Contents	F0	F1 (= \$u n)		F2
User log registration number read	1 - 8 (PLC1 - 8)	n	CPU No. + station No. 	2
		n + 1	Command: FFFFH	
		n + 2	Registration number (Stores the same number as the one stored in special register Z105.)	
Latest user log read	1 - 8 (PLC1 - 8)	n	CPU No. + station No. 	2
		n + 1	Command: 0000H	
		n + 2	Header 0: Normal -1: Error (data not exist/communication error)	
		n + 3	Year (ASCII)	
		n + 4	Month (ASCII)	
		n + 5	Day (ASCII)	
		n + 6	Hour (ASCII)	
		n + 7	Minute (ASCII)	
		n + 8	Second (ASCII)	
		n + 9	Main code (DEC)	
		n + 10	Sub code (DEC)	
"n"th user log read	1 - 8 (PLC1 - 8)	n	CPU No. + station No. 	2
		n + 1	Command: 0001H to 003FH	
		n + 2	Header 0: Normal -1: Error (data not exist/communication error)	
		n + 3	Year (ASCII)	
		n + 4	Month (ASCII)	
		n + 5	Day (ASCII)	
		n + 6	Hour (ASCII)	
		n + 7	Minute (ASCII)	
		n + 8	Second (ASCII)	
		n + 9	Main code (DEC)	
		n + 10	Sub code (DEC)	

Contents	F0	F1 (= \$u n)	F2	
Latest system log read	1 - 8 (PLC1 - 8)	n	CPU No. + station No. CPU No. 1: 00 CPU No. 2: 01 CPU No. 3: 02 CPU No. 4: 03	2
		n + 1	Command: 0100H	
		n + 2	Error type 0: System error 1: Basic error 2: Sequence error 3: I/O error	
		n + 3	Error code	
		n + 4	Year (ASCII)	
		n + 5	Month (ASCII)	
		n + 6	Day (ASCII)	
		n + 7	Hour (ASCII)	
		n + 8	Minute (ASCII)	
		n + 9	Second (ASCII)	
		n + 10 -	Additional information (max. 11 words) *1	
"n"th system log read	1 - 8 (PLC1 - 8)	n	CPU No. + station No. CPU No. 1: 00 CPU No. 2: 01 CPU No. 3: 02 CPU No. 4: 03	2
		n + 1	Command: 0101H to 017FH	
		n + 2	Error type 0: System error 1: Basic error 2: Sequence error 3: I/O error	
		n + 3	Error code	
		n + 4	Year (ASCII)	
		n + 5	Month (ASCII)	
		n + 6	Day (ASCII)	
		n + 7	Hour (ASCII)	
		n + 8	Minute (ASCII)	
		n + 9	Second (ASCII)	
		n + 10 -	Additional information (max. 11 words) *1	
Alarm information clear	1 - 8 (PLC1 - 8)	n	CPU No. + station No. CPU No. 1: 00 CPU No. 2: 01 CPU No. 3: 02 CPU No. 4: 03	2
		n + 1	Command: FFFE H	

Contents	F0	F1 (= \$u n)		F2	
Mounted module name readout	1 - 8 (PLC1 - 8)	n	CPU No. + station No.  Station No.: 01 to 1F CPU No. CPU No. 1: 00 CPU No. 2: 01 CPU No. 3: 02 CPU No. 4: 03	3	
		n + 1	Command: FFFDH		
		n + 2	Unit No.: 0 to 7		
		n + 3 to n + 4	Module name (ASCII)		
		n + 5	Module information of slot 1 *2		I/O type (DEC) 0: Without I/O relay 1: Input relay only 2: Output relay only 3: With both input and output
		n + 6			Number of I/O relays (DEC)
		n + 7 to n + 8	Module information of slot 2 *2		Module name (ASCII)
		n + 9			I/O type (DEC) 0: Without I/O relay 1: Input relay only 2: Output relay only 3: With both input and output
		n + 10			Number of I/O relays (DEC)
		:	:		:
		n + 63 to n + 64	Module information of slot 16 *2		Module name (ASCII)
		n + 65			I/O type (DEC) 0: Without I/O relay 1: Input relay only 2: Output relay only 3: With both input and output
		n + 66			Number of I/O relays (DEC)

 Return data: Data stored from PLC to TS series

*1 Additional information (max. 11 words)

- For “system error”
No additional information
- For “basic error”

n + 10 to n + 13	Block name (8 bytes)
n + 14 to n + 16	Command number: 5-digit string pattern in decimal notation (5 bytes)

- For “sequence error”

n + 10 to n + 13	Program name (8 bytes)
n + 14 to n + 17	Subprogram name (8 bytes)
n + 18 to n + 20	Row number: 5 digits in decimal notation (5 bytes)

- For “I/O error”

n + 10 to n + 11	Slot number (4 bytes)
n + 12 to n + 13	Detailed error (4 bytes)

*2 When no module is mounted, “(space)” is assigned for the module name and “0” is assigned for the I/O type and the number of I/O relays.

56.1.2 FA-M3/FA-M3R (Ethernet UDP/IP)

Communication Setting

Editor

Make the following settings on the editor. For more information, see “Appendix 2 Ethernet”.

- IP address for the TS unit
- TS unit's port number in the [Communication Setting] tab window ([System Setting] → [Device Connection Setting])
- PLC's IP address and port number for [PLC Table] in the [Target Settings] tab window ([System Setting] → [Device Connection Setting])

PLC

Ethernet Module

Condition setting switch

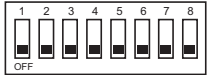
SW9	BIT	Contents	Setting															
	1	Data format setting	F3LE01-5T <table border="1" data-bbox="1029 855 1393 918"> <thead> <tr> <th>Port No.</th> <th>OFF</th> <th>ON</th> </tr> </thead> <tbody> <tr> <td>12289</td> <td>ASCII</td> <td>Binary</td> </tr> </tbody> </table> F3LE11-0T/F3LE12-0T <table border="1" data-bbox="1029 990 1393 1081"> <thead> <tr> <th>Port No.</th> <th>OFF</th> <th>ON</th> </tr> </thead> <tbody> <tr> <td>12289</td> <td>ASCII</td> <td>Binary</td> </tr> <tr> <td>12291</td> <td>Binary</td> <td>ASCII</td> </tr> </tbody> </table>	Port No.	OFF	ON	12289	ASCII	Binary	Port No.	OFF	ON	12289	ASCII	Binary	12291	Binary	ASCII
	Port No.	OFF	ON															
	12289	ASCII	Binary															
	Port No.	OFF	ON															
	12289	ASCII	Binary															
	12291	Binary	ASCII															
	2	Write protection	OFF: not protected															
	3	System reserved	OFF															
4																		
5																		
6																		
7	Line handling at TCP time-out ^{*1}	OFF: close																
8	Operation mode	OFF: normal																

*1 F3LE01-5T only

IP address setting switch

(Underlined setting: default)

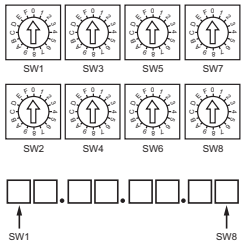
IP Address Setting Switch	Setting	Remarks
	<u>0.0.0.0</u> to 255.255.255.255	Set in hexadecimal notation. Example HEX C0.A8.FA.D2 ↓ DEC 192.168.250.210

SP66-4S / SP67-6S / SP71-4N / SP76-7N CPU

CPU properties

Setting	Setting Items	Setting	Remarks
NETWORK	NETWORK_SELECT	1	
ETHERNET	ETHER_MY_IPADDRESS	0.0.0.0 - 255.255.255.255	IP address
	ETHER_SUBNET_MASK	0.0.0.0 - 255.255.255.255	Subnet mask
HIGHER-LEVEL_LINK_SERVICE	HLLINK_PROTOCOL_A	1: UDP/IP	Port 12289
	HLLINK_DATA_FORMAT_A	1: binary code	
	HLLINK_PROTOCOL_B	1: UDP/IP	Port 12291
	HLLINK_DATA_FORMAT_B	1: binary code	
	HLLINK_PROTECT	0: write enabled	

Available Memory

The contents of "Available Memory" are the same as those described in "56.1.1 FA-M3/FA-M3R".

PLC_CTL

The contents of "PLC_CTL" are the same as those described in "56.1.1 FA-M3/FA-M3R".

* The station number can be specified in the range from 0 to FFH.

For the station number, specify the PLC table number set for [System Setting] → [Device Connection Setting] → [Target Settings].

56.1.3 FA-M3/FA-M3R (Ethernet UDP/IP ASCII)

Communication Setting

Editor

Make the following settings on the editor. For more information, see “Appendix 2 Ethernet”.

- IP address for the TS unit
- TS unit's port number in the [Communication Setting] tab window ([System Setting] → [Device Connection Setting])
- PLC's IP address and port number for [PLC Table] in the [Target Settings] tab window ([System Setting] → [Device Connection Setting])

PLC

Ethernet Module

Condition setting switch

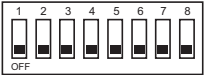
SW9	BIT	Contents	Setting															
	1	Data format setting	F3LE01-5T <table border="1" data-bbox="1059 855 1422 918"> <thead> <tr> <th>Port No.</th> <th>OFF</th> <th>ON</th> </tr> </thead> <tbody> <tr> <td>12289</td> <td>ASCII</td> <td>Binary</td> </tr> </tbody> </table> F3LE11-0T/F3LE12-0T <table border="1" data-bbox="1059 990 1422 1081"> <thead> <tr> <th>Port No.</th> <th>OFF</th> <th>ON</th> </tr> </thead> <tbody> <tr> <td>12289</td> <td>ASCII</td> <td>Binary</td> </tr> <tr> <td>12291</td> <td>Binary</td> <td>ASCII</td> </tr> </tbody> </table>	Port No.	OFF	ON	12289	ASCII	Binary	Port No.	OFF	ON	12289	ASCII	Binary	12291	Binary	ASCII
	Port No.	OFF	ON															
	12289	ASCII	Binary															
	Port No.	OFF	ON															
	12289	ASCII	Binary															
	12291	Binary	ASCII															
	2	Write protection	OFF: not protected															
	3	System reserved	OFF															
4																		
5																		
6																		
7	Line handling at TCP time-out*1	OFF: close																
8	Operation mode	OFF: normal																

*1 F3LE01-5T only

IP address setting switch

(Underlined setting: default)

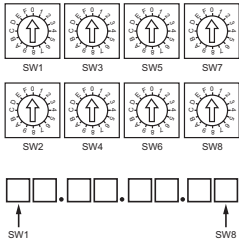
IP Address Setting Switch	Setting	Remarks
	<u>0.0.0.0</u> to 255.255.255.255	Set in hexadecimal notation. Example HEX C0.A8.FA.D2 ↓ DEC 192.168.250.210

SP66-4S / SP67-6S / SP71-4N / SP76-7N CPU**CPU properties**

Setting	Setting Items	Setting	Remarks
NETWORK	NETWORK_SELECT	1	
ETHERNET	ETHER_MY_IPADDRESS	0.0.0.0 to 255.255.255.255	IP address
	ETHER_SUBNET_MASK	0.0.0.0 to 255.255.255.255	Subnet mask
HIGHER-LEVEL_LINK_SERV ICE	HLLINK_PROTOCOL_A	1: UDP/IP	Port 12289
	HLLINK_DATA_FORMAT_A	0: ASCII format	
	HLLINK_PROTOCOL_B	1: UDP/IP	Port 12291
	HLLINK_DATA_FORMAT_B	0: ASCII format	
	HLLINK_PROTECT	0: write enabled	

Available Memory

The contents of "Available Memory" are the same as those described in "56.1.1 FA-M3/FA-M3R".

PLC_CTL

The contents of "PLC_CTL" are the same as those described in "56.1.1 FA-M3/FA-M3R".

* The station number can be specified in the range from 0 to FFH.

For the station number, specify the PLC table number set for [System Setting] → [Device Connection Setting] → [Target Settings].

56.1.4 FA-M3/FA-M3R (Ethernet TCP/IP)

Communication Setting

Editor

Make the following settings on the editor. For more information, see “Appendix 2 Ethernet”.

- IP address for the TS unit
- TS unit's port number in the [Communication Setting] tab window ([System Setting] → [Device Connection Setting])
- PLC's IP address and port number for [PLC Table] in the [Target Settings] tab window ([System Setting] → [Device Connection Setting])

PLC

Ethernet Module

Condition setting switch

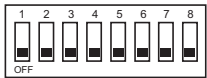
SW9	BIT	Contents	Setting															
	1	Data format setting	F3LE01-5T <table border="1"> <tr> <th>Port No.</th> <th>OFF</th> <th>ON</th> </tr> <tr> <td>12289</td> <td>ASCII</td> <td>Binary</td> </tr> </table> F3LE11-0T/F3LE12-0T <table border="1"> <tr> <th>Port No.</th> <th>OFF</th> <th>ON</th> </tr> <tr> <td>12289</td> <td>ASCII</td> <td>Binary</td> </tr> <tr> <td>12291</td> <td>Binary</td> <td>ASCII</td> </tr> </table>	Port No.	OFF	ON	12289	ASCII	Binary	Port No.	OFF	ON	12289	ASCII	Binary	12291	Binary	ASCII
	Port No.	OFF	ON															
	12289	ASCII	Binary															
	Port No.	OFF	ON															
	12289	ASCII	Binary															
	12291	Binary	ASCII															
	2	Write protection	OFF: not protected															
	3	System reserved	OFF															
4																		
5																		
6																		
7	Line handling at TCP time-out*1	OFF: close																
8	Operation mode	OFF: normal																

*1 F3LE01-5T only

*2 Port number: 12289

IP address setting switch

(Underlined setting: default)

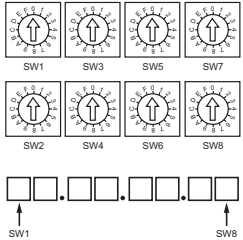
IP Address Setting Switch	Setting	Remarks
	<u>0.0.0.0</u> to 255.255.255.255	Set in hexadecimal notation. Example HEX C0.A8.FA.D2 ↓ DEC 192.168.250.210

SP66-4S / SP67-6S / SP71-4N / SP76-7N CPU**CPU properties**

Setting	Setting Items	Setting	Remarks
NETWORK	NETWORK_SELECT	1	
ETHERNET	ETHER_MY_IPADDRESS	0.0.0.0 - 255.255.255.255	IP address
	ETHER_SUBNET_MASK	0.0.0.0 - 255.255.255.255	Subnet mask
HIGHER-LEVEL_LINK_SERVICE	HLLINK_PROTOCOL_A	0: TCP/IP	Port 12289
	HLLINK_DATA_FORMAT_A	1: binary code	
	HLLINK_PROTOCOL_B	0: TCP/IP	Port 12291
	HLLINK_DATA_FORMAT_B	1: binary code	
	HLLINK_PROTECT	0: write enabled	

Available Memory

The contents of "Available Memory" are the same as those described in "56.1.1 FA-M3/FA-M3R".

PLC_CTL

The contents of "PLC_CTL" are the same as those described in "56.1.1 FA-M3/FA-M3R".

* The station number can be specified in the range from 0 to FFH.

For the station number, specify the PLC table number set for [System Setting] → [Device Connection Setting] → [Target Settings].

56.1.5 FA-M3/FA-M3R (Ethernet TCP/IP ASCII)

Communication Setting

Editor

Make the following settings on the editor. For more information, see "Appendix 2 Ethernet".

- IP address for the TS unit
- TS unit's port number in the [Communication Setting] tab window ([System Setting] → [Device Connection Setting])
- PLC's IP address and port number for [PLC Table] in the [Target Settings] tab window ([System Setting] → [Device Connection Setting])

PLC

Ethernet Module

Condition setting switch

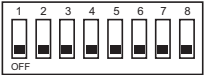
SW9	BIT	Contents	Setting															
	1	Data format setting	F3LE01-5T <table border="1" data-bbox="1059 855 1422 918"> <thead> <tr> <th>Port No.</th> <th>OFF</th> <th>ON</th> </tr> </thead> <tbody> <tr> <td>12289</td> <td>ASCII</td> <td>Binary</td> </tr> </tbody> </table> F3LE11-0T/F3LE12-0T <table border="1" data-bbox="1059 990 1422 1081"> <thead> <tr> <th>Port No.</th> <th>OFF</th> <th>ON</th> </tr> </thead> <tbody> <tr> <td>12289</td> <td>ASCII</td> <td>Binary</td> </tr> <tr> <td>12291</td> <td>Binary</td> <td>ASCII</td> </tr> </tbody> </table>	Port No.	OFF	ON	12289	ASCII	Binary	Port No.	OFF	ON	12289	ASCII	Binary	12291	Binary	ASCII
	Port No.	OFF	ON															
	12289	ASCII	Binary															
	Port No.	OFF	ON															
	12289	ASCII	Binary															
	12291	Binary	ASCII															
	2	Write protection	OFF: not protected															
	3	System reserved	OFF															
4																		
5																		
6																		
7	Line handling at TCP time-out*1	OFF: close																
8	Operation mode	OFF: normal																

*1 F3LE01-5T only

IP address setting switch

(Underlined setting: default)

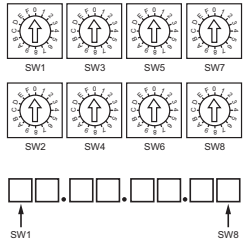
IP Address Setting Switch	Setting	Remarks
	<u>0.0.0.0</u> to 255.255.255.255	Set in hexadecimal notation. Example HEX C0.A8.FA.D2 ↓ DEC 192.168.250.210

SP66-4S / SP67-6S / SP71-4N / SP76-7N CPU

CPU properties

Setting	Setting Items	Setting	Remarks
NETWORK	NETWORK_SELECT	1	
ETHERNET	ETHER_MY_IPADDRESS	0.0.0.0 to 255.255.255.255	IP address
	ETHER_SUBNET_MASK	0.0.0.0 to 255.255.255.255	Subnet mask
HIGHER-LEVEL_LINK_SERVICE	HLLINK_PROTOCOL_A	0: TCP/IP	Port 12289
	HLLINK_DATA_FORMAT_A	0: ASCII format	
	HLLINK_PROTOCOL_B	0: TCP/IP	Port 12291
	HLLINK_DATA_FORMAT_B	0: ASCII format	
	HLLINK_PROTECT	0: write enabled	

Available Memory

The contents of "Available Memory" are the same as those described in "56.1.1 FA-M3/FA-M3R".

PLC_CTL

The contents of "PLC_CTL" are the same as those described in "56.1.1 FA-M3/FA-M3R".

* The station number can be specified in the range from 0 to FFH.

For the station number, specify the PLC table number set for [System Setting] → [Device Connection Setting] → [Target Settings].

56.1.6 Wiring Diagrams

When Connected at COM1:

RS-422

Wiring diagram 1 - COM1

Hakko Electronics' cable "D9-YO4-0T-□M" (□ = 2, 15)

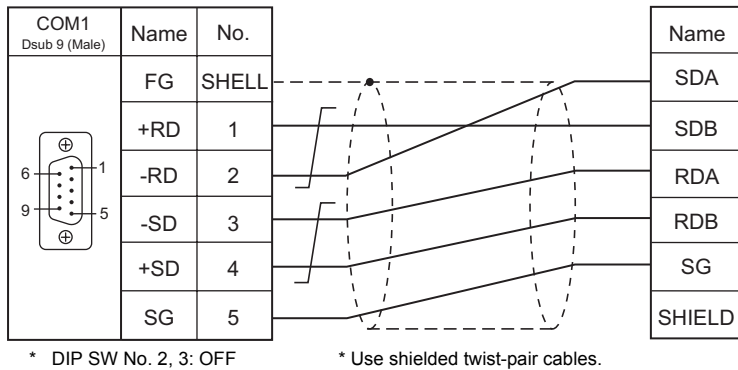

When Connected at COM2:

RS-232C

Wiring diagram 1 - COM2

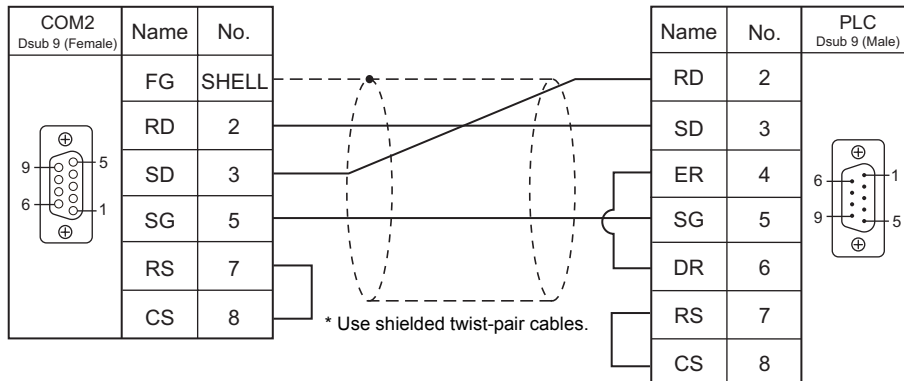

Wiring diagram 2 - COM2

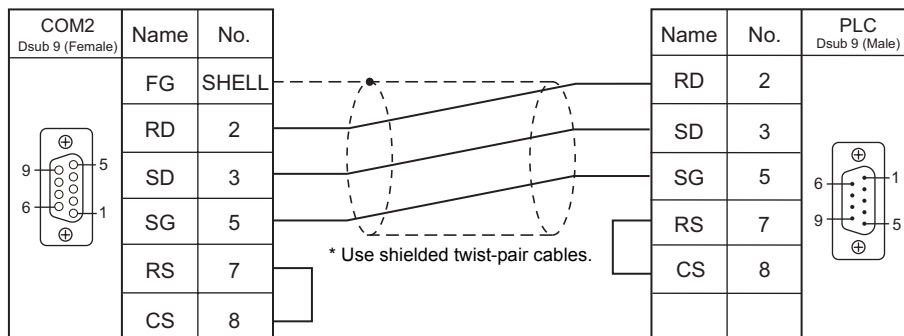

When Connected at COM3:

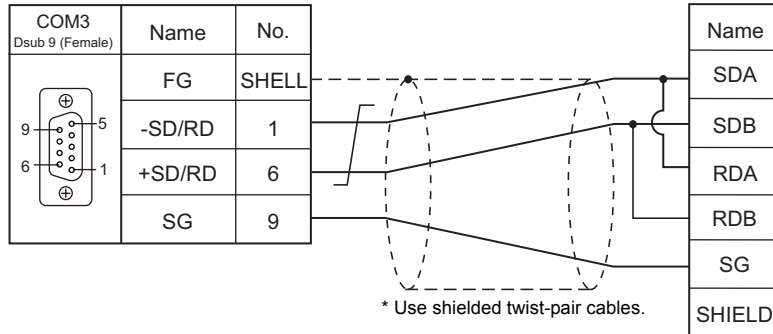
RS-485**Wiring diagram 1 - COM3**

56.2 Temperature Controller/Servo/Inverter Connection

Temperature Controller

PLC Selection on the Editor	Model	Port	Signal Level	TS Port	Connection	Lst File
UT100	UT130-xx/RS UT150-xx/RS UT152-xx/RS UT155-xx/RS	RS-485 port	RS-485	COM1	Wiring diagram 2 - COM1	UT100.Lst
				COM3	Wiring diagram 2 - COM3	

Digital Indicating Controller

PLC Selection on the Editor	Model	Port	Signal Level	TS Port	Connection	Lst File
UT750	UT750-01 UT750-11 UT750-51	RS-485 port	RS-485	COM1	Wiring diagram 1 - COM1	UT750.Lst
				COM3	Wiring diagram 1 - COM3	
		High-speed RS-485 port	RS-485	COM1	Wiring diagram 2 - COM1	
				COM3	Wiring diagram 2 - COM3	
UT550	UT550-01, 02 UT550-11, 12 UT550-21, 22 UT550-31, 32 UT550-41, 42	RS-485 port	RS-485	COM1	Wiring diagram 1 - COM1	UT550.Lst
UT520	UT520-07					
UT350	UT350-01 UT350-21 UT350-31					UT350.Lst
UT320	UT320-01 UT320-21 UT320-31	RS-485 port	RS-485	COM3	Wiring diagram 1 - COM3	UT450.Lst
UT450	UT450-01, 02 UT450-11, 12 UT450-21, 22 UT450-31, 32 UT450-41, 42					

Multi-point Temperature Controller

PLC Selection on the Editor	Model	Port	Signal Level	TS Port	Connection	Lst File
UT2400/2800	UT2400-1, 1/HB UT2400-2, 2/HB UT2400-3, 3/HB UT2400-4, 4/HB UT2800-1, 1/HB UT2800-2, 2/HB UT2800-3, 3/HB UT2800-4, 4/HB	RS-485 port	RS-422	COM1	Wiring diagram 3 - COM1	UT2000.Lst

56.2.1 UT100

Communication Setting

Editor

Communication setting

(Underlined setting: default)

Item	Setting	Remarks
Connection Mode	1 : 1 / <u>1:n</u> / Multi-link2	
Signal Level	<u>RS-422/485</u>	
Baud Rate	4800 / <u>9600</u> bps	
Data Length	7 / <u>8</u> bits	
Stop Bit	<u>1</u> / 2 bits	
Parity	None / Odd / <u>Even</u>	
Target Port No.	1 to 31	
Sum Check	Provided / <u>Not provided</u>	Make the same setting as PSL (communication protocol selection) of the temperature controller.

Temperature Controller

The communication parameters can be set using keys attached to the temperature controller. Be sure to match the settings to those made on the [Communication Setting] tab window of the editor.

(Underlined setting: default)

Parameter	Display	Item	Setting	Example
Communication	PSL	Protocol selection	<u>0</u> : PC link communication 1: PC link communication (with checksum)	0
	ADR	Communication address	1 to 31	1
	BPS	Baud rate	4.8: 4800 bps <u>9.6</u> : 9600 bps	9.6
	PRI	Parity	NON: None <u>EVN</u> : Even ODD: Odd	EVN
	STP	Stop bit	<u>1</u> / 2 bits	1
	DLN	Data length	7 / <u>8</u> bits	8

Available Memory

The available memory setting range varies depending on the models. Be sure to set within the range available for the device. Use [TYPE] when assigning the indirect memory for macro programs.

Memory	TYPE	Remarks
D (data register)	00H	
I (input relay)	01H	

Indirect Memory Designation

Specify the value subtracted "1" from the real memory address for the memory address No..

56.2.2 UT750

Communication Setting

Editor

Communication setting

(Underlined setting: default)

Item	Setting	Remarks
Connection Mode	1 : 1 / <u>1:n</u> / Multi-link2	
Signal Level	<u>RS-422/485</u>	
Baud Rate	4800 / <u>9600</u> / 19200 / 38400 bps	
Data Length	7 / <u>8</u> bits	
Stop Bit	<u>1</u> / 2 bits	
Parity	None / Odd / <u>Even</u>	
Target Port No.	<u>1</u> to 31	
Sum Check	Provided / <u>Not provided</u>	Make the same setting as PSL (communication protocol selection) of the temperature controller.

Digital Indicating Controller

The communication parameters can be set using keys attached to the digital indicating controller. Be sure to match the settings to those made on the [Communication Setting] tab window of the editor.

(Underlined setting: default)

Parameter	Port	Indication	Item	Setting	Example
Communication	RS-485 port	PSL1	Protocol selection 1	<u>0: Personal computer link communication</u> 1: Personal computer link communication (with sum check)	0
		BPS1	Baud rate 1	3: 4800 bps <u>4: 9600 bps</u>	4
		PRI1	Parity 1	0: None <u>1: Even</u> 2: Odd	1
		STP1	Stop bit 1	<u>1</u> / 2 bits	1
		DLN1	Data length 1	7 / <u>8</u> bits	8
		ADR1	Address 1	<u>1</u> to 31	1
	High-speed RS-485 port	PSL2	Protocol selection 2	<u>0: Personal computer link communication</u> 1: Personal computer link communication (with sum check)	0
		BPS2	Baud rate 2	3: 4800 bps <u>4: 9600 bps</u> 5: 19200 bps 6: 38400 bps	4
		PRI2	Parity 2	0: None <u>1: Even</u> 2: Odd	1
		STP2	Stop bit 2	<u>1</u> / 2 bits	1
		DLN2	Data length 2	7 / <u>8</u> bits	8
		ADR2	Address 2	<u>1</u> to 31	1

Available Memory

The available memory setting range varies depending on the models. Be sure to set within the range available for the device. Use [TYPE] when assigning the indirect memory for macro programs.

Memory	TYPE	Remarks
D (data register)	00H	
I (input relay)	01H	

Indirect Memory Designation

Specify the value subtracted "1" from the real memory address for the memory address No..

56.2.3 UT550

Settings are the same as those described in "56.2.1 UT100".

56.2.4 UT520

Settings are the same as those described in "56.2.1 UT100".

56.2.5 UT350

Settings are the same as those described in "56.2.1 UT100".

56.2.6 UT320

Settings are the same as those described in "56.2.1 UT100".

56.2.7 UT450

Settings are the same as those described in "56.2.1 UT100".

56.2.8 UT2400/2800

Communication Setting

Editor

Communication setting

(Underlined setting: default)

Item	Setting	Remarks
Connection Mode	1 : 1 / <u>1:n</u> / Multi-link2	
Signal Level	<u>RS-422/485</u>	
Baud Rate	4800 / <u>9600</u> bps	
Data Length	7 / <u>8</u> bits	
Stop Bit	<u>1</u> / 2 bits	
Parity	None / Odd / <u>Even</u>	
Target Port No.	<u>1</u> to 16	
CR	<u>Checked</u> / Unchecked	
CPU No. *	01 / 02	01: 1 to 4CH 02: 5 to 8CH (available only with UT2800)

* Set the CPU number on the [Memory Input] dialog.
"CPU No. 2" is not provided for UT2400. It can be specified only when UT2800 is used.

Multi-point Temperature Controller

Be sure to match the settings to those made on the [Communication Setting] tab window of the editor.

Communication mode selector switch

(Underlined setting: default)

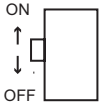
Communication Mode Selector Switch	OFF	ON	Remarks
	Ladder communication mode	<u>Personal computer link communication mode</u>	

Communication condition setting switch

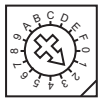
Communication Condition Setting Switch	Setting	Baud Rate	Parity	Data Length	Stop Bit	Setting Example
	0	9600 bps	None	8	1	2: 9600 bps Even 8 bits 1 bit
	1		Odd			
	2		Even			
	3	4800 bps	None			
	4		Odd			
	5		Even			

Unit No. selector switch

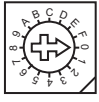
Unit No. Selector Switch	Setting	Station Number	Setting Example
	0 to F	1 to 16	0: Station number 1

Available Memory

The available memory setting range varies depending on the models. Be sure to set within the range available for the device. Use [TYPE] when assigning the indirect memory for macro programs.

Memory	TYPE	Remarks
D (data register)	00H	
I (input relay)	01H	

* The CPU number is required in addition to the memory type and address. The assigned memory is indicated when editing the screen as shown on the right.

Example: 1 : D00001

Address number
Memory type
CPU number

Indirect Memory Designation

Specify the value subtracted "1" from the real memory address for the memory address No.. Specify the CPU number in the expansion code.

56.2.9 Wiring Diagrams

When Connected at COM1:

RS-422/RS-485

Wiring diagram 1 - COM1

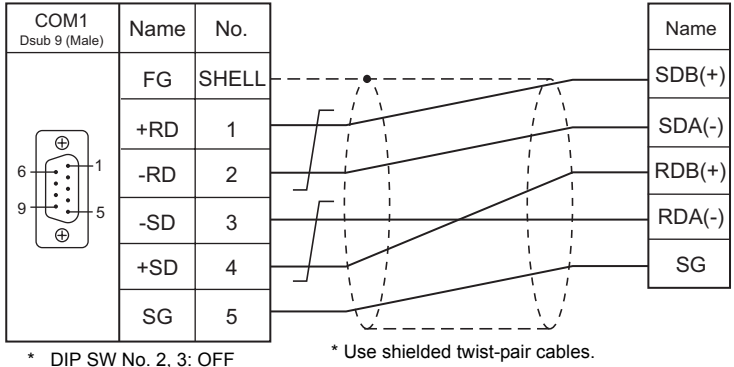

Wiring diagram 2 - COM1

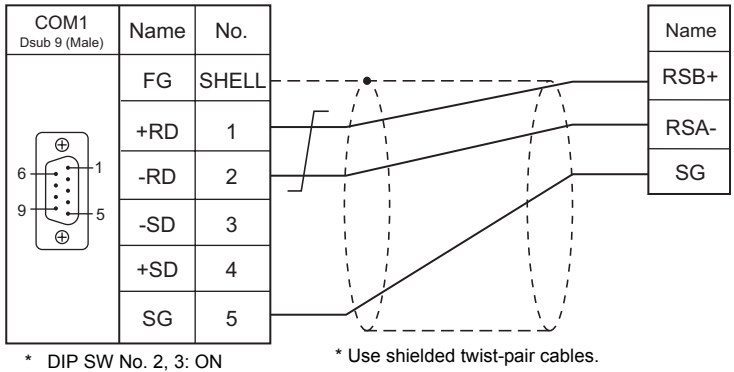

Wiring diagram 3 - COM1

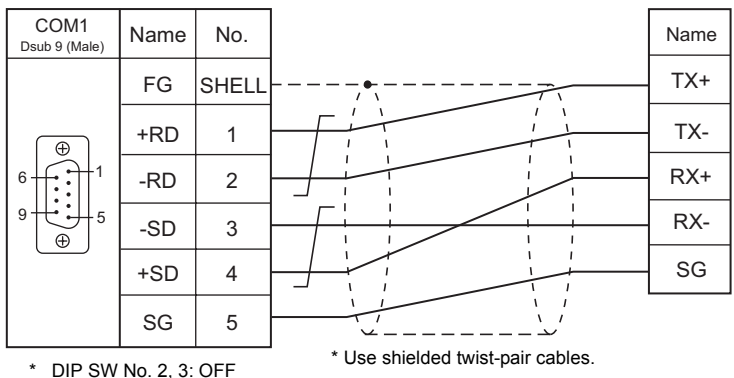

When Connected at COM3:

RS-485

Wiring diagram 1 - COM3

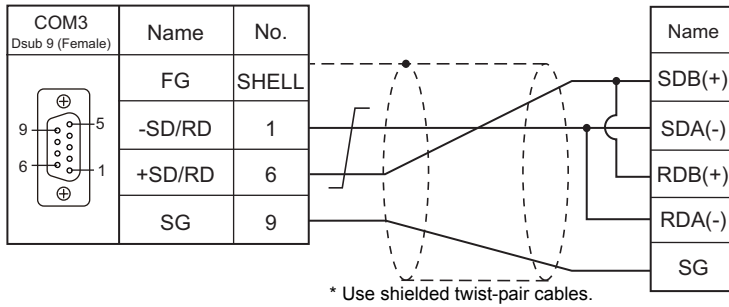

Wiring diagram 2 - COM3

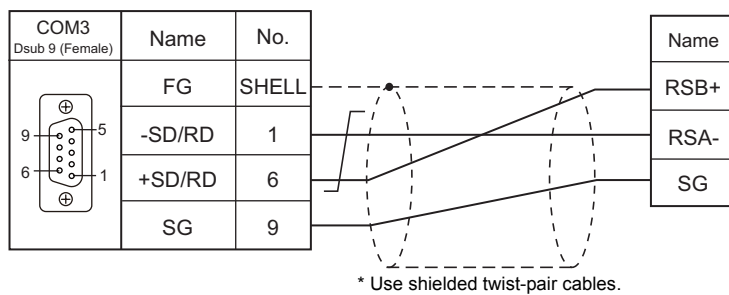

MEMO

Please use this page freely.

57. MODBUS

57.1 PLC Connection

57.1 PLC Connection

Serial Connection

The TS series works as the Modbus RTU master station. It can be connected with devices that support Modbus RTU communication.

PLC Selection on the Editor	Applicable Device	Signal Level	TS Port	Connection
MODBUS RTU	Modbus RTU slave device	RS-232C	COM2	Wiring diagram 1 - COM2
		RS-422	COM1	Wiring diagram 1 - COM1
		RS-485	COM1	Wiring diagram 2 - COM1
COM3	Wiring diagram 1 - COM3			
MODBUS RTU EXT Format	Modbus RTU slave device	RS-232C	COM2	Wiring diagram 1 - COM2
		RS-422	COM1	Wiring diagram 1 - COM1
		RS-485	COM1	Wiring diagram 2 - COM1
			COM3	Wiring diagram 1 - COM3

Ethernet Connection

The TS series works as the Modbus TCP/IP master station. It can be connected with devices that support Modbus TCP/IP slave communication.

PLC Selection on the Editor	Applicable Device	TCP/IP	UDP/IP	Port No.
MODBUS TCP/IP (Ethernet)	Modbus TCP/IP slave device	○	×	502 *
MODBUS TCP/IP (Ethernet) Sub Station	Modbus TCP/IP slave device			
MODBUS TCP/IP (Ethernet) EXT Format	Modbus TCP/IP slave device			

* Depending on the device specification, an arbitrary port number can be specified.

57.1.1 MODBUS RTU

Communication Setting

Editor

Communication setting

(Underlined setting: default)

Item	Setting	Remarks
Connection Mode	1 : 1 / <u>1 : n</u> / Multi-link2 / Multi-link2 (Ethernet) / 1 : n Multi-link2 (Ethernet)	
Signal Level	RS-232C / RS-422/485	
Baud Rate	4800 / <u>9600</u> / 19200 / 38400 / 57600 / 115K bps	
Data Length	8 bits	
Stop Bit	<u>1</u> / 2 bits	
Parity	None / <u>Odd</u> / Even	
Target Port No.	0 to 255	0: Broadcast

Format setting

Make communication format settings for each connected device.

- * If the maximum number of words to be read or written varies among the address ranges, select [MODBUS RTU EXT Format] for [Series] in the [Connection Device Selection] dialog and make extended format settings. For more information, see page 57-4.

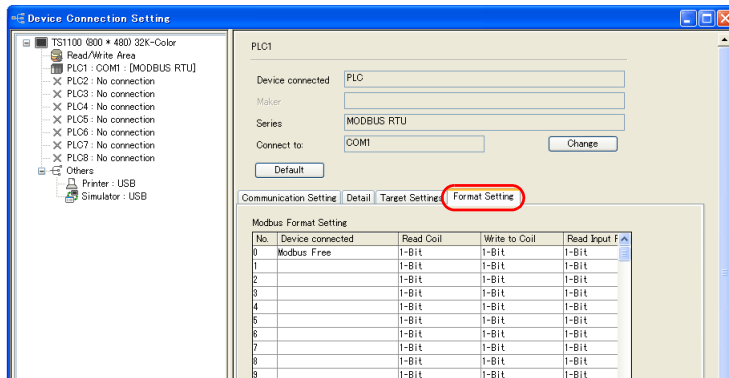

No. 1 to 255	Port number of the connected device
Read Coil	Format setting Set the number of words to be read or written at one time of communication for each memory. For details on the maximum value that can be set on V-SFT, see the table shown below.*1 The format setting also serves as the function code*1 setting used for Modbus communication. The available function codes vary depending on the device. Refer to the instruction manual of the connected device as well as the table shown below*1, and set the options on the dialog correctly.
Write to Coil	
Read Input Relay	
Read Holding Register	
Write Holding Register	
Read Input Register	

*1 Format setting on V-SFT and function code for the Modbus communication

V-SFT Format Setting		Maximum Setting	Modbus Communication Function Code
Operation			
Read Coil		992 bits	01H
Write to Coil	1 bit	1 word	05H
	16 bits or more	992 bits	0FH
Read Input Relay		992 bits	02H
Read Holding Register		62 words	03H
Write Holding Register	1 word	1 word	06H
	2 words or more	62 words	10H
Read Input Register		62 words	04H

PLC

Make communication settings of the connected device according to the settings made for the TS series. For more information on settings, refer to the instruction manual issued by the manufacturer.

Available Memory

The available memory setting range varies depending on the PLC model. Be sure to set within the range available for the PLC. Use [TYPE] when assigning the indirect memory for macro programs.

Memory	TYPE	Remarks
0 (output coil)	00H	
1 (input relay)	01H	
4 (holding register)	02H	
3 (input register)	03H	

Notes on Creating Screen Data

On the editor, the memory address is specified in decimal notation. Thus, when setting the address of the connected device that recognizes the memory address in hexadecimal notation, specify the value by converting the address into decimal one and add "1".

Setting example

- When specifying the PV (current value) RAM address "3814H" for Modbus RTU connection with Yamatake's "SDC35":
 - Convert the hexadecimal address into the decimal one.
3814HEX → 14356DEC
 - Add "1" to the decimal address.
14356 + 1 = 14357DEC
 - On the editor, specify "14357" for the holding register (4).

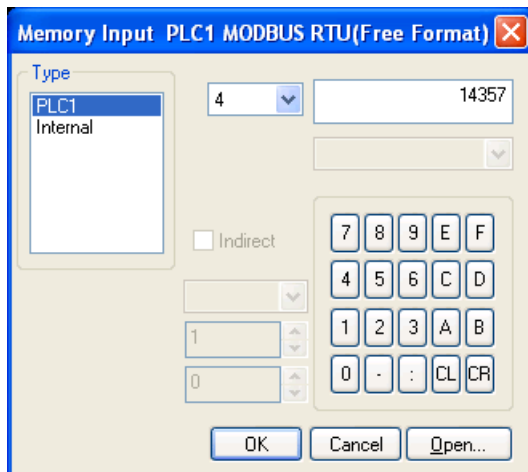

57.1.2 MODBUS RTU EXT Format

In the case with some Modbus RTU devices, the function code to be used or the maximum value to be read or written at one time varies depending on the address range even in the same device.

When [MODBUS RTU EXT Format] is selected, the address range as well as the communication format can be set as desired according to the specifications of the connected device. With [MODBUS RTU EXT Format] selected, since access will not be made to any address other than those specified in the format setting, communication can be performed effectively.

Communication Setting

Editor

Communication setting

(Underlined setting: default)

Item	Setting	Remarks
Connection Mode	<u>1 : 1</u> / <u>1 : n</u> / Multi-link2 / Multi-link2 (Ethernet) / <u>1 : n</u> Multi-link2 (Ethernet)	
Signal Level	RS-232C / <u>RS-422/485</u>	
Baud Rate	4800 / <u>9600</u> / 19200 / 38400 / 57600 / 115K bps	
Data Length	<u>8</u> bits	
Stop Bit	<u>1</u> / 2 bits	
Parity	None / <u>Odd</u> / Even	
Target Port No.	0 to 255	0: Broadcast

Extended format setting

Make communication format settings for the connected device.

[Common]

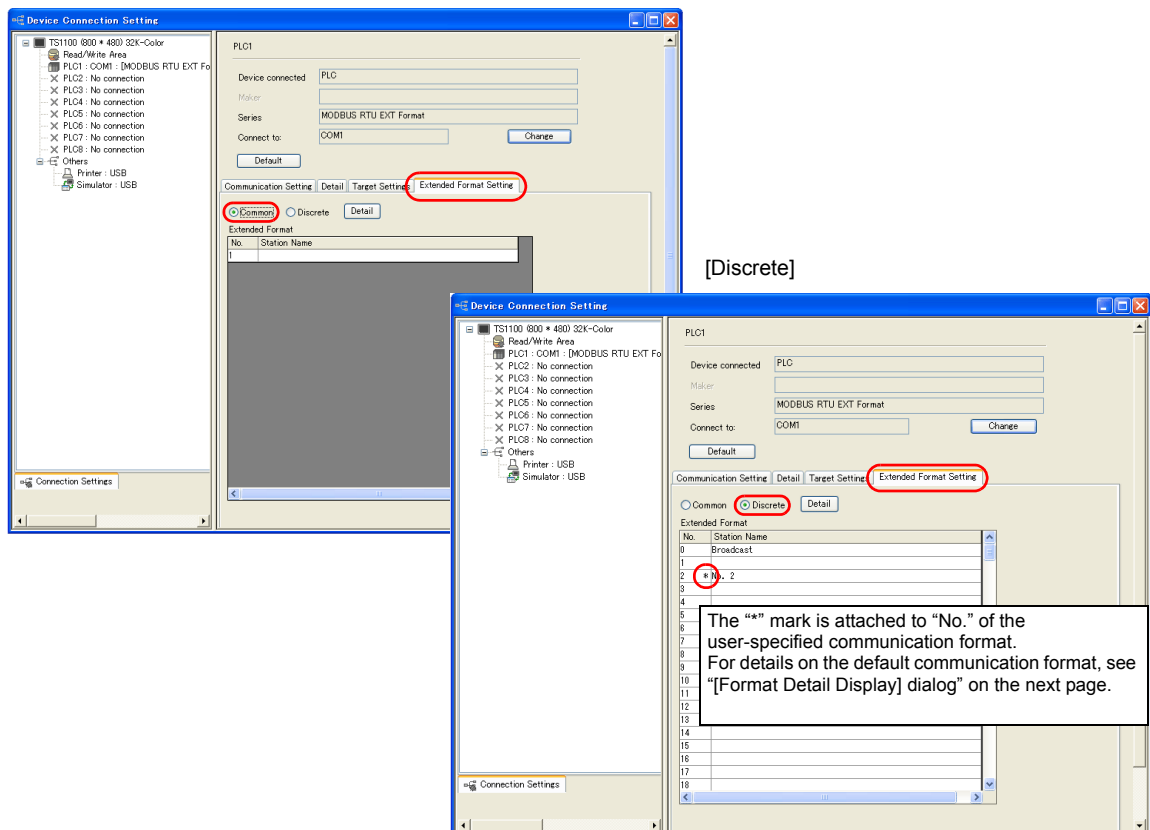

Common	Used to set the communication format commonly to all station numbers.
Discrete	Used to set a communication format for respective station numbers.
Detail	Displays the [Format Detail Display] dialog.
No.	Displays the station number of the connected device.
Station Name	Sets and displays the station name of the connected device.

[Format Detail Display] dialog

Register the communication format for each of the specified address range. Make the setting according to the device specification.

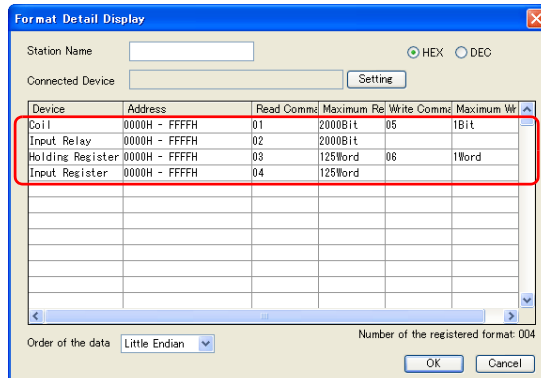

Four types of communication formats shown to the left have been registered by default.

Station Name	Register a desired station name.
Target Port No.	When [Discrete] is selected, the number of the selected station is automatically displayed.
HEX/DEC	Select the address notation. HEX / DEC
Device	Displays the currently registered device name. Coil / Input Relay / Holding Register / Input Register (default settings: one each, deletion impossible)
Address	Specify the address range for each device. HEX: 0000 to FFFF DEC: 1 to 65536 * The address range must not be duplicated.
Read Command	Set the communication format used for reading from or writing into the specified address range.
Maximum Read Value	<ul style="list-style-type: none"> [Read Command] / [Write Command] Specify the function code^{*1} to use for Modbus communication. The available function codes vary depending on the device. Refer to the instruction manual of the connected device as well as the table shown below^{*1}, and set the options on the dialog correctly.
Write Command	
Maximum Write Value	<ul style="list-style-type: none"> [Maximum Read Value] / [Maximum Write Value] Set the maximum value to be read or written at one time. Make the setting according to the device specification. For details on the maximum value that can be set for each device by using V-SFT, see the table shown below.^{*1}
Order of the data	Specify the ordering of data. Little Endian / Big Endian
Number of the registered format	Displays the number of currently registered formats. Default: 4 (deletion impossible) Max.: 255

*1 Device setting on V-SFT and function code for the Modbus communication

V-SFT Format Setting			Modbus Communication Function Code
Operation		Max. Read/Write Value	
Coil	Read		2000 bits
	Write	1 bit	1 bit
		2 bits or more	800 bits
Input Relay	Read		2000 bits
Holding Register	Read		125 words
	Write	1 word	1 word
		2 words or more	100 words
Input Register	Read		125 words

Adding a format

To add a format, select a device, right-click on the selected device and select [Add].

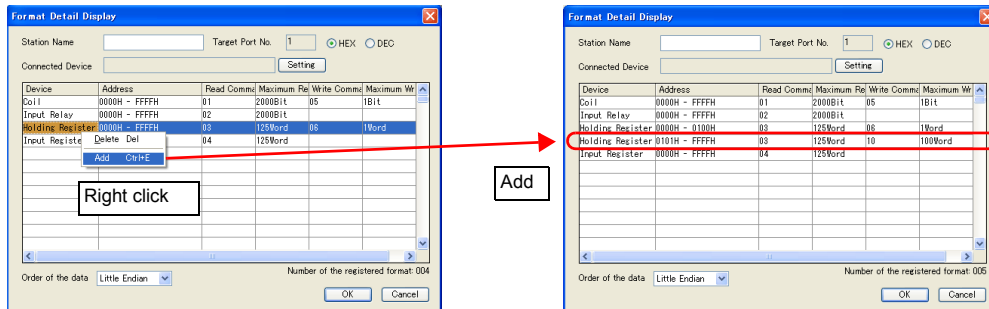

Setting example

When connecting a device which has the following specifications to station number 1:

Function Code	Operation	Max. Communication Points	Available Address	Example
01H	Read coil	4000	HEX: 0000 to 00FF DEC: 1 to 256	(1)
			HEX: 2EE0 to 4E1F DEC: 12001 to 20000	(2)
05H	Write single coil	1	HEX: 0000 to 00FF DEC: 1 to 256	(1)
0FH	Write multiple coils	1000	HEX: 2EE0 to 4E1F DEC: 12001 to 20000	(2)
03H	Read holding register	200	HEX: 0000 to 103F DEC: 1 to 8000	(3)
			HEX: 2EE0 to 2FDF DEC: 12001 to 12256	(4)
06H	Write single holding register	1	HEX: 2EE0 to 2FDF DEC: 12001 to 12256	(4)
10H	Write multiple holding registers	50	HEX: 0000 to 1F3F DEC: 1 to 8000	(3)

- Read/write coil

- (1) 0000 to 00FF (HEX)

- Register "01H" (function code for reading) to [Read Command] or "05H" (function code for writing) to [Write Command].
 - The maximum number of communication points to be read is 4000. Accordingly, register "2000 bits" for [Maximum Read Value] on V-SFT.
 - The maximum number of communication points to be written is 1. Accordingly, register "1 bit" for [Maximum Write Value] on V-SFT.

- (2) 2EE0 to 4E1F (HEX)

- Register "01H" (function code for reading) to [Read Command] or "0FH" (function code for writing) to [Write Command].
 - The maximum number of communication points to be read is 4000. Accordingly, register "2000 bits" for [Maximum Read Value] on V-SFT.
 - The maximum number of communication points to be written is 1000. Accordingly, register "800 bits" for [Maximum Write Value] on V-SFT.

- Read/write holding register

- (3) 0000 to 1F3F (HEX)

- Register "03H" (function code for reading) to [Read Command] or "10H" (function code for writing) to [Write Command].
 - The maximum number of communication points to be read is 200. Accordingly, register "125 words" for [Maximum Read Value] on V-SFT.
 - The maximum number of communication points to be written is 50. Accordingly, register "50 words" for [Maximum Write Value] on V-SFT.

- (4) 2EE0 to 2FDF (HEX)

- Register "03H" (function code for reading) to [Read Command] or "06H" (function code for writing) to [Write Command].
 - The maximum number of communication points to be read is 200. Accordingly, register "125 words" for [Maximum Read Value] on V-SFT.
 - The maximum number of communication points to be written is 1. Accordingly, register "1 word" for [Maximum Write Value] on V-SFT.

Station Name: sample Target Port No.: 1 HEX DEC

Connected Device: Setting

Device	Address	Read Comm	Maximum Re	Write Comm	Maximum W
(1) Coil	0000H - 00FFH	01	2000Bit	05	1Bit
(2) Coil	2EE0H - 4E1FH	01	2000Bit	0F	800Bit
(3) Input Relay	0000H - FFFFH	02	2000Bit		
(4) Holding Register	0000H - 0100H	03	125Word	10	50Word
Holding Register	2EE0H - 2FDH	03	125Word	06	1Word
Input Register	0000H - FFFFH	04	125Word		

Order of the data: Little Endian Number of the registered format: 006

OK Cancel

Access will not be made to any addresses other than those not registered on the dialog shown on the left.

- Coil: 0100 to 2EDF, 4E20 to FFFF
- Holding register: 1040 to 2EDF, 2FE0 to FFFF

PLC

Make communication settings of the connected device according to the settings made for the TS series. For more information on settings, refer to the instruction manual issued by the manufacturer.

Available Memory

The contents of "Available Memory" are the same as those described in "57.1.1 MODBUS RTU".

57.1.3 MODBUS TCP/IP (Ethernet)

Communication Setting

Editor

Make the following settings on the editor. For more information, see “Appendix 2 Ethernet”.

- IP address for the TS unit
- TS unit's port number in the [Communication Setting] tab window ([System Setting] → [Device Connection Setting])
- PLC's IP address and port number for [PLC Table] in the [Target Settings] tab window ([System Setting] → [Device Connection Setting])
- [System Setting] → [Device Connection Setting] → [Format Setting]

Format setting

Make communication format settings for each connected device. (See page 57-2.)

- * If the maximum number of words to be read or written varies among the address ranges, select [MODBUS TCP/IP (Ethernet) EXT Format] for [Series] in the [Connection Device Selection] dialog and make extended format settings. For more information, see page 57-9.

PLC

Make communication settings of the connected device according to the settings made for the TS series. For more information on settings, refer to the instruction manual issued by the manufacturer.

Available Memory

The available memory setting range varies depending on the PLC model. Be sure to set within the range available for the PLC. Use [TYPE] when assigning the indirect memory for macro programs.

Memory	TYPE	Remarks
0 (output coil)	00H	
1 (input relay)	01H	
4 (holding register)	02H	
3 (input register)	03H	

Notes on Creating Screen Data

On the editor, the memory address is specified in decimal notation. Thus, when setting the address of the connected device that recognizes the memory address in hexadecimal notation, specify the value by converting the address into decimal one and add "1". (See page 57-3.)

57.1.4 MODBUS TCP/IP (Ethernet) EXT Format

In the case with some Modbus TCP/IP (Ethernet) devices, the function code to be used or the maximum value to be read or written at one time varies depending on the address range even in the same device.

When [MODBUS TCP/IP (Ethernet) EXT Format] is selected, the address range as well as the communication format can be set as desired according to the specifications of the connected device. With [MODBUS TCP/IP (Ethernet) EXT Format] selected, since access will not be made to any address other than those specified in the format setting, communication can be performed effectively.

Communication Setting

Editor

Make the following settings on the editor. For more information, see “Appendix 2 Ethernet”.

- IP address for the TS unit
- TS unit's port number in the [Communication Setting] tab window ([System Setting] → [Device Connection Setting])
- PLC's IP address and port number for [PLC Table] in the [Target Settings] tab window ([System Setting] → [Device Connection Setting])
- [System Setting] → [Device Connection Setting] → [Format Setting]

Extended format setting

Make communication format settings for the connected device.

[Common]

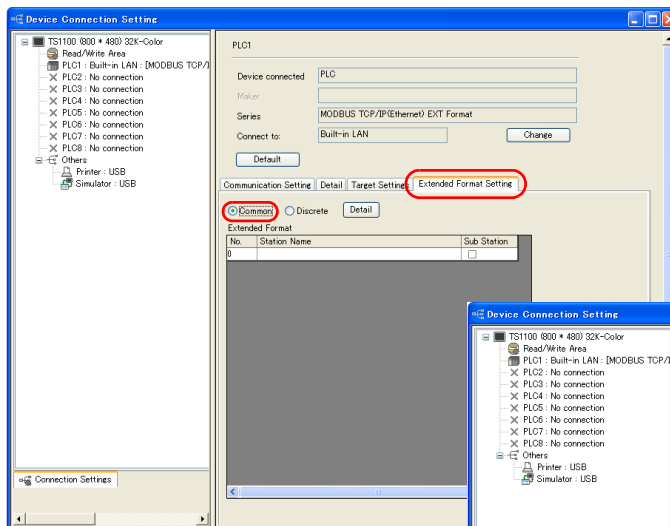

[Discrete]

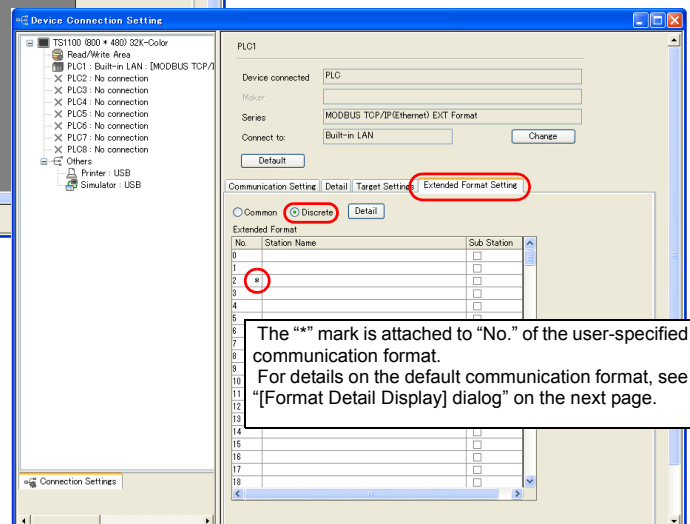

Common	Used to set the communication format commonly to all station numbers.
Discrete	Used to set a communication format for respective station numbers.
Detail	Displays the [Format Detail Display] dialog.
No.	Displays the station number of the connected device.
Station Name	Sets and displays the station name of the connected device.
Sub Station	Check the box when Modbus TCP/IP communication is to be performed with a device requiring a unit ID specification. When this box is checked, the unit ID can be specified when setting the memory address. (Without check: The unit ID is fixed to "FFH".)

[Format Detail Display] dialog

Register the communication format for each of the specified address range. Make the setting according to the device specification.

Four types of communication formats shown to the left have been registered by default.

Station Name	Register a desired station name.
Target Port No.	When [Discrete] is selected, the number of the selected station is automatically displayed.
HEX/DEC	Select the address notation. HEX / DEC
Device	Displays the currently registered device name. Coil / Input Relay / Holding Register / Input Register (default settings: one each, deletion impossible)
Address	Specify the address range for each device. HEX: 0000 to FFFF DEC: 1 to 65536 * The address range must not be duplicated.
Read Command	Set the communication format used for reading from or writing into the specified address range.
Maximum Read Value	<ul style="list-style-type: none"> [Read Command] / [Write Command] Specify the function code^{*1} to use for Modbus communication. The available function codes vary depending on the device. Refer to the instruction manual of the connected device as well as the table shown below^{*1}, and set the options on the dialog correctly.
Write Command	<ul style="list-style-type: none"> [Maximum Read Value] / [Maximum Write Value] Set the maximum value to be read or written at one time. Make the setting according to the device specification. For details on the maximum value that can be set for each device by using V-SFT, see the table shown below.^{*1}
Order of the data	Specify the ordering of data. Little Endian / Big Endian
<input type="checkbox"/> Sub Station	Check this box when using the sub station function.
Number of the registered format	Displays the number of currently registered formats. Default: 4 (deletion impossible) Max.: 255

*1 Device setting on V-SFT and function code for the Modbus communication

V-SFT Format Setting			Modbus Communication Function Code	
Operation	Max. Read/Write Value			
Coil	Read		2000 bits	01H
	Write	1 bit	1 bit	05H
		2 bits or more	800 bits	0FH
Input Relay	Read		2000 bits	02H
Holding Register	Read		125 words	03H
	Write	1 word	1 word	06H
		2 words or more	100 words	10H
Input Register	Read		125 words	04H

Adding a format

To add a format, select a device, right-click on the selected device and select [Add].

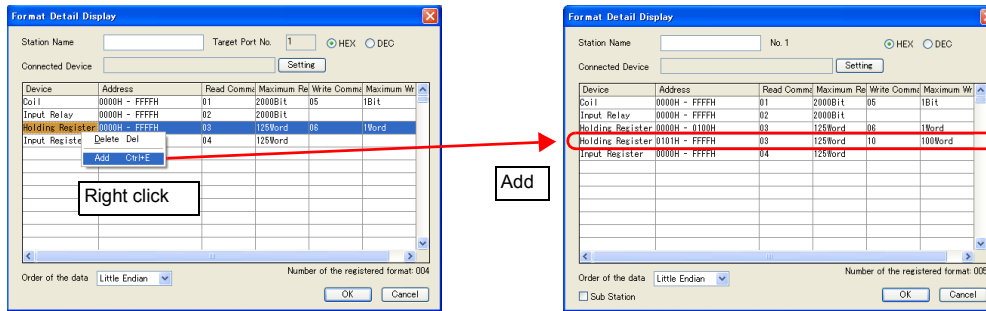

Example

When connecting a device which has the following specifications to station number 1:

Function Code	Operation	Max. Communication Points	Available Address	Example
01H	Read coil	4000	HEX: 0000 to 00FF DEC: 1 to 256	(1)
			HEX: 2EE0 to 4E1F DEC: 12001 to 20000	(2)
05H	Write single coil	1	HEX: 0000 to 00FF DEC: 1 to 256	(1)
0FH	Write multiple coils	1000	HEX: 2EE0 to 4E1F DEC: 12001 to 20000	(2)
03H	Read holding register	200	HEX: 0000 to 103F DEC: 1 to 8000	(3)
			HEX: 2EE0 to 2FDF DEC: 12001 to 12256	(4)
06H	Write single holding register	1	HEX: 2EE0 to 2FDF DEC: 12001 to 12256	(4)
10H	Write multiple holding registers	50	HEX: 0000 to 1F3F DEC: 1 to 8000	(3)

- Read/write coil

(1) 0000 to 00FF (HEX)

- Register "01H" (function code for reading) to [Read Command] or "05H" (function code for writing) to [Write Command].
- The maximum number of communication points to be read is 4000. Accordingly, register "2000 bits" for [Maximum Read Value] on V-SFT.
- The maximum number of communication points to be written is 1. Accordingly, register "1 bit" for [Maximum Write Value] on V-SFT.

(2) 2EE0 to 4E1F (HEX)

- Register "01H" (function code for reading) to [Read Command] or "0FH" (function code for writing) to [Write Command].
- The maximum number of communication points to be read is 4000. Accordingly, register "2000 bits" for [Maximum Read Value] on V-SFT.
- The maximum number of communication points to be written is 1000. Accordingly, register "800 bits" for [Maximum Write Value] on V-SFT.

- Read/write holding register

(3) 0000 to 1F3F (HEX)

- Register "03H" (function code for reading) to [Read Command] or "10H" (function code for writing) to [Write Command].
- The maximum number of communication points to be read is 200. Accordingly, register "125 words" for [Maximum Read Value] on V-SFT.
- The maximum number of communication points to be written is 50. Accordingly, register "50 words" for [Maximum Write Value] on V-SFT.

(4) 2EE0 to 2FDF (HEX)

- Register "03H" (function code for reading) to [Read Command] or "06H" (function code for writing) to [Write Command].
- The maximum number of communication points to be read is 200. Accordingly, register "125 words" for [Maximum Read Value] on V-SFT.
- The maximum number of communication points to be written is 1. Accordingly, register "1 word" for [Maximum Write Value] on V-SFT.

Station Name: sample No. 1 HEX DEC

Connected Device: Setting

Device	Address	Read Comma	Maximum Re	Write Comma	Maximum W
(1) Coil	0000H - 00FFH	01	2000Bit	05	1Bit
(2) Coil	2EE0H - 4E1FH	01	2000Bit	0F	800Bit
Input Relay	0000H - FFFFH	02	2000Bit		
(3) Holding Register	0000H - 0100H	03	125Word	10	50Word
(4) Holding Register	2EE0H - 2FD0H	03	125Word	06	1Word
Input Register	0000H - FFFFH	04	125Word		

Order of the data: Little Endian Number of the registered format: 006

Sub Station

Access will not be made to any addresses other than those not registered on the dialog shown on the left.

- Coil: 0100 to 2EDF, 4E20 to FFFF
- Holding register: 1040 to 2EDF, 2FE0 to FFFF

PLC

Make communication settings of the connected device according to the settings made for the TS series. For more information on settings, refer to the instruction manual issued by the manufacturer.

Available Memory

The contents of "Available Memory" are the same as those described in "57.1.3 MODBUS TCP/IP (Ethernet)".

57.1.5 MODBUS TCP/IP (Ethernet) Sub Station

- Modbus TCP/IP (Ethernet) communication with devices which require unit ID specifications

- [Connection Mode]: "1 : n"

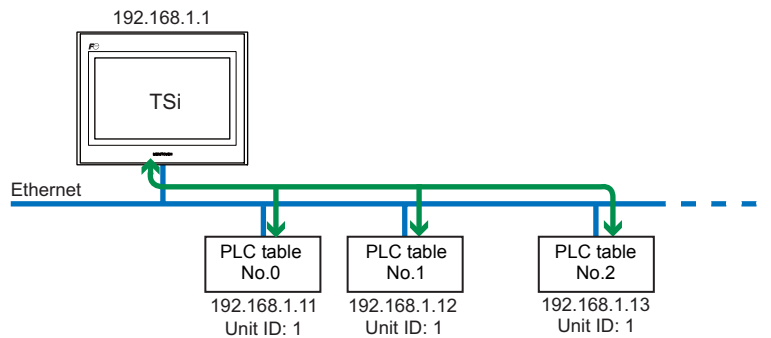

- Serial communication with Modbus devices via relay station

- [Connection Mode]: "1 : 1"

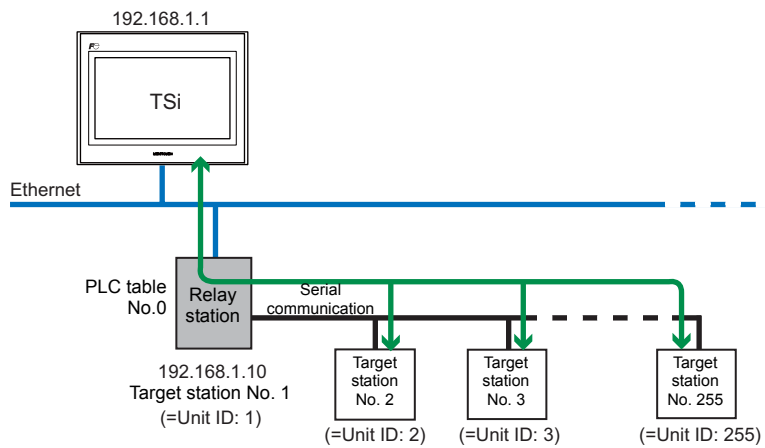

Communication Setting

Editor

Make the following settings on the editor. For more information, see "Appendix 2 Ethernet".

- IP address for the TS unit
- TS unit's port number in the [Communication Setting] tab window ([System Setting] → [Device Connection Setting])
- PLC's IP address and port number for [PLC Table] in the [Target Settings] tab window ([System Setting] → [Device Connection Setting])
- [System Setting] → [Device Connection Setting] → [Format Setting]

Format setting

Make communication format settings for each connected device. (See page 57-2.)

PLC

Make communication settings of the connected device according to the settings made for the TS series. For more information on settings, refer to the instruction manual issued by the manufacturer.

Available Memory

The available memory setting range varies depending on the PLC model. Be sure to set within the range available for the PLC. Use [TYPE] when assigning the indirect memory for macro programs.

Memory	TYPE	Remarks
0 (output coil)	00H	
1 (input relay)	01H	
4 (holding register)	02H	
3 (input register)	03H	

Notes on Creating Screen Data

- On the editor, the memory address is specified in decimal notation. Thus, when setting the address of the connected device that recognizes the memory address in hexadecimal notation, specify the value by converting the address into decimal one and add "1". (See page 57-3.)
- Set the unit ID when specifying the memory address.
 - [Connection Mode]: "1 : 1"

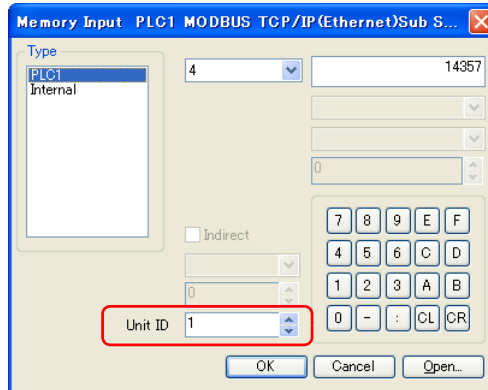

- [Connection Mode]: "1 : n"

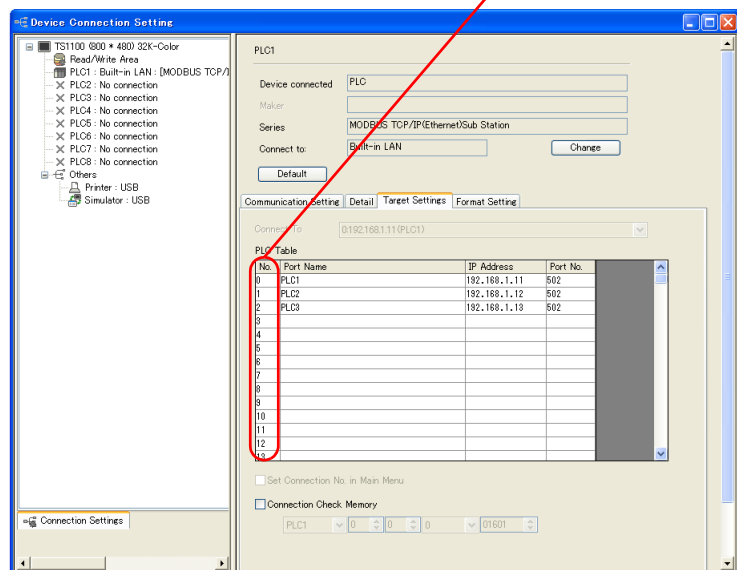
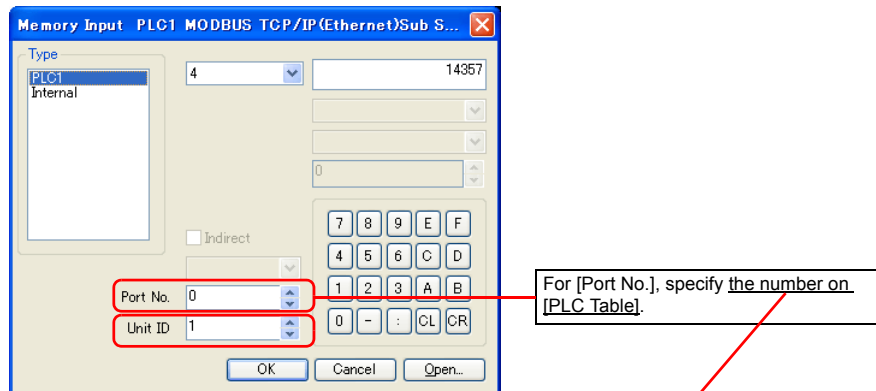

57.1.6 Wiring Diagrams

When Connected at COM1:

RS-422/RS-485

Wiring diagram 1 - COM1

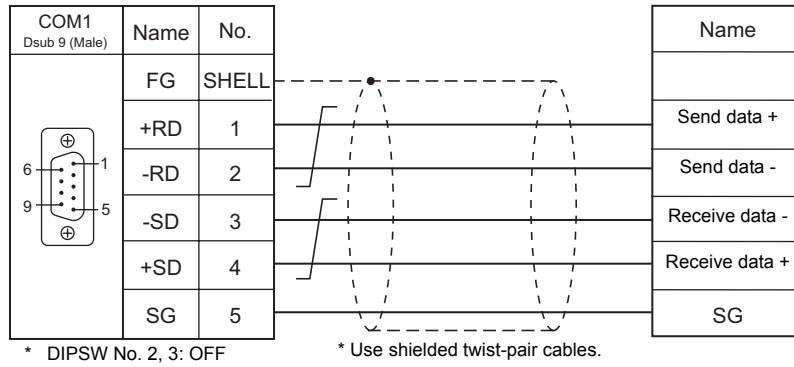

Wiring diagram 2 - COM1

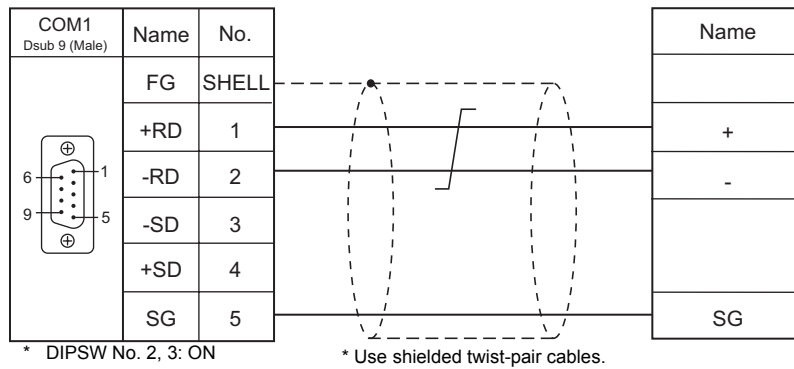

When Connected at COM2:

RS-232C

Wiring diagram 1 - COM2

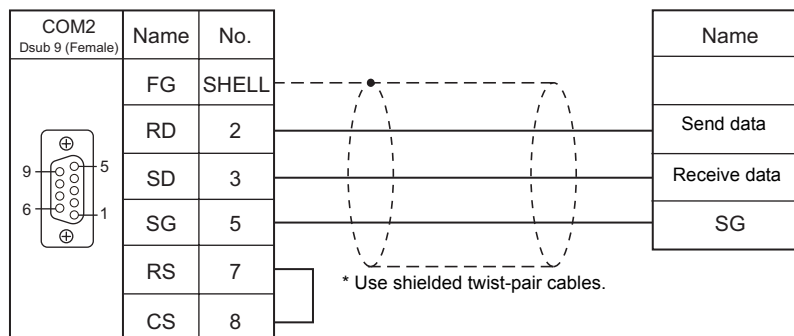

When Connected at COM3:

RS-485

Wiring diagram 1 - COM3

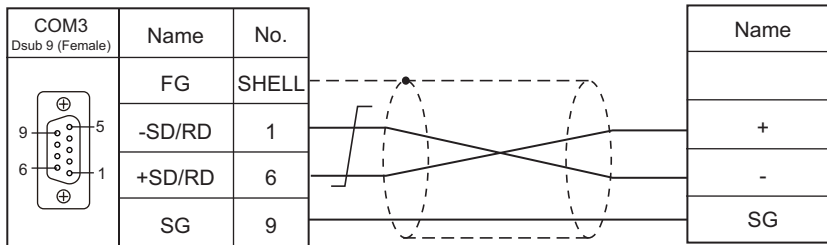

* Use shielded twist-pair cables.

58. Barcode Reader

58.1 Barcode Reader Connection

58.1 Barcode Reader Connection

Barcode readers can be connected to the serial port or USB-A port at the TS series. The controller models shown below can be connected.

Serial Connection

Manufacturer	Model	Signal Level	TS Port	Connection
Tohken	THIR-6000 THIR-3000N-RF TFIR3102 THLS-6800 TLMS-3500RV THLS6912	RS-232C	COM2	Wiring diagram 1 - COM2
OMRON	V500-R521b V520-RH series			
KEYENCE	BL-210R BL-600 series BL-N60R BL-80R			
Cognex	In-Sight 5100 In-Sight 5400			
Nichiei Intec	FFTA10ARS			
Unitech	MS210-1			
SICK	LD9000E			
OLYMPUS-symbol	LSH3502			
symbol	LS2104			
WelchAllyn	IT3800			

Match communication settings of the barcode reader to those made on the TS series. For more information on settings, refer to the specifications issued by the manufacturer.

USB Connection

Use a barcode reader which is compatible with USB-HID.

Manufacturer	Model	Remarks
Tohken	THLS-6922USB THLS-6800 THIR-6000U	HID mode
KEYENCE	BL-N60UB	
Cognex	Dataman710	
DENSO	AT10Q-SM	USB keyboard interface
AIMEX	BW-880UB	

58.1.1 Communication Setting

Editor

Device selection

Select [Barcode] at [Device] for the logical ports PLC2 to 8. [Barcode] cannot be selected for PLC1.

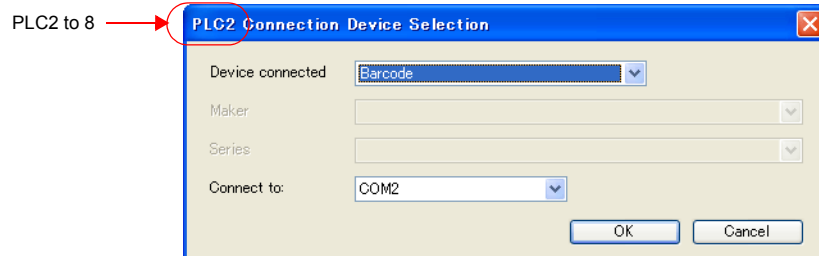

Communication setting

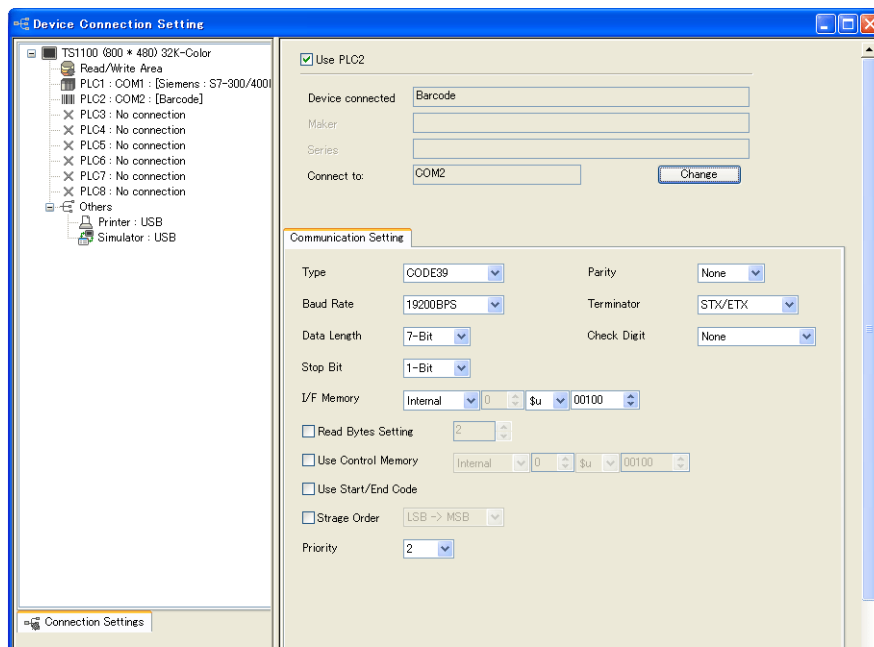

(Underlined setting: default)

Item	Setting	Remarks
Type	<u>JAN</u> / ITF / CODABAR / CODE39 / ANY / CODE128 ^{*1}	
Baud Rate	<u>4800</u> / 9600 / 19200 bps	Valid for serial connection
Data Length	<u>7</u> / 8 bits	
Stop Bit	<u>1</u> / 2 bits	
Parity	<u>None</u> / Odd / Even	
Terminator	<u>STX/ETX</u> / CR/LF / CR	
Check Digit	<u>None</u> / Do Not Delete / Delete	
I/F Memory	See "58.1.2 I/F Memory" (page 58-3).	
Read Bytes Setting		
Use Control Memory	See "58.1.3 Control Memory" (page 58-4).	
Use Start/End Code	<ul style="list-style-type: none"> When checked: Data is saved with "*" attached. When unchecked: Data is saved without "*". 	Enabled when [CODE39] is selected for [Type].
Storage Order	<ul style="list-style-type: none"> When checked: LSB → MSB / MSB → LSB When unchecked: (I/F memory: internal memory) MSB → LSB When unchecked: (I/F memory: PLC memory) According to the setting ([Communication Setting] → [Text Process]) made for each PLC 	Data is stored into I/F memory in order according to the setting specified here.

*1 When [CODE128] is selected, 128 characters of ASCII code (numbers, alphabet, symbols, control characters) can be used; however, control characters cannot be read on a USB barcode reader. When using control characters, connect the barcode reader via serial connection.

58.1.2 I/F Memory

I/F memory stores barcode information. The number of words used varies depending on the setting.

I/F Memory

Type: JAN / ITF / CORDABAR / CODE39

Memory	Contents																		
n	Flag / the number of bytes read <table border="1" style="margin-left: 20px;"> <tr> <td>15</td><td>14</td><td>13</td><td>12</td><td>11</td><td>10</td><td>9</td><td>-</td><td>0</td> </tr> <tr> <td>0</td><td></td><td>0</td><td></td><td>0</td><td>0</td><td></td><td></td><td></td> </tr> </table> <p style="margin-left: 20px;"> Communication error Reading complete The number of bytes read (0 to 256 bytes) </p> <p>* Be sure to reset the bits not in use to "0".</p>	15	14	13	12	11	10	9	-	0	0		0		0	0			
15	14	13	12	11	10	9	-	0											
0		0		0	0														
n + 1	Data read (ASCII) * "0" (null code) is attached to the last.																		
:																			
n + m																			

Type : ANY

Memory	Contents																		
n	Flag <table border="1" style="margin-left: 20px;"> <tr> <td>15</td><td>14</td><td>13</td><td>12</td><td>11</td><td>10</td><td>9</td><td>-</td><td>0</td> </tr> <tr> <td>0</td><td></td><td>0</td><td></td><td>0</td><td>0</td><td>0</td><td>-</td><td>0</td> </tr> </table> <p style="margin-left: 20px;"> Communication error Reading complete </p> <p>* Be sure to reset the bits not in use to "0".</p>	15	14	13	12	11	10	9	-	0	0		0		0	0	0	-	0
15	14	13	12	11	10	9	-	0											
0		0		0	0	0	-	0											
n + 1	The number of bytes read (0 to 2048 bytes)																		
n + 2	Data read (ASCII) * "0" (null code) is attached to the last.																		
:																			
n + m																			

Details of flag

Communication error	When an error occurs in communication between the barcode reader and the TS series, "1" is set. Check the communication settings and wiring.
Reading complete	When data received from the barcode reader has been written into the I/F memory, "1" is set. When this bit is set, reset it to "0" before reading the next data.
The number of bytes read	Stores the number of bytes read from the barcode reader.

Read Bytes Setting

The number of bytes that can be read is determined according to the settings at [Type] and [Read Bytes Setting].

Type	Read Bytes Setting	Allowable Number of Bytes
JAN ITF CODERBAR CODE39 CODE128	Not specified	Variable according to the code to be read Max. 254 bytes
	Specified	Fixed to the specified number of words (2 to 254 bytes)
ANY	Not specified	Variable according to the code to be read Max. 2046 bytes
	Specified	Fixed to the specified number of words (2 to 2046 bytes)

• Example

I/F Memory: D100
 Read Bytes Setting: Specified
 Bytes: 10 bytes
 Text Process: LSB → MSB

- If data greater than 10 bytes (“4902580302474”) is read:
 10 bytes of data are stored and the remaining data is discarded.

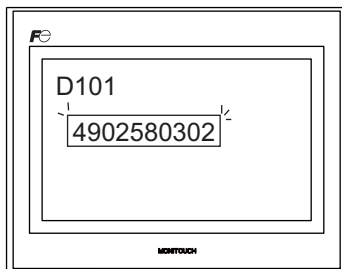

I/F Memory	Value
D100	Flag Number of read data
D101	3934HEX
D102	3230HEX
D103	3835HEX
D104	3330HEX
D105	3230HEX
D106	Not used



- If data of 10 bytes or smaller (“12345”) is read:
 “HEX 0” is assigned to the address where no data is stored.

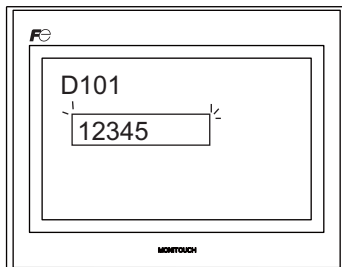

I/F Memory	Value
D100	Flag Number of read data
D101	3231HEX
D102	3433HEX
D103	0035HEX
D104	0000HEX
D105	0000HEX
D106	Not used



58.1.3 Control Memory

Reading operation of the barcode reader can be controlled by using read enable bit of the control memory.

Control Memory

15	14	13	12	11	10	9	8	7	6	5	4	3	2	1	0
0	0	0	0	0	0	0	0	0	0	0	0	0	0	0	0

Not used

Read enable bit
 0: Disabled
 1: Enabled

- Bit 0: Read enable bit
 Data is stored into I/F memory when bit 0 is set.

* A bit array of the PLC control memory may be different from the one shown above depending on the PLC model. Set the bit according to the PLC specification.

58.1.4 Wiring Diagrams

When Connected at COM2:

RS-232C

Wiring diagram 1 - COM2

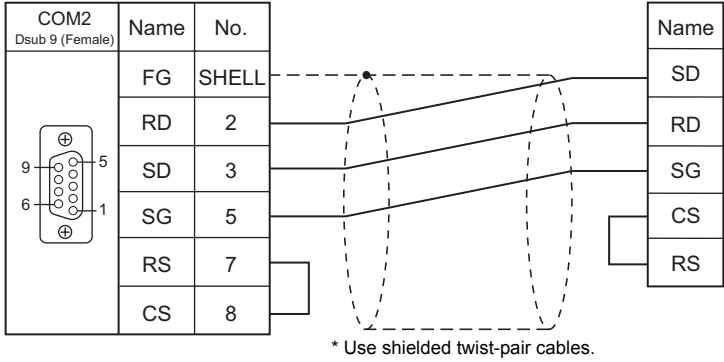

CAUTION

- For barcode readers with CS/RS control, a jumper may need to be installed between the CS and RS to maintain proper operation.

MEMO

Please use this page freely.

59. Slave Communication Function

- 59.1 V-Link
- 59.2 Modbus RTU Slave Communication
- 59.3 Modbus TCP/IP Slave Communication

59.1 V-Link

59.1.1 Overview

- "V-Link" is the network where the computer reads from and writes to the internal memory of the TS series, memory card, or PLC1 to 8 memory using a dedicated protocol.

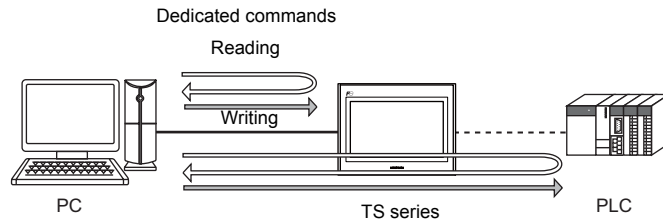

- Use COM1, COM2 or COM3 for connection with a general-purpose computer.
 - Data of the connected devices can be collected through communications with the TS series. Data collection is available even between devices of different manufacturers.
 - Either signal level RS-232C or RS-485 can be selected.
With RS-232C, one TS series unit can be connected; with RS-485, a maximum of 31 TS series units can be connected.
- RS-485 connection

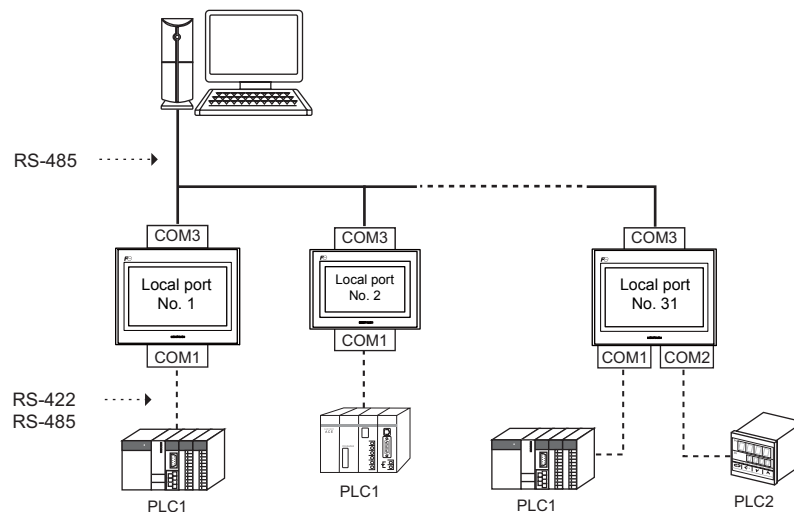

59.1.2 Communication Setting

Editor

Device selection

Select [V-Link] at [Device] for the logical ports PLC2 to 8. [V-Link] cannot be selected for PLC1.

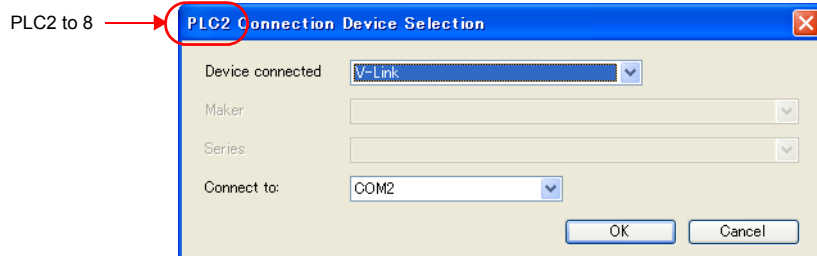

Communication setting

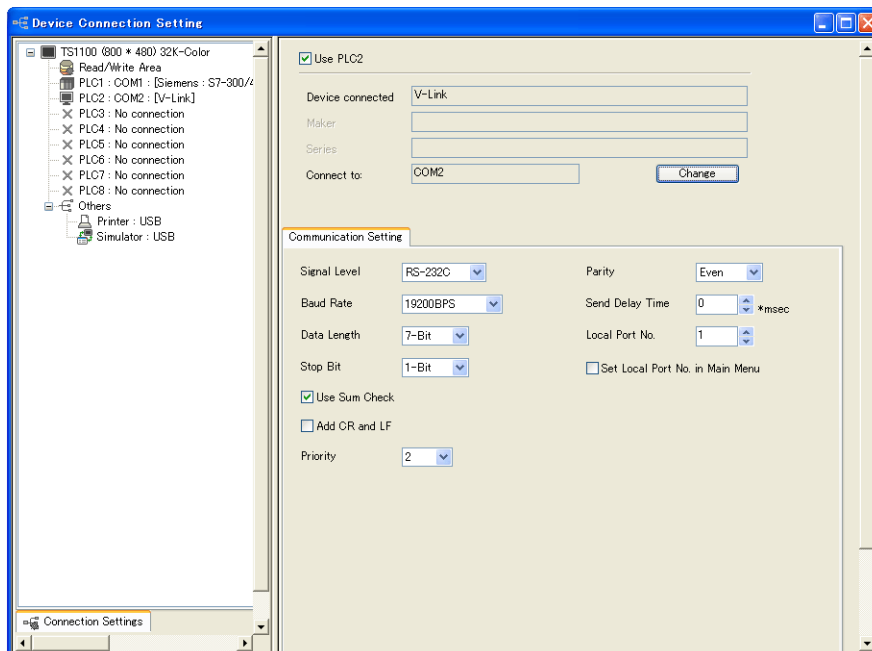

(Underlined setting: default)

Item	Setting
Signal Level	<u>RS-232C</u> / RS-485
Baud Rate	4800 / 9600 / <u>19200</u> / 38400 / 57600 / 115 Kbps
Data Length	<u>7</u> / 8 bits
Stop Bit	<u>1</u> / 2 bits
Parity	None / Odd / <u>Even</u>
Send Delay Time	<u>0</u> to 255 msec
Local Port No.	<u>1</u> to 254 (Maximum connectable units: 31)
<input type="checkbox"/> Set Local Port No. in Main Menu	<ul style="list-style-type: none"> • <u>Unchecked</u>: Set the local port number for screen data. • Checked: Set the local port number on TS series (see page 59-3).
<input type="checkbox"/> Use Sum Check	<u>Checked</u> / unchecked
<input type="checkbox"/> Add CR and LF	Checked / <u>unchecked</u>

TS series

Local port number setting (Main Menu)

When [Set Local Port No. in Main Menu] is checked in the [Communication Setting] tab window for V-Link, the local port number must be set on the Main Menu screen of the TS series.

1. Transfer screen data.
2. Bring up the Main Menu screen on TS series.
3. Hold down the [Editor: USB] switch at the lower left corner of the screen for 3 seconds or longer. The Extended Function Setting screen is displayed.

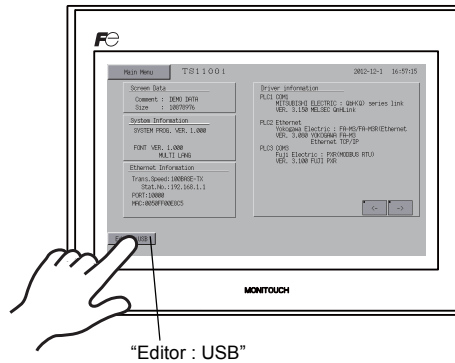

4. Display the [Local No.] field using the [Up] or [Down] switch. (See (1) in the figure below.)

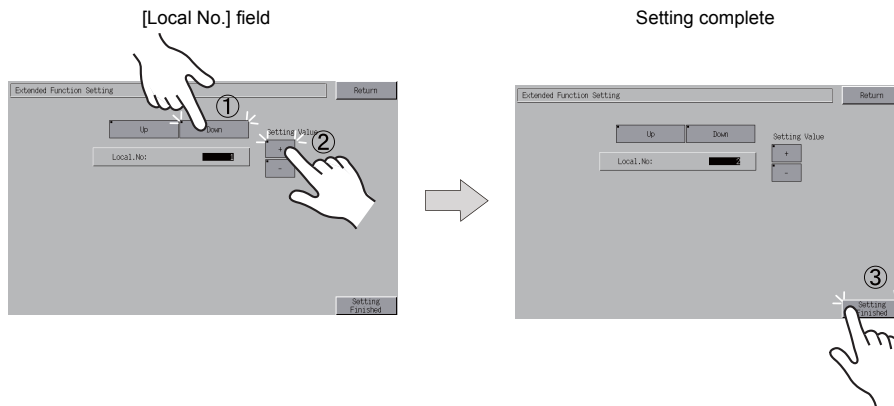

5. Set the local port number using the [Up] and [Down] switches. (See (2) in the figure above.)
6. Press the [Setting Finished] switch. The Main Menu screen is displayed again. (See (3) in the figure above.)

The local port number specified here is commonly used for V-Link, Modbus slave and Multi-link communications. Set a number within the range of these communications.

- V-Link: 1 to 254
- Modbus slave: 1 to 31
- Multi-link: 1 to 32

59.1.3 Wiring Diagrams

When Connected at COM1:

RS-485

Connect a computer to the COM1 port of the TS unit via RS-485. A maximum of 31 TS units can be connected.

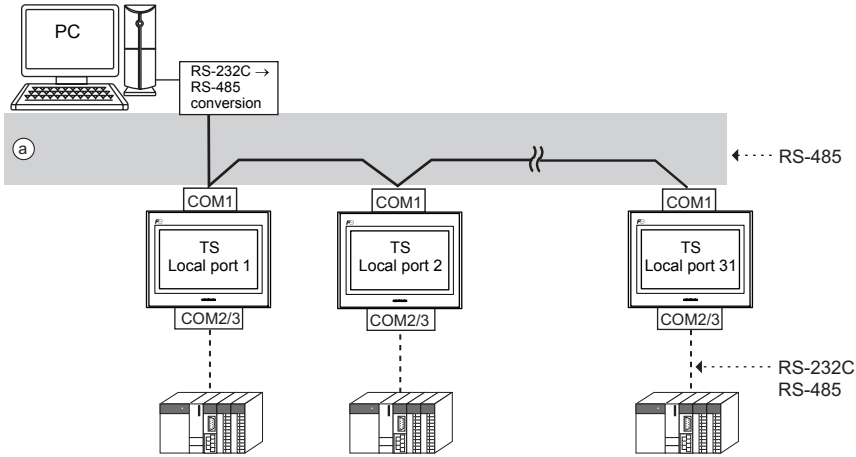

- Wiring example of above (a)
 - DIPSW No. 2, 3: ON (COM1 RS-485: 2-wire connection)
 - DIPSW No. 6, 7: Terminating resistance

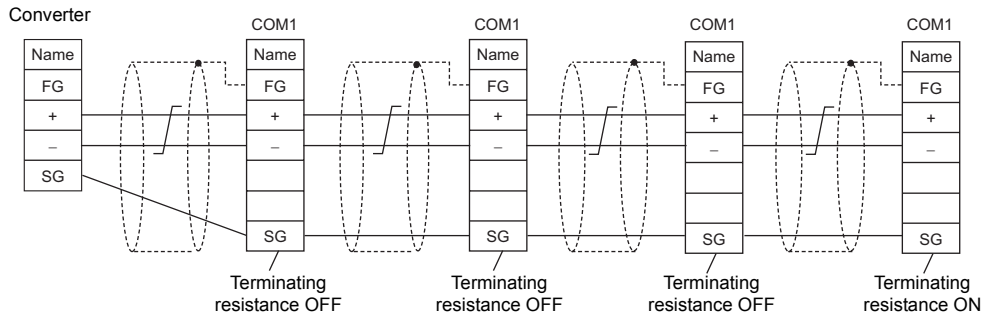

When Connected at COM2:

RS-232C

Connect a computer to the COM2 port of the TS unit via RS-232C.

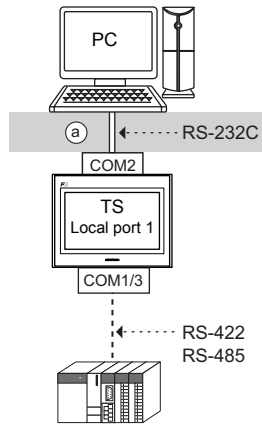

- Wiring example of above (a)

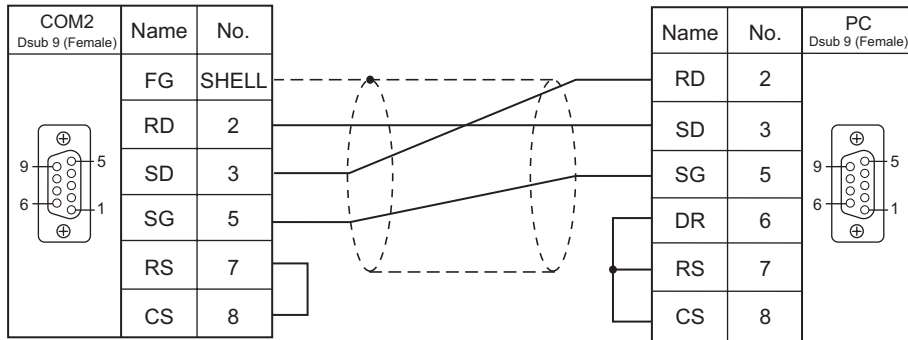

When Connected at COM3:

RS-485 (31 TS Units Maximum)

Connect a computer to the COM3 port of the TS unit via RS-485. A maximum of 31 TS units can be connected.

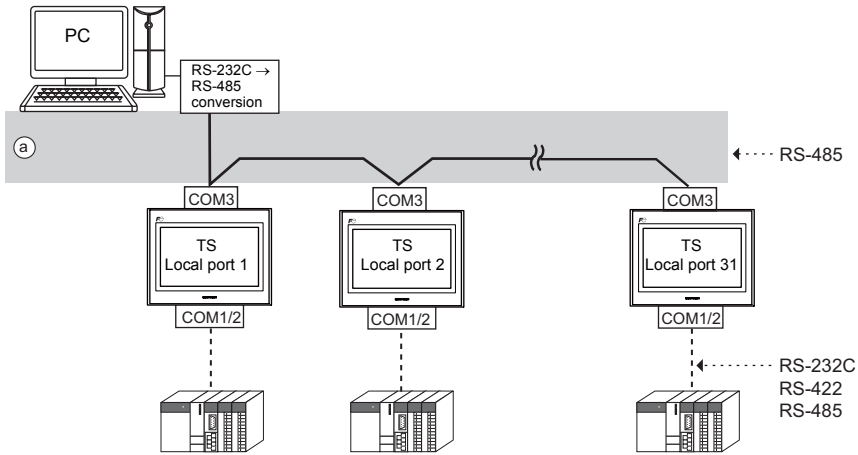

- Wiring example of above (a)
 - DIPSW No. 8 : Terminal resistance setting

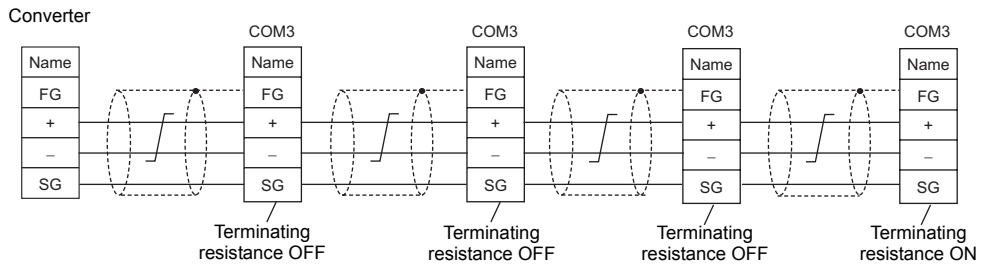

59.1.4 Protocol

Read (with Sum Check and CR/LF)

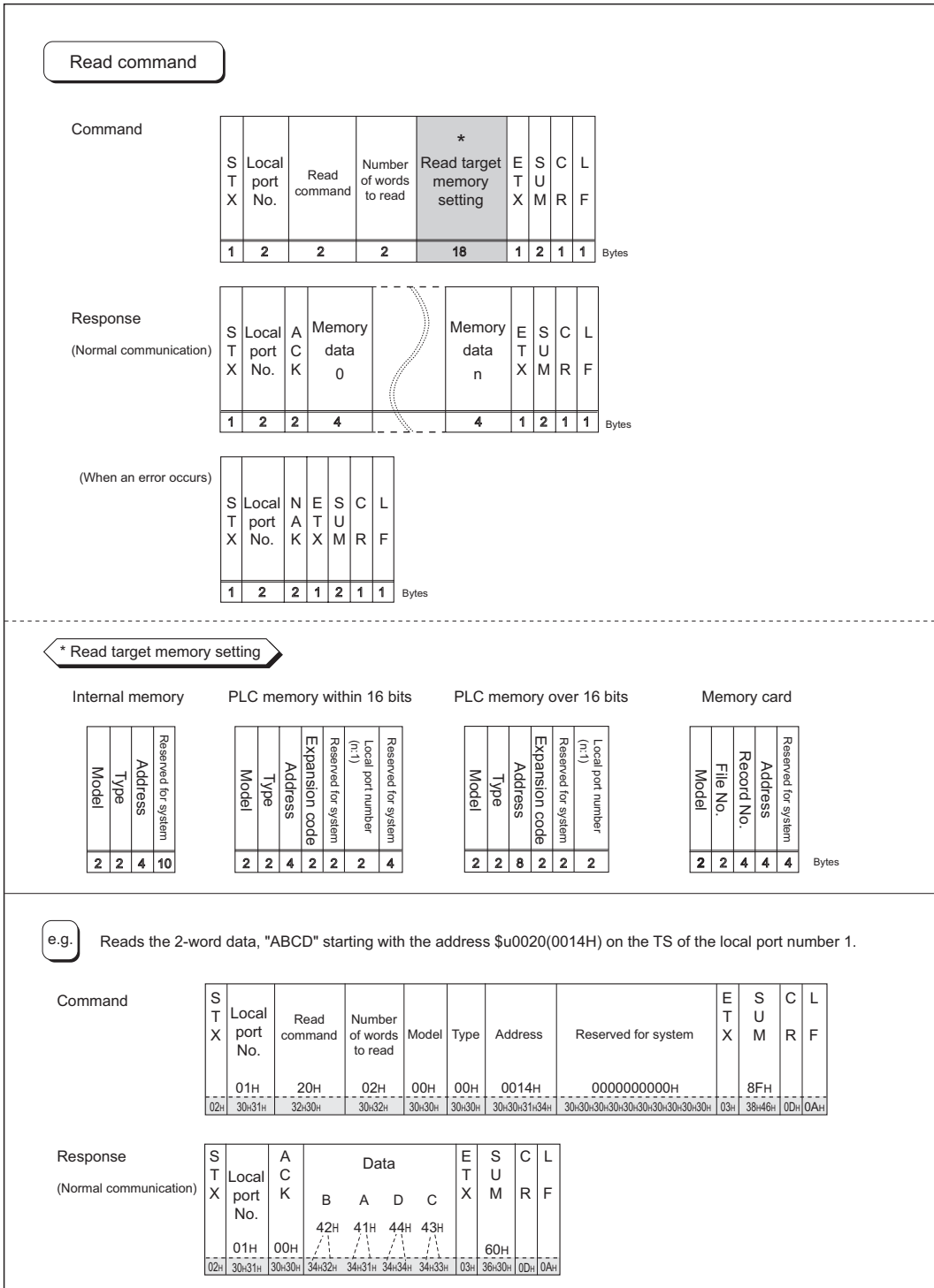

Write (with Sum Check and CR/LF)

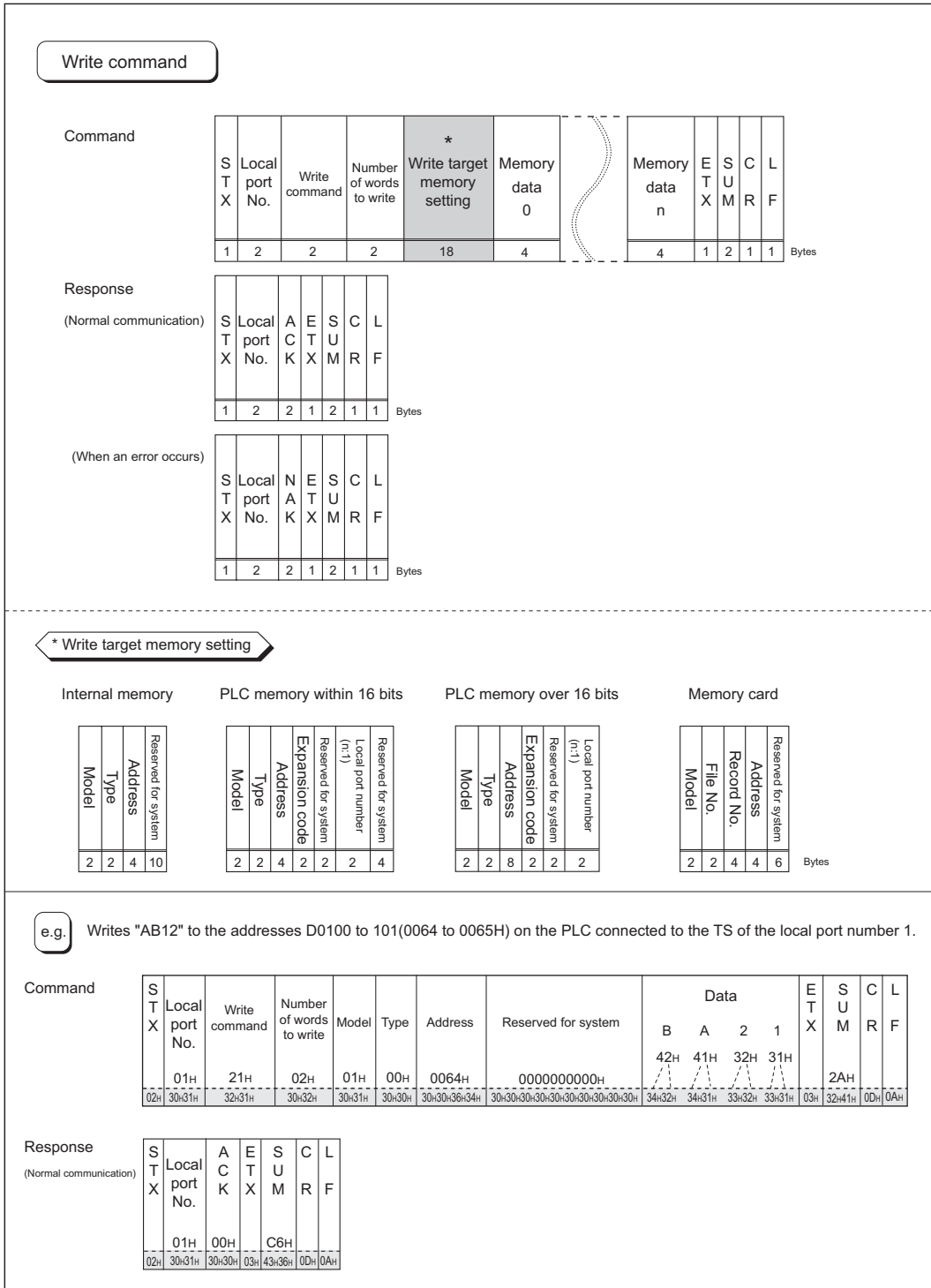

Items for Protocols

Transmission control code: 1 byte

Signal Name	Code (Hexadecimal)	Content
STX	02H	Start of transmission block
ETX	03H	End of transmission block
CR	0DH	Carriage return
LF	0AH	Line feed

Local port number: 2 bytes

Local port numbers are used so that the host computer can identify each TS series for access. The data range is from 01H to 1FH (1 to 31) and is converted into the ASCII code before use. Set the TS series' local port number for [Local Port No.] on the editor. See page 59-2.

Command: 2 bytes

Available commands are shown below.

Name	Code (Hexadecimal)	ASCII	Content
Read	20H	32 30	Read from memory
Write	21H	32 31	Write to memory

The number of words to be read or written: 2 bytes

Set the number of words to be read or written by one command. The data range is from 01H to FFH (1 to 255) and is converted into the ASCII code before use.

Memory address to be read or written: 18 bytes

Specify the memory address to be accessed.

Set the following code in the format as shown for "Read target memory setting" on page 59-7 and "Write target memory setting" on page 59-8.

- Model

Memory	Word Address		Double-word Address	
	Code (Hexadecimal)	ASCII	Code (Hexadecimal)	ASCII
Internal memory	00H	3030	80H	3830
PLC1 memory	11H	3131	91H	3931
PLC2 memory	12H	3132	92H	3932
PLC3 memory	13H	3133	93H	3933
PLC4 memory	14H	3134	94H	3934
PLC5 memory	15H	3135	95H	3935
PLC6 memory	16H	3136	96H	3936
PLC7 memory	17H	3137	97H	3937
PLC8 memory	18H	3138	98H	3938
Memory card	02H	3032	-	-

- Type

	Type	Code (Hexadecimal)	ASCII
Internal memory	\$u (user memory)	00H	3030
	\$s (system memory)	01H	3031
	\$L (non-volatile word memory)	02H	3032
	\$LD (non-volatile double-word memory)	03H	3033
	\$T (temporary user memory)	04H	3034
	\$P (memory for 8-way communication)	05H	3035
PLC1-to-8 memory	Depends on the PLC to be used. Set [TYPE No.] of the memory used for each device.		

- Address

Specify the memory address to be accessed.

- Expansion code

When accessing to the memory shown below, set the expansion code in addition to the type and address.

Model	Expansion Code
\$P	PLC 1 to 8
Fuji Electric PLC	File No. of the MICREX-F series, CPU No. of MICREX-SX series
JTEKT PLC	PRG No.
MITSUBISHI ELECTRIC PLC	Unit No. of SPU memory
OMRON PLC	Bank No.
SHARP PLC	File No. of Fn memory
Yokogawa Electric PLC	CPU No.

* If there is no need to set the expansion code, set "00" (= 3030 in the ASCII code).

- Port number

Set the port number used for 1 : n connection (multi-drop)

For 1 : 1 connection or n:1 connection (multi-link), the port number setting is not used. Alternatively, set "00" (= 3030 in the ASCII code).

- File number

Specify the file number set in the [Memory Card Setting] dialog of the V-SFT editor.

- Record number

Specify the record number set in the [Memory Card Setting] dialog of the V-SFT editor.

- System reserved

Enter "0" (= 30 in the ASCII code) for the number of bytes.

The number of bytes for "system reserved" varies depending on the model.

Example:

Model	Bytes	Code (Hexadecimal)	ASCII
TS internal memory	10	0000000000H	30303030303030303030

Sum Check Code (SUM): 2 Bytes

Data is added up (SUM), and the lower one byte (8 bits) of the sum is converted into a two-digit ASCII code (hexadecimal).

A sum check code is shown below.

Example: Transmission mode: without CR/LF, with sum check

Command: 20 (data read)

Address: 10 words from \$u1000 (03E8H)

When reading, a sum check will be performed as shown below.

STX	Port No.	Command	Read words	Memory model	Memory type	Address	System reserved	ETX	SUM
02H	30H31H	20H	0AH	00H	00H	03E8H	0 0 0 0 0 0 0 0 0H	03H	42H39H

02H + 30H + 31H + 32H + 30H + 30H + 41H + 30H + 30H + 30H + 30H + 30H + 33H + 45H + 38H

+ 30H + 30H + 30H + 30H + 30H + 30H + 30H + 30H + 30H + 30H + 03H = 4B9H

Response Code: 2 Bytes

“ACK” code is received at normal termination, and “NAK” code at abnormal termination. The following table shows the details of each code.

Code		Contents
ACK	00H	Normal termination
NAK	02H	Overrun/Framing error An overrun or framing error is detected in the received data. Send the command again.
	03H	Parity error A parity error is detected in the received data. Send the command again.
	04H	Sum check error A sum error occurs with the received data.
	06H	Count error The memory read/write count is “0”.
	0FH	ETX error No ETX code is found.
	11H	Character error A character not used in the received data is found (other than 0 to F). Check the character and send the command again.
	12H	Command error An invalid command is given.
	13H	Memory setting error The address or device number is invalid.

59.2 Modbus RTU Slave Communication

For details on Modbus RTU slave communication, refer to the Modbus Slave Communication Specifications manual provided separately.

59.3 Modbus TCP/IP Slave Communication

For details on Modbus TCP/IP slave communication, refer to the Modbus Slave Communication Specifications manual provided separately.

MEMO

Please use this page freely.

60. Universal Serial Communication

- 60.1 Overview
- 60.2 Wiring Diagrams
- 60.3 Device Connection Setting
- 60.4 Standard Type Protocol
- 60.5 Memory Map

60.1 Overview

Overview of Communication

- As shown in the diagram below, when a general-purpose computer communicates with the TS series, the general-purpose computer acts as the host and the TS series acts as the slave.
- Switch, lamp, data display, etc., are allocated within the internal user memory (\$u0 to 32767). Assign memory addresses for system, lamp, data display, and mode within this range.
- When a screen number is specified from the host, a write action takes place to the internal memory address specified for the screen. When a screen is changed internally by a switch, etc., the changed screen number is read, and written in the internal memory address specified for the screen.

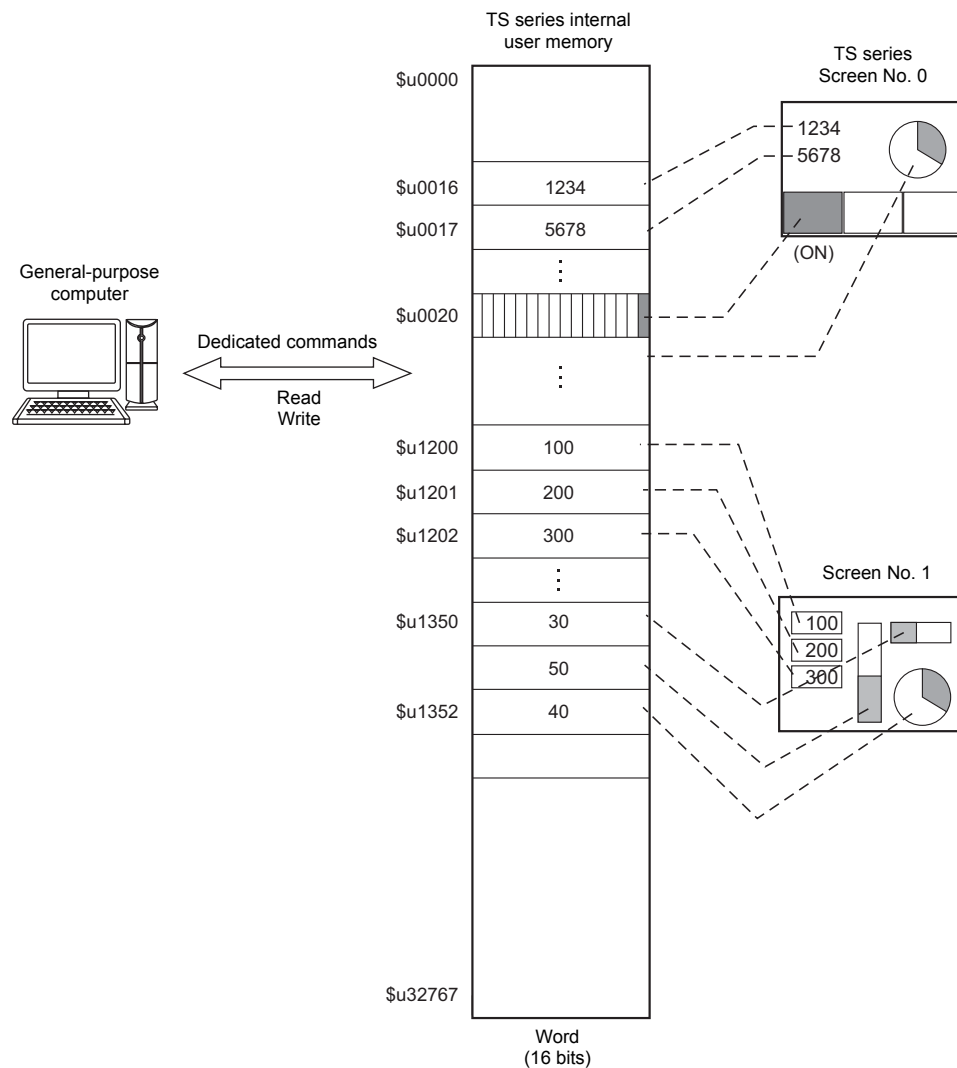

Differences between Connecting to General-purpose Computer and Connecting to PLC

- Input format (code)
The input format used for screen number, block number, message number, etc, is fixed in [DEC].
- Write area
When connecting to the PLC, only the three words shaded in the diagram below are used, but when connecting to a general-purpose computer, all 16 words shown below are used.

Address	Name	Contents
n + 0	CFMDAT	Sub command/data
n + 1	SCRN_COM	Screen status
n + 2	SCRN_No	Displayed screen
n + 3	SW0	No. 0 switch data
n + 4	SW1	No. 1 switch data
n + 5	ENT0	Entry information 0
n + 6	ENT1	Entry information 1
n + 7	ENT2	Entry information 2
n + 8	GREPNS	Global response
n + 9 • • n + 15		Reserved (7 words)

System Configuration

1 : 1 connection

- The transmission distance available via RS-232C is 15 m and RS-422/485 is 500 m at the maximum.
 - It is possible to use an interrupt* when connecting a computer to a TS series in a 1 : 1 connection.
- * For RS-485 (2-wire connection), interrupts cannot be used. For details on interrupts, see page 60-26.

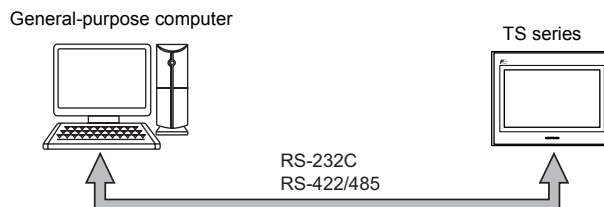

1 : n connection

- 1 : n connection is available via RS-422/485. A maximum of 32 TS series units can be connected.
- The transmission distance available is 500 m at the maximum.
- For 1 : n connection, interrupts cannot be used.

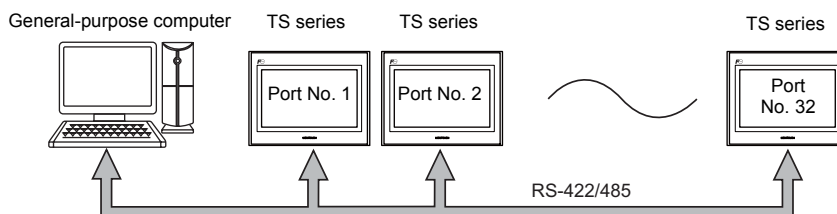

60.2 Wiring Diagrams

When Connected at COM1:

RS-422

1 : 1 connection

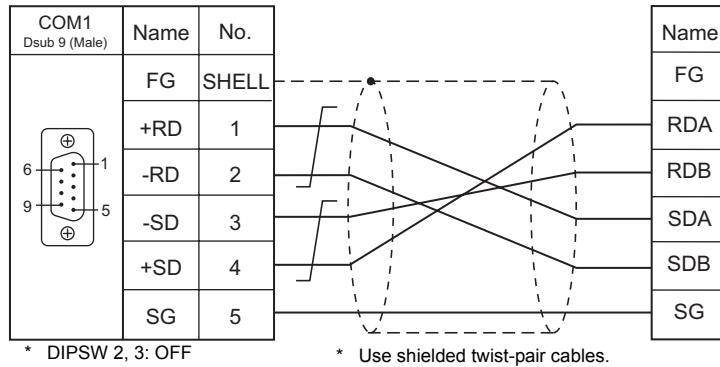

1 : n connection

- DIPSW No. 2, 3: OFF (COM1 RS-422: 4-wire connection)
- DIPSW No. 6, 7: Terminating resistance setting

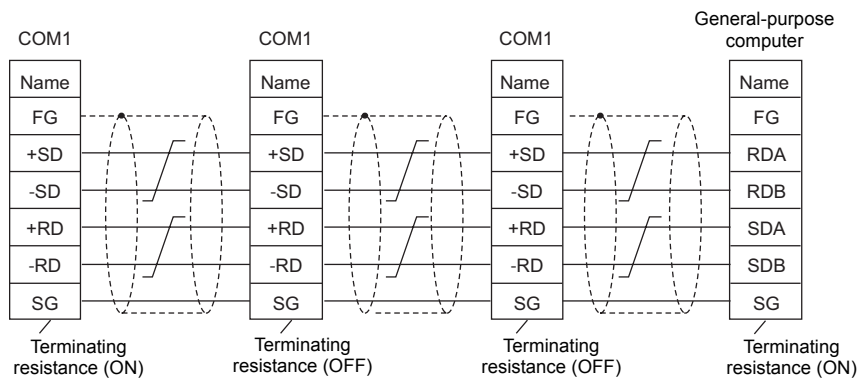

RS-485

1 : 1 connection

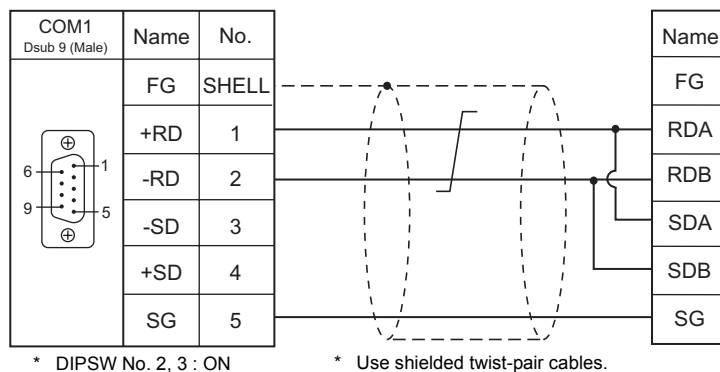

1 : n connection

- DIPSW No. 2, 3: ON (COM1 RS-485: 2-wire connection)
- DIPSW No. 6, 7: Terminating resistance setting

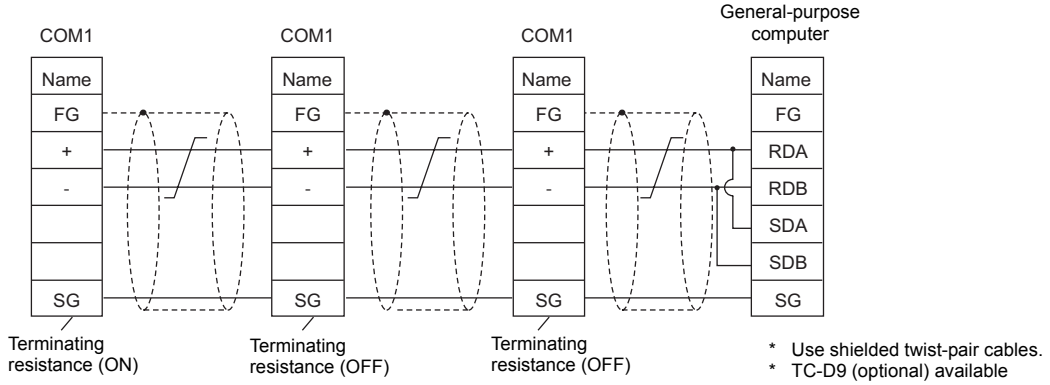

When Connected at COM2:

RS-232C

Without flow control

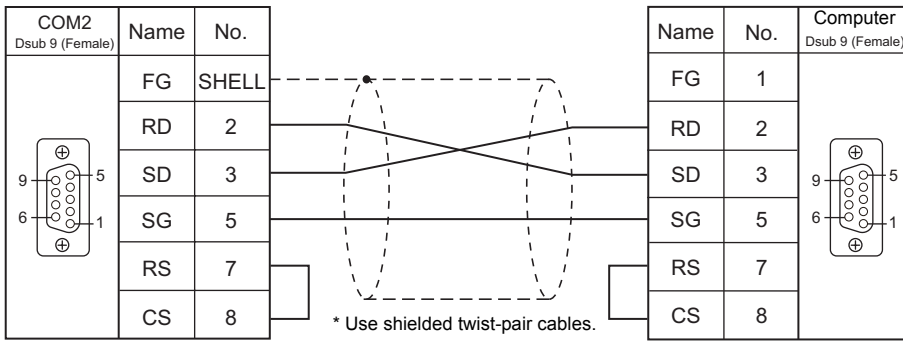

With flow control

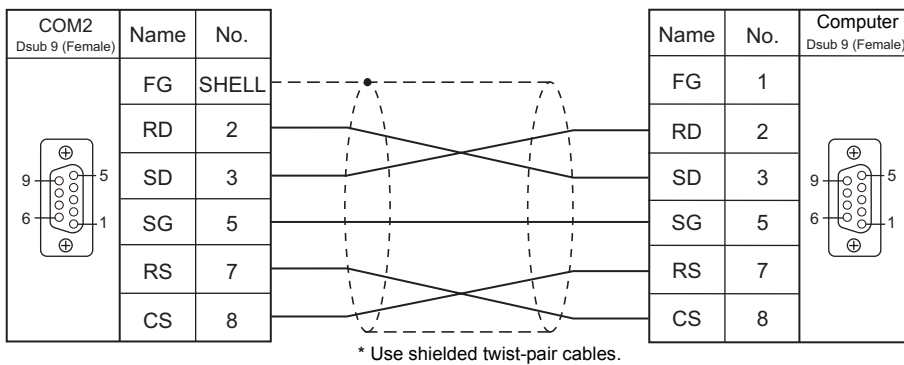

When Connected at COM3:

RS-485

1 : 1 connection

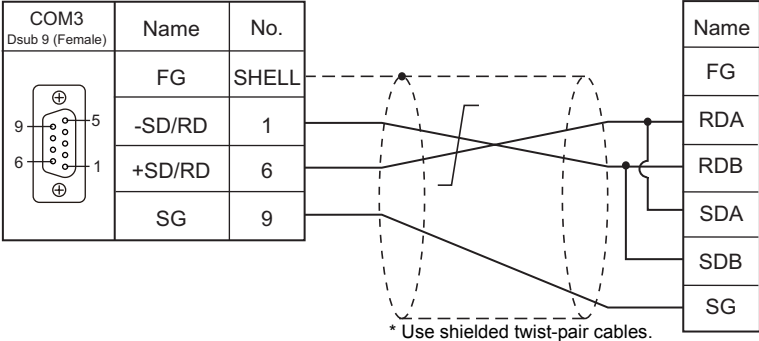

1 : n connection

- DIPSW No. 8: Terminating resistance setting

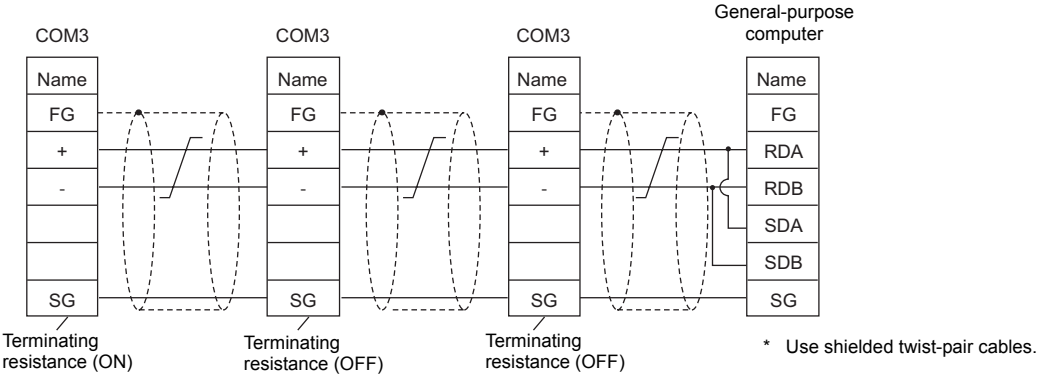

60.3 Device Connection Setting

PLC1

Make settings of universal serial communication for the logical port PLC1. When universal serial communication is set for PLC1, it can also be set for PLC2 to PLC8.

Device Selection

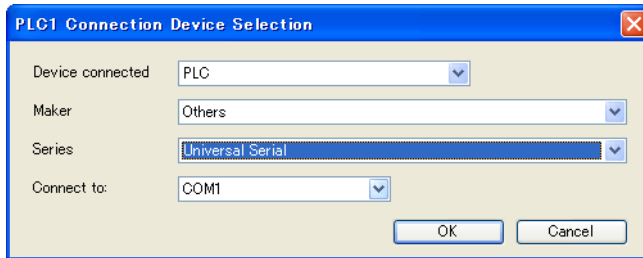

Communication Setting

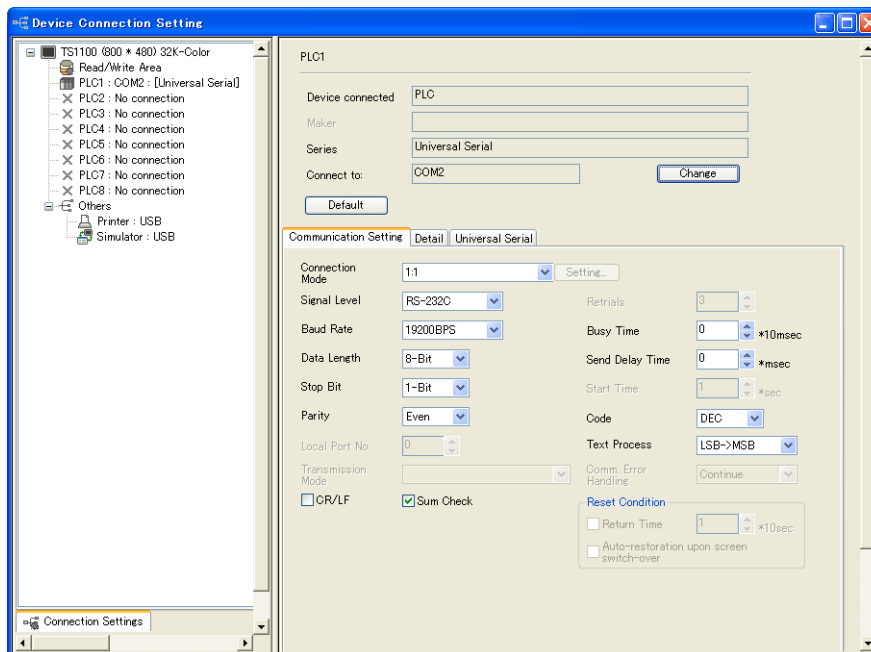

Connection Mode	Set the connection method for the TS series and host. 1 : 1: Select it when connecting one TS series unit to one host. 1 : n: Select it when connecting multiple TS series units to one host.
Signal Level	Set the signal level used for communication between the host and the TS series. RS-232C / RS-422/485
Baud Rate	Set the communication speed between the host and the TS series. 4800 / 9600 / 19200 / 38400 / 57600 / 76800 / 115K bps
Data Length	8 bits (fixed)
Stop Bit	Select a stop bit. 1 bit / 2 bits
Parity	Select an option for parity bit. None / Odd / Even
Target Port No.	This option is valid when 1 : n connection is used. Set the port number of the TS series.
CR/LF	Set whether or not to add a CR/LF code at the end of transmission data.
Sum Check	Set whether or not to add a sum check code at the end of transmission data.
Busy Time	For details, see page 60-18.
Send Delay Time	Set the time for TS series to send a response to a host after receiving a command from a host.
Code	DEC (fixed)

Text Process	When using text process, choose either [LSB → MSB] or [MSB → LSB] in order to make arrangements for the order of the first and the second bytes in one word.											
	<div style="display: flex; justify-content: space-around; align-items: center;"> <div style="text-align: center;"> <p>[LSB → MSB]</p> <table border="1" style="margin: auto;"> <tr> <td style="width: 50px; text-align: center;">15</td> <td style="width: 50px; text-align: center;">0</td> </tr> <tr> <td style="text-align: center;">MSB</td> <td style="text-align: center;">LSB</td> </tr> <tr> <td style="text-align: center;">2nd byte</td> <td style="text-align: center;">1st byte</td> </tr> </table> </div> <div style="text-align: center;"> <p>[MSB → LSB]</p> <table border="1" style="margin: auto;"> <tr> <td style="width: 50px; text-align: center;">15</td> <td style="width: 50px; text-align: center;">0</td> </tr> <tr> <td style="text-align: center;">MSB</td> <td style="text-align: center;">LSB</td> </tr> <tr> <td style="text-align: center;">1st byte</td> <td style="text-align: center;">2nd byte</td> </tr> </table> </div> </div>	15	0	MSB	LSB	2nd byte	1st byte	15	0	MSB	LSB	1st byte
15	0											
MSB	LSB											
2nd byte	1st byte											
15	0											
MSB	LSB											
1st byte	2nd byte											

Universal Serial

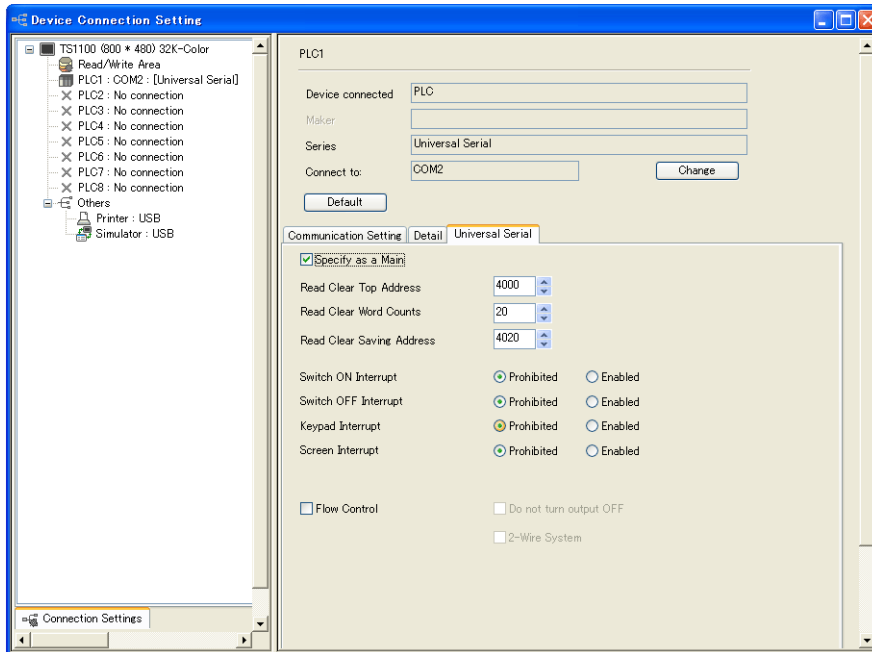

Read Clear Top Address ^{*2}	Set the top address number of the read clear area. The read clear area is the starting area from which the TS series clears data that was previously read. Due to the fact that it is cleared to "0", once this area is read, the data remains at "0" even if you attempt to read again when a read response error occurs.
Read Clear Word Counts ^{*2}	Set the number of words that will be used for clearing the read area.
Read Clear Saving ^{*2}	Set the top address for the read clear backup area. The area size will be the same as the previously described read clear area. The number of words written in the read clear backup area are the same as the number specified for the read clear area.
Switch ON Interrupt ^{*1}	Select whether or not to enable or disable an interrupt when the switch changes from OFF to ON.
Switch OFF Interrupt ^{*1}	Select whether or not to enable or disable an interrupt when the switch changes from ON to OFF.
Keypad Interrupt ^{*1}	Select whether or not to enable or disable an interrupt when the switch on the keypad or the ENT switch on the keyboard is pressed and it changes from OFF to ON.
Screen Interrupt ^{*1}	Select whether or not to enable or disable an interrupt when the screen change switch is pressed.
<input type="checkbox"/> Flow Control	This option is valid only for 1 : 1 communication via RS-232C using CN1. Check this box when disabling an interrupt from the TS series (e.g. when the host cannot receive interrupt data). When this box is checked, the action shown below takes place. <ul style="list-style-type: none"> Interrupt enabled when CS (pin 8) on the TS series side is ON Interrupt disabled when CS (pin 8) on the TS series side is OFF When CS is ON, interruption information stored by then is output in succession. (Interruption information for 3 times can be stored at the most.)
<input type="checkbox"/> Do not turn output OFF	This option is valid only for 1 : 1 communication via RS-422/485 using four-wire. Normally, TS series uses the same cables to send or receive data. For this reason, send output remains OFF (High impedance) except for sending signals from TS series. However, depending on the host specifications, send output OFF operation from the TS series is not required. In this case, check <input type="checkbox"/> Do not turn output OFF.
<input type="checkbox"/> 2-Wire System	This option is valid only for 1 : 1 communication with RS-422/485 using four-wire. When this box is checked, interrupt is disabled.

*1 Interrupt settings can be changed from the host using the [WI] command during communication. For details on interruption, see "60.4.4 Interrupt (ENQ)".

*2 Read clear and read clear backup action
 The action that occurs when a read command from the host tries to access to the read clear area is shown in the following diagram.
 Backup data of the system memory write area is allocated following the read clear backup area.

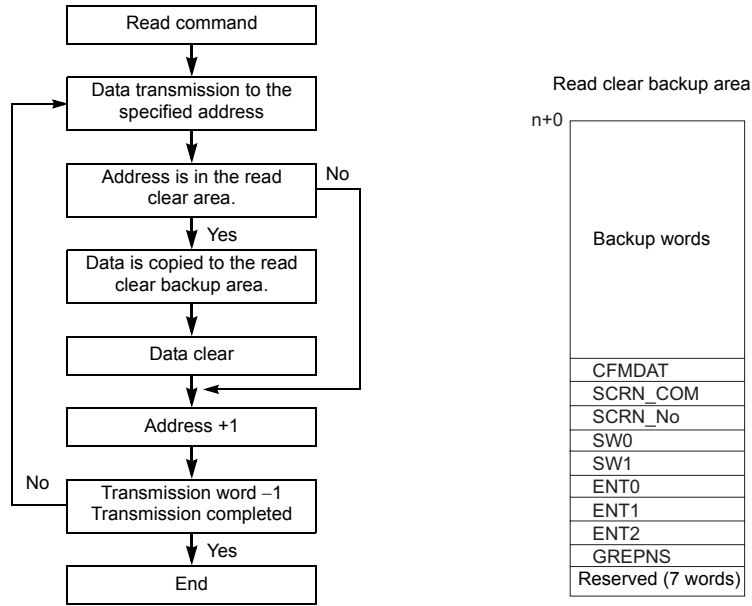

Read/Write Area

Read/Write Area

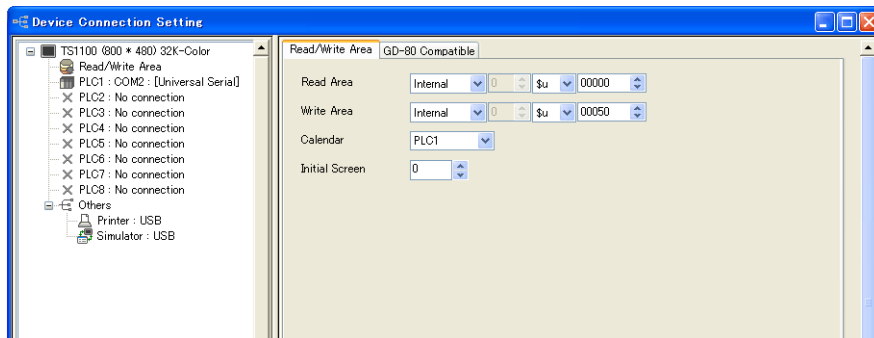

Read area

This memory area is necessary to change the screen display status by giving a command from the host. Be sure to set the \$u memory. Address allocation is shown in the table below. For more information, see "1.5.2 Read/Write Area" (page 1-27).

Address	Name	Contents
n + 0	RCV DAT	Sub command/data
n + 1	SCRN_COM	Screen status command
n + 2	SCRN_No	External screen command

Write area

This memory area is used to store information regarding screen number, overlap display, and entry mode when the screen display status is changed by a command received from the host. Be sure to set the \$u memory. Address allocation is shown in the table below.

Address	Name	Contents
n + 0	CFM DAT	Sub command/data
n + 1	SCRN_COM	Screen status
n + 2	SCRN_No	Displayed screen
n + 3	SW0	No. 0 switch data
n + 4	SW1	No. 1 switch data
n + 5	ENT0	Entry information 0
n + 6	ENT1	Entry information 1
n + 7	ENT2	Entry information 2
n + 8	GREPNS	Global response
n + 9 : n + 15		Reserved (7 words)

- n + 0 to n + 2
For details, see "1.5.2 Read/Write Area" (page 1-27).
- n + 3 (SW0) switch data No. 0, n + 4 (SW1) switch data No. 1
When the switch, for which [Output Action] is set to [Momentary/Momentary W] and [Output Memory] is set in location from \$s0080 to 0095, is pressed, the status and the number of the switch is stored.

n + 3, n + 4 (SW0/SW1)

15	14	13	12	11	10	09	08	07	06	05	04	03	02	01	00
	0	0	0	0	0	0	0								

└─ Switch status
 0: OFF
 1: ON

└─ Switch number

For the relationship between the switch output memory and the switch number, see page 60-30.

- n + 5 (ENT0) entry information 0, n + 6 (ENT1) entry information 1
The same contents as n + 0 and n + 1 of the [Info. Output Memory] that is set in the entry mode are written. Write operation occurs when the key whose function is set to "Write" is pressed in the entry mode. When the entry selection has changed, write operation will not occur. When (n + 5) entry information 0 is read by the host, writing completed bit (bit 15) is reset. Data is written in the backup (escape) area before it is read. (See page 60-8.)

- n + 7 (ENT2) entry information 2

The entry mode window number where a write operation was executed is written.

The relationship between the window number and base and the window number and overlap is shown in the following table.

Window No.	Contents
0	Base entry mode
1	Overlap 0 entry mode
2	Overlap 1 entry mode
3	Overlap 2 entry mode

- In case of using the entry mode for the table data display

The line number and the column number will be output to the address n + 1 and the block number to the address n + 2 of the "Info. Output Memory," when the bit No. 12 of "Command Memory" in the [Entry] dialog is ON [1]. In only this case, therefore, the window number cannot be referred because the block number is output to the address n + 7 (ENT2) of the write area.

- n + 8 (GREPNS) global response

A response is written when a global port number is used in 1 : n communication. The contents of a response are shown in the following table. For details on the global port number, see page 60-16.

Memory Contents	Contents
0000	Global command not received
0100	ACK
Others	Identical to NAK code (see page 60-17).

- n + 9 to n + 15
System reserved

Calendar

Select a device from which the calendar data is read without using the TS series' built-in clock. For more information on the built-in clock, refer to the V8 Series Reference Manual.

- PLC1 to 8

Calendar data is read from the selected device.

The calendar data will be updated when:

- The power is turned on.
- STOP → RUN
- The date changes.
- At the leading edge of a bit (0 → 1) in the calendar memory in the reading area

Initial screen

Set the number of the screen to be displayed when power to the TS series is turned on.

GD-80 Compatible

This setting is not valid because the GD-80 series cannot be used for universal serial communication.

60.4 Standard Type Protocol

60.4.1 Standard Type Protocol

The connection mode and transmission mode are set in the [Communication Setting] tab window under [System Setting]. The mode contents are as follows.

- Connection mode
 - 1 : 1: Select it when connecting one TS series unit to one host.
 - 1 : n: Select it when connecting multiple TS series units to one host. A maximum of 32 units can be connected. (Multi-drop specifications)
- Transmission mode

There are four transmission modes, depending on whether or not a sum check or CR/LF code is attached to the end of transmission and received data, as shown below.

Transmission Mode	Sum Check	CR/LF
1	Not provided	Not provided
2	Provided	Not provided
3	Not provided	Provided
4	Provided	Provided

Connection (1 : 1), Transmission Mode (with Sum Check)

This protocol is used when one host communicates with one TS series unit (1 : 1).

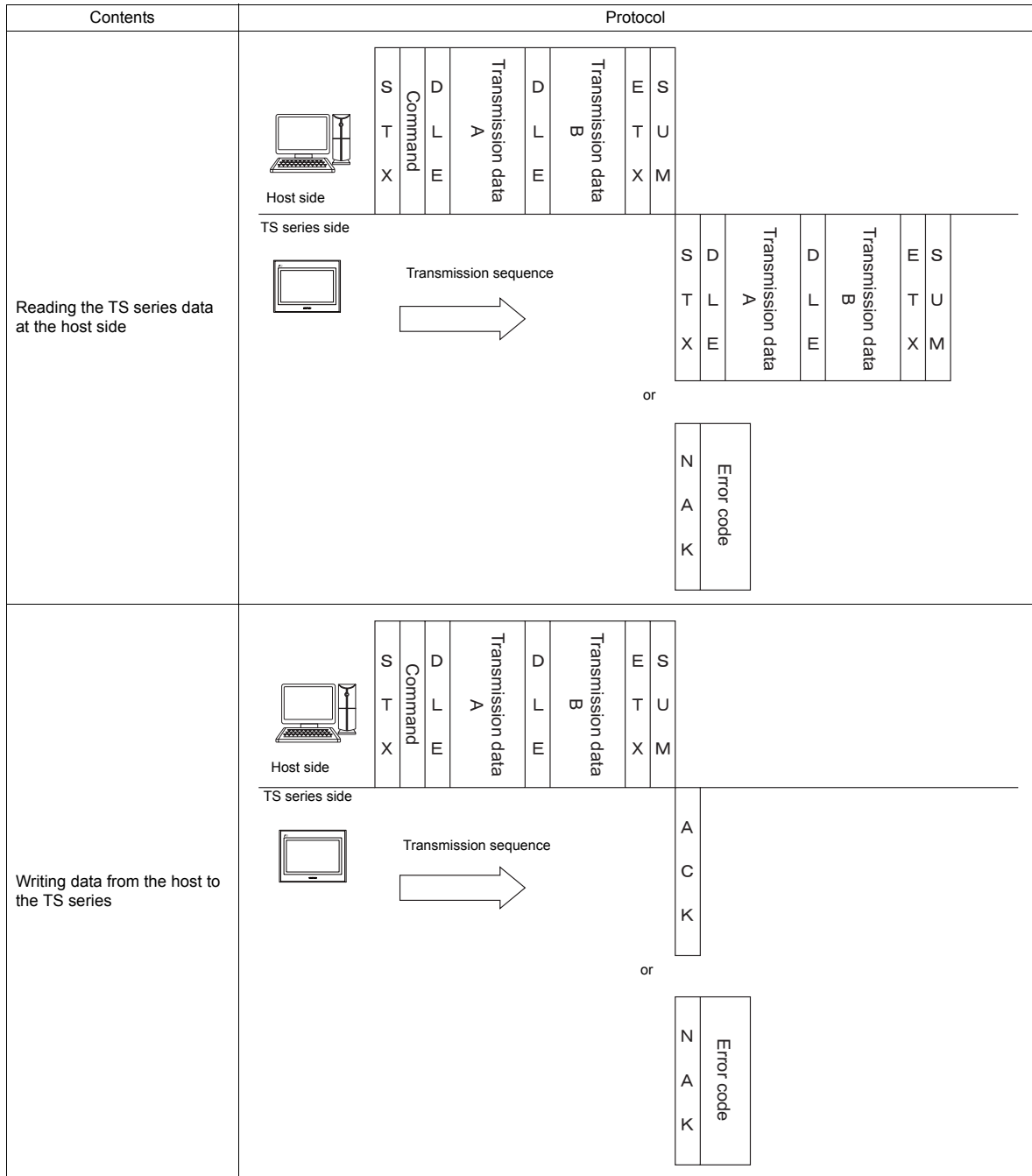

- When 1 : 1 connection is used, an interrupt can be used. For more information, see page 60-26.

Connection (1 : 1), Transmission Mode (with Sum Check and CR/LF)

This protocol is used when one host communicates with one TS series unit (1 : 1).

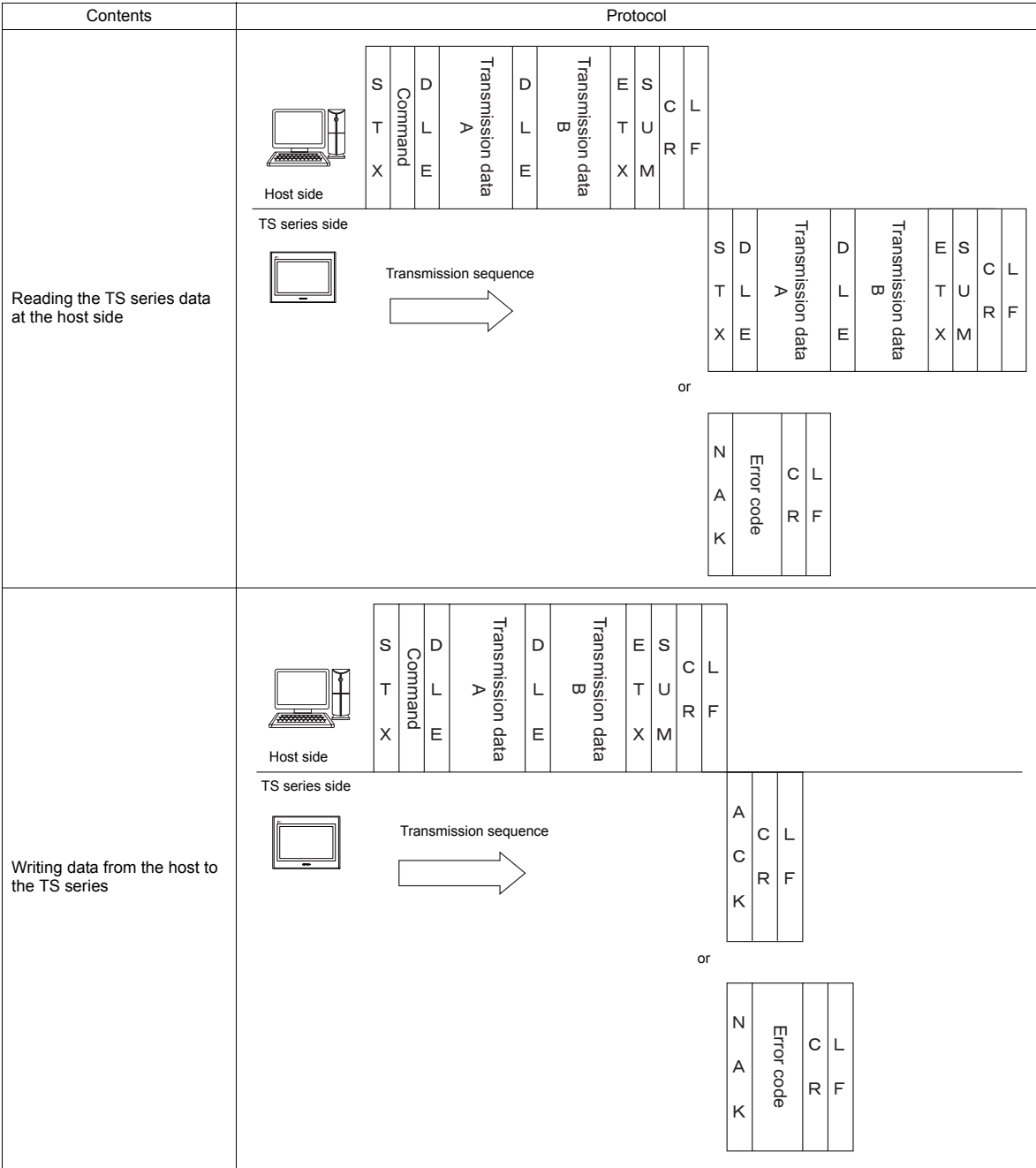

- When 1 : 1 connection is used, an interrupt can be used. For more information, see page 60-26.

Connection (1 : n), Transmission Mode (with Sum Check)

It is possible to connect as many as 32 TS series units to one host.
 (For information on the global command, see page 60-19.)

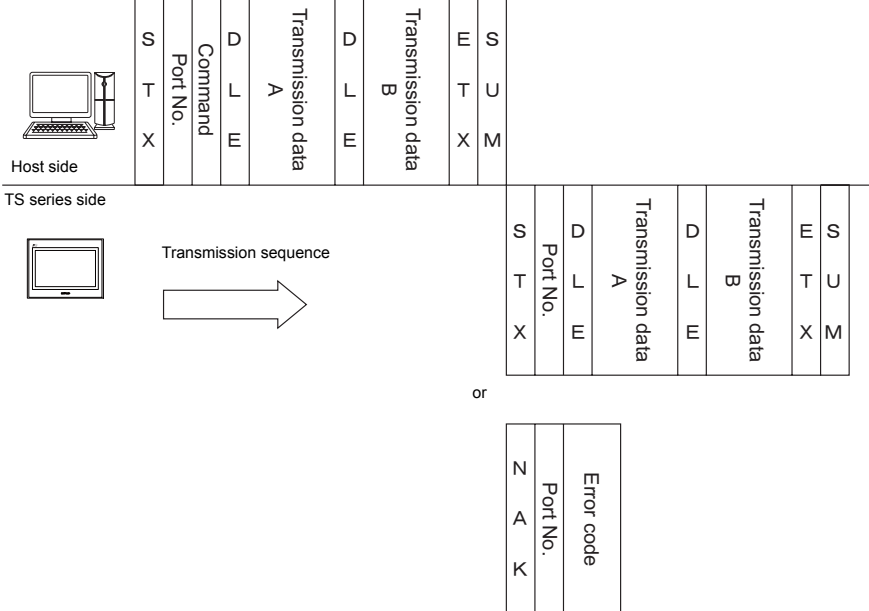
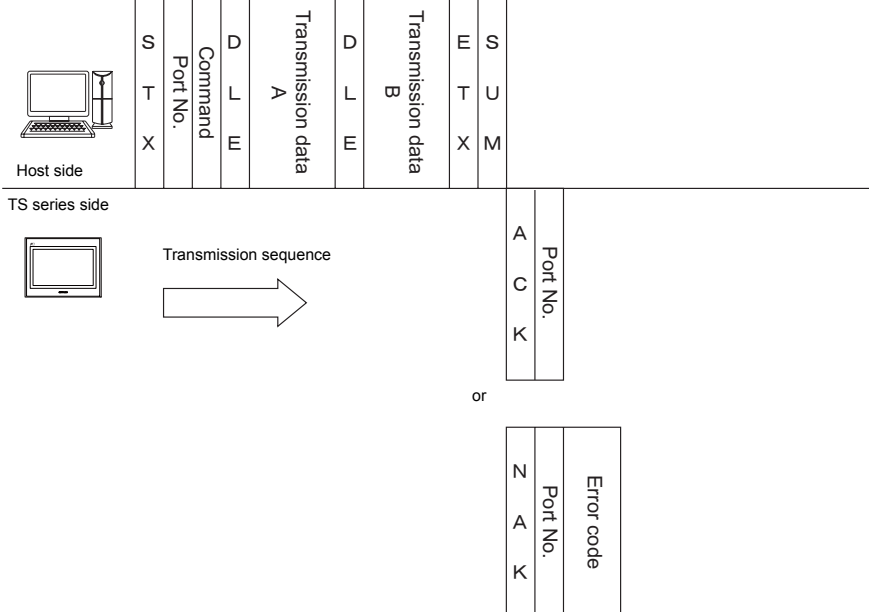
Contents	Protocol
<p>Reading the TS series data at the host side</p>	 <p>Host side</p> <p>TS series side</p> <p>Transmission sequence</p> <p>or</p> <p>Error code</p>
<p>Writing data from the host to the TS series</p>	 <p>Host side</p> <p>TS series side</p> <p>Transmission sequence</p> <p>or</p> <p>Error code</p>

Connection (1 : n), Transmission Mode (with Sum Check and CR/LF)

It is possible to connect as many as 32 TS series units to one host.
 (For information on the global command, see page 60-19.)

Contents	Protocol
<p>Reading the TS series data at the host side</p>	<p>Host side</p> <p>TS series side</p> <p>Transmission sequence</p> <p>or</p>
<p>Writing data from the host to the TS series</p>	<p>Host side</p> <p>TS series side</p> <p>Transmission sequence</p> <p>or</p>

60.4.2 Protocol Contents

Transmission Control Code

The transmission control codes are shown in the table below.

Signal Name	Code (Hexadecimal)	Contents
STX	02H	Start of transmission block
ETX	03H	End of transmission block
ENQ	05H	Interrupt
ACK	06H	Positive acknowledge
CR	0DH	Carriage return
DLE	10H	Change contents within a block
NAK	15H	Negative acknowledge
LF	0AH	Line feed

Port Number

Port numbers can be set for connection mode "1 : n".

They are used so that the host computer can identify each TS series for access.

The data range is from 00H to 1FH (0 to 31) and is converted into a two-digit ASCII code (HEX) before use. Set port numbers of the TS series at [Local Port No.] in the [Communication Setting] tab window.

Global port number (FFH)

When the global port number [FFH] is set, commands are sent to all TS series units at one time.

Commands for which global port numbers are active are shown below. If commands other than these are used, a command error will occur.

Signal Name	Name	Contents
WM	Write	Write data memory
WC	Write CHR	Write data memory as characters

Responses to global port numbers are not transmitted to the host. However, responses are written in write area n + 8.

Memory Contents	Contents
0000H	Global command not received
0100H	ACK
Others	Identical to NAK code (see page 60-17.)

Command

Available commands are shown below. The details on commands are described on pages shown at "Refer to:".

Signal Name	Name	Contents	Refer to:
RM	Read	Read data memory	page 60-20
WM	Write	Write data memory (512 words maximum)	page 60-22
TR	Retry	Retry when NAK [01] is BUSY	page 60-23
WI	Interrupt Setting	Allow interrupt (Connection mode 1 : 1)	page 60-24
RI	Read interrupt status	Read interrupt setting status (Connection mode 1 : 1)	page 60-25
RC	Read CHR	Read data memory as characters	page 60-19
WC	Write CHR	Write data memory as characters (1024 bytes maximum)	page 60-21

Sum Check Code (SUM)

Data is added up (SUM), and the lower one byte (8 bits) of the sum is converted into a two-digit ASCII code (HEX).

Example:

Transmission mode: without CR/LF, with sum check

The sum check code is added as shown below when data "3882" (OF2AH) is transmitted to the address "\$u1453" (05ADH) using the command [WM] (data writing).

STX	Command	DLE	Address	Count	Memory data	ETX	SUM
	"W" "M"		"0" "5" "A" "D"	"0" "0" "0" "1"	"0" "F" "2" "A"		"4" "D"
02H	57H 4DH	10H	30H 35H 41H 44H	30H 30H 30H 31H	30H 46H 32H 41H	03H	34H 44H

$$02H + 57H + 4DH + 10H + 30H + 35H + 41H + 44H + 30H + 30H + 30H + 31H + 30H + 46H + 32H + 41H + 03H = 34DH$$

* In the case of an interrupt, data from ENQ to ETX is subject to a sum check.

Error Codes

An error code is sent along with an NAK response as a two-digit ASCII code (HEX).

Error Codes	Contents
01H	The TS series is currently engaged in display processing. The received command is on standby due to display processing. Wait a few moments and re-transmit the command.
02H	Overrun/Framing error An overrun or framing error is detected in the received data. Send the command again.
03H	Parity error A parity error is detected in the received data. Send the command again.
04H	Sum check error A sum error occurs with the received data.
05H	Address error The address specified by the memory read/write command is incorrect. Check the address or counter and re-transmit the command.
06H	Count error The memory read/write count is "0".
07H	Screen error The data to be written in read area n + 2 (screen status command), as specified by a write command, is not registered on the screen. Check the screen number and re-transmit the data.
08H	Format error The number of DLEs is 0 or greater than 6.
09H	Received data over The number of write command data received from the host exceeded that of data shown below. • Write memory command = 512 words • Write CHR command = 1024 bytes
0BH	Retry command error When a retry command is received, there is no BUSY status (NAK [01]) command.
0FH	ETX error No ETX code is found.
10H	DLE error No DLE code is found.
11H	Character error A character not used in the received data is found (other than 0 to F). Check the character and send the command again.
12H	Command error An invalid command is given.

Response Time and BUSY

Response time varies depending on the type of command.

RM / RI / RC

These commands immediately send a response once receipt of data is complete. No NAK [01] (BUSY) signal is given.

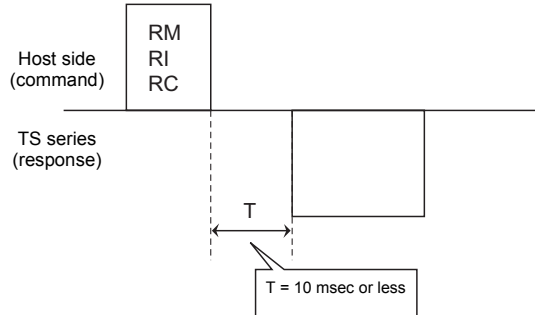

WM / TR / WI / WC

Once receipt of data is complete, these commands first check the display status. If the display status is found to be complete, a response is sent and a command is executed.

If the status is BUSY and the display is completed within the time set in [Busy Time], a response is sent.

If the display is not completed within the specified time, an NAK [01] (BUSY) signal is sent. In this case, it is necessary to retransmit the command.

When [Busy Time] is set as [0], the machine waits until the display is complete, and then a response is transmitted after a command is executed.

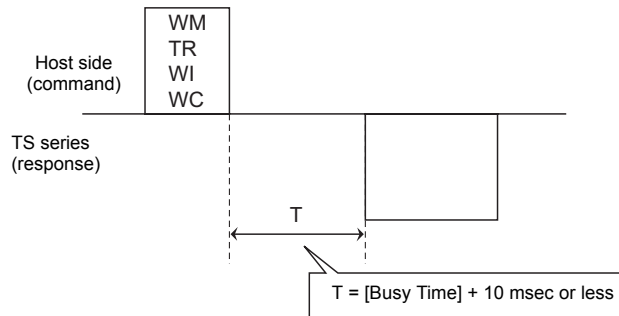

60.4.3 Command

RC: Read CHR

This command is used to read data memory as characters.

- * When character data is sent, 1 character (1 byte) is converted into a two-byte ASCII code and transmitted by the read memory command. When the read CHR command is given, character data is not converted into the ASCII code before transmission, and thus, the transmission time is decreased by approximately 1/2.

Details of read CHR

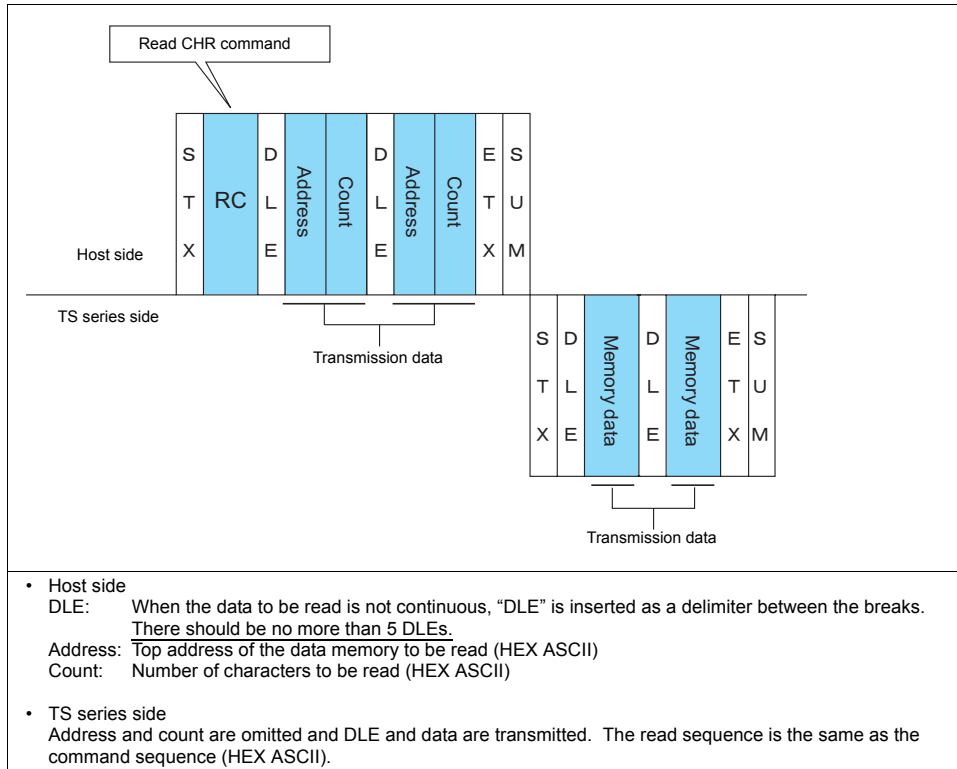

Example:

Call up 4 characters that are written at the top of the address \$u0020 (0014H).

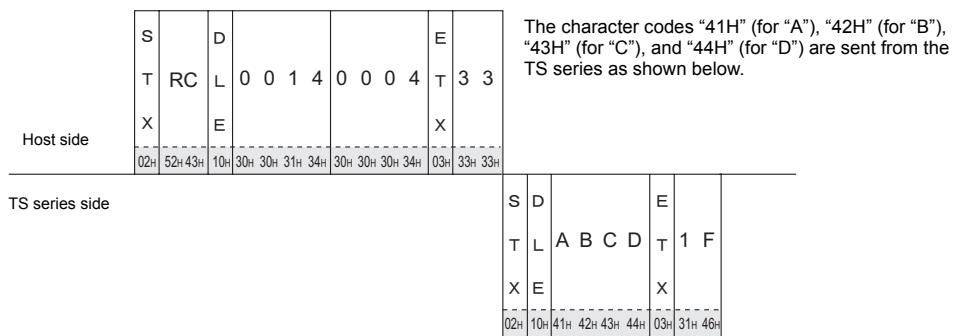

RM: Read Memory

This command is used to read data memory.

- * Communication speed is increased when you use the read CHR command to read characters.

Details of read memory

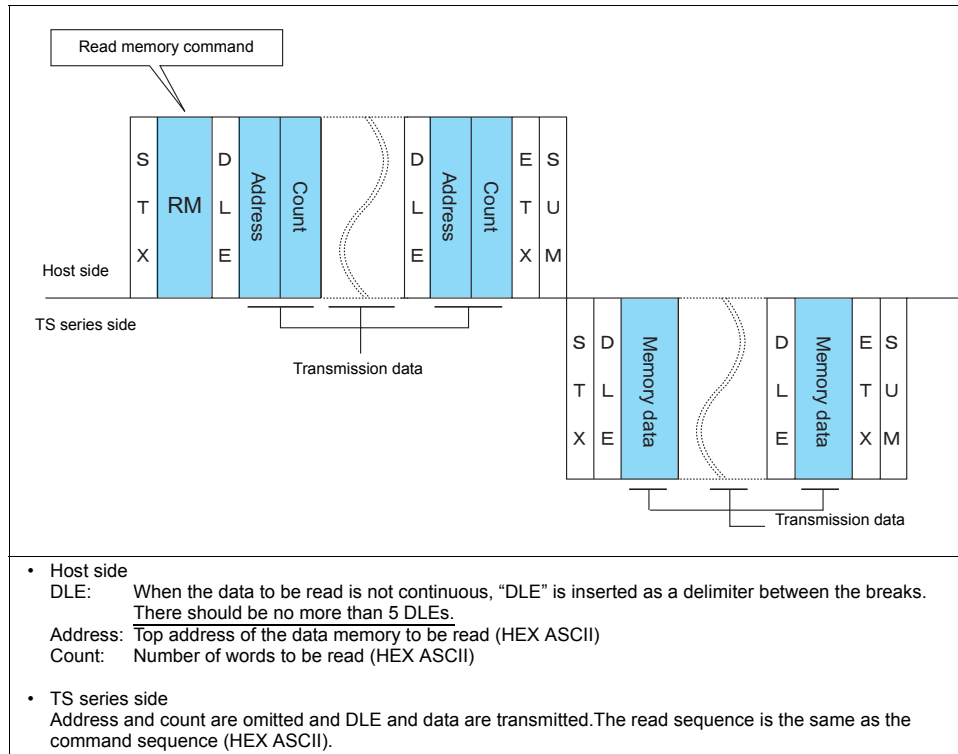

Example:

Read the double-word data "75,000" (DEC) contained in the address \$u0020 (0014H).

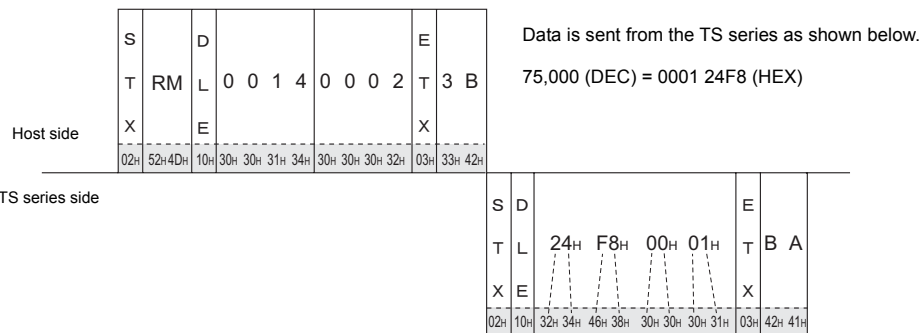

WC: Write CHR

This command is used to write data memory as characters.

- * When character data is sent, 1 character (1 byte) is converted into a two-byte ASCII code and transmitted by the write memory command. When the write CHR command is given, character data is not converted into the ASCII code before transmission, and thus, the transmission time is decreased by approximately 1/2. (Character codes from 00 to 1F cannot be used.)

Details of write CHR

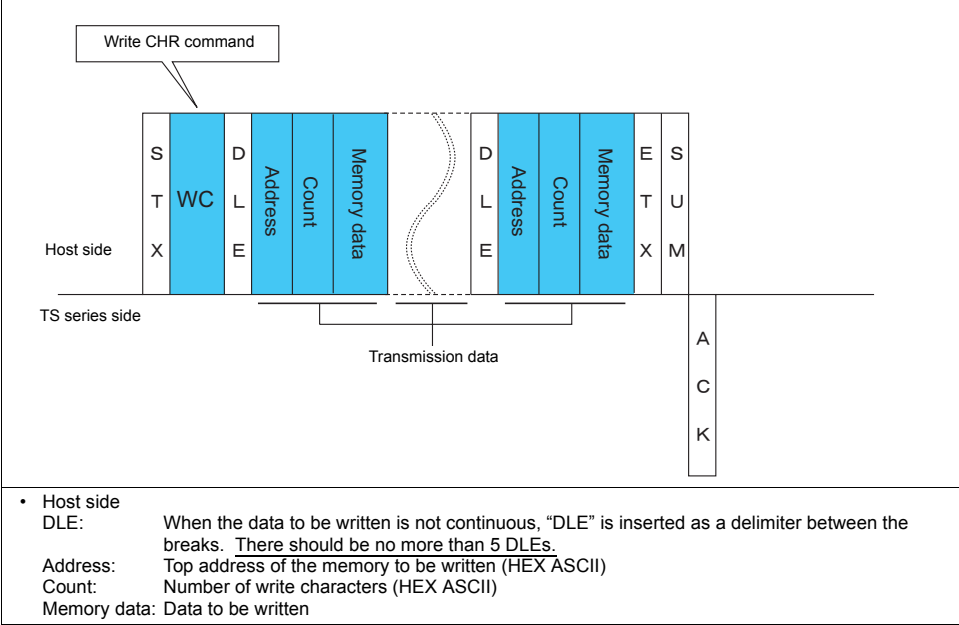

Example:

Send data to display the following characters on the TS series.
 \$u0100 (0064H), EF
 \$u0101 (0065H), GH
 \$u0102 (0066H), IJ
 \$u0103 (0067H), KL

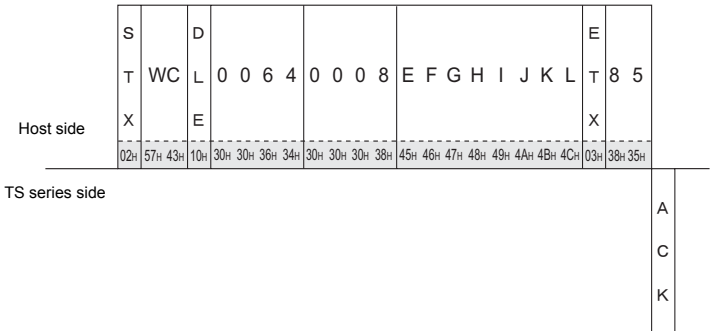

TR: Retry Command

This command is used to re-send a write command/write CHR command when an NAK error code [01] is returned.

Details of retry

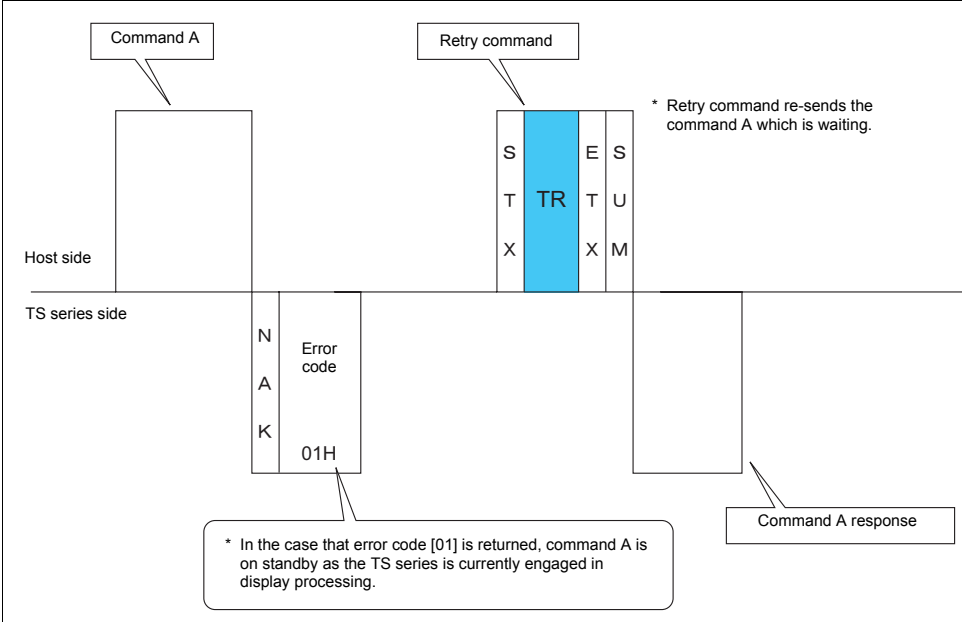

WI: Interrupt Setting Command

This command is used to send interrupt conditions. It can be used for 1 : 1 connection.

Details of interrupt setting command

- Host side
Data: Interrupt conditions is specified when the interrupt data bit is set. (HEX ASCII)

Interrupt conditions

07	06	05	04	03	02	01	00

0: Interrupt prohibited
1: Interrupt allowed

- Switch ON
- Switch OFF
- Keypad write & character entry
- Screen internal switching

Switch ON	Interrupt when the switch changes from OFF to ON Valid only when [Action] of the switch is [Normal], [Block], [+Block], [-Block] or [Mode]
Switch OFF	Interrupt when the switch changes from ON to OFF Valid only when [Action] of the switch is [Normal], [Block], [+Block], [-Block] or [Mode]
Keypad write	Interrupt when the [ENTER] switch on the keypad is pressed
Screen internal switching	Interrupt when the screen changes based on an internal switch

* Macro (OUT_ENQ): Interrupt enabled all the time

Example:

Interrupt settings are as shown below.

07	06	05	04	03	02	01	00
0	0	0	0	1	1	0	0

- Switch ON: disabled
- Switch OFF: disabled
- Keypad write & character entry: enabled
- Screen internal switching: enabled

S			E	
T	WI	0C	T	18
X			X	
02H 57H 49H 30H 43H 03H 31H 38H				

Host side

TS series side

A
C
K

RI: Interrupt Status Read Command

This command is used to read interrupt setting status. It can be used for 1 : 1 connection.

Details of interrupt status read command

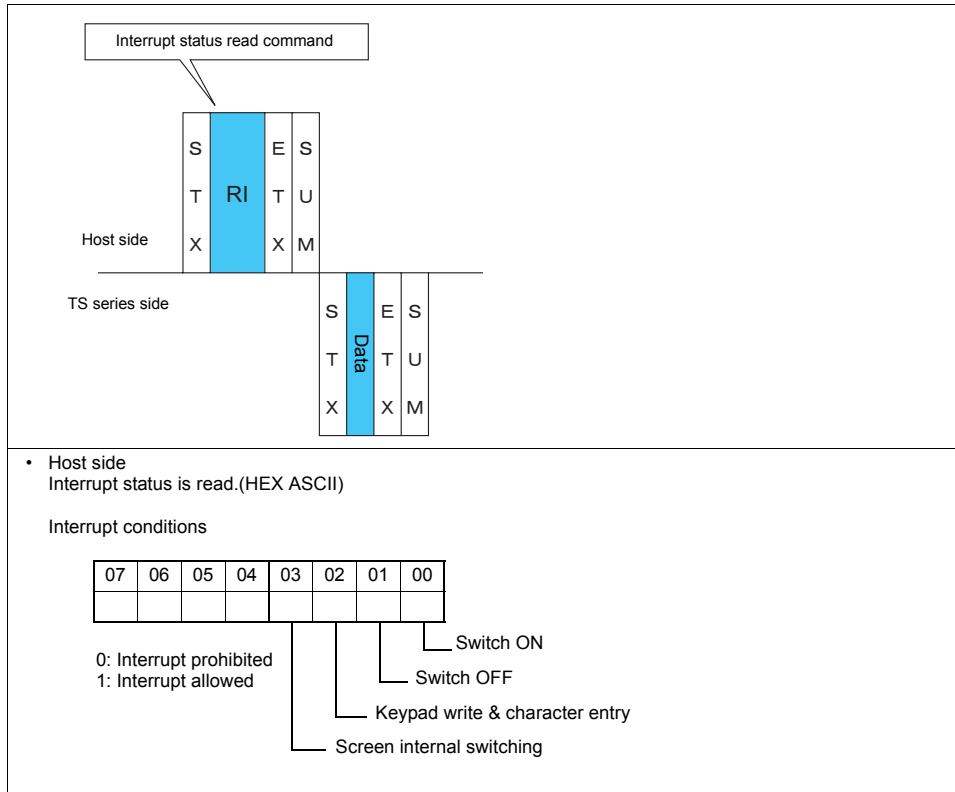

Example:

Interrupt status is read.

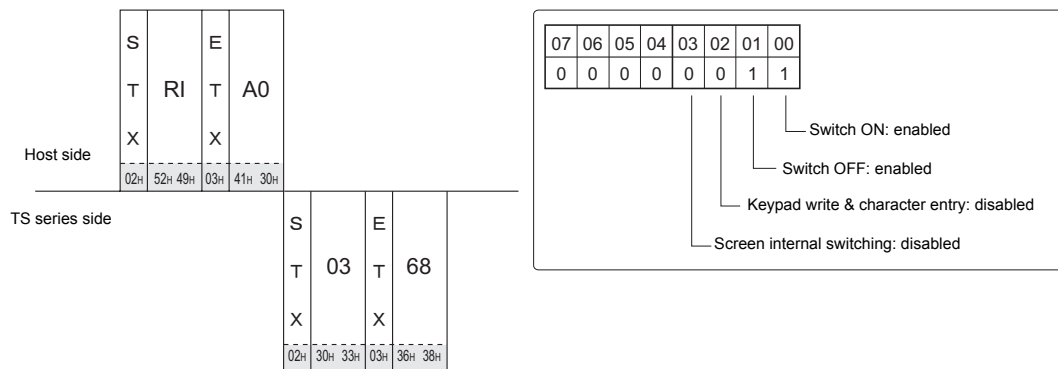

System Memory (\$s)

2048 words are available for system memory. System memory is memory that writes TS series action status when the TS series is currently displaying something. With this written information, it is possible to check overlap status, buffer area, printer, backlight, and slave station status in multi-drop connection mode. In the table below, a small part (\$s80 to 95) of system memory is extracted. For other memory addresses, refer to the Reference Manual.

* System memory cannot be read or written from the host computer.

Address \$s0080 to 95

Set [Output Memory] in location (\$s0080 to 95) of system memory, and select [Momentary] for [Output Action] of a switch. When the switch is pressed, output memory is set (0 → 1) and the corresponding switch number is written in system setting areas n + 3 and n + 4. (See page 60-9.)

The relationship between the output memory and the switch number is shown in the following diagram. For details about the output of a switch, see page 60-28.

Address	Contents																																
:																																	
\$s80	Universal serial switch output 0 Switch No. 0 to 15																																
	MSB																																
	<table border="1" style="width: 100%; text-align: center;"> <tr> <td>15</td><td>14</td><td>13</td><td>12</td><td>11</td><td>10</td><td>9</td><td>8</td><td>7</td><td>6</td><td>5</td><td>4</td><td>3</td><td>2</td><td>1</td><td>0</td> </tr> <tr> <td>No.</td><td>15</td><td>14</td><td>13</td><td>12</td><td>11</td><td>10</td><td>9</td><td>8</td><td>7</td><td>6</td><td>5</td><td>4</td><td>3</td><td>2</td><td>1</td><td>0</td> </tr> </table>	15	14	13	12	11	10	9	8	7	6	5	4	3	2	1	0	No.	15	14	13	12	11	10	9	8	7	6	5	4	3	2	1
15	14	13	12	11	10	9	8	7	6	5	4	3	2	1	0																		
No.	15	14	13	12	11	10	9	8	7	6	5	4	3	2	1	0																	
LSB																																	
\$s81	Universal serial switch output 1 Switch No. 16 to 31																																
	MSB																																
	<table border="1" style="width: 100%; text-align: center;"> <tr> <td>15</td><td>14</td><td>13</td><td>12</td><td>11</td><td>10</td><td>9</td><td>8</td><td>7</td><td>6</td><td>5</td><td>4</td><td>3</td><td>2</td><td>1</td><td>0</td> </tr> <tr> <td>No.</td><td>31</td><td>30</td><td>29</td><td>28</td><td>27</td><td>26</td><td>25</td><td>24</td><td>23</td><td>22</td><td>21</td><td>20</td><td>19</td><td>18</td><td>17</td><td>16</td> </tr> </table>	15	14	13	12	11	10	9	8	7	6	5	4	3	2	1	0	No.	31	30	29	28	27	26	25	24	23	22	21	20	19	18	17
15	14	13	12	11	10	9	8	7	6	5	4	3	2	1	0																		
No.	31	30	29	28	27	26	25	24	23	22	21	20	19	18	17	16																	
LSB																																	
\$s82	Universal serial switch output 2 Switch No. 32 to 47																																
	MSB																																
	<table border="1" style="width: 100%; text-align: center;"> <tr> <td>15</td><td>14</td><td>13</td><td>12</td><td>11</td><td>10</td><td>9</td><td>8</td><td>7</td><td>6</td><td>5</td><td>4</td><td>3</td><td>2</td><td>1</td><td>0</td> </tr> <tr> <td>No.</td><td>47</td><td>46</td><td>45</td><td>44</td><td>43</td><td>42</td><td>41</td><td>40</td><td>39</td><td>38</td><td>37</td><td>36</td><td>35</td><td>34</td><td>33</td><td>32</td> </tr> </table>	15	14	13	12	11	10	9	8	7	6	5	4	3	2	1	0	No.	47	46	45	44	43	42	41	40	39	38	37	36	35	34	33
15	14	13	12	11	10	9	8	7	6	5	4	3	2	1	0																		
No.	47	46	45	44	43	42	41	40	39	38	37	36	35	34	33	32																	
LSB																																	
\$s83	Universal serial switch output 3 Switch No. 48 to 63																																
	MSB																																
	<table border="1" style="width: 100%; text-align: center;"> <tr> <td>15</td><td>14</td><td>13</td><td>12</td><td>11</td><td>10</td><td>9</td><td>8</td><td>7</td><td>6</td><td>5</td><td>4</td><td>3</td><td>2</td><td>1</td><td>0</td> </tr> <tr> <td>No.</td><td>63</td><td>62</td><td>61</td><td>60</td><td>59</td><td>58</td><td>57</td><td>56</td><td>55</td><td>54</td><td>53</td><td>52</td><td>51</td><td>50</td><td>49</td><td>48</td> </tr> </table>	15	14	13	12	11	10	9	8	7	6	5	4	3	2	1	0	No.	63	62	61	60	59	58	57	56	55	54	53	52	51	50	49
15	14	13	12	11	10	9	8	7	6	5	4	3	2	1	0																		
No.	63	62	61	60	59	58	57	56	55	54	53	52	51	50	49	48																	
LSB																																	
\$s84	Universal serial switch output 4 Switch No. 64 to 79																																
	MSB																																
	<table border="1" style="width: 100%; text-align: center;"> <tr> <td>15</td><td>14</td><td>13</td><td>12</td><td>11</td><td>10</td><td>9</td><td>8</td><td>7</td><td>6</td><td>5</td><td>4</td><td>3</td><td>2</td><td>1</td><td>0</td> </tr> <tr> <td>No.</td><td>79</td><td>78</td><td>77</td><td>76</td><td>75</td><td>74</td><td>73</td><td>72</td><td>71</td><td>70</td><td>69</td><td>68</td><td>67</td><td>66</td><td>65</td><td>64</td> </tr> </table>	15	14	13	12	11	10	9	8	7	6	5	4	3	2	1	0	No.	79	78	77	76	75	74	73	72	71	70	69	68	67	66	65
15	14	13	12	11	10	9	8	7	6	5	4	3	2	1	0																		
No.	79	78	77	76	75	74	73	72	71	70	69	68	67	66	65	64																	
LSB																																	
\$s85	Universal serial switch output 5 Switch No. 80 to 95																																
	MSB																																
	<table border="1" style="width: 100%; text-align: center;"> <tr> <td>15</td><td>14</td><td>13</td><td>12</td><td>11</td><td>10</td><td>9</td><td>8</td><td>7</td><td>6</td><td>5</td><td>4</td><td>3</td><td>2</td><td>1</td><td>0</td> </tr> <tr> <td>No.</td><td>95</td><td>94</td><td>93</td><td>92</td><td>91</td><td>90</td><td>89</td><td>88</td><td>87</td><td>86</td><td>85</td><td>84</td><td>83</td><td>82</td><td>81</td><td>80</td> </tr> </table>	15	14	13	12	11	10	9	8	7	6	5	4	3	2	1	0	No.	95	94	93	92	91	90	89	88	87	86	85	84	83	82	81
15	14	13	12	11	10	9	8	7	6	5	4	3	2	1	0																		
No.	95	94	93	92	91	90	89	88	87	86	85	84	83	82	81	80																	
LSB																																	
\$s86	Universal serial switch output 6 Switch No. 96 to 111																																
	MSB																																
	<table border="1" style="width: 100%; text-align: center;"> <tr> <td>15</td><td>14</td><td>13</td><td>12</td><td>11</td><td>10</td><td>9</td><td>8</td><td>7</td><td>6</td><td>5</td><td>4</td><td>3</td><td>2</td><td>1</td><td>0</td> </tr> <tr> <td>No.</td><td>111</td><td>110</td><td>109</td><td>108</td><td>107</td><td>106</td><td>105</td><td>104</td><td>103</td><td>102</td><td>101</td><td>100</td><td>99</td><td>98</td><td>97</td><td>96</td> </tr> </table>	15	14	13	12	11	10	9	8	7	6	5	4	3	2	1	0	No.	111	110	109	108	107	106	105	104	103	102	101	100	99	98	97
15	14	13	12	11	10	9	8	7	6	5	4	3	2	1	0																		
No.	111	110	109	108	107	106	105	104	103	102	101	100	99	98	97	96																	
LSB																																	
\$s87	Universal serial switch output 7 Switch No. 112 to 127																																
	MSB																																
	<table border="1" style="width: 100%; text-align: center;"> <tr> <td>15</td><td>14</td><td>13</td><td>12</td><td>11</td><td>10</td><td>9</td><td>8</td><td>7</td><td>6</td><td>5</td><td>4</td><td>3</td><td>2</td><td>1</td><td>0</td> </tr> <tr> <td>No.</td><td>127</td><td>126</td><td>125</td><td>124</td><td>123</td><td>122</td><td>121</td><td>120</td><td>119</td><td>118</td><td>117</td><td>116</td><td>115</td><td>114</td><td>113</td><td>112</td> </tr> </table>	15	14	13	12	11	10	9	8	7	6	5	4	3	2	1	0	No.	127	126	125	124	123	122	121	120	119	118	117	116	115	114	113
15	14	13	12	11	10	9	8	7	6	5	4	3	2	1	0																		
No.	127	126	125	124	123	122	121	120	119	118	117	116	115	114	113	112																	
LSB																																	
\$s88	Universal serial switch output 8 Switch No. 128 to 143																																
	MSB																																
	<table border="1" style="width: 100%; text-align: center;"> <tr> <td>15</td><td>14</td><td>13</td><td>12</td><td>11</td><td>10</td><td>9</td><td>8</td><td>7</td><td>6</td><td>5</td><td>4</td><td>3</td><td>2</td><td>1</td><td>0</td> </tr> <tr> <td>No.</td><td>143</td><td>142</td><td>141</td><td>140</td><td>139</td><td>138</td><td>137</td><td>136</td><td>135</td><td>134</td><td>133</td><td>132</td><td>131</td><td>130</td><td>129</td><td>128</td> </tr> </table>	15	14	13	12	11	10	9	8	7	6	5	4	3	2	1	0	No.	143	142	141	140	139	138	137	136	135	134	133	132	131	130	129
15	14	13	12	11	10	9	8	7	6	5	4	3	2	1	0																		
No.	143	142	141	140	139	138	137	136	135	134	133	132	131	130	129	128																	
LSB																																	

Address	Contents															
\$s89	Universal serial switch output 9 Switch No. 144 to 159															
	MSB															LSB
	No.	15	14	13	12	11	10	9	8	7	6	5	4	3	2	1
	159	158	157	156	155	154	153	152	151	150	149	148	147	146	145	144
\$s90	Universal serial switch output 10 Switch No. 160 to 175															
	MSB															LSB
	No.	15	14	13	12	11	10	9	8	7	6	5	4	3	2	1
	175	174	173	172	171	170	169	168	167	166	165	164	163	162	161	160
\$s91	Universal serial switch output 11 Switch No. 176 to 191															
	MSB															LSB
	No.	15	14	13	12	11	10	9	8	7	6	5	4	3	2	1
	191	190	189	188	187	186	185	184	183	182	181	180	179	178	177	176
\$s92	Universal serial switch output 12 Switch No. 192 to 207															
	MSB															LSB
	No.	15	14	13	12	11	10	9	8	7	6	5	4	3	2	1
	207	206	205	204	203	202	201	200	199	198	197	196	195	194	193	192
\$s93	Universal serial switch output 13 Switch No. 208 to 223															
	MSB															LSB
	No.	15	14	13	12	11	10	9	8	7	6	5	4	3	2	1
	223	222	221	220	219	217	218	216	215	214	213	212	211	210	209	208
\$s94	Universal serial switch output 14 Switch No. 224 to 239															
	MSB															LSB
	No.	15	14	13	12	11	10	9	8	7	6	5	4	3	2	1
	239	238	237	236	235	234	233	232	231	230	229	228	227	226	225	224
\$s95	Universal serial switch output 15 Switch No. 240 to 255															
	MSB															LSB
	No.	15	14	13	12	11	10	9	8	7	6	5	4	3	2	1
	255	254	253	252	251	250	249	248	247	246	245	244	243	242	241	240
:																

Switch ON Macro Action

The macro command that controls a repeat function in the switch ON macro, as well as the processing sequence, is shown in the following diagram.

Switch action flowchart

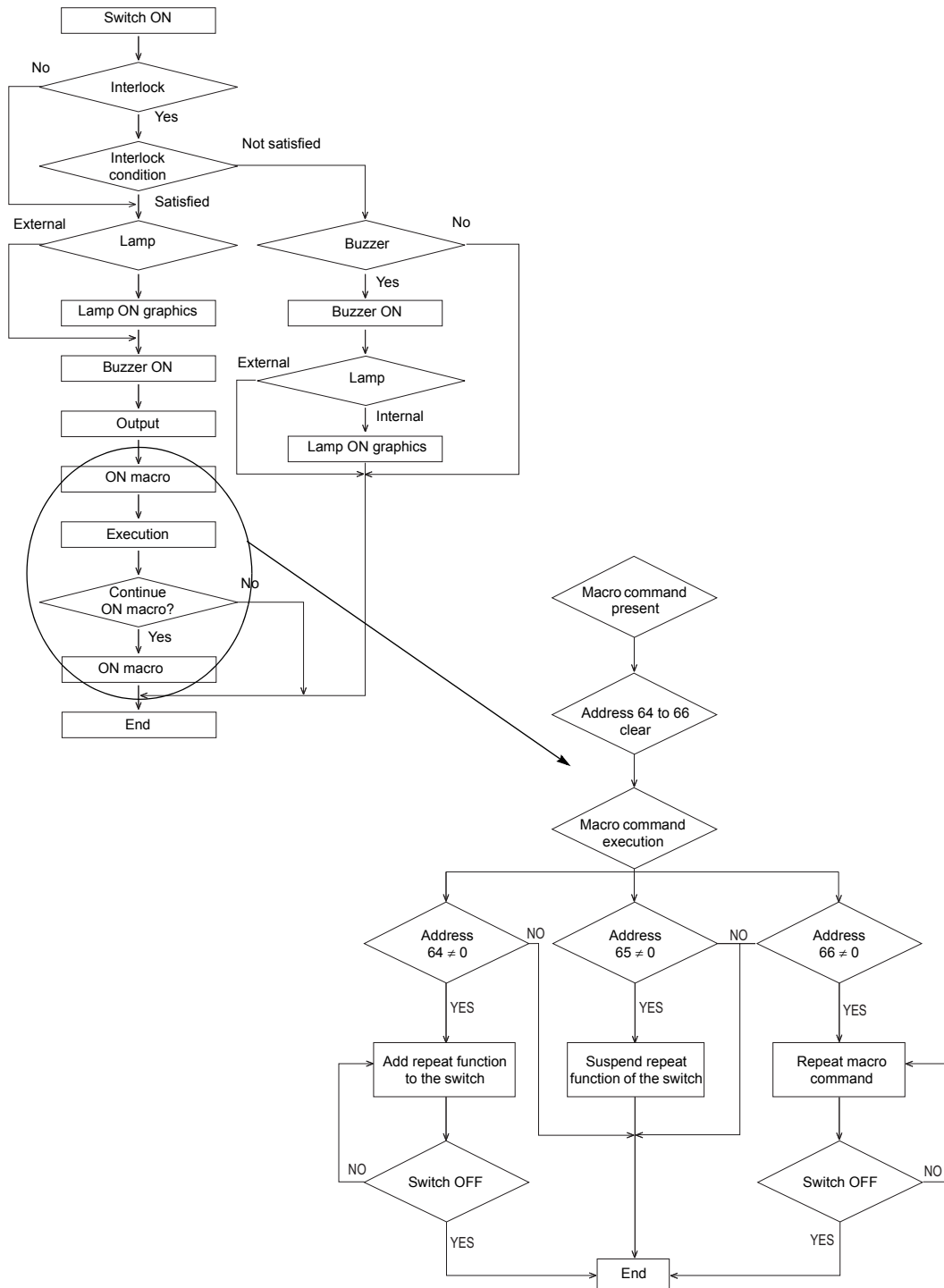

Appendix

- Appendix 1 Device Memory Map
- Appendix 2 Ethernet
- Appendix 3 System Memory
- Appendix 4 n : 1 Connection
- Appendix 5 Ladder Transfer Function

- Functions that use device memory maps
 - Periodical reading
The memory data registered in a device memory map is periodically transferred to other devices. (page App1-7)
 - Periodical writing
The data of other devices is periodically transferred to the memories registered in a device memory map. (page App1-9)
 - Synchronized reading
The data of each memory registered in a device memory map is transferred to another device when its bit is set (ON). (page App1-8)
 - Synchronized writing
The data of other devices is transferred to memory addresses that are registered in the memory map and whose bits are set (ON). (page App1-10)
 - Macro (TBL_READ, TBL_WRITE)
The data of memory addresses registered in a device memory map is transferred by using a macro command. (page App1-14)

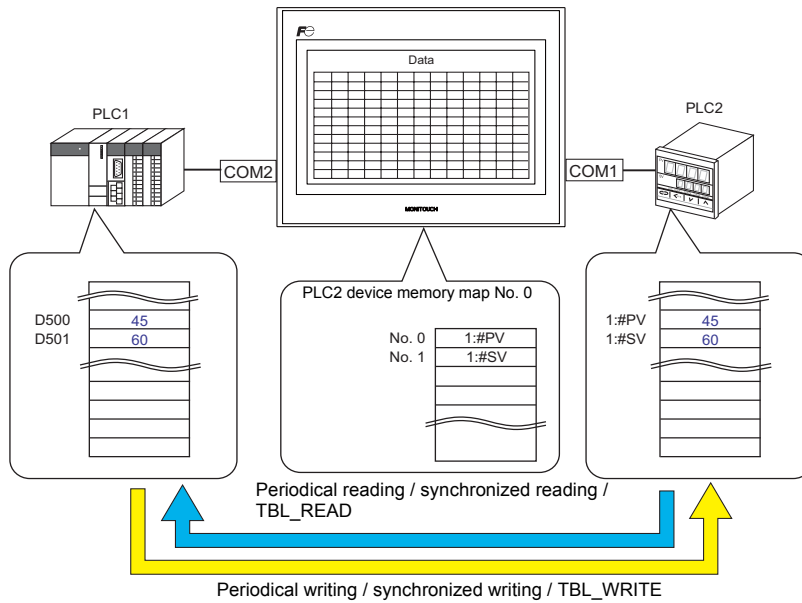

- Sampling
History data at the memory addresses registered in a device memory map is saved to the TS series internal buffer or storage such as a USB memory. (page App1-12)

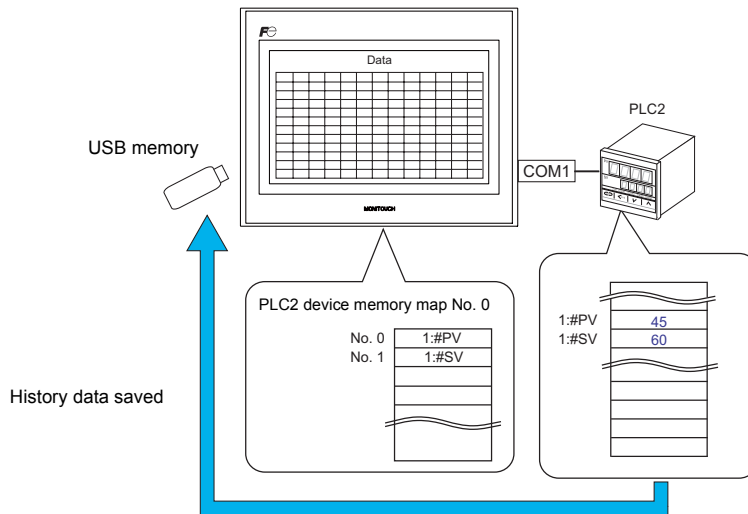

Device Memory Map Editing

Starting

1. Click [System Setting] → [Device Memory Map] → [PLCn].
The [Device Memory Map: PLCn] dialog is displayed.

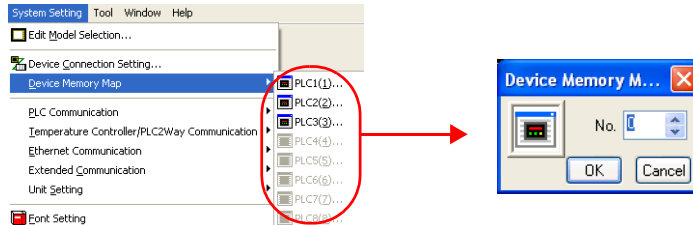

2. Select the device memory map number from 0 to 31 and click [OK].
The [Device Memory Map Edit] window is opened.

No.	PLC2 Memory	Name	Data Type	>> Target Memory 1	>> Target Memory 2
0					
1					
2					
3					
4					
5					
6					
7					
8					
9					
10					
11					
12					
13					

There are a total of 32 device memory maps numbered from 0 to 31 for each logical port, and 128 memory points can be registered for each memory map.

Ending

Click [Close] in the drop-down menu, or click the [Close] button at the top right corner.

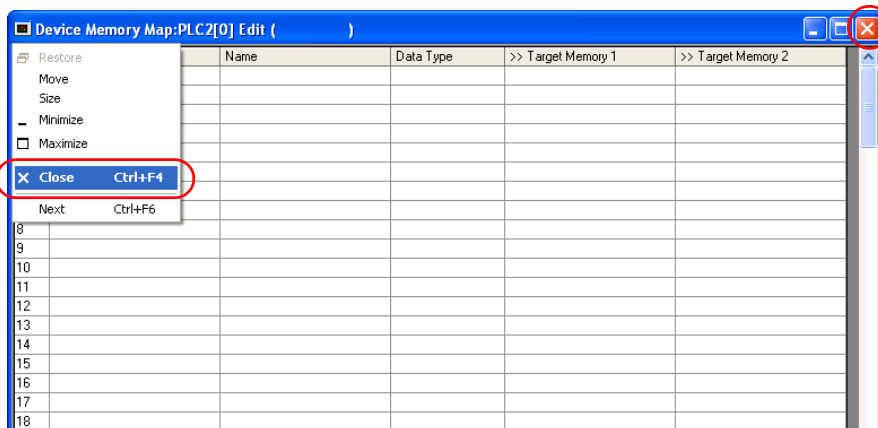

Comment Setting

A comment can be set for each device memory map.

1. Click [Edit] → [Comment]. The [Comment Setting] dialog is displayed.

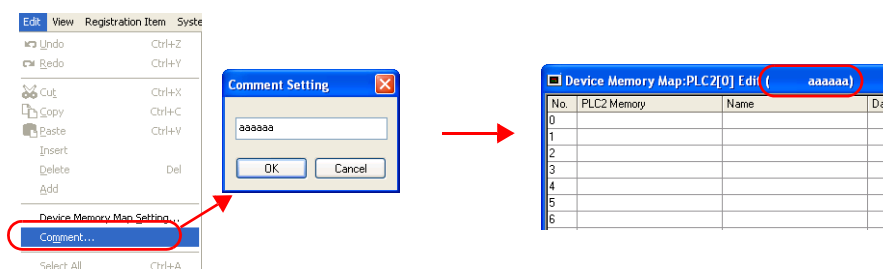

2. Enter the desired comment and click [OK]. The entered comment is displayed.

Device Memory Map Editing

Clicking any cell displays the relevant setting menu.

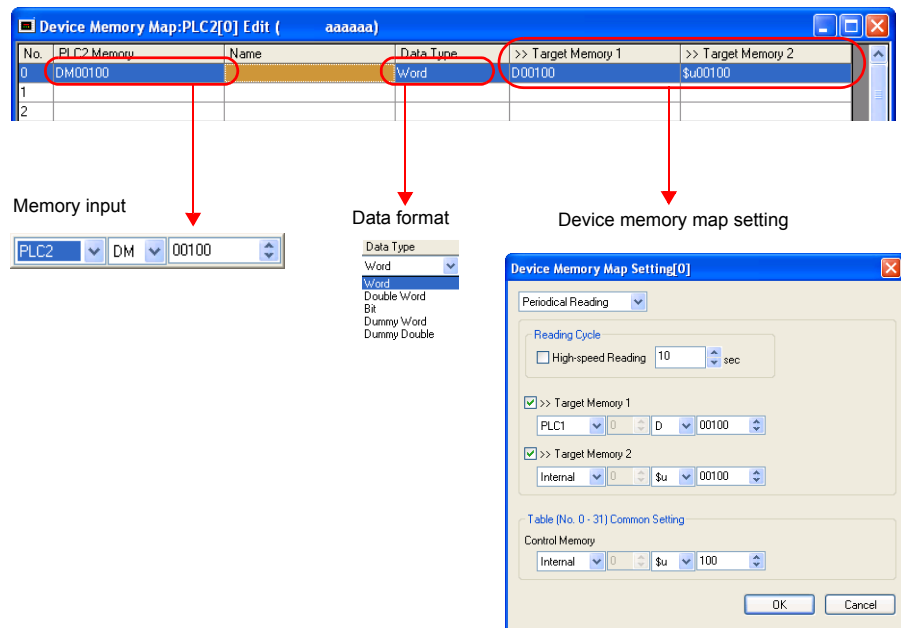

1. Memory Input

Specify the memory address whose data is to be transferred. If you have opened the PLC2 device memory map editing dialog, register the PLC2 memory.

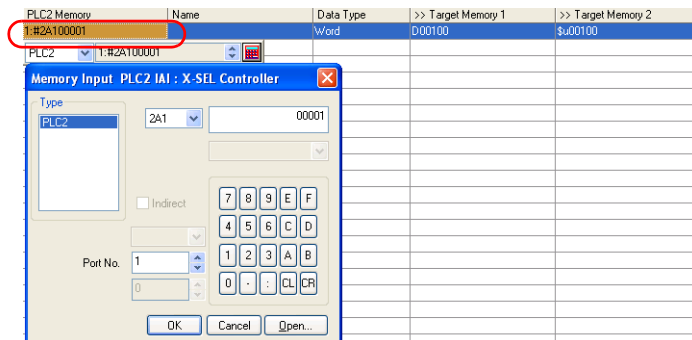

2. Data Type

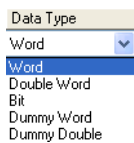

Word	Data is handled as numerical data of one word. Data is transferred based on the setting at [Code] in the [Communication Setting] tab window for each logical port. ^{*1}
Double Word	Data is handled as numerical data of two words. Data is transferred based on the setting at [Code] in the [Communication Setting] tab window for each logical port. ^{*1}
Bit	Data is handled as bit information of one word. Data is transferred <u>without conversion</u> . ^{*2}
Dummy Word Dummy Double	The source and target memory addresses are automatically registered with serial numbers assigned. If you would like to skip any memory address, keep the cell blank (no setting). It is regarded as a dummy word or double-word. For reading: "0" is always stored in the target memory address. The memory is not usable for any other purposes. For writing: The source memory address can be used for other purposes.

*1 When [Word] or [Double Word] is selected:
In the internal memory of the TS series, data is normally handled as DEC with signs.

	Code	Bit
Read ↓	Transfer source PLCn	Communication setting BCD
	TS internal memory	DEC
	Transfer target PLCm	Communication setting DEC
		Communication setting BCD

MSB		Bit																LSB	
15	14	13	12	11	10	9	8	7	6	5	4	3	2	1	0				
0	0	0	0	0	0	0	0	0	0	0	1	0	0	0	0				

MSB		Bit																LSB	
15	14	13	12	11	10	9	8	7	6	5	4	3	2	1	0				
0	0	0	0	0	0	0	0	0	0	0	0	1	0	1	0				

MSB		Bit																LSB	
15	14	13	12	11	10	9	8	7	6	5	4	3	2	1	0				
0	0	0	0	0	0	0	0	0	0	0	1	0	0	0	0				

*2 When [Bit] is selected:

	Code	Bit
Read ↓	Transfer source PLCn	Communication setting BCD
	TS internal memory	DEC
	Transfer target PLCm	Communication setting DEC BCD

MSB		Bit																LSB	
15	14	13	12	11	10	9	8	7	6	5	4	3	2	1	0				
0	0	0	0	0	0	0	0	0	0	0	1	0	0	0	0				

3. Device memory map setting

In this dialog, set the use of each memory map.

- TBL_READ, TBL_WRITE
- Periodical Reading → page App1-7
- Synchronized Reading → page App1-8
- Periodical Writing → page App1-9
- Synchronized Writing → page App1-10

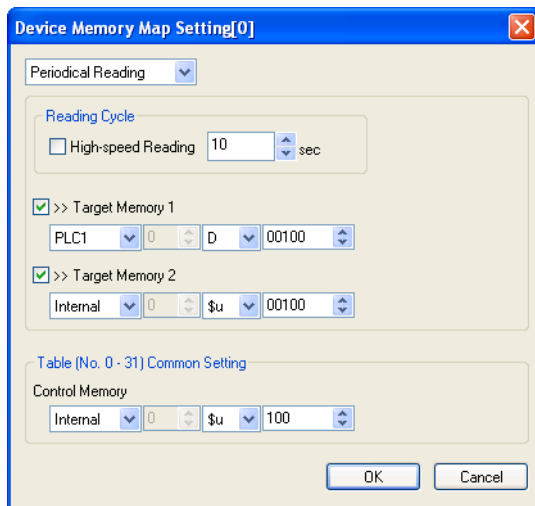

Enabling interruption

Interrupt is enabled by selecting [Enabling Interruption] in the right-click menu displayed by right-clicking on the device memory map number. The "*" mark is displayed at the selected memory.

When interruption is enabled, switch data output, cycle reading or sampling can be executed during the device memory map process.

Operation in the setting shown below:

Reading group 0 (No. 0 to No. 7)

↓

Switch data output, cycle reading or sampling

↓

Reading group 1 (No. 8 to No. 15)

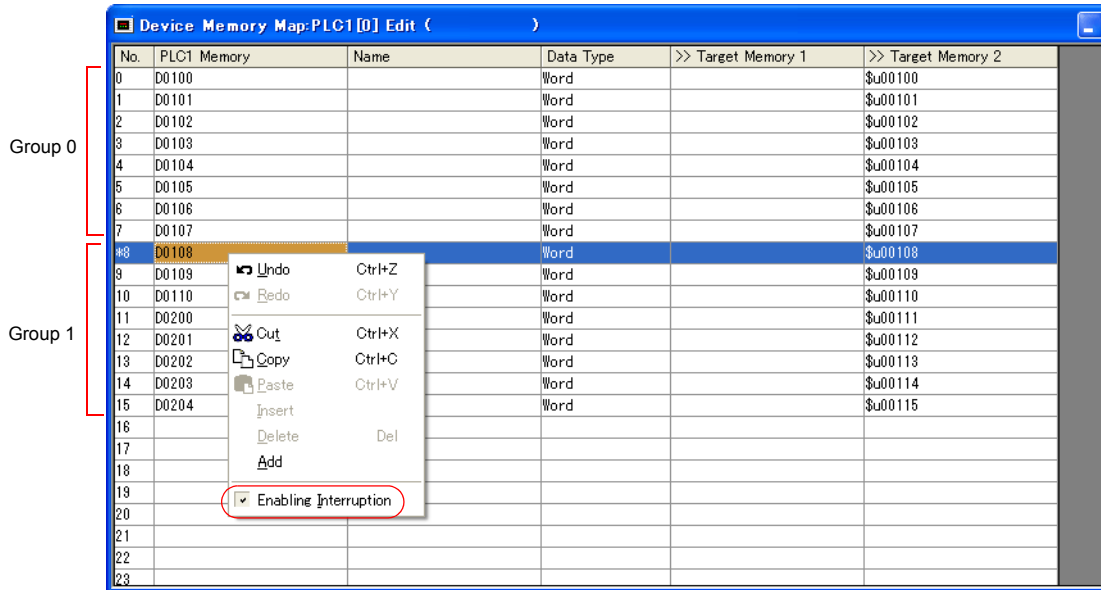

Periodical Reading

The memory data registered in a device memory map is transferred to the target memory address every cycle set at [Reading Cycle].

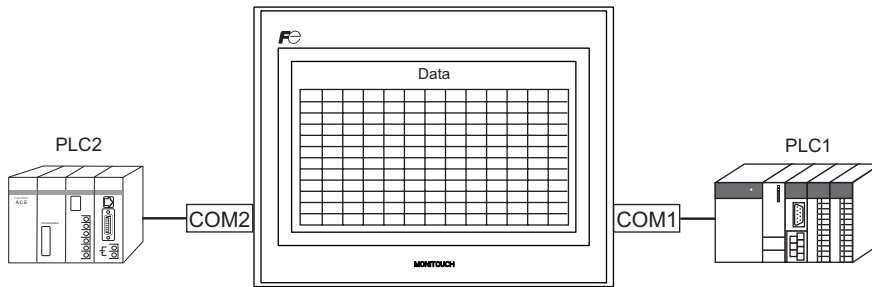

PLC2 device memory map No. 0

No.	PLC2 Memory	Name	Data Type	>> Target Memory 1	>> Target Memory 2
0	1:#2A100001		Word	D00100	\$u00100
1	0:#20B01600		Word	D00101	\$u00101
2					
3					
4					
5					
6					
7					

Transferred at intervals of 5 sec.

Setting items

Items that must be set to perform periodical reading

- "Device Memory Map Editing" (page App1-3)
- Device memory map setting

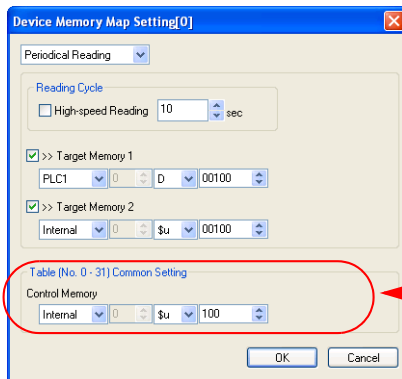

Disabled when [Periodical Reading] is selected.

Function	Periodical Reading											
Reading Cycle	Specify the data read cycle. <table border="1" style="margin-left: 20px;"> <thead> <tr> <th rowspan="2">[High-speed Reading] check box</th> <th colspan="2">Reading Cycle</th> </tr> <tr> <th>Setting Range</th> <th>Unit</th> </tr> </thead> <tbody> <tr> <td>Unchecked</td> <td>1 to 3600</td> <td>1s</td> </tr> <tr> <td>Checked</td> <td>1 to 3600</td> <td>100 ms</td> </tr> </tbody> </table>	[High-speed Reading] check box	Reading Cycle		Setting Range	Unit	Unchecked	1 to 3600	1s	Checked	1 to 3600	100 ms
[High-speed Reading] check box	Reading Cycle											
	Setting Range	Unit										
Unchecked	1 to 3600	1s										
Checked	1 to 3600	100 ms										
>> Target Memory 1 >> Target Memory 2	Set the memory address at which the read data is to be stored.											
Control Memory	This option is disabled when [Periodical Reading] is selected.											

Synchronized Reading

The memory data registered in a device memory map is transferred to the target memory address at the leading edge of each bit (0 → 1).

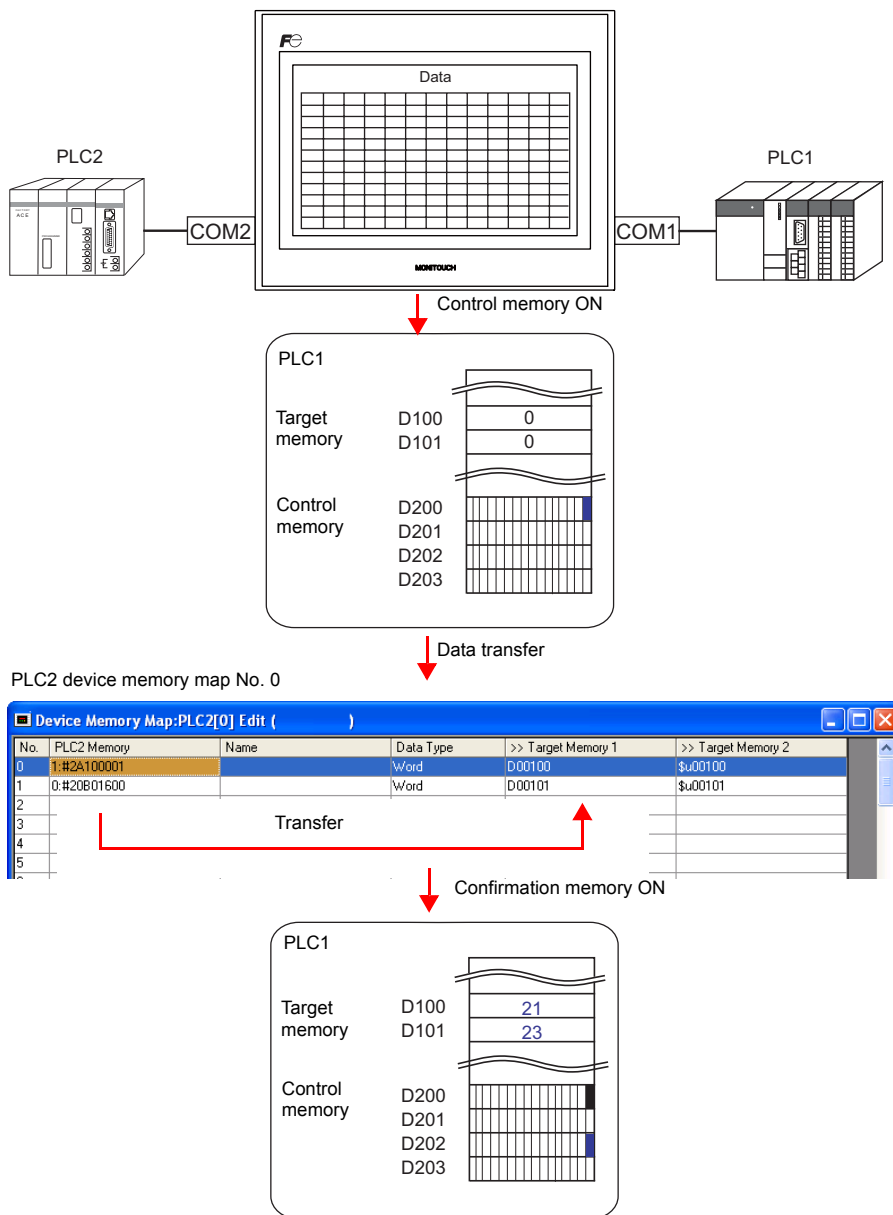

Setting items

Items that must be set to perform synchronized reading

- "Device Memory Map Editing" (page App1-3)
- Device memory map setting

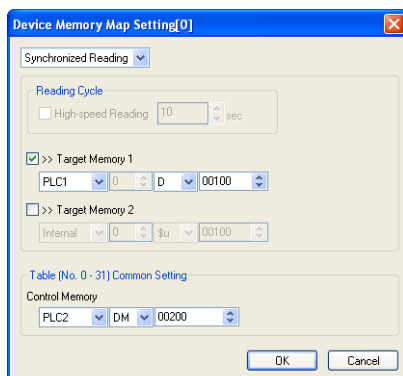

Function	Synchronized Reading
>> Target Memory 1 >> Target Memory 2	Set the memory address at which the read data is to be stored.
Control Memory	Enter a memory address as the trigger for synchronized reading. The specified memory address is used for the device memory map Nos. 0 to 31. Four words are occupied. For more information, see "Control Memory" (page App1-11).

Periodical Writing

The data at the source memory address is transferred to a memory registered in a device memory map in each cycle set at [Writing Cycle].

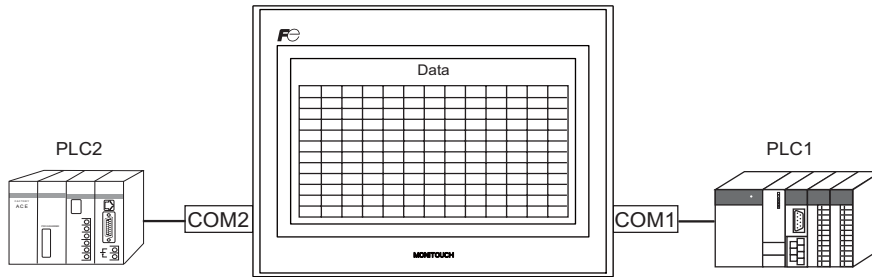

PLC2 device memory map No. 0

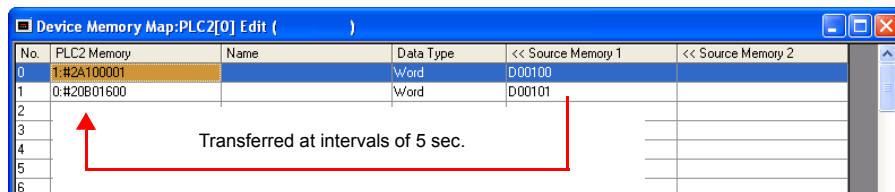

Setting items

Items that must be set to perform periodical writing

- "Device Memory Map Editing" (page App1-3)
- Device memory map setting

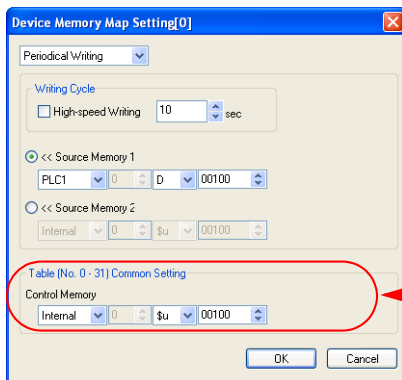

Disabled when [Periodical Writing] is selected.

Function	Periodical Writing									
Writing Cycle	Specify the data writing cycle. <table border="1" style="margin-left: 20px;"> <tr> <td rowspan="3" style="text-align: center;"><input type="checkbox"/> [High-speed Writing] check box</td> <td colspan="2" style="text-align: center;">Writing Cycle</td> </tr> <tr> <td style="text-align: center;">Setting Range</td> <td style="text-align: center;">Unit</td> </tr> <tr> <td style="text-align: center;">Unchecked</td> <td style="text-align: center;">1 to 3600 1 s</td> </tr> <tr> <td style="text-align: center;">Checked</td> <td style="text-align: center;">1 to 3600 100 ms</td> </tr> </table>	<input type="checkbox"/> [High-speed Writing] check box	Writing Cycle		Setting Range	Unit	Unchecked	1 to 3600 1 s	Checked	1 to 3600 100 ms
<input type="checkbox"/> [High-speed Writing] check box	Writing Cycle									
	Setting Range		Unit							
	Unchecked	1 to 3600 1 s								
Checked	1 to 3600 100 ms									
<< Source Memory 1 << Source Memory 2	Specify the memory address of the source data.									
Control Memory	This option is disabled when [Periodical Writing] is selected.									

Synchronized Writing

The data at the source memory address is transferred to a memory address registered in a device memory map at the leading edge of the control memory bit (0 → 1).

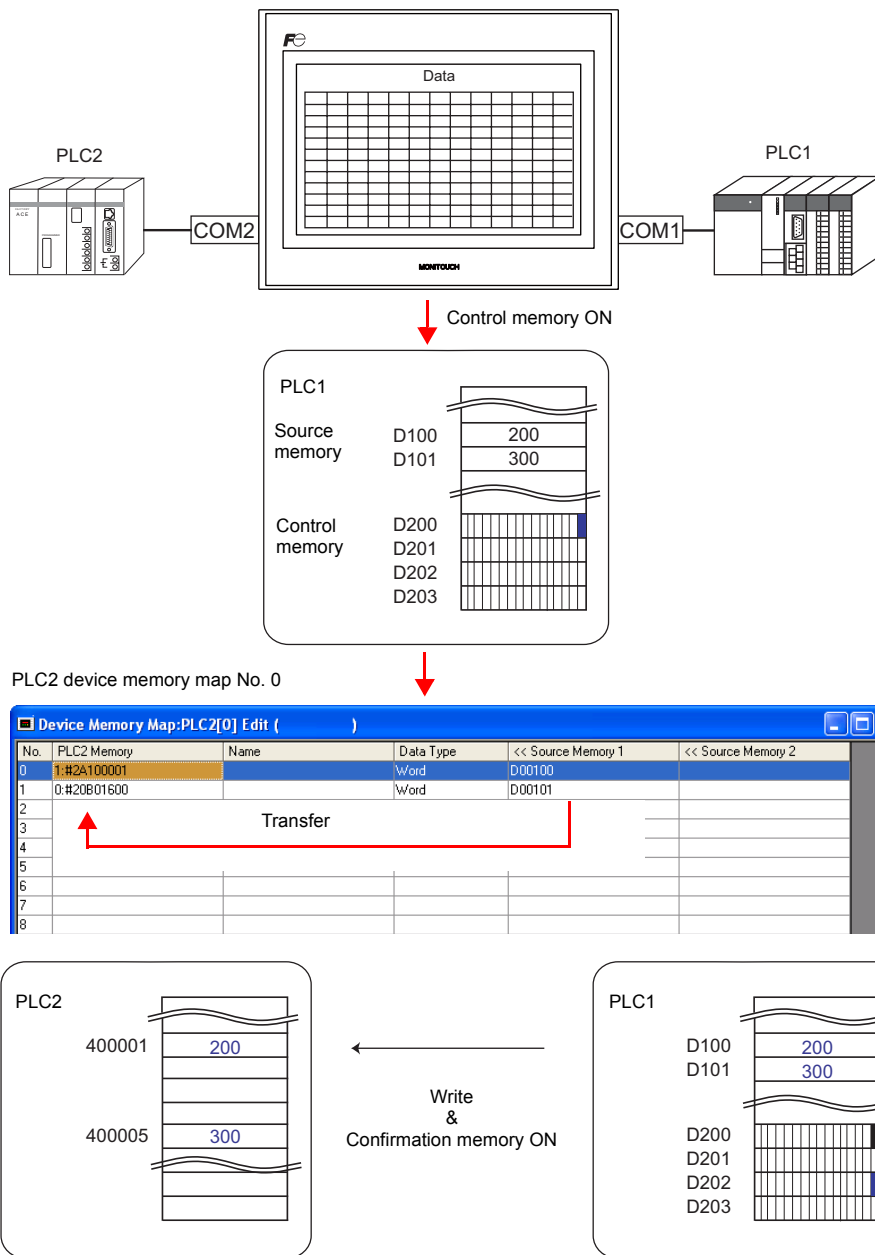

Setting items

Items that must be set to perform synchronized writing

- "Device Memory Map Editing" (page App1-3)
- Device memory map setting

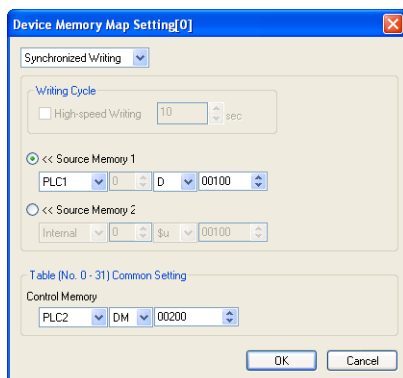

Function	Synchronized Writing
<< Source Memory 1 << Source Memory 2	Specify the storage target memory address for the source data.
Control Memory	Enter a memory address as the trigger for synchronized reading. The specified memory address is used for the device memory map Nos. 0 to 31. Four words are occupied. For more information, see "Control Memory" (page App1-11).

Control Memory

Control memory is used for executing synchronized reading/synchronized writing.
Consecutive four words starting from control memory "n" are allocated.

Control Memory n	Contents	Memory Type
n	Read/Write command memory	→ V
n + 1		
n + 2	Read/Write confirmation memory	← V
n + 3		

Read/Write command memory (control memory "n" and "n + 1")

One bit is allocated to each device memory map.

At the leading edge of a bit (0 → 1), reading from or writing to memory set in the corresponding device memory map occurs.

n

15	14	13	12	11	10	9	8	7	6	5	4	3	2	1	0	← Bit number
15	14	13	12	11	10	9	8	7	6	5	4	3	2	1	0	←

Device memory map Nos. 0 to 15

n + 1

15	14	13	12	11	10	9	8	7	6	5	4	3	2	1	0	← Bit number
31	30	29	28	27	26	25	24	23	22	21	20	19	18	17	16	←

Device memory map Nos. 16 to 31

Read/Write confirmation memory (control memory "n + 2" and "n + 3")

One bit is allocated to each device memory map.

When the bit of the command memory is set (0 → 1) and the resulting reading or writing is completed, the bit of the corresponding confirmation memory is set (0 → 1).

When a bit of the command memory is reset (1 → 0), the confirmation memory bit of the corresponding memory map number is reset (1 → 0).

n + 2

15	14	13	12	11	10	9	8	7	6	5	4	3	2	1	0	← Bit number
15	14	13	12	11	10	9	8	7	6	5	4	3	2	1	0	←

Device memory map Nos. 0 to 15

n + 3

15	14	13	12	11	10	9	8	7	6	5	4	3	2	1	0	← Bit number
31	30	29	28	27	26	25	24	23	22	21	20	19	18	17	16	←

Device memory map Nos. 16 to 31

* For synchronized reading

When reading for any addresses registered in the device memory map has been finished successfully, the confirmation memory is set.

If not, the confirmation memory will not be set.

* For synchronized writing

The confirmation memory is set on completion of writing regardless of whether or not writing has been done successfully.

Sampling

History data at the memory addresses registered in a device memory map is saved to the TS series internal buffer or storage such as a USB memory.

Setting items

Items that must be set to perform sampling

- “Device Memory Map Editing” (page App1-3)
- Device memory map setting
- Buffering area setting
- Trend sampling or data sampling

Device memory map setting

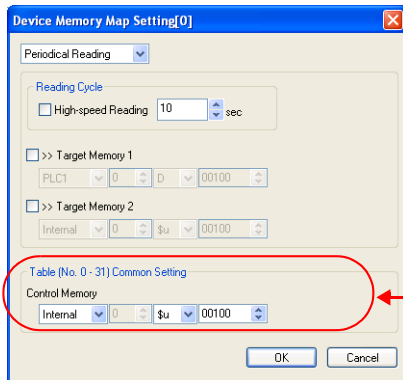

Disabled when [Periodical Reading] is selected.

Function	Periodical Reading											
Reading Cycle	Specify the data read cycle.											
	<table border="1"> <tr> <td rowspan="2"><input type="checkbox"/> [High-speed Reading] check box</td> <td colspan="2">Reading Cycle</td> </tr> <tr> <td>Setting Range</td> <td>Unit</td> </tr> <tr> <td>Unchecked</td> <td>1 to 3600</td> <td>1 s</td> </tr> <tr> <td>Checked</td> <td>1 to 3600</td> <td>100 ms</td> </tr> </table>	<input type="checkbox"/> [High-speed Reading] check box	Reading Cycle		Setting Range	Unit	Unchecked	1 to 3600	1 s	Checked	1 to 3600	100 ms
	<input type="checkbox"/> [High-speed Reading] check box		Reading Cycle									
Setting Range		Unit										
Unchecked	1 to 3600	1 s										
Checked	1 to 3600	100 ms										
>> Target Memory 1 >> Target Memory 2	When unchecked: Since sampling data is stored to the TS internal buffer or storage such as a USB memory, these items do not need to be set.											
Control Memory	This option is disabled when [Periodical Reading] is selected.											

Buffering area setting

Click [System Setting] → [Buffering Area Setting]. The [Buffering Area Setting] dialog is opened.

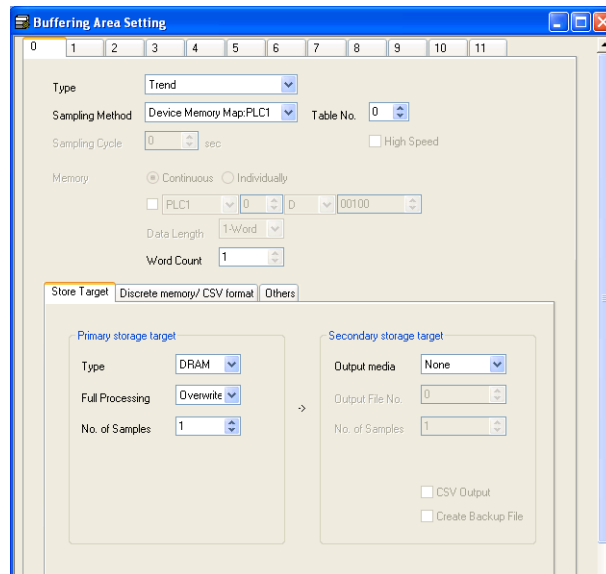

Type	Trend
Sampling Method	Device Memory Map: PLCn
Table No.	Select the device memory map number for sampling.
Word Count	The number of words is automatically set in this area based on the data in the device memory map.
Store Target	Set the desired storage target for storing sampling data.
Discrete memory / CSV format	The memory addresses of the device memory map set at [Table No.] are displayed here.

* For more information on the buffering area setting, refer to the V8 Series Reference Manual.

Trend sampling/data sampling part

To display the sampling data on the screen, place a trend sampling part or a data sampling part. Click the [Trend Sampling] or [Data Sampling] icon and make the setting.

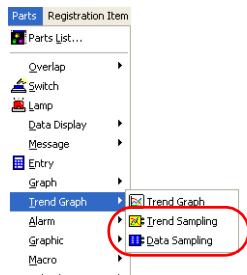

* The numbers in the [Discrete memory/ CSV format] menu of the [Buffering Area Setting] dialog are automatically set according to the data in the [Device Memory Map]. Therefore, specify the same number as that in the [Discrete memory/ CSV format] menu for the [Sampling Buffer Word No.].

For more other information, refer to the V8 Series Reference Manual provided separately.

TBL_READ / TBL_WRITE

The data at the memory addresses registered in a device memory map is batch transferred using the [TBL_READ] and [TBL_WRITE] macro commands.

Setting items

Items that must be set to perform memory data transfer set in the device memory map

- “Device Memory Map Editing” (page App1-3)
- Device memory map setting
- Macro (TBL_READ / TBL_WRITE)
- Memory card setting (when a memory card is used)

Device memory map setting

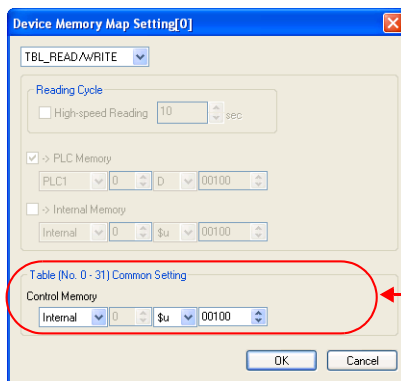

Disabled when [TBL_READ/TBL_WRITE] is selected.

Function	TBL_READ/TBL_WRITE * Even device memory maps for which other functions have been selected can be transferred using these macros.
Control Memory	This option is disabled when [TBL_READ/TBL_WRITE] is selected.

Macro

Register the following macros for switch ON macro or interval timer. For more information on macros, refer to the Macro Reference manual.

- TBL_READ
Data at a memory address registered in a device memory map is transferred to a memory address in another device.
- TBL_WRITE
Data at another device is transferred to a memory address registered in a device memory map.

Memory card setting

These settings are made when the target memory or source memory is a memory card memory.

1. Click [System Setting] → [Memory Card Setting]. The [Memory Card Setting] dialog is opened.
2. Select [Data File] for [Type].
Be sure to check [Use Device Memory Map].
3. Set [No. of Records].
By clicking [Table No.] and setting the device memory map number, the necessary number of records can be set automatically.

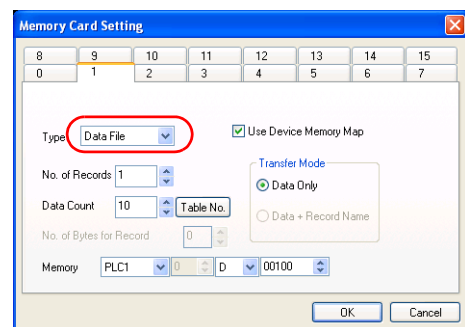

Appendix 2 Ethernet

Overview

The following Ethernet functions are available with the TS series.

When using Ethernet communications, you need to set the IP address of the TS unit. The other settings differ according to the functions to be used.

Function	PLC Communication						Macro EReAD EWRITE SEND MES	HKEtn20 .dll	Screen Data Transfer	Web Server E-Mail FTP Server	Network Camera Remote Desktop
	Communication Protocol		Baud Rate *1		Communication Mode *1						
	TCP/IP	UDP/IP	100M bps	10M bps	Full Duplex	Half Duplex					
TS series											
TS1100i TS1070i	<input type="radio"/>	<input type="radio"/>	<input type="radio"/>	<input type="radio"/>	<input type="radio"/>	<input type="radio"/>	<input type="radio"/>	<input type="radio"/>	<input type="radio"/>	<input type="radio"/>	<input type="radio"/> *2
	↓ App2-2						↓ App2-4	↓ App2-5	↓ App2-6	↓ App2-6	

*1 Automatically adjusted to connected devices

*2 128-color mode not supported

PLC Communication

Ethernet communications are possible with PLCs.

- 1 : 1 connection

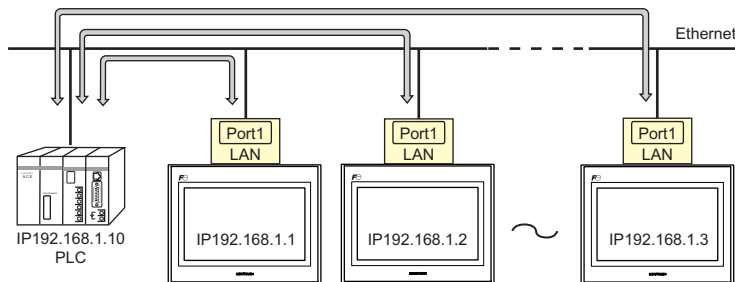

- 1 : n connection
TS series can communicate with multiple PLCs on Ethernet.

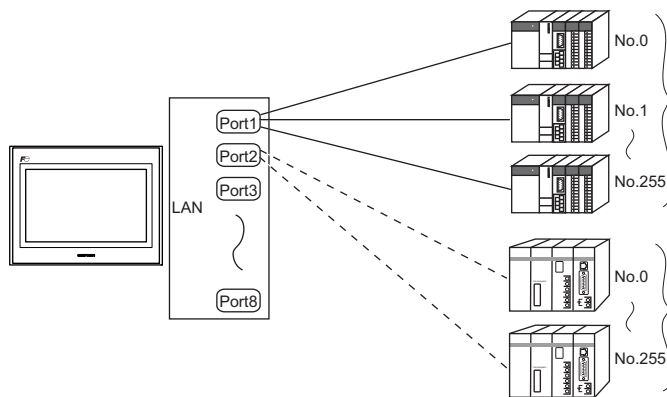

Setting items

The following settings are required to communicate with PLCs via an Ethernet.

- IP address setting of the TS series
Make this setting in the [IP Address Setting] dialog of the V-SFT editor, or on the Main Menu screen of the TS series.
See page App2-7.
- Device connection setting
 - Selecting a device to be connected
 - Communication setting (connection mode, TS port number)
 - Target settings (connection target, PLC table)
 See page App2-3.
- Setting on PLC
Set the IP address, port number and others of PLC.
For more information, refer to the instruction manual for the PLC issued by the manufacturer.

Device Connection Setting

1. Select models compatible with Ethernet communications under [System Setting] → [Device Connection Setting].

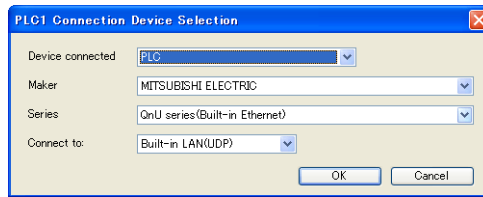

2. [System Setting] → [Device Connection Setting] → [Communication Setting]

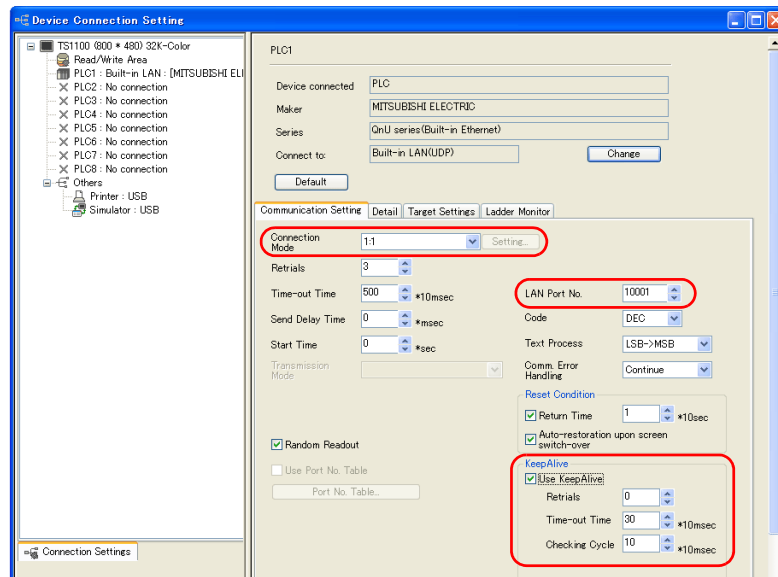

Connection Mode	1 : 1 / 1 : n Set the number of PLCs that are to be communicated with.
LAN Port No.	Set the port number of the TS series to be used for communications with the PLCs.
KeepAlive	<p>This setting is used when using the "KeepAlive" function. The "KeepAlive" function is used for periodically checking the connection with devices on the network. When using this function, select [Disconnect] for [Comm. Error Handling]. This function enables a prompt detection of a communication error, thus, significantly shortens the time to wait until a "disconnect" process takes place after an occurrence of the time-out error.</p> <p>* Internal memory must be specified for [Read Area] and [Write Area].</p> <ul style="list-style-type: none"> • <input type="checkbox"/> Use KeepAlive Check this box when using the "KeepAlive" function. The following settings will take effect when selected. <ul style="list-style-type: none"> - [Retrials] Specify the number of retries. If a timeout persists even after as many retries as specified, an error handling routine will take place. 0 to 255 Default: 0 - [Time-out Time] Specify a period of time for monitoring a response from the connected device. If no response is given within the specified time, retry will be made. 1 to 999 (×10 msec) Default: 30 (×10 msec) - [Checking Cycle] Set the cycle time of "KeepAlive" communication. 1 to 999 (×10 msec) Default: 10 (×10 msec)

* For settings other than the above, see "1.5.1 PLC1 to PLC8" on page 1-24.

3. [System Setting] → [Device Connection Setting] → [Target Settings]

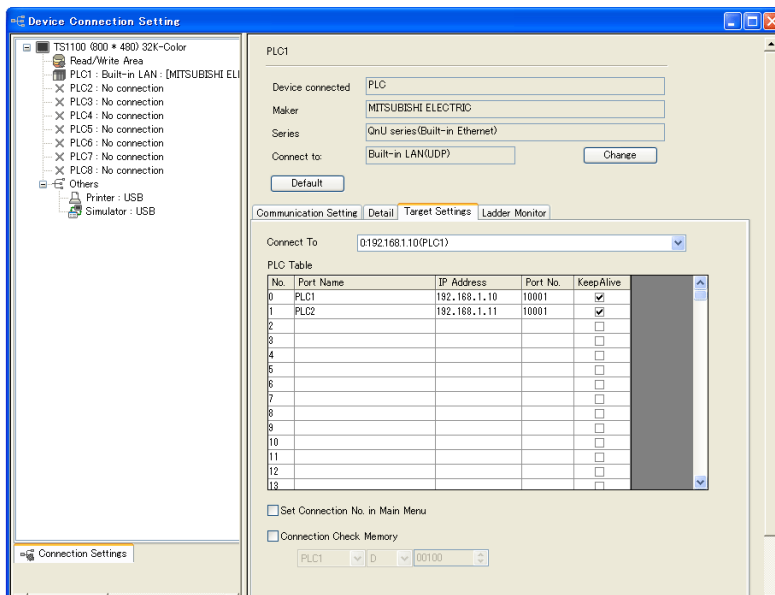

Target Settings	These settings are valid when [1 : 1] is selected for [Connection Mode]. Select the IP address of the PLC registered in the PLC table. 1 : 1 communications are executed with the PLC selected here.
PLC Table No. 0 to 99	Set the IP address, port number and others of PLC.
KeepAlive	Check the box for the PLC for which communication status is to be checked by using the "KeepAlive" function.

Macro EREAD/EWRITE

Data can be transferred among TS units in an Ethernet network using macro commands (ERead/EWRITE). As the data for transfer, data in the TS internal memory or data in the memories of PLCs that communicate with the TS series can be specified.

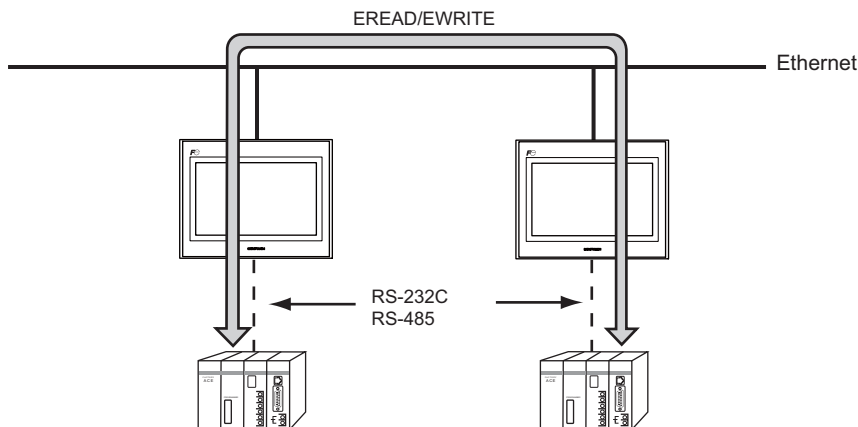

Setting Items

The following settings are necessary when transferring data using macro commands.

- IP address setting of the TS series
Make this setting in the [IP Address Setting] dialog of the V-SFT editor, or on the Main Menu screen of the TS series.
See page App2-7.
- Network table
Set the IP address and port No. of the TS series that is to be the send target for the macro command.
See page App2-10.
- Macro command
ERead/EWRITE
See page App2-12.

Connection with Computer

Communications between the computer and the TS

- "HKEtn20.dll" (for UDP/IP protocol) is provided so that the user can create an original application by using Visual C++ or Visual Basic, etc. to allow the computer to access the memory device, such as TS internal memory, memory card or the PLC memory connected with the TS..... (a)
- The macro command (SEND) enables the TS to access the computer..... (b)

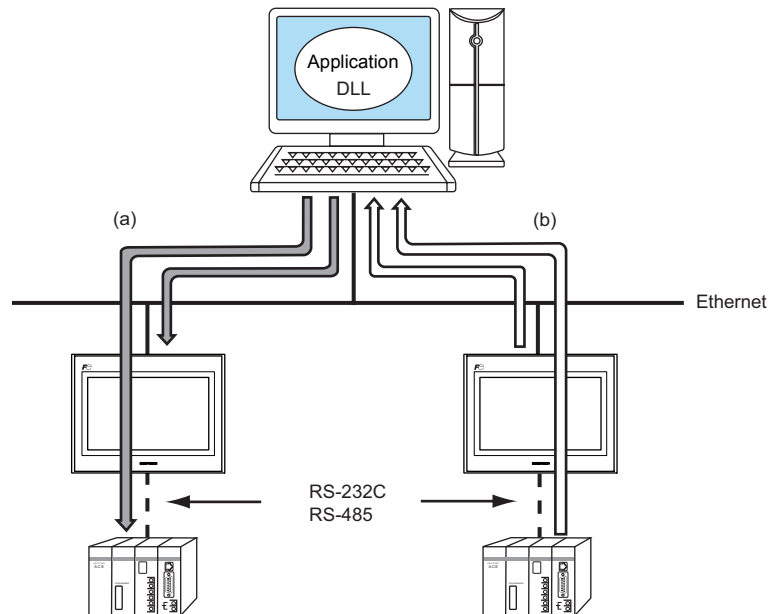

Setting Items

The following settings are required.

- IP address setting of the TS series
Make this setting in the [IP Address Setting] dialog of the V-SFT editor, or on the Main Menu screen of the TS series.
See page App2-7.
- Network table
Set the IP address and port No. of the computer that is to be the send target for the macro command.
This is not necessary if the SEND command is not used.
See page App2-10.
- Macro command
SEND
See page App2-12.
- Applications that use HKEtn20.dll
For details on HKEtn20.dll, refer to the separate V series DLL Function Specifications manual.

Screen Data Transfer

Screen data can be sent from the computer to the TS series using the editor.

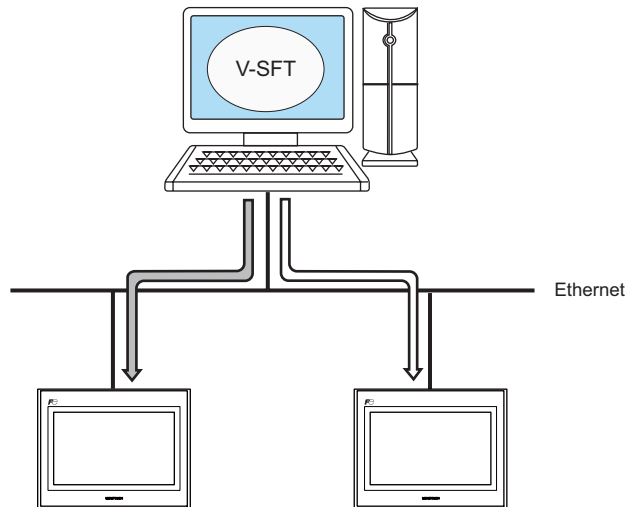

Setting Items

The following settings are required to transfer screen data via an Ethernet connection.

- IP address setting of the TS series
Make this setting in the [IP Address Setting] dialog of the V-SFT editor, or on the Main Menu screen of the TS series.
See page App2-7.

For details on the transfer procedure, refer to the Operation Manual.

E-Mail

The e-mail send function can be used at the built-in LAN port.
For details on the e-mail send function, refer to the Reference Manual.

Web Server

The web server function can be used at the built-in LAN port.
For details on the web server function, refer to the Reference Manual.

IP Address Setting of the TS Series

To use the Ethernet functions, it is necessary to set the IP addresses. Set the IP address either on the TS unit or for screen data using the V-SFT editor.

- * If the IP is set in both of these ways, the IP address set by using the V-SFT editor is taken as the valid one.

1: Setting using the V-SFT Editor

Set the IP address using the V-SFT editor.

1. Select [System Setting] → [Ethernet Communication] → [Local Port IP Address]. The [IP Address Setting] dialog is displayed.
2. Check the Set IP] check box and set each item.

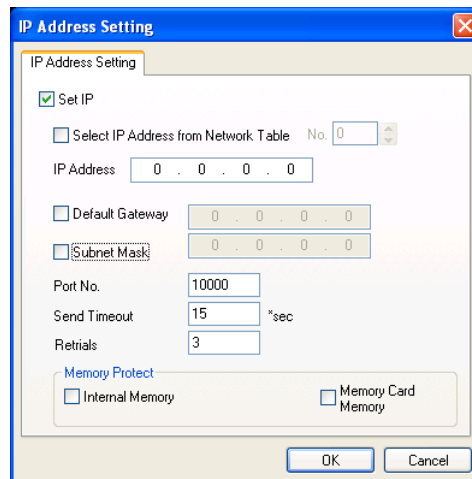

<input type="checkbox"/> Select IP Address from Network Table	This is valid when the IP address of the TS has been registered in the network table. Select a network table number from 0 to 99 to set the IP address.
IP address *1	Set the IP address for the TS.
<input type="checkbox"/> Default Gateway *1	Set the default gateway.
<input type="checkbox"/> Subnet Mask *1	Set the subnet mask. When this box is not checked, the subnet mask is automatically assigned based on the byte at the extreme left of the IP address. Example: When IP address is "172.16.200.185", "255.255.0.0" is set. When IP address is "192.168.1.185", "255.255.255.0" is set.
<input type="checkbox"/> Port No. *1	Set a port number from 1024 to 65535. Other than 8001.
Send Timeout	Specify the timeout time to send the EREAD/EWRITE command.
Retrials	0 to 255 Set the number of retrials to be performed when a time-out occurs.
Memory Protect <input type="checkbox"/> Internal Memory <input type="checkbox"/> Memory Card Memory	Check either check box to write-protect the memory from computers or other stations.

*1 For more information on each setting item, see page App2-9.

3. Click [OK].
4. Transfer the screen data to the TS series.

2: Setting on the Main Menu Screen of the TS Series

Set the IP address on the Main Menu screen of the TS series.

If IP address setting has been performed on the V-SFT editor, this setting will be taken as the valid one.

1. Hold down any one of the four corners of the screen for 2 seconds or longer and remove your finger. Then within 1 second, hold down one of the other three corners for 2 seconds or longer. The System Menu is displayed.
2. While the System Menu is displayed, press the [MODE] switch. The screen switches to the Main Menu screen.
3. Pressing the [Main Menu] switch at the top left corner brings up the drop-down window.
4. Press the [Ethernet] switch to display the Ethernet screen.

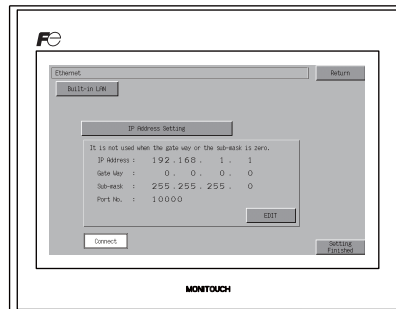

5. Press the [EDIT] switch and set each item.

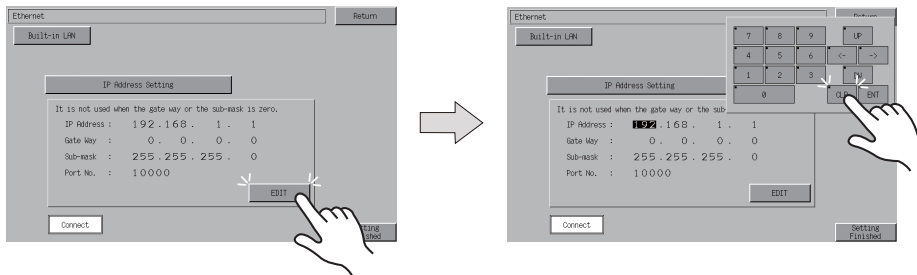

6. Press the [Setting Finished] switch to end setting. Check the IP address displayed at "Ethernet Information" on the Main Menu screen.

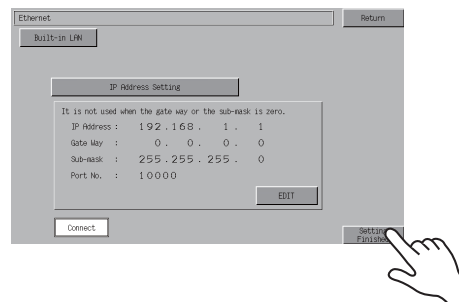

IP Address

This is an address that is used for recognizing each node on the Ethernet and should be unique. The IP address is 32-bit data which consists of the network address and the host address and can be classified into A to C depending on the network size.

Class A	0	Network address (7)	Host address (24)
Class B	10	Network address (14)	Host address (16)
Class C	110	Network address (14)	Host address (8)

<Notation>

A string of 32-bit data is divided into four, and each segment delimited with a period is in decimal notation.

Example: The IP address in class C shown below is represented as "192.128.1.50".

11000000 10000000 00000001 00110010

<Unusable IP addresses>

- "0" is specified for one byte at the extreme left. Example: 0.x.x.x
- "127" is specified for one byte at the extreme left (loop back address). Example: 127.x.x.x
- "224" or more is specified for one byte at the extreme left (for multi-cast or experiment). Example: 224.x.x.x
- The host address consists of only "0" or "255" (broadcast address). Example: 128.0.255.255, 192.168.1.0

Port No.

Multiple applications are running on each node, and communications are carried out for each application between the nodes. Consequently, it is necessary to have a means to identify the application that data should be transferred to. The port number works as this identifier. Each port number is 16-bit data (from 0 to 65535).

The TS series uses the port for screen data transfer (8001), PLC communication (as desired), and the simulator (8020). Set a unique number in the range of 1024 to 65535. For a PLC or a computer, set the port number in the range of 256 to 65535. It is recommended to set a greater number.

Default Gateway

A gateway and a router are used for communication between different networks.

The IP address of the gateway (router) should be set to communicate with the node(s) on other network.

Subnet Mask

A subnet mask is used for dividing one network address into multiple networks (subnet).

The subnet is assigned by specifying a part of the host address in the IP address as a subnet address.

Class B	10	Network address (14)	Host address (16)
Subnet mask		255. 255. 255. 0	
		11111111 11111111 11111111 00000000	
		Network address Subnet address Host address	

<Unusable subnet masks>

- All bits are set to "0". → 0.0.0.0
- All bits are set to "1". → 255.255.255.255

Network Table

- When macro commands EREAD/EWRITE/SEND are used, network table settings have to be made. Register the IP address and port number of the send target TS series and computer in the network table of the TS series that is the macro command send source.
 - Example

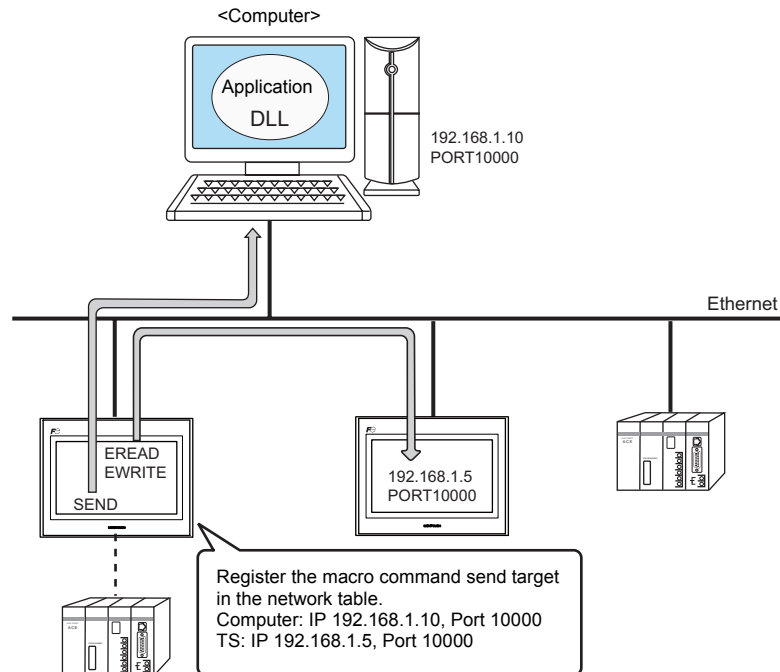

- The network table is transferred to the TS series together with screen data.

Starting and Ending

Starting

Select [System Setting] → [Ethernet Communication] → [Network Table]. The [Network Table Edit] window is displayed.

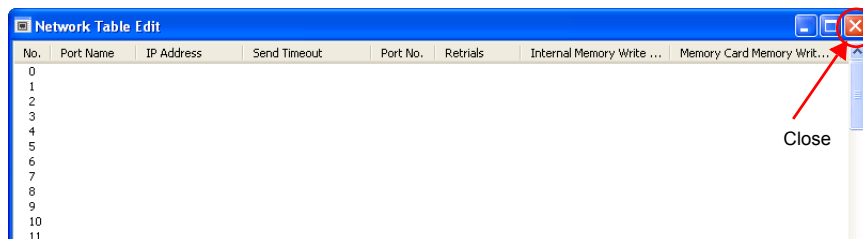

Ending

Click [File] → [Close], or click the [X] (close) button to end operation.

Network Table Setting

Double-clicking a number in the No. column displays a [Network Table Setting] dialog.

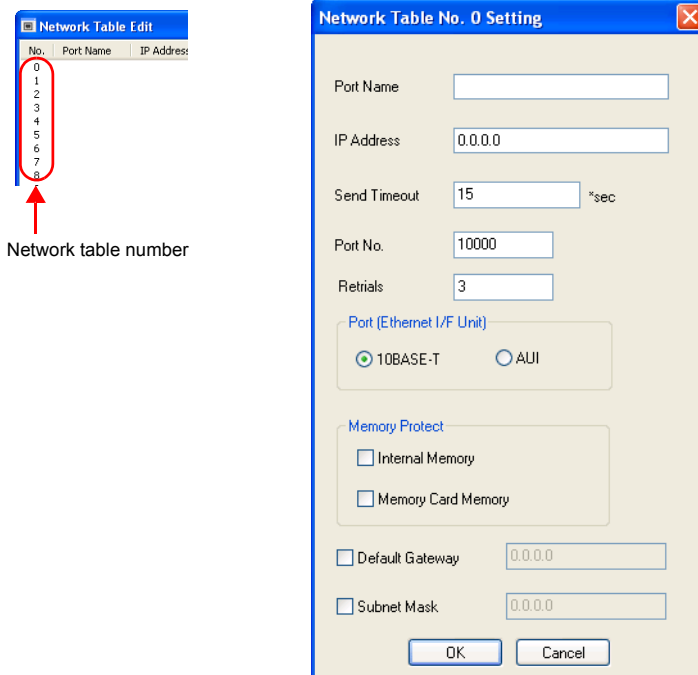

Port Name	Set the name of the TS or the computer.
IP Address ^{*2}	Set the IP address of the TS or the computer.
Send Timeout ^{*1}	Specify the timeout time to send the EREAD/EWRITE command.
Port No. ^{*2}	Set the port number of the TS or the computer.
Retrials ^{*1}	0 to 255 Set the number of retrials to be performed when a time-out occurs.
Port ^{*1}	10BASE-T: built-in LAN port
Memory Protect ^{*1} <input type="checkbox"/> Internal Memory <input type="checkbox"/> Memory Card Memory	Check either check box to write-protect the memory from computers or other stations.
<input type="checkbox"/> Default Gateway ^{*1 *2}	Set the default gateway.
<input type="checkbox"/> Subnet Mask ^{*1 *2}	Set the subnet mask.

*1 Invalid if TS units or PCs at other ports are registered. Only valid when set as the local port IP of the TS unit.

*2 For more information on each setting item, see page App2-9.

Macro

This section explains the macro commands (SEND/EREAD/EWRITE) used for the Ethernet. For more information on macro commands, refer to the Macro Reference manual.

EREAD

EREAD F0 = F1 C : F2 F3

- Function: Read memory

This macro command is used to read the data of words starting from memory address F1 of the device that communicates with the TS series in the network table specified by F3 into memory address F0 of the device that communicates with the local port. The number of the words is specified in F2.

- Available memory

	Internal Memory	PLCn Memory	Memory Card	Constant
F0	⊙	⊙	⊙	
F1	⊙	⊙	⊙	
F2	⊙			○
F3	⊙			○

○: Setting enabled (indirect designation disabled)

⊙: Setting enabled (indirect designation enabled)

- Setting range

	Setting
F0	Top memory address of the target
F1	Top memory address of the source
F2	0 to 2000: The number of words to be transferred
F3	0 to 99: Network table number

- Example

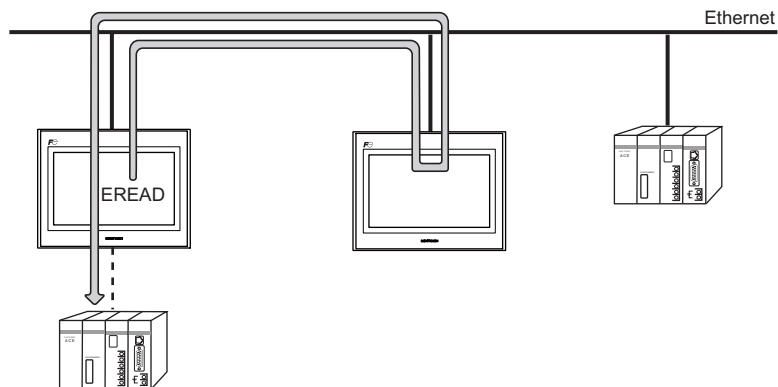

EWRITE

EWRITE F0 F1 = F2 C: F3

- Function: Write to memory

This macro command is used to write the data of words starting from memory address F2 of the device that communicates with the local port into memory address F0 of the device that communicates with the TS series in the network table specified by F1. The number of the words is specified in F3.

- Available memory

	Internal Memory	PLCn Memory	Memory Card	Constant
F0	⊙	⊙	⊙	
F1	⊙			○
F2	⊙	⊙	⊙	
F3	⊙			○

○: Setting enabled (indirect designation disabled)

⊙: Setting enabled (indirect designation enabled)

- Setting range

	Setting
F0	Top memory address of the target
F1	0 to 99: Transfer target (network table number)
F2	Top memory address of the source
F3	0 to 2000: The number of words to be transferred

- Example

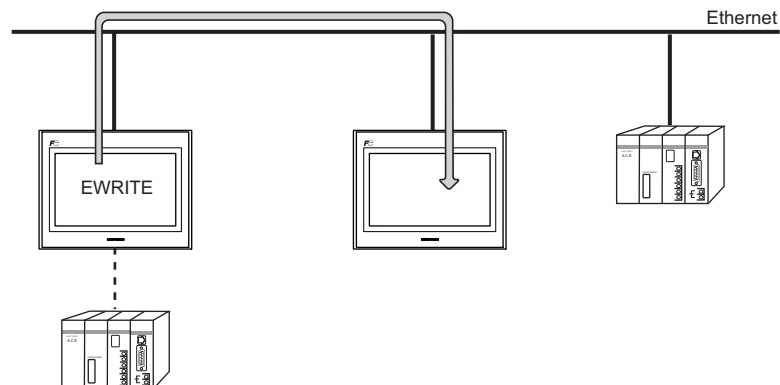

SEND

SEND F0 C: F1 TO: F2

- Function: Transfer to server

This macro command is used to transfer the data of words starting from the address specified in F0 to the server of the network table number in F2.

- Setting range

	Setting
F0	Top memory address of the target
F1	0 to 2000: The number of words to be transferred
F2	0 to 99: Transfer target (network table number)

- Available memory

	Internal Memory	PLCn Memory	Memory Card	Constant
F0	⊙	⊙	⊙	
F1	⊙			○
F2	⊙			○

○: Setting enabled (indirect designation disabled)

⊙: Setting enabled (indirect designation enabled)

- Example

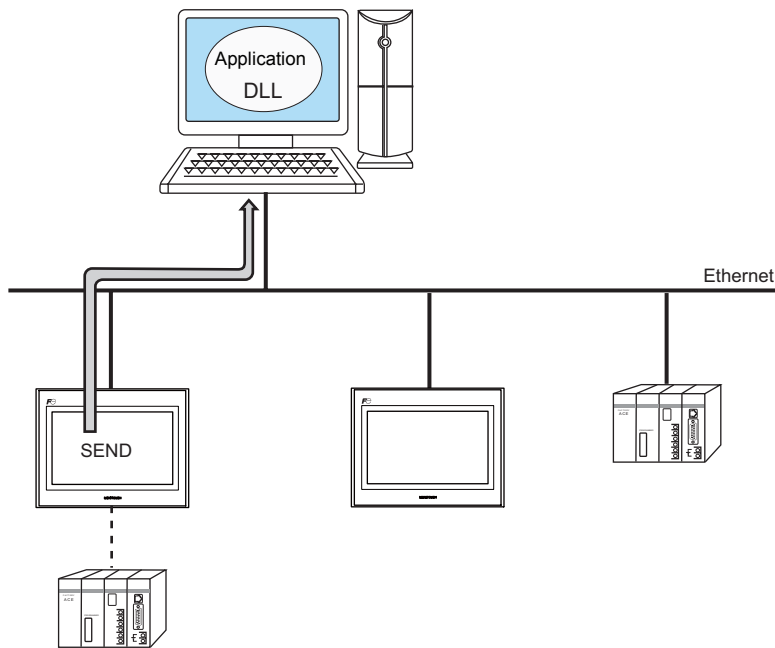

System Memory

The Ethernet status is output to the system memory (\$s) of the TS.
This section explains the memory addresses (\$s512 to 619) where the Ethernet status is output.
For other memory addresses, refer to the V8 Series Reference Manual.

List

Address	Contents
514	Macro Wait request (0: no request, 1: request made)
515	Execution result when a macro wait request is made
516	
517	
518	Ethernet status (for built-in LAN port)
519	
520	Network table 0 status
521	Network table 1 status
⋮	⋮
⋮	⋮
619	Network table 99 status
1400	Network table 100 status
1401	Network table 101 status
⋮	⋮
⋮	⋮
1555	Network table 255 status

Addresses

\$s514, 515

These addresses are related to MES and Ethernet macro commands [SEND], [ERead] and [EWRITE].

- \$s514: Set the presence or absence of a macro wait request.
 - [0]: No wait
When a macro command is executed, there is no wait for the completion of that command before the next macro command is executed.
 - [Other than 0]: Wait imposed
When a macro command is executed, the wait status continues until the command completes, and then the next macro command is executed.
 - * If the same port is accessed for execution of commands on one macro sheet, a value other than "0" must be set to impose a wait. If "0" (no wait) is set, the macro command executed next is deleted.
- \$s515: Stores the result of macro execution.
 - * If the data at \$s514 is "0" the information up to the command request is stored here. If the data at \$s514 is other than "0" the response from the request target is stored here.

Code	Contents	Solution
0	Normal	-
200 to 2000	Communication error	See "Communication Error".
-30	Timeout	Check if an error is occurring to the target TS.
-31	The number of words being sent exceeds the limit.	Check the number of words that can be sent in macro editing.
-32	Specified table not used	Check the setting on the network table.
-33	Cannot use the send command.	Check the macro command in macro editing.
-34	Specified table being used	Check that system memory address \$s514 is set. If not, reduce the frequency of communications.
-35	Cannot process due to short memory	Check the memory space at the target station.
-36	Illegal receive packet bytes	Check the requested number of words.
-37	Memory access error	Check the setting of the requested memory.
-38	Macro setting error	Check the macro setting.
-39	Command processing not possible at send target (local mode, communication error)	After recovery of the target TS series, execute the macro command again.

\$\$s518, 519

Stores the current status of the Ethernet.

- [0]: Normal
- [Other than 0]: Error
For more information, see the error codes (page App2-18).

\$\$s520 to 619, \$\$s1400 to 1555

Stores the statuses of network table No. 0 to 99.

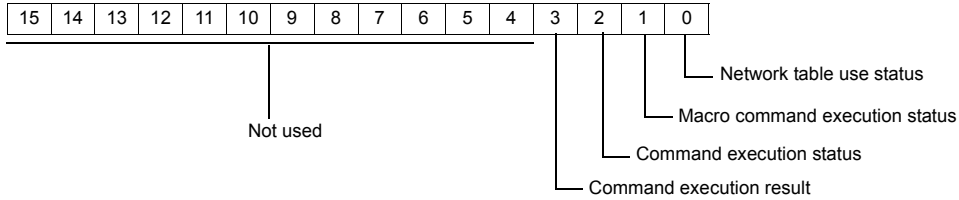

- Bit 0 (Network table use status)
[0]: Not used [1]: Used
For the current station, "0" (not used) is input.
- Bit 1 (Macro command execution status)
Stores the execution status of MES and Ethernet macro commands [SEND], [ERead], [EWRITE].
[0]: Waiting [1]: Executing
- Bit 2 (Command execution status)
Stores the execution status of MES and Ethernet commands from the server or other station.
[0]: Waiting [1]: Executing (read/write command)
- Bit 3 (Macro command execution result)
Stores the execution result of MES and Ethernet macro commands [SEND], [ERead], [EWRITE].
[0]: Normal [1]: Error
- Bits 4 to 15 (System reserved)
Not used at present. Always set "0".

Error Display

The errors displayed at the TS series in Ethernet communications are described here. For details on other errors, refer to the Reference Manual.

Communication Error

Ethernet error

The Ethernet status is stored in system memory address \$s518.

“Ethernet Error” occurs when a code other than “0” (normal) is stored in system memory address \$s518.

- RUN screen
- Communication error processing: Continued
- Communication error processing: Stopped

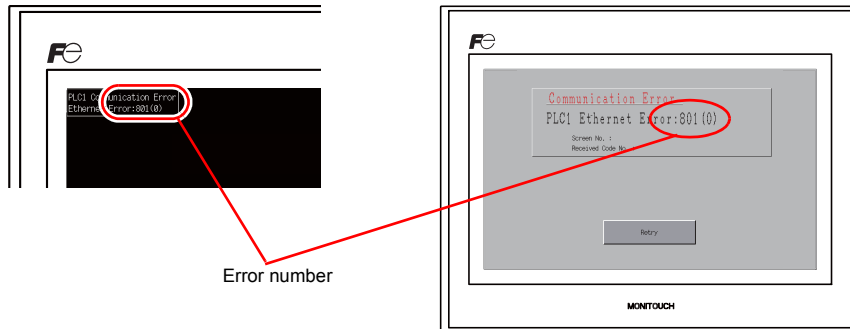

- Main Menu screen

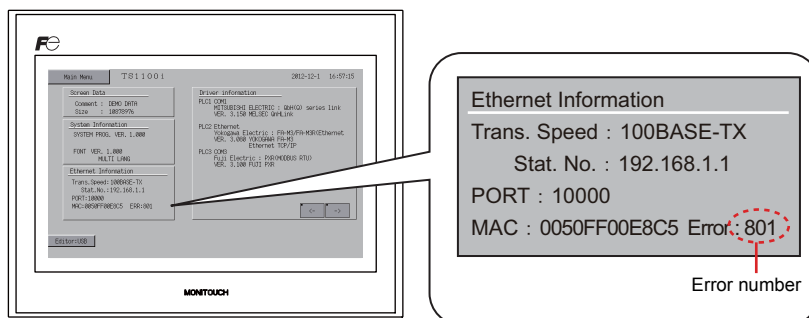

- Error number (This is the same as the value stored at system memory address \$s518.)

No.	Contents	Solution
201	Send error	Check that the setting on the target station is consistent with the network table setting.
203	TCP socket creation error	The TCP socket cannot be created. Turn the power off and back on again, or check the communication line status, e.g., if the port number is duplicated.
204	TCP connection over	The number of connections reaches the maximum (64), and no more connection is possible. Check the communication lines.
205	TCP connection error	Connection cannot be established. Check the communication lines, or turn the power off and on.
207	TCP send error	TCP communication has failed. Check the communication lines.
208	TCP connection interruption notification from the connected device	Check the connected device and communication lines.
261	Send processing full error	Sending process is disabled. Check the communication lines.
350	Send buffer full	The line is busy. Consult the network administrator of your company.
801	Receive processing error Link down error	Check the link confirmation LED on the hub or the communication unit. If the LED is not on, check cable connection and the port setting on the network table.
900	No IP address at local port	Check that the IP address of the local port is set on the network table.
901	Duplicated IP address error	Check if the same IP address is set on the network.
910	Local IP address setting error	The local IP address setting is not correct. Check if IP address and subnet mask settings are made properly.
911	Gateway setting error	The default gateway setting is not correct. Check if the default gateway setting is made properly for the specified IP address and subnet mask.
1005	Ethernet send registration error	Turn the power off and back on again.
1006	I/F unit unregistered interrupt	If the problem persists, the unit may be faulty. Contact your local distributor.
1007	ETHER_INIT_FAIL	Turn the power off and back on again. If the problem persists, the unit may be faulty. Contact your local distributor.
1202	MAC address error	The MAC address is not registered. Repair is necessary.
2001	Undefined error	Turn the power off and back on again. If the problem persists, the unit may be faulty. Contact your local distributor.

Appendix 3 System Memory

The TS series has system memories \$s and \$Pn.

\$s

The memory addresses \$s0 to 2047 (2 k words) are for system use. Data can be read from and write to these areas. For more information, refer to the V8 Series Reference Manual.

\$s0000 : \$s1023	1 k words (compatible with V7)
\$s1024 : \$s2047	1 k words (dedicated to TS)

\$Pn

This is the system memory for 8-way communications, and there are 512 words for each logical port. Refer to the next section for more information.

\$P1: 0000 : \$P1: 0511	PLC1 area
\$P2: 0000 : \$P2: 0511	PLC2 area
\$P3: 0000 : \$P3: 0511	PLC3 area
\$P4: 0000 : \$P4: 0511	PLC4 area
\$P5: 0000 : \$P5: 0511	PLC5 area
\$P6: 0000 : \$P6: 0511	PLC6 area
\$P7: 0000 : \$P7: 0511	PLC7 area
\$P8: 0000 : \$P8: 0511	PLC8 area

\$Pn List

The \$Pn list is presented below. Part of the information of logical ports PLC1/PLC2 can also be stored in \$s.*¹

\$Pn (n = 1 to 8)	\$s* ¹	Contents	Memory Type
000	111 (PLC1)	TS local port number Stores the local port number of the TS series. (Universal serial communication, slave communication, etc.)	← TS
:	-	:	
004	130 (PLC1)* ²	Modbus TCP/IP Sub Station communications Relay station No. designated memory When a relay station number is set with a MOV macro command, the error information of the sub station number that is connected to that relay station is stored in \$Pn010 to 025.	→ TS
:	-	:	
010	128 (PLC1)	Link down information (station No. 0 - 15) 0 : Normal 1 : Down	← TS
011	129 (PLC1)	Link down information (station No. 16 - 31) 0 : Normal 1 : Down	
012	114 (PLC1)	Link down information (station No. 32 - 47) 0 : Normal 1 : Down	
013	115 (PLC1)	Link down information (station No. 48 - 63) 0 : Normal 1 : Down	
014	116 (PLC1)	Link down information (station No. 64 - 79) 0 : Normal 1 : Down	
015	117 (PLC1)	Link down information (station No. 80 - 95) 0 : Normal 1 : Down	
016	118 (PLC1)	Link down information (station No. 96 - 111) 0 : Normal 1 : Down	
017	119 (PLC1)	Link down information (station No. 112 - 127) 0 : Normal 1 : Down	
018	120 (PLC1)	Link down information (station No. 128 - 143) 0 : Normal 1 : Down	
019	121 (PLC1)	Link down information (station No. 144 - 159) 0 : Normal 1 : Down	
020	122 (PLC1)	Link down information (station No. 160 - 175) 0 : Normal 1 : Down	
021	123 (PLC1)	Link down information (station No. 176 - 191) 0 : Normal 1 : Down	
022	124 (PLC1)	Link down information (station No. 192 - 207) 0 : Normal 1 : Down	
023	125 (PLC1)	Link down information (station No. 208 - 223) 0 : Normal 1 : Down	
024	126 (PLC1)	Link down information (station No. 224 - 239) 0 : Normal 1 : Down	
025	127 (PLC1)	Link down information (station No. 240 - 255) 0 : Normal 1 : Down	
:	-	:	
099	-	Error information hold (page App3-5) \$Pn: Setting for the update timing of the 010 to 025 link down information 0: Always updated with the latest information Other than 0: Only updated when a communication error occurs	→ TS
100	730 (PLC2)	Error status Station No. 00 status (page App3-5)	← TS
101	731 (PLC2)	Error status Station No. 01 status (page App3-5)	
102	732 (PLC2)	Error status Station No. 02 status (page App3-5)	
103	733 (PLC2)	Error status Station No. 03 status (page App3-5)	
104	734 (PLC2)	Error status Station No. 04 status (page App3-5)	
105	735 (PLC2)	Error status Station No. 05 status (page App3-5)	
106	736 (PLC2)	Error status Station No. 06 status (page App3-5)	
107	737 (PLC2)	Error status Station No. 07 status (page App3-5)	
108	738 (PLC2)	Error status Station No. 08 status (page App3-5)	
109	739 (PLC2)	Error status Station No. 09 status (page App3-5)	
110	740 (PLC2)	Error status Station No. 10 status (page App3-5)	
:	:	:	
120	750 (PLC2)	Error status Station No. 20 status (page App3-5)	
:	:	:	
130	760 (PLC2)	Error status Station No. 30 status (page App3-5)	
131	761 (PLC2)	Error status Station No. 31 status (page App3-5)	
132	820 (PLC2)	Error status Station No. 32 status (page App3-5)	
133	821 (PLC2)	Error status Station No. 33 status (page App3-5)	
:	:	:	
140	828 (PLC2)	Error status Station No. 40 status (page App3-5)	

\$Pn (n = 1 to 8)	\$s*1	Contents	Memory Type
:	:	:	
150	838 (PLC2)	Error status Station No. 50 status (page App3-5)	
:	:	:	
160	848 (PLC2)	Error status Station No. 60 status (page App3-5)	
:	:	:	
170	858 (PLC2)	Error status Station No. 70 status (page App3-5)	
:	:	:	
180	868 (PLC2)	Error status Station No. 80 status (page App3-5)	
:	:	:	
190	878 (PLC2)	Error status Station No. 90 status (page App3-5)	← TS
:	:	:	
199	887 (PLC2)	Error status Station No. 99 status (page App3-5)	
200	-	Error status Station No. 100 status (page App3-5)	
:	:	:	
350	-	Error status Station No. 250 status (page App3-5)	
:	:	:	
355	-	Error status Station No. 255 status (page App3-5)	
356	-	Device memory map 0 Status	
357	-	Device memory map 0 Error code 1	
358	-	Device memory map 0 Error code 2	
359-361	-	Device memory map 1 Status, error code	
362-364	-	Device memory map 2 Status, error code	
365-367	-	Device memory map 3 Status, error code	
368-370	-	Device memory map 4 Status, error code	
371-373	-	Device memory map 5 Status, error code	
374-376	-	Device memory map 6 Status, error code	
377-379	-	Device memory map 7 Status, error code	
380-382	-	Device memory map 8 Status, error code	
383-385	-	Device memory map 9 Status, error code	← TS
386-388	-	Device memory map 10 Status, error code	
389-391	-	Device memory map 11 Status, error code	
392-394	-	Device memory map 12 Status, error code	
395-397	-	Device memory map 13 Status, error code	
398-400	-	Device memory map 14 Status, error code	
401-403	-	Device memory map 15 Status, error code	
404-406	-	Device memory map 16 Status, error code	
407-409	-	Device memory map 17 Status, error code	
410-412	-	Device memory map 18 Status, error code	
413-415	-	Device memory map 19 Status, error code	
416-418	-	Device memory map 20 Status, error code	
419-421	-	Device memory map 21 Status, error code	
422-424	-	Device memory map 22 Status, error code	
425-427	-	Device memory map 23 Status, error code	
428-430	-	Device memory map 24 Status, error code	
431-433	-	Device memory map 25 Status, error code	
434-436	-	Device memory map 26 Status, error code	
437-439	-	Device memory map 27 Status, error code	← TS
440-442	-	Device memory map 28 Status, error code	
443-445	-	Device memory map 29 Status, error code	
446-448	-	Device memory map 30 Status, error code	
449	-	Device memory map 31 Status	
450	-	Device memory map 31 Error code 1	
451	-	Device memory map 31 Error code 2	
:	:	:	
493	762 (PLC2)*3	Device memory map reading prohibited flag (page App3-7) 0: Periodical reading/synchronized reading executed Other than 0: Periodical reading/synchronized reading stopped	
494	763 (PLC2)*3	Forced execution of the device memory map TRL_READ/TBL_WRITE macro Setting for macro operation when there is a station with communication down 0: The macro is not executed in relation to any of the stations. Other than 0: The macro is executed in relation to connected stations.	→ TS
495	764 (PLC2)*3	Device memory map writing prohibited flag (page App3-7) 0: Periodical writing/synchronized writing executed Other than 0: Periodical writing/synchronized writing stopped	

\$Pn (n = 1 to 8)	\$s*1	Contents	Memory Type
:	-	:	
500	800 (PLC3)	Memory for Modbus slave communications Used for reference table No. and free area 31 reference memory setting \$Pn500 to 505 are exclusively for monitoring: \$s800 to 805 are used for writing from the Modbus master. Refer to the Modbus Slave Communication manual.	→ TS
501	801 (PLC3)		
502	802 (PLC3)		
503	803 (PLC3)		
504	804 (PLC3)		
505	805 (PLC3)		
:	:	:	
508	765 (PLC2)	Error response code (page App3-8) If "800BH" (error code received) is stored for the error status (\$Pn100 to 355), it is possible to check the error code.	← TS
509	766 (PLC2)		
510	767 (PLC2)		
511	768 (PLC2)		

- *1 For PLC1, check the [System memory (\$s) V7 Compatible] check box in the [Detail] tab window of the [Device Connection Setting] dialog. The same information is stored in the \$P1 memory and \$s.
- *2 If designating the relay station number using \$s130, check the [System memory (\$s) V7 Compatible] check box in the [Detail] tab window of the [Device Connection Setting] dialog for PLC1. \$SP1: 004 cannot be used in this case.
- *3 If executing device memory map control using \$s762, \$s763 and \$s764, check the [System memory (\$s) V7 Compatible] check box in the [Detail] tab window of the [Device Connection Setting] dialog for PLC2. Note that \$P2: 493/494/495 cannot be used in this case.

- Solution

- 1) Check if the communication settings of the TS series and the connected device are matched.
- 2) Check the cable connection.
- 3) Data may be disrupted because of noise. Fix noise.

If you still cannot solve the error even after following the suggestions above, contact your local distributor.

\$Pn: 356 to 451

This memory is valid when an Omron's ID controller (V600/620/680) is connected with [Guarantee synchronism of the data] checked on the [Device Memory Map Setting] dialog.

- Status (\$Pn 356, 359, ...)

The execution status of the device memory map is stored here.

The bit is set (ON) when reading or writing of the first data in the device memory map is correctly finished.

When the control memory (command bit) is set (ON), the bit is reset.

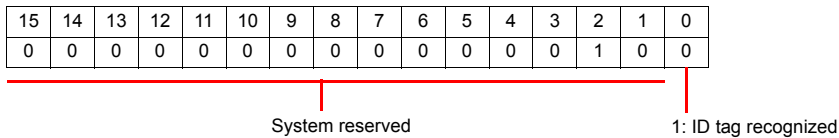

- Error code 1 (\$Pn 357, 360, ...)

An error code is stored when an error occurs in the reading or writing of data in the device memory map.

If multiple errors occur in the device memory map, the last error code is stored.

When the control memory (command bit) is set (ON), the bit is reset.

Code (HEX)	Contents
FFFFH	Time-out
8001H	Check code error
8002H	Data error
800BH	Receives the error code from the connected device

Errors other than the above are stored as shown below.

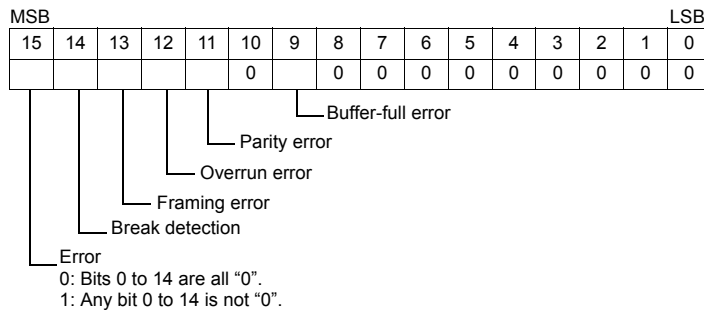

- Error code 2 (\$Pn 358, 361, ...)

The exit code is stored here when "800BH" of error code 1 is stored.

Exit Code (HEX)	Contents
10	Parity error
11	Framing error
12	Overrun error
13	FCS error
14	Format error, execution status error
18	Frame length error
70	Tag communication error
71	Inconsistency error
72	Tag absence error
76	Copy error
7A	Address error
7C	Antenna disconnection error
7D	Write protect error

Exit Code (HEX)	Contents	
75	Tag memory warning	Data check command Exit code stored when the writing count management command has been successfully processed (without any error)
76		Data check command Exit code stored when the writing count management command has been abnormally processed (comparison error, excessive writing counts)
92	System error	Abnormal mains voltage at antenna
93		Internal memory error

\$Pn: 493, 495

Periodical or synchronized reading set in the [Device Memory Map Setting] dialog is suspended.

- 0: Periodical/synchronized reading is performed.
- Other than 0: Periodical/synchronized reading is suspended.

• Example: Periodical reading

If periodical reading of the device memory map is performed while the PLC2 memory is being accessed using a macro command, the macro execution will be delayed (Fig. a). To avoid this, periodical reading can be suspended using memory address \$Pn493 (Fig. b).

(Fig. a)

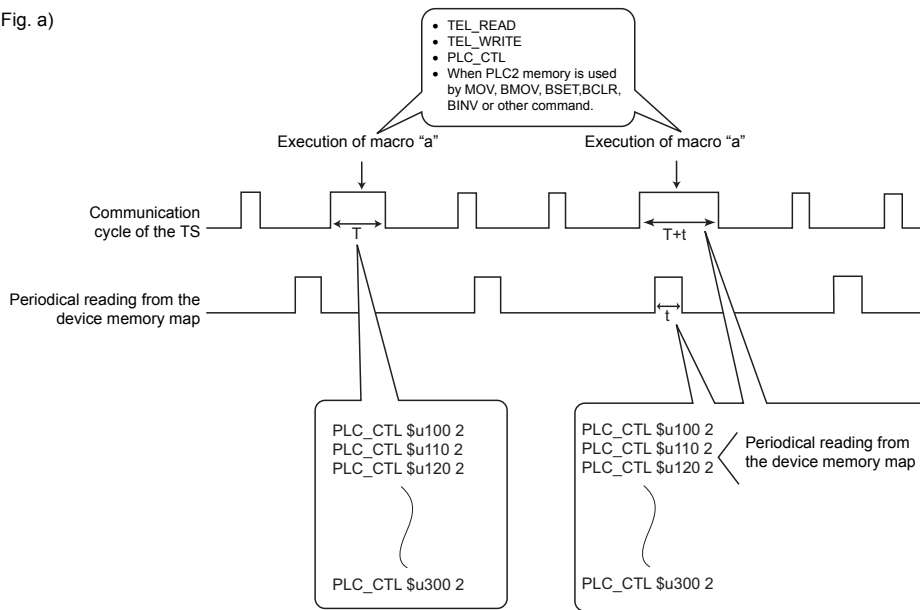

(Fig. b)

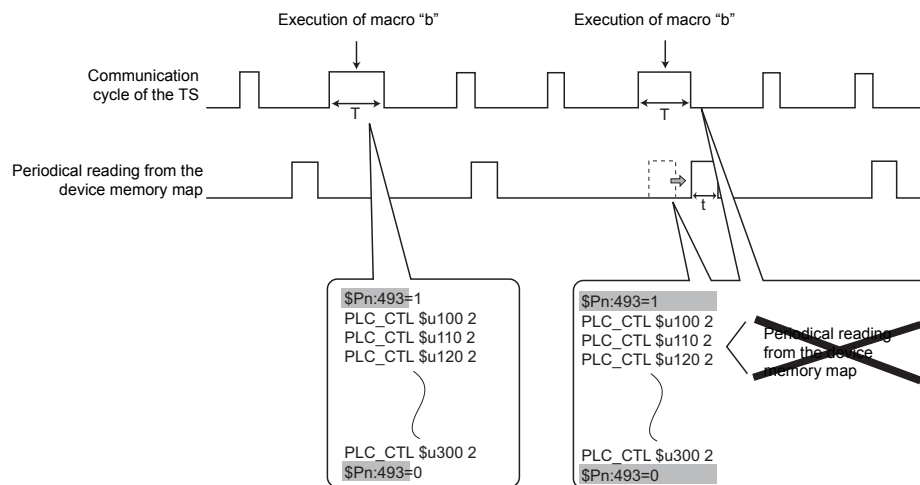

\$Pn: 508 to 511

If "800BH" is stored for the error status information (\$Pn: 100 to 355), on transferring the data of that station number to any internal memory address, the reception code will be obtained at \$Pn: 508 to 511.

Notes on Use

- Use \$u/\$T as the target internal memory.
- Use the macro command MOV (W). MOV (D) cannot be used.
- "0" is stored for devices that have no expansion error code.

- Example PLC2: Fuji Electric PXR station No. 1

- 1) On receipt of an error code at station No. 1 of PLC2, "800BH" is stored in \$P2: 101.

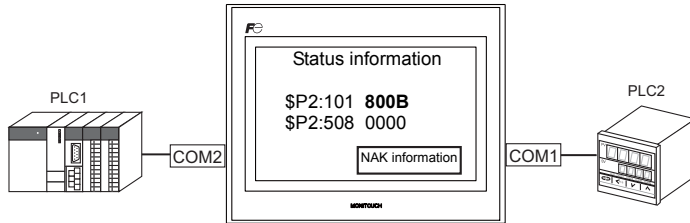

- 2) The data of \$P2: 101 is transferred to \$u1000 by a MOV command.
\$u1000 = \$P2: 101 (W)

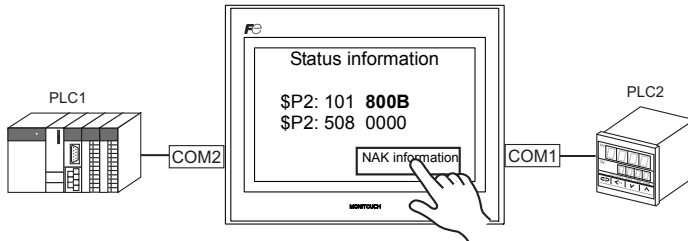

- 3) The reception code is stored in \$P2: 508.
\$P2:508 = 0002H

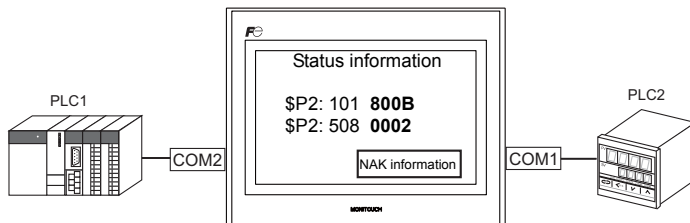

- 4) The PXR manual shows that code 002H means "memory address range exceeded". Amend the screen data address designation.

Appendix 4 n : 1 Connection

Appendix 4.1 Multi-link2

- One PLC is connected to a maximum of four TS units.
- Multi-link2 enables you to establish an original network consisting of a master TS of local port No. 1 and slave TS units of local port Nos. 2, 3, and 4. The master TS communicates with the PLC directly, and the slave TS units communicate with the PLC through the master.

- Connection example 1:

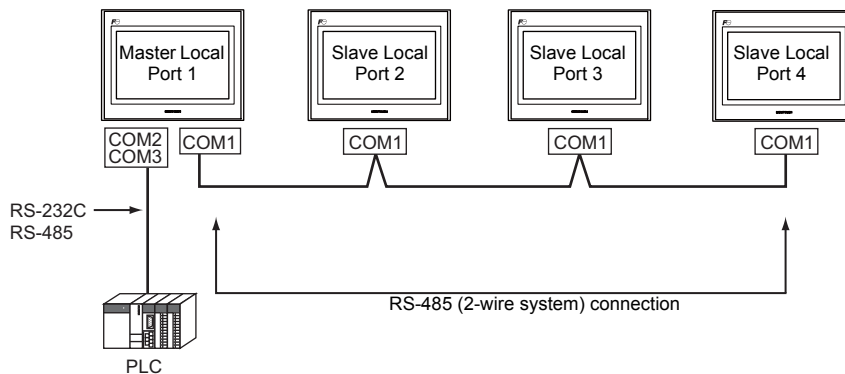

- Connection example 2:

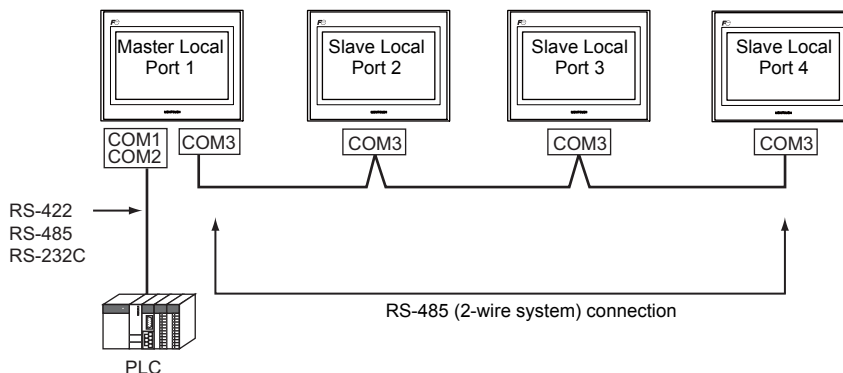

- You can make settings for multi-link2 in the [Communication Setting] tab window for PLC1. Therefore, multi-link2 connection is not possible concurrently with a network connection that uses a "CU-xx" communication interface unit.
- Multi-link2 enables PLC1 memory data to be shared among the TS units. However, sharing data of PLC2 - PLC8 is not possible.
- V7 and V6 cannot be concurrently used with the TS series. However, S8 and V8 can be used with the TS series.
 - * The V7 and V6 series can be connected together with some PLC models. For more information on the available PLC models, refer to page App4-5.
- The communication speed between the master and the PLC depend on the setting made on the PLC. The maximum communication speed between TS units is 115 kbps, which is higher than the one available with multi-link connection described in "Appendix 4.4 Multi-link".
- For PLCs that support multi-link2 connection, see the list provided at the end of this manual. The connection between the master and the PLC is the same as the one for 1 : 1 connection. RS-485 (2-wire system) connection is adopted to connect a master with slaves.

System Configuration and Wiring Diagram

Connection Method 1

Connecting the COM1 port of the master with the COM1 ports of the slaves

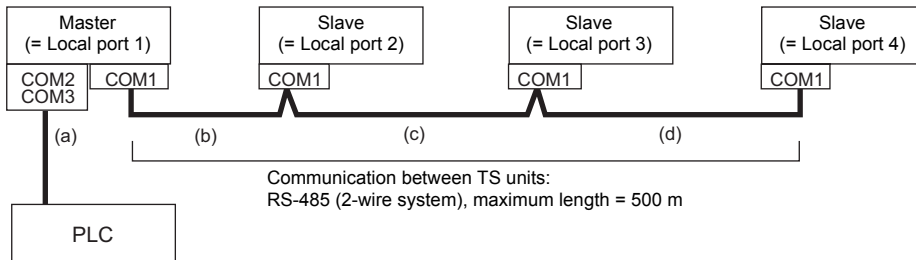

(a) Master ↔ PLC connection

Select either connection port COM2 or COM3.

The communication settings and connection method are the same as that for 1 : 1 connection.

(b)(c)(d) Master ↔ slaves connection

Use the RS-485 (2-wire system) connection. Use twisted-pair cables of 0.3 mm sq or greater. The maximum length of the wiring is 500 m.

Wiring diagram

- DIPSW No. 2, 3: ON (COM1 RS-485: 2-wire connection)
- DIPSW No. 7: Terminal resistance setting

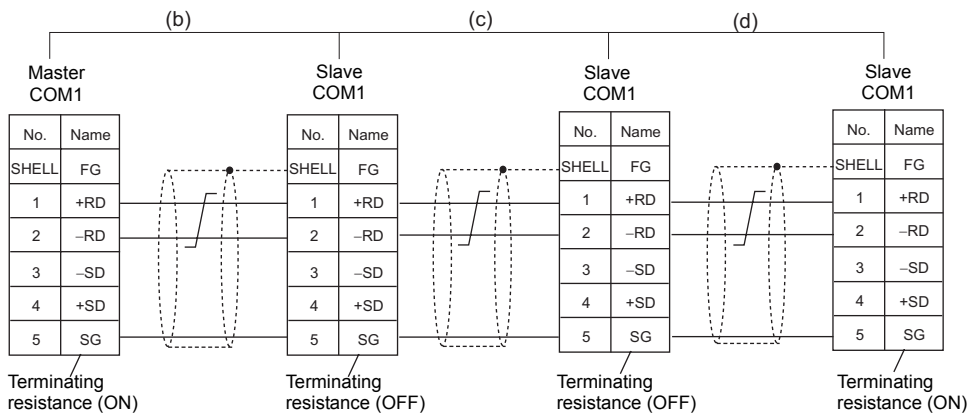

* For master-to-PLC connection via COM3, also set the DIPSW 8 to ON on the master.

* As a measure against noise, connect the frame ground terminal of each TS series at one side only.

Connection Method 2

Connecting the COM3 port of the master with the COM3 ports of the slaves

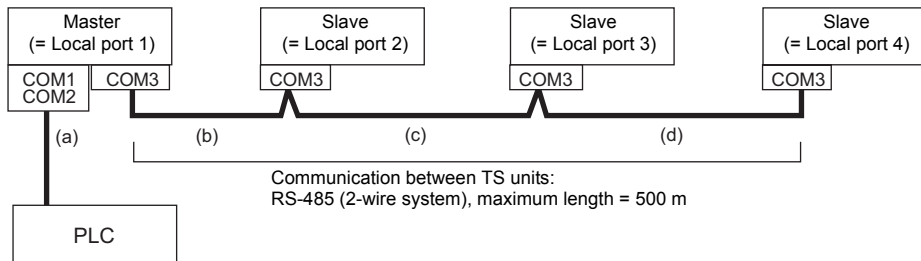

(a) Master ↔ PLC connection

Select either connection port COM1 or COM2.

The communication settings and connection method are the same as that for 1 : 1 connection.

(b)(c)(d) Master ↔ slaves connection

Use the RS-485 (2-wire system) connection. Use twisted-pair cables of 0.3 mm sq or greater. The maximum length of the wiring is 500 m.

Wiring diagram

- DIPSW No. 8: Terminating resistance setting

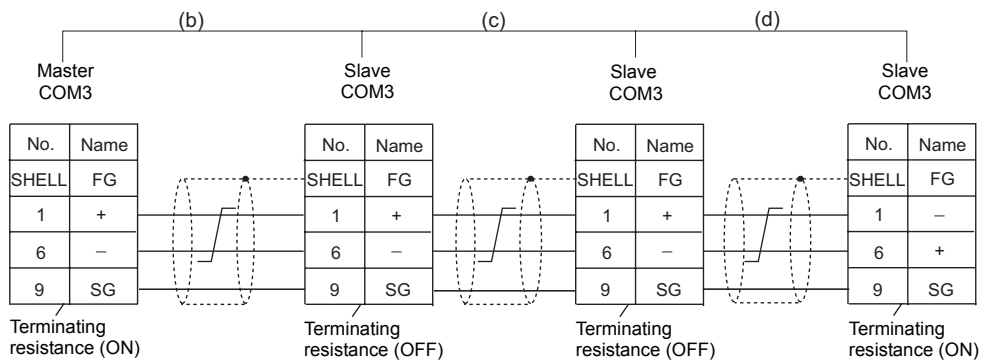

* For master-to-PLC connection via COM1 based on RS-422 (4-wire system), also set the DIPSW 6 and 7 to ON on the master.
 For master-to-PLC connection via COM1 based on RS-485 (2-wire system), also set the DIPSW2, 3, and 7 to ON on the master.

* As a measure against noise, connect the frame ground terminal of each TS series at one side only.

Setting on the Editor

The settings for multi-link2 are covered below. The differences with respect to a 1 : 1 connection and the points where care is required are explained here.

Communication Setting

[System Setting] → [Device Connection Setting] → [PLC1] → [Communication Setting]

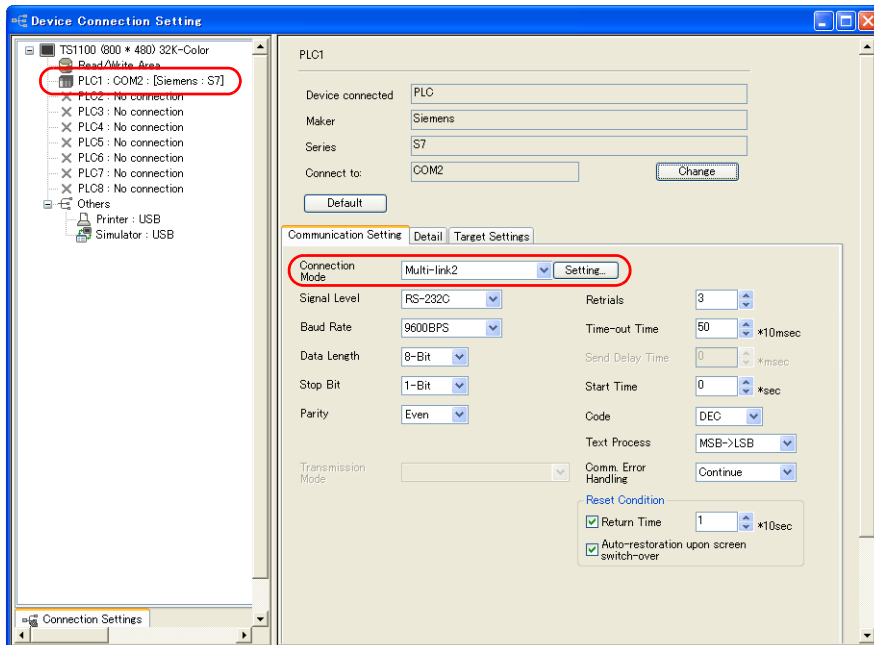

Connection Mode	Multi-link2
-----------------	-------------

Multi-link2

Click the [Setting] button next to [Connection Mode: Multi-link2] to display the [Multi-link2] dialog, then make the necessary settings in this dialog.

For a master, set all of the items. For a slave, set only those items marked “◆”.

- Master

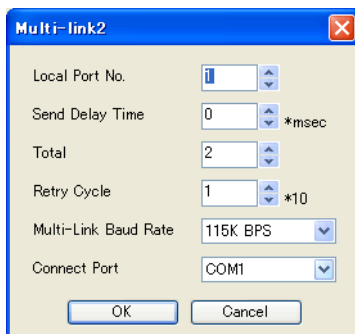

- Slave

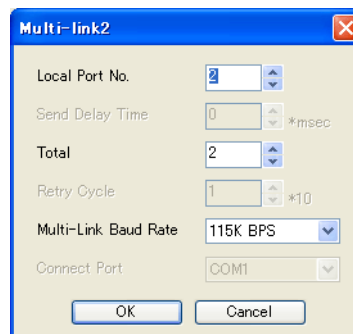

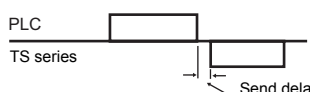
Local Port No. ◆	1 to 4 Specify a port number of the TS series. For the master set “1”, and for the slaves set “2” to “4”. Note that if the port number specified is the same as that already set for another TS unit, the system will not operate correctly.
Send Delay Time	Specify a delay time that elapses before TS sends the next command after receiving data from the PLC. Normally use the default setting (0). 
Total ◆	2 to 4 Set the total number of TS units connected in the “multi-link2” connection. The setting must be the same as other TS series on the same communication line.

Retry Cycle	Set the number of cycles before the master sends an inquiry for restoration to the slave that has a communication problem (= system down). When a slave has a problem, it is temporarily removed from the communication targets, and the master sends an inquiry for restoration every number of cycles specified for [Retry Cycle]. This setting does not affect the communication speed if no problem is occurring on the slave; however, if there is any problem, it does affect the communication speed. When the setting value is small: It will not take a long time before restoration. When the setting value is large: It will take a longer time before restoration.
Multi-Link Baud Rate◆	4800, 9600, 19200, 38400, 57600, 115 kbps Set the baud rate between TS series units. The setting must be the same as other TS series units on the same communication line.
Connect Port	COM1/COM3 Set the port to be connected to slaves.

Detailed Setting

Multi-link2 with V7/V6	Check this box when multi-link2 is used for connecting the TS together with the V6* or V7.
------------------------	--

*** When connecting the V6 series together with the TS series, note the following points:**

- When V609E, V606e, V606, or V606i is connected as a master, only V609E, V606e, V606, or V606i can be connected as a slave. The TS series cannot be used as a slave in this case.
- Multi-link2 cannot be used for the V6 series with which temperature control network/PLC2Way is used.
- Multi-link2 may not be used on the V6 series depending on its hardware version. For more information, refer to the V6 Series Hardware Specifications manual.

Available PLC models

The V7 and V6 series can be connected together with the following PLC models.

Manufacturer	Model Selection for [Device Connection Setting]
MITSUBISHI ELECTRIC	A series link QnA series link QnH (Q) series link QnH (Q) series CPU QnU series CPU Q00J/00/01CPU QnH (Q) series link (multi CPU) QnH (Q) series CPU (multi CPU) FX2N/1N series CPU FX1S series CPU FX series link (A protocol) FX3U/3UC/3G series CPU FX3U/3UC/3G series link (A protocol)
OMRON	SYSMAC C SYSMAC CV SYSMAC CS1/CJ1
GE Fanuc	90 series (SNP-X)
KEYENCE	KV-700 KV-1000 KV-3000/5000

Communication Error

- If the master station has a communication error, the master and slave stations do not work, and as a result, "Communication Error Time-Out" is displayed.
If a slave station becomes faulty, the communication error (Data Loading...) occurs only on this station.

Appendix 4.2 Multi-link2 (Ethernet)

- One PLC is connected to a maximum of 32 units of the TS series.
- Multi-link2 (Ethernet) enables you to establish an original network consisting of a master TS of local port No. 1 and slave TS units of local port Nos. 2 to 32. The master TS communicates with the PLC directly, and the slave TS units communicate with the PLC through the master.
 - Connection example

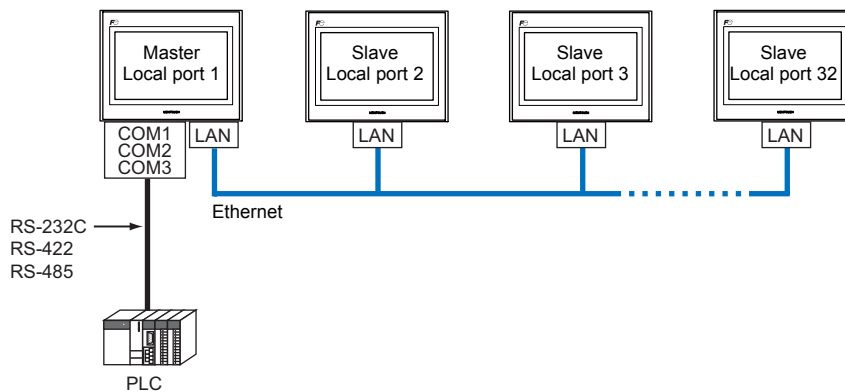

- You can make settings for multi-link2 (Ethernet) in the [Communication Setting] tab window for PLC1.
- Multi-link2 (Ethernet) enables PLC1 memory data to be shared among the TS units. However, sharing data of PLC2 - PLC8 is not possible.
- S8, V7, and V6 cannot be concurrently used with the TS series. However, V8 can be used with the TS series.
- The communication speed between the master station and the PLC depends on the setting made on the PLC; however, communication among TS units is performed via Ethernet, thus, high-speed communication is possible among them.
- For PLCs that support multi-link2 (Ethernet) connection, see the list provided at the end of this manual. The method for connecting a master TS and a PLC is the same as that for 1 : 1 connection. Ethernet connection is adopted to connect a master with slaves.

Available Models

Available TS models

Model	Communication Port between Master and Slave	Protocol
TS1100i TS1070i	Built-in LAN	UDP/IP

Available PLC models

For details, see “Connection Compatibility List” provided at the end of this manual.

Setting on the Editor

The settings for multi-link2 (Ethernet) are covered below. The differences with respect to a 1 : 1 connection and the points where care is required are explained here.

Communication Setting

[System Setting] → [Device Connection Setting] → [PLC1] → [Communication Setting]

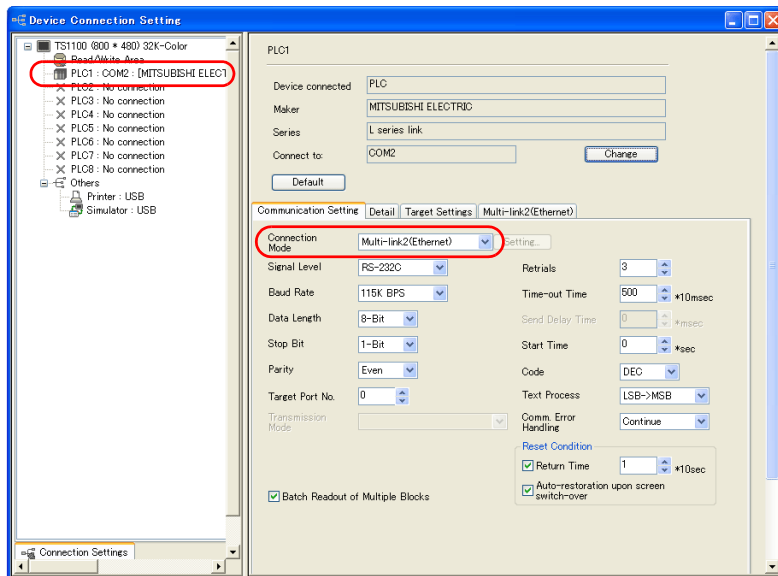

Connection Mode	Multi-link2 (Ethernet)
-----------------	------------------------

Multi-link2 (Ethernet)

Make settings on the [Multi-link2 (Ethernet)] tab window.

- Master

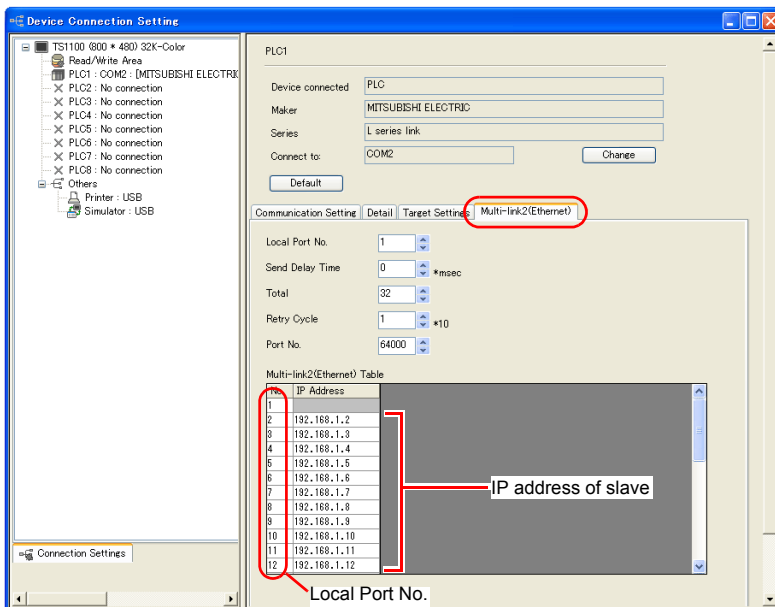

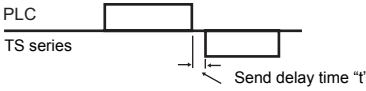
Local Port No.	1 (fixed)
Send Delay Time	Specify a delay time that elapses before TS sends the next command after receiving data from the PLC. Normally use the default setting (0). 

Total	2 to 32 Set the total number of TS units connected in the "multi-link2 (Ethernet)" connection. The setting must be the same as other TS series on the same communication line.
Retry Cycle	Set the number of cycles before the master sends an inquiry for restoration to the slave that has a communication problem (= system down). When a slave has a problem, it is temporarily removed from the communication targets, and the master sends an inquiry for restoration every number of cycles specified for [Retry Cycle]. This setting does not affect the communication speed if no problem is occurring on the slave; however, if there is any problem, it does affect the communication speed. When the setting value is small: It will not take a long time before restoration. When the setting value is large: It will take a longer time before restoration.
Port No.	Set a value in the range from 1024 to 65535. (Excluding 8001 and 8020) Default: 64000 * Set the same port number for all master and slave stations.
Multi-link2 (Ethernet) Table	Set the IP addresses of all TS units used as slave to respective local port numbers.

• Slave

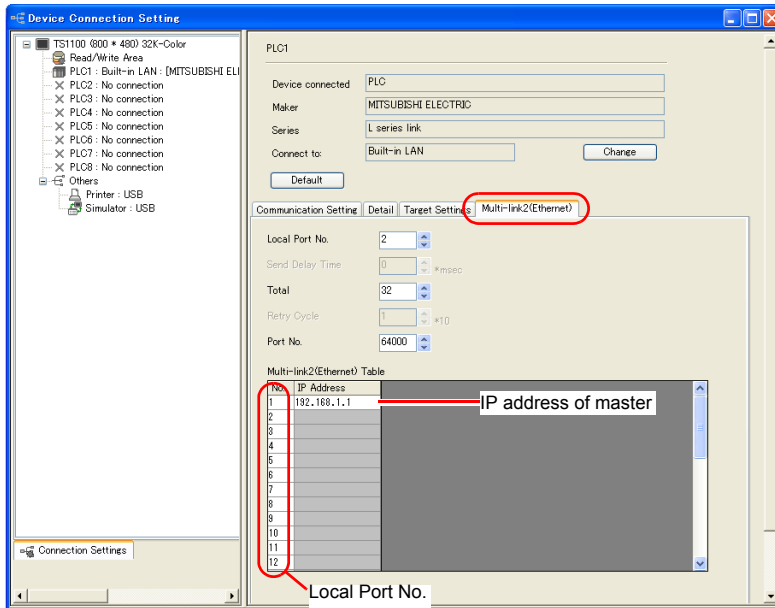

Local Port No.	2 to 32 Note that if the port number specified is the same as that already set for another TS unit, the system will not operate correctly.
Total	2 to 32 Set the total number of TS units connected in the "multi-link2 (Ethernet)" connection. The setting must be the same as other TS series on the same communication line.
Port No.	Set a value in the range from 1024 to 65535. (Excluding 8001 and 8020) Default: 64000 * Set the same port number for all master and slave stations.
Multi-link2 (Ethernet) Table	Set the IP address of the master TS for No. 1.

Communication Error

If the master station has a communication error, the master and slave stations do not work, and as a result, "Communication Error Time-Out" is displayed.

If a slave station becomes faulty, the communication error (Data Loading...) occurs only on this station.

Appendix 4.3 1 : n Multi-link2 (Ethernet)

- A maximum of 32 units of TS series can be connected to a maximum of 31 units of PLCs.
- 1 : n multi-link2 (Ethernet) enables you to establish an original network consisting of a master TS of local port No. 1 and slave TS units of local port Nos. 2 to 32. The master TS communicates with the PLC directly, and the slave TS units communicate with the PLC through the master.

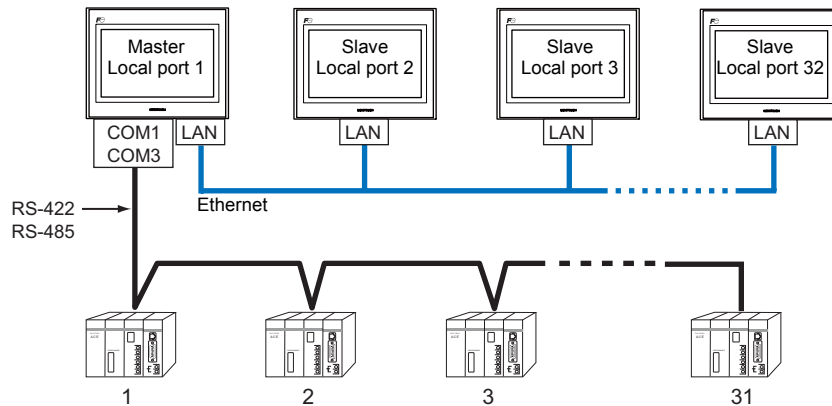

- You can make settings for 1 : n multi-link2 (Ethernet) in the [Communication Setting] tab window for PLC1.
- 1 : n multi-link2 (Ethernet) enables PLC1 memory data to be shared among the TS units. However, sharing data of PLC2 - PLC8 is not possible.
- S8, V7, and V6 cannot be concurrently used with the TS series. However, V8 can be used with the TS series.
- The communication speed between the master station and the PLC depends on the setting made on the PLC; however, communication among TS units is performed via Ethernet, thus, high-speed communication is possible among them.
- For PLCs that support 1 : n multi-link2 (Ethernet) connection, see the list provided at the end of this manual. The method for connecting a master TS and a PLC is the same as that for 1 : n connection. Ethernet connection is adopted to connect a master with slaves.

Available Models

Available TS models

Model	Communication Port between Master and Slave	Protocol
TS1100i TS1070i	Built-in LAN	UDP/IP

Available PLC models

For details, see "Connection Compatibility List" provided at the end of this manual.

Setting on the Editor

The settings for 1 : n multi-link2 (Ethernet) are covered below. The differences with respect to a 1 : n connection and the points where care is required are explained here.

Communication Setting

[System Setting] → [Device Connection Setting] → [PLC1] → [Communication Setting]

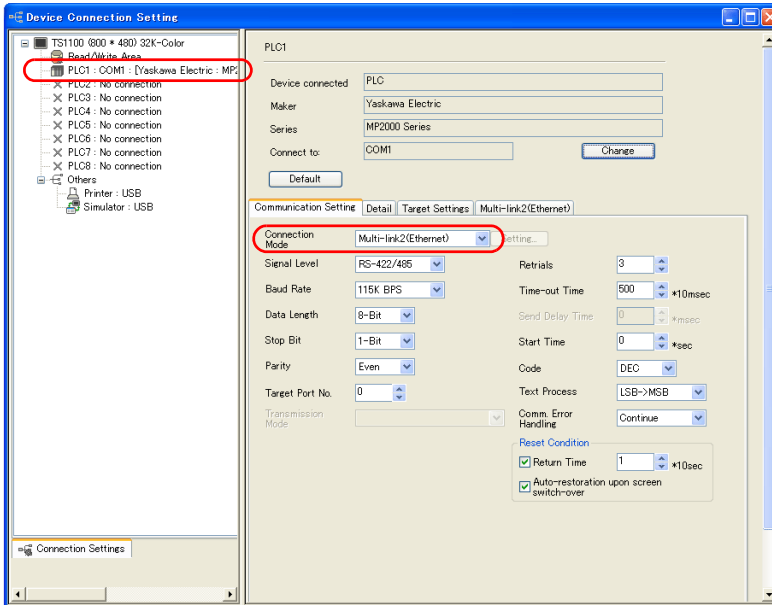

Connection Mode	1 : n Multi-link2 (Ethernet)
-----------------	------------------------------

Multi-link2 (Ethernet)

Make settings on the [Multi-link2 (Ethernet)] tab window.

- Master

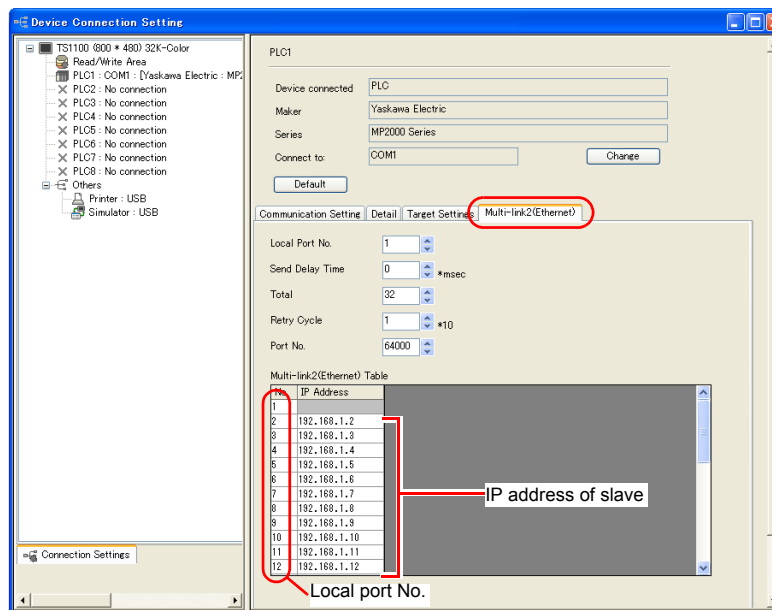

Local Port No.	1 (fixed)
Send Delay Time	<p>Specify a delay time that elapses before TS sends the next command after receiving data from the PLC. Normally use the default setting (0).</p>

Total	2 to 32 Set the total number of TS units connected in the "1 : n multi-link2 (Ethernet)" connection. The setting must be the same as other TS series on the same communication line.
Retry Cycle	Set the number of cycles before the master sends an inquiry for restoration to the slave that has a communication problem (= system down). When a slave has a problem, it is temporarily removed from the communication targets, and the master sends an inquiry for restoration every number of cycles specified for [Retry Cycle]. This setting does not affect the communication speed if no problem is occurring on the slave; however, if there is any problem, it does affect the communication speed. When the setting value is small: It will not take a long time before restoration. When the setting value is large: It will take a longer time before restoration.
Port No.	Set a value in the range from 1024 to 65535. (Excluding 8001 and 8020) Default: 64000 * Set the same port number for all master and slave stations.
Multi-link2 (Ethernet) Table	Set the IP addresses of all TS units used as slave to respective local port numbers.

- Slave

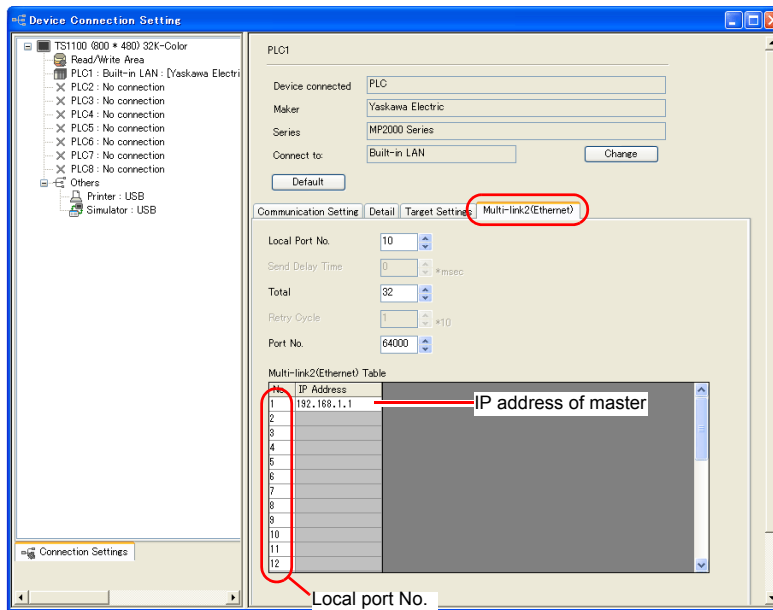

Local Port No.	2 to 32 Note that if the port number specified is the same as that already set for another TS unit, the system will not operate correctly.
Total	2 to 32 Set the total number of TS units connected in the "1 : n multi-link2 (Ethernet)" connection. The setting must be the same as other TS series on the same communication line.
Port No.	Set a value in the range from 1024 to 65535. (Excluding 8001 and 8020) Default: 64000 * Set the same port number for all master and slave stations.
Multi-link2 (Ethernet) Table	Set the IP address of the master TS for No. 1.

Communication Error

If the master station has a communication error, the master and slave stations do not work, and as a result, "Communication Error Time-Out" is displayed.

If a slave station becomes faulty, the communication error (Data Loading...) occurs only on this station.

Appendix 4.4 Multi-link

- One PLC can be connected to a maximum of 31 TS units. In addition to TS, connecting to S8, V8, V7 or V6 is also possible.

- Connection example 1:

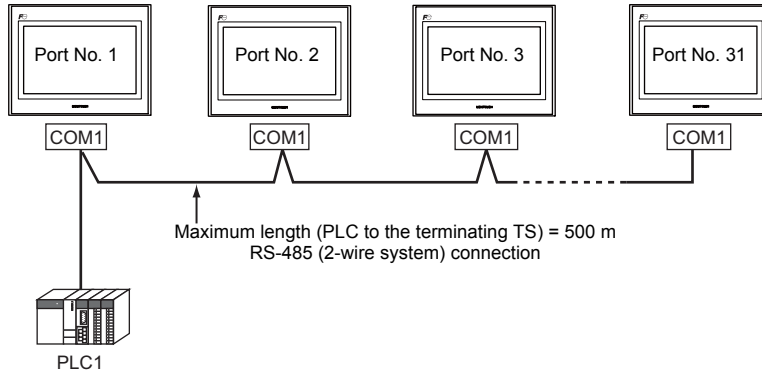

- Connection example 2:

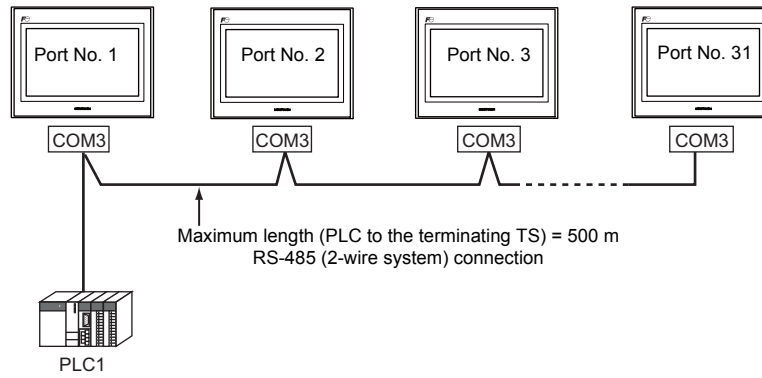

- Make multi-link settings at the PLC1. For connection with the TS series, select either physical port COM1 or COM3. Use COM1 for the S8 series and CN1 for the V8, V7, or V6 series.
- Only a PLC for the signal level RS422/RS485 and with a port number is available. RS-485 (2-wire system) connection is adopted to connect a TS-series unit and a PLC. For available models, see the list at the end of this manual.
- Use twisted-pair cables of 0.3 mm sq. or greater between terminal blocks.

Wiring Diagrams

When Connected at COM1:

- DIPSW No.2, 3: ON (RS-485: 2-wire system)
- DIPSW No. 7: Terminating resistance setting

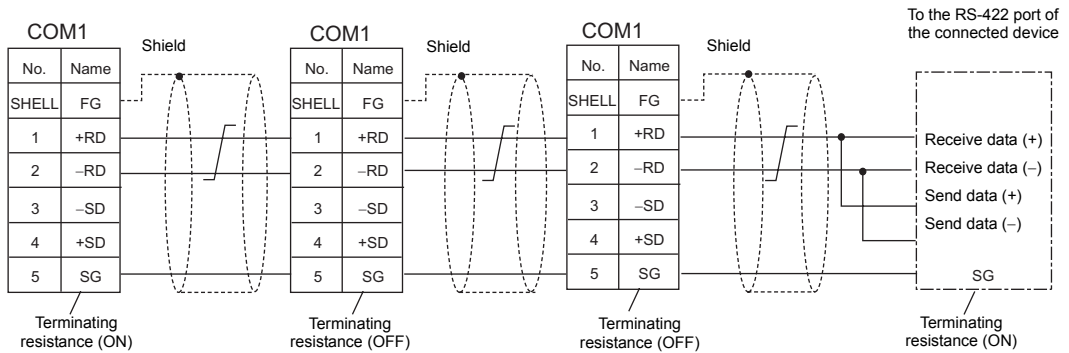

* Use shielded twist-pair cables.

* Jumpers may not be necessary, depending on the connected device.

When Connected at COM3:

- DIPSW No. 8: Terminating resistance setting

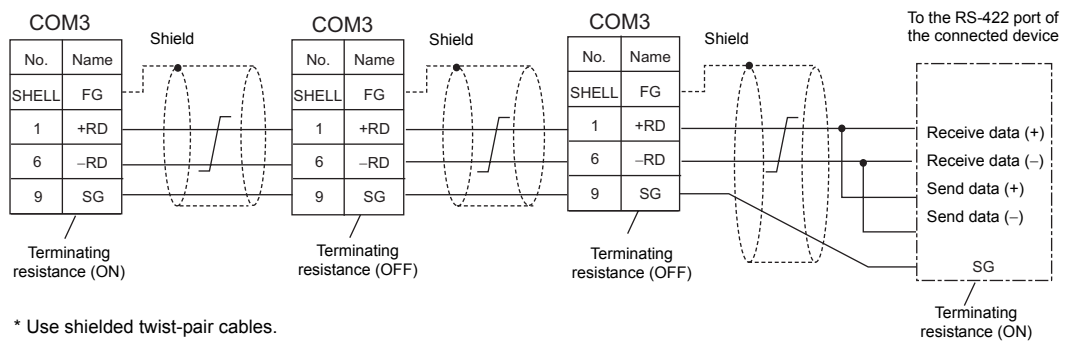

* Use shielded twist-pair cables.

* Jumpers may not be necessary, depending on the connected device.

Setting on the Editor

The settings for Multi-link are covered below. The differences with respect to a 1 : 1 connection and the points where care is required are explained here.

PLC selection

Select the PLC corresponding to the multi-link connection in the [Communication Setting] tab window ([System Setting] → [Device Connection Setting] → [PLC1]).

Communication Setting

Connection Mode	Multi-link
-----------------	------------

Multi-link

Click the [Setting] button next to [Connection Mode: Multi-link] to display the [Multi-link] dialog, then make the necessary settings in this dialog.

Local Port No.*1	1 to 32 Specify a port number of the TS series. Note that if the port number specified is the same as that already set for another TS unit, the system will not operate correctly.
Send Delay Time*1	0 to 255 msec (Default setting: 20 msec) Specify a delay time that elapses before TS sends the next command after receiving data from the PLC.
Total*1	2 to 32 Set the maximum number of TS series units to be connected in "Multi-link" connection. *2
Retry Cycle*1	1 to 100 (× 10) When the TS series has a problem, it is temporarily removed from the communication targets, and the master sends an inquiry for restoration every number of cycles specified for [Retry Cycle]. This setting does not affect the communication speed if no problem is occurring; however, if there is any problem, it does affect the communication speed. When the setting value is small: It will not take a long time before restoration. When the setting value is large: It will take a longer time before restoration.

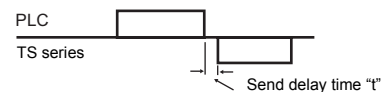

<input type="checkbox"/> Set Local Port No. in Main Menu	<ul style="list-style-type: none"> • When unchecked: Set the local port number for screen data. • When checked: Set the local port number on TS series (see "TS Series Setting").
--	---

- *1 For [Send Delay Time], [Total] and [Retry Cycle], the same values must be set on all the TS series that are connected in the same communication line.
 *2 When connecting three units with the local port numbers 1, 2 and 10, specify "10" for [Total].

TS Series Setting

Local port number setting (Main Menu)

When [Set Local Port No. in Main Menu] is checked in the [Communication Setting] tab window for Multi-link, the local port number must be set on the Main Menu screen of the TS series.

1. Transfer screen data.
2. Bring up the Main Menu screen on TS series.
3. Hold down the [Editor: USB] switch at the lower left corner of the screen for 3 seconds or longer. The Extended Function Setting screen is displayed.

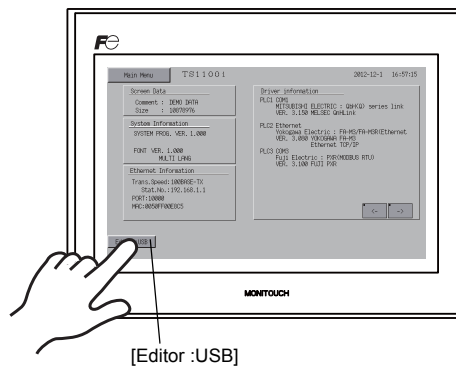

4. Display the [Local No.] field using the [Up] or [Down] switch. (See (1) in the figure below.)

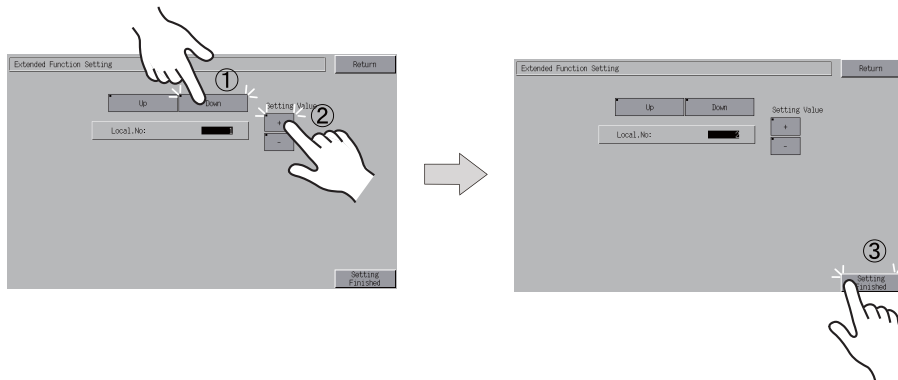

5. Set the local port number using the [↑] and [↓] switches. (See (2) in the figure above.)
6. Press the [Setting Finished] switch. The Main Menu screen is displayed again. (See (3) in the figure above.)

The local port number specified here is commonly used for V-Link, Modbus slave and Multi-link communications. Set a number within the range of these communications.

- V-Link: 1 to 254
- Modbus slave: 1 to 31
- Multi-link: 1 to 32

MEMO

Please use this page freely.

Appendix 5 Ladder Transfer Function

Overview

Through a USB- or Ethernet-linked TS unit, writing or monitoring PLC ladder programs is possible.

- * For applicable PLC models, see “Available PLC Models” on page App5-2. Ladder transfer is enabled, provided that these settings are made in the [Device Connection Setting] dialog on V-SFT: [PLC1] as the connection target PLC and [1 : 1] for [Connection Mode].

- Ladder transfer via USB

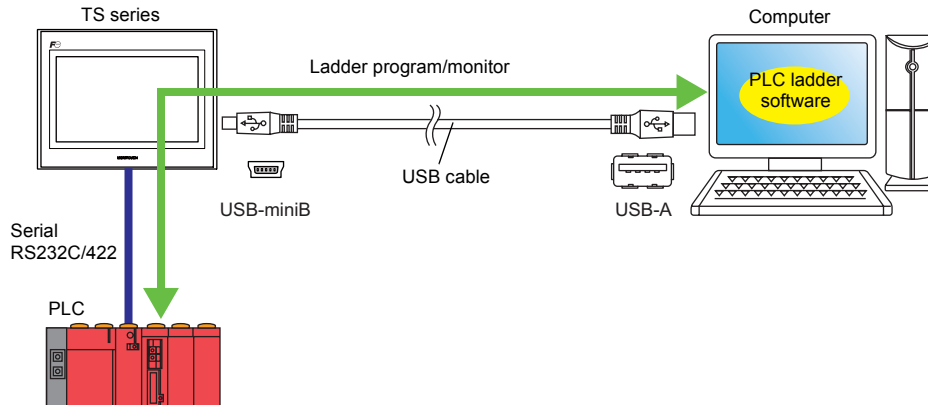

- Ladder transfer via Ethernet

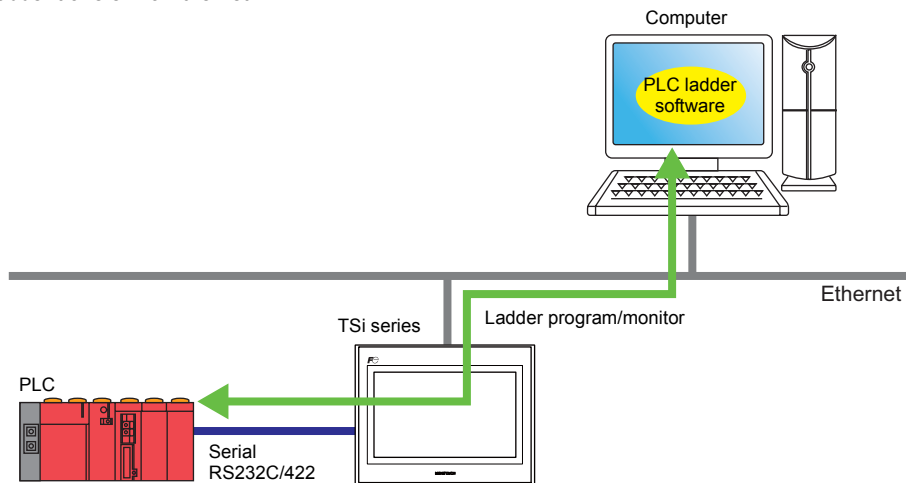

Operating Environment

Applicable TS Models

Model	Port
TS1100i TS1070i	Built-in LAN or USB-miniB
TS1100 TS1070	USB-miniB

Applicable OS for Computer

Be sure to use Hako Electronics' ladder tool software "LadderComOp" version 2.

* If the software version 1 is installed on the computer, update the software.

LadderComOp Version	Applicable OS	Remarks
Ver. 2	Microsoft Windows 2000 / XP / Vista / 7	

Available PLC Models

Manufacturer	Model Setting in V-SFT*	Remarks
MITSUBISHI ELECTRIC	QnH (Q) series CPU Q00J/Q00/Q01 series CPU QnH (Q) series CPU (multi CPU) QnU series CPU FX2N/1N series CPU FX1S series CPU FX3U/3UC/3G series CPU	Ladder transfer available with only PLCs (CPUs) connected to TS
OMRON	SYSMAC CS1/CJ1	
Panasonic	FP Series "RS232C/422"	
Yokogawa Electric	FA-M3 FA-M3R	
Fuji Electric	MICREX-SX SPH/SPB CPU	

* Ladder transfer via USB or Ethernet is enabled, provided that these settings are made in the [Device Connection Setting] dialog on V-SFT: [PLC1] as the connection target PLC and [1 : 1] for [Connection Mode].

Settings

V-SFT Setting

- [Device Connection Setting] → App5-3

LadderComOp Setting

- Installation → App5-6
- [Ladder Transfer Setting] → App5-12



LadderComOp

This is an application required for ladder transfer via USB or Ethernet.

"LadderComOp.exe" can be installed at the time of installing (updating) V-SFT-5, or can be downloaded from the Hakko Electronics website at <http://www.hakko-elec.co.jp/jp/download/05other/index.php>.

PLC Programming Software Setting

- COM port setting → App5-15

V-SFT Setting

This section explains the settings for ladder transfer using the QnH (Q) series (MITSUBISHI ELECTRIC) as an example.

[Device Connection Setting]

1. Click [System Setting] → [Device Connection Setting]. The [Device Connection Setting] dialog is displayed.

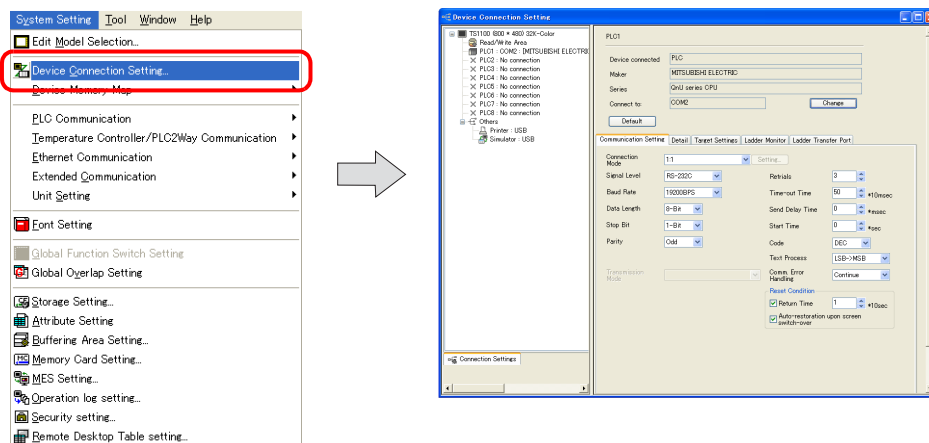

- Open the [Ladder Transfer Port] tab window.
Check Use Ladder Tool]. Select an option for [Connection].

- For ladder transfer via USB: [Connection: USB B]

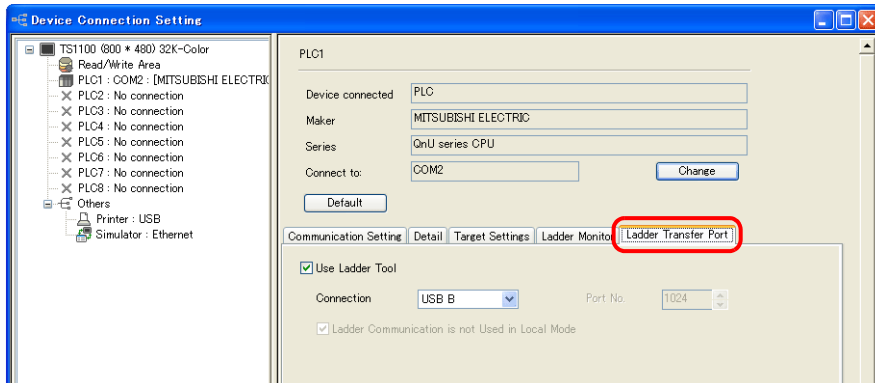

- For ladder transfer via Ethernet: [Connection: Built-in LAN], [Port No. 1024] (as default)

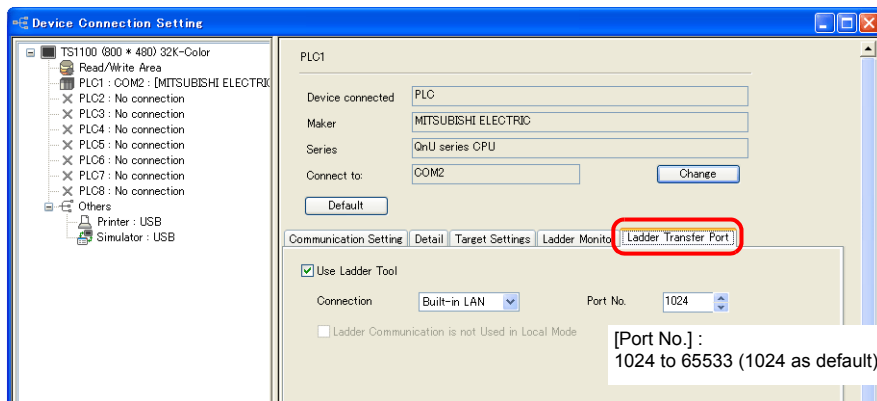

[Port No.]

The [Port No.] selected above will be used as the receiving port on the TSi series during ladder transfer between the TSi unit and a computer. Also, the port of [Port No.] plus 1 will be used as the sending port on the TSi series for transmission to a computer. Therefore, check that the same port number is not already assigned to a different function in screen data.

Example: [Port No.] set to "1024"

Receiving port on the TSi series: 1024

Sending port on the TSi series: 1025

- * The port number assigned here is used for the LadderComOp setting. See the sections below for more information.

- LadderComOp version 2 setting → App5-13
- PLC Programming Software Setting → App5-13

- The procedure for setting is complete. Transfer the screen data to the TS series.



Notes on ladder transfer via USB

Observe the following when transferring screen data via a USB cable.

- Switch to the Main Menu screen on the TS series.
(Ladder communication is enabled on the RUN screen only.)
- Place LadderComOp version 2 offline.
(For more information on this setting, see "[Ladder Transfer Setting]" (App5-12).

LadderComOp Setting

Ladder transfer via USB/Ethernet is available, provided that the dedicated tool, LadderComOp, is installed on the computer. If LadderComOp is already installed, go to "[Ladder Transfer Setting]" on App5-12.



There are LadderComOp version 1 and version 2. Be sure to install version 2.
Obtain LadderComOp version 2 in either of the two ways below:

- A CD of V-SFT version 5.4.28.0 or later, or V-SFT updated version offered at Hakko Electronics website
Downloading from: <http://www.hakko-elec.co.jp/download/09vsft5/index.php>
- "LadderComOp.exe" at Hakko Electronics website
Downloading from: <http://www.hakko-elec.co.jp/download/05other/index.php>

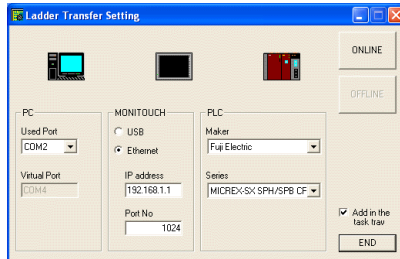

- * How to check the version of LadderComOp
Click the mark at the top left corner of the [Ladder Transfer Setting] dialog and select [About LadderComOp] to see the software version.

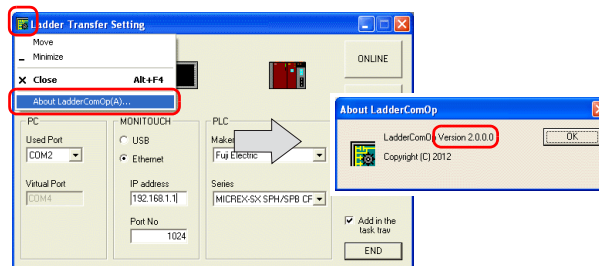

Installation

Perform the steps below to install LadderComOp.

- New installation of version 2 → App5-6
- Update from version 1 to version 2 → App5-9

New installation of version 2

This section explains how to install LadderComOp version 2 on Windows XP as an example. If you download and install "LadderComOp.exe" from the website, start from step 2.



Obtain LadderComOp version 2 in either of the two ways below:

- A CD of V-SFT version 5.4.28.0 or later, or V-SFT updated version offered at Hakko Electronics website
 Downloading from: <http://www.hakko-elec.co.jp/jp/download/09vsft5/index.php>
- "LadderComOp.exe" at Hakko Electronics website
 Downloading from: <http://www.hakko-elec.co.jp/jp/download/05other/index.php>

1. When installing or updating V-SFT-5 is finished, the following dialog is displayed.
Click [Yes].

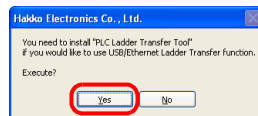

2. Click [Next].

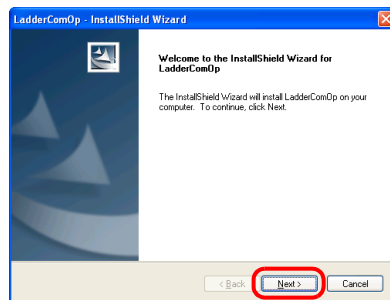

3. Select the destination for installing the software and click [Next].

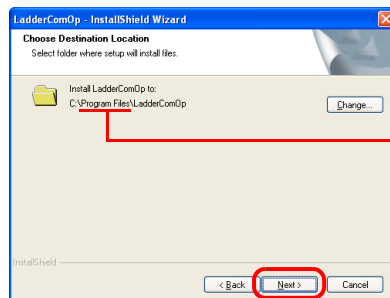

Destination for installation (default):
 Windows 2000 / XP: Program Files
 Windows Vista / 7 / 8: MONITOUCH

4. Click [Install].

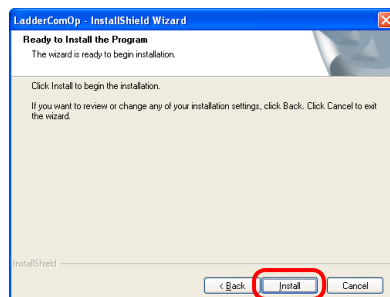

5. Installation starts.

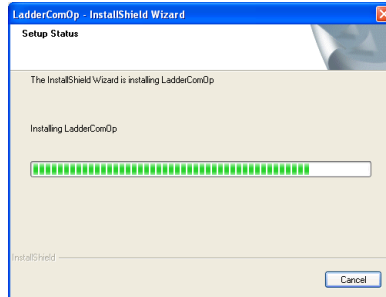

The window below appears during installation.

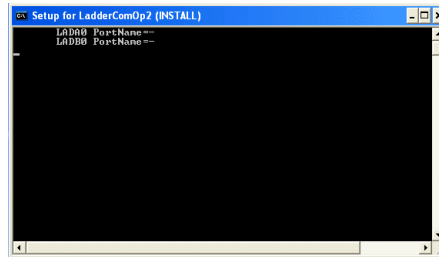

6. The dialog indicating completion of installation is displayed. Click [Finish].

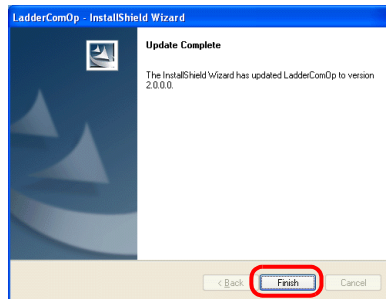

7. The message "Found New Hardware" is displayed and then the installation wizard is displayed on the computer. Check [No, not this time] and click [Next].

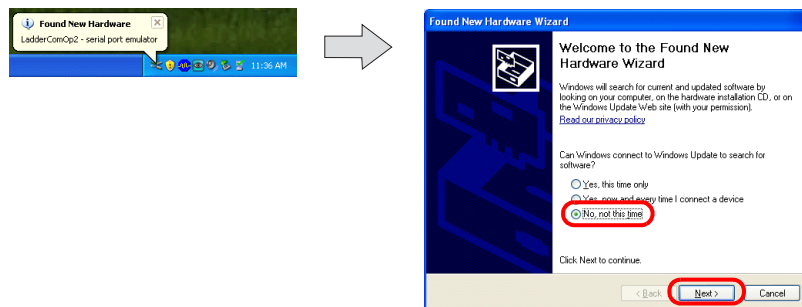

8. When the dialog below is displayed, check [Install the software automatically (Recommended)] and click [Next].

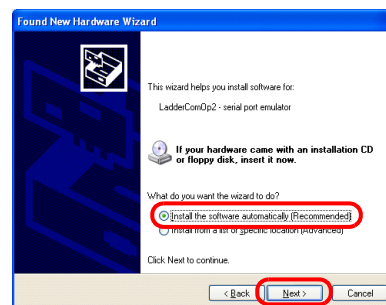

9. Installation starts.

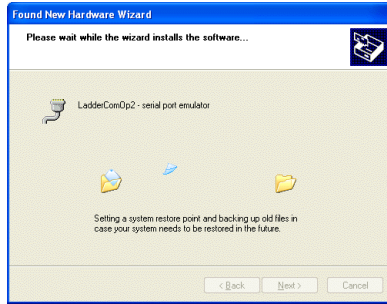

10. The dialog indicating completion of installation is displayed. Click [Finish].

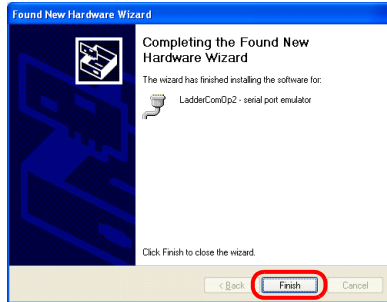

11. Repeat steps 7 through 10 for installation.

12. Open the [Device Manager] of the computer.

When installation is successful, "LadderComOp2" appears in the [Device Manager] window.

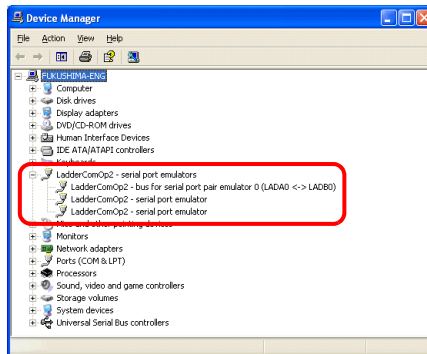

 If installation fails, a yellow mark "!" is displayed at " LadderComOp2" in the [Device Manager] window. In such a case, uninstall and reinstall LadderComOp.

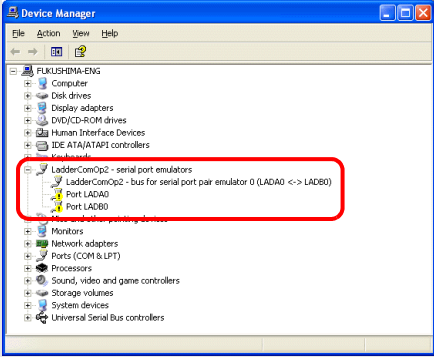

The procedure for installing LadderComOp version 2 is complete.

Update from version 1 to version 2

This section explains how to update LadderComOp version 1 to version 2 on Windows XP as an example.



Obtain LadderComOp version 2 in either of the two ways below:

- A CD of V-SFT version 5.4.28.0 or later, or V-SFT updated version offered at Hakko Electronics website
Downloading from: <http://www.hakko-elec.co.jp/jp/download/09vsft5/index.php>
- "LadderComOp.exe" at Hakko Electronics website
Downloading from: <http://www.hakko-elec.co.jp/jp/download/05other/index.php>



Following the uninstallation of LadderComOp version 1, the installation of version 2 starts.

Be sure to reboot the computer after installing LadderComOp version 2.

Also, settings for LadderComOp need to be set again.

For more information on this setting, see [Ladder Transfer Setting] on page App5-12.

1. When V-SFT-5 is installed (updated)* or when "LadderComOp.exe" downloaded from the website is executed, the following dialog is displayed.
Click [Yes].

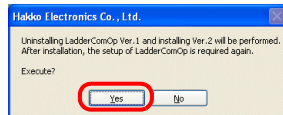

* V-SFT-5 version 5.4.28.0 or later supported

2. Click [Next].

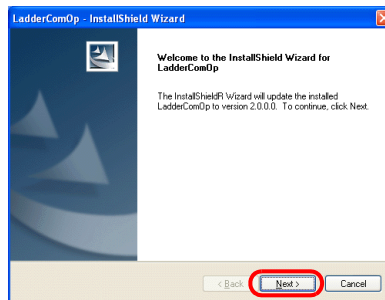

3. A LadderComOp update starts.

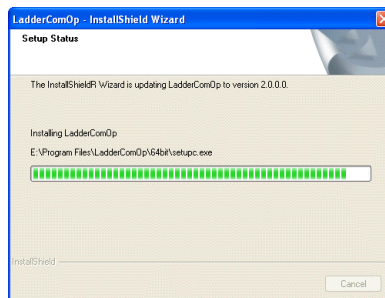

The window below appears during installation.

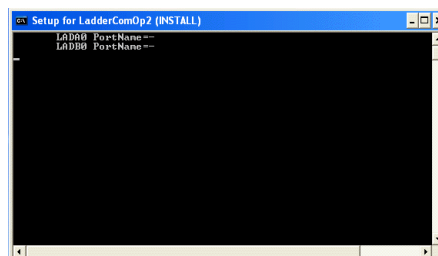

- Click [Finish].

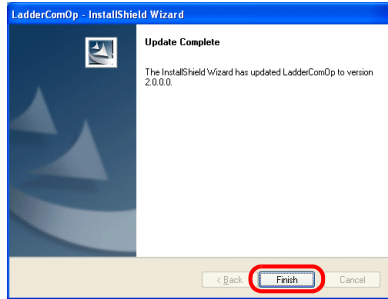



The dialog for rebooting the computer is displayed. Do not reboot the computer yet. Go to step 5.

- The message "Found New Hardware" is displayed and then the installation wizard is displayed on the computer. Check [No, not this time] and click [Next].

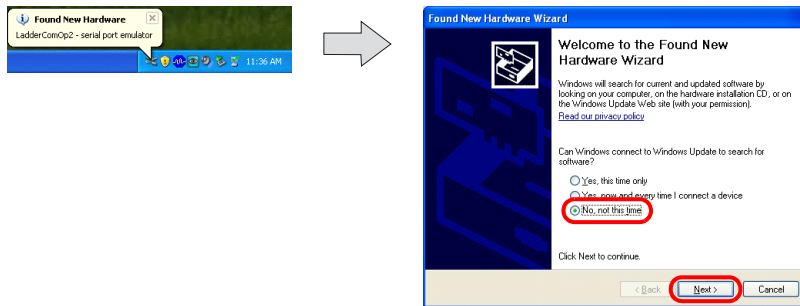

- When the dialog below is displayed, check [Install the software automatically (Recommended)] and click [Next].

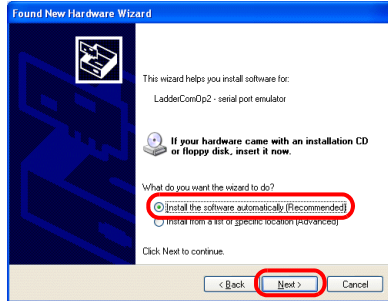

- Installation starts.

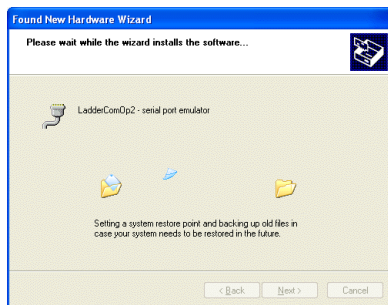

8. The dialog indicating completion of installation is displayed. Click [Finish].

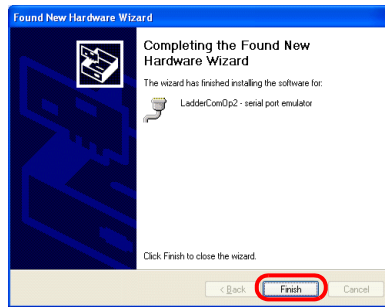

9. Repeat steps 5 through 8 for installation.

10. The dialog indicating completion of the update is displayed. Click [Finish]. Reboot the computer.

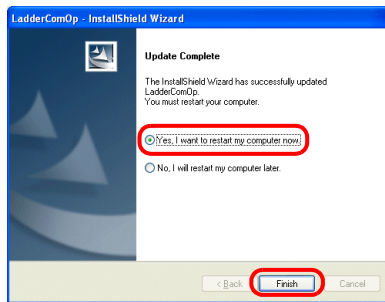

Be sure to reboot the computer. Using the computer without rebooting may cause a malfunction.

11. Open the [Device Manager] of the computer.
When installation is successful, "LadderComOp2" appears in the [Device Manager] window.

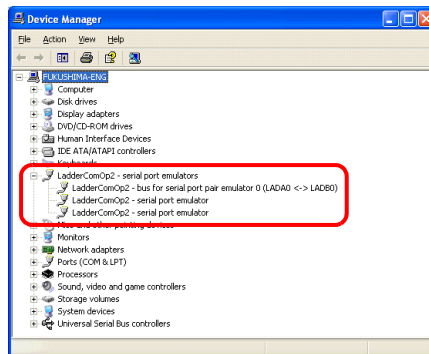

If installation fails, a yellow mark "!" is displayed at "LadderComOp2" in the [Device Manager] window.
In such a case, uninstall and reinstall LadderComOp.

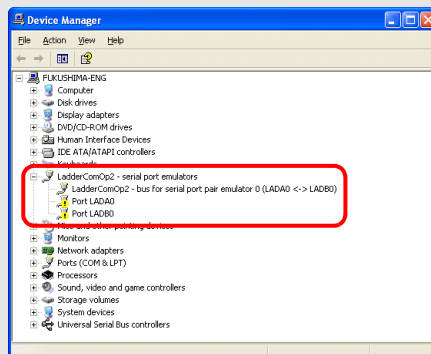

The procedure for updating from version 1 to version 2 is complete.

[Ladder Transfer Setting]

Start

1. From the [Start] menu of the computer, click [Programs] → [V-SFTV5] → [LadderComOp] → [Ladder Transfer Setting].

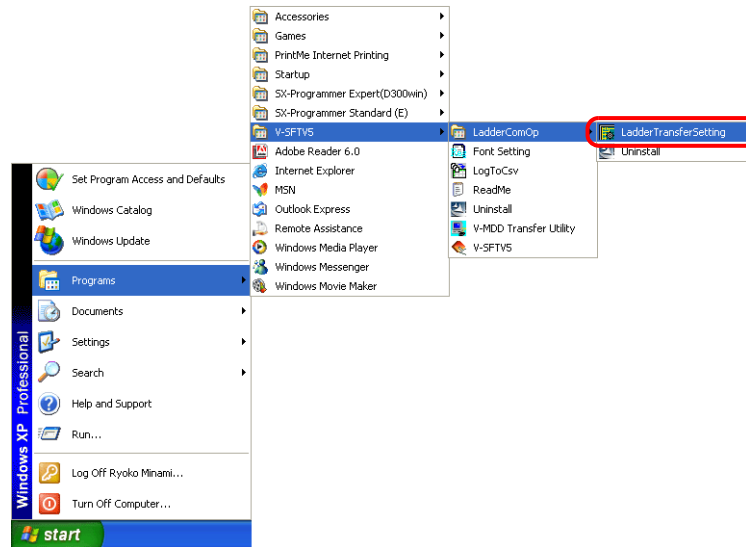

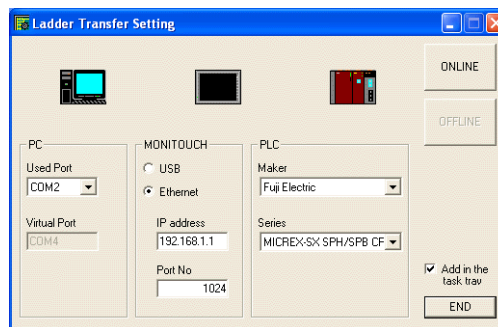

2. The [Ladder Transfer Setting] dialog is displayed.

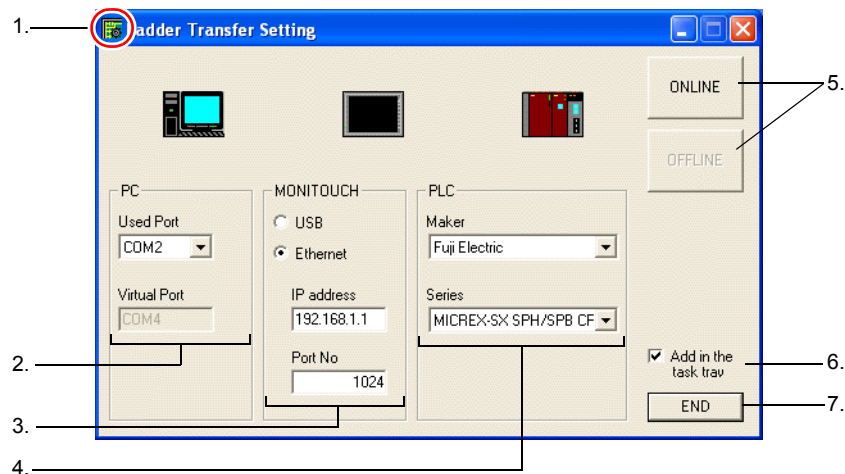

LadderComOp version 2 setting



1. Icon	Clicking this icon and selecting [About LadderComOp] opens the dialog that displays the version of LadderComOp.
2. PC	<p>Two COM ports on the computer are used.</p> <p>Used Port Select a COM port for ladder transfer from the list. Range: COM1 to COM256 (COM ports already assigned to other purposes on the computer are not listed.) The COM port number selected in this field is to be set in the PLC programming software.</p> <p>* The range of COM port numbers is limited, depending on the PLC programming software. For more information, refer to the PLC manual issued by the manufacturer.</p> <p>Example: COM1 to COM15 for FPWIN GR (Panasonic) (COM1 to COM5 for version 2.2 or lower)</p> <p>Virtual Port A COM port number not in use is to be automatically assigned.</p>
3. TS series	<p>Select a method for connecting the computer and the TS series.</p> <p>USB No particular setting necessary</p> <p>Ethernet</p> <ul style="list-style-type: none"> • IP address Specify the local IP address of the TSi series (with built-in LAN port). • Port No. Set the port number of the TSi series. Set the same port number as in [Ladder Transfer Port] under [PLC1] ([System Setting] → [Device Connection Setting] → [PLC1]) Range: 1024 to 65533 (1024 as default)
4. PLC	Select the maker and the model of the PLC.
5. ONLINE and OFFLINE	<p>Each button places ladder transfer online or offline between the computer and the TS series.</p> <p>ONLINE This button establishes connection between the computer and the TS series to activate the ladder transfer mode.</p> <p>OFFLINE This button disconnects the computer from the TS series. This button causes a forced disconnection even during ladder transfer.</p>

6. <input type="checkbox"/> Add in the task tray	<p>Select whether LadderComOp resides on the task tray.</p> <ul style="list-style-type: none">• Checked While ladder transfer is online or the [Ladder Transfer Setting] dialog is minimized, the icon of the dialog resides on the task tray. While ladder transfer is online, the message “Transferring” appears in the tooltip displayed at the task tray.  <p>Right-clicking the icon on the task tray opens the menu.</p>  <p>Return This option opens the [Ladder Transfer Setting] dialog.</p> <p>Quit This option disconnects the computer from the TS series. This option causes a forced disconnection even during ladder transfer.</p> <ul style="list-style-type: none">• Unchecked (default) The [Ladder Transfer Setting] dialog is left open. The dialog can be minimized to be placed on the taskbar.
7. END	This button disconnects the computer from the TS series and closes the [Ladder Transfer Setting] dialog.

PLC Programming Software Setting

Set the same COM port set in the [Ladder Transfer Setting] dialog in LadderComOp, to the COM port in the dialog shown below in the programming software for the PLC.

Example: COM port No. 9 in the [Ladder Transfer Setting] dialog

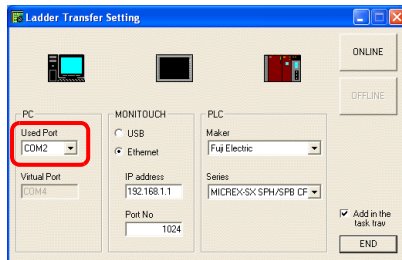

MITSUBISHI ELECTRIC: GX Developer/Gx Works2

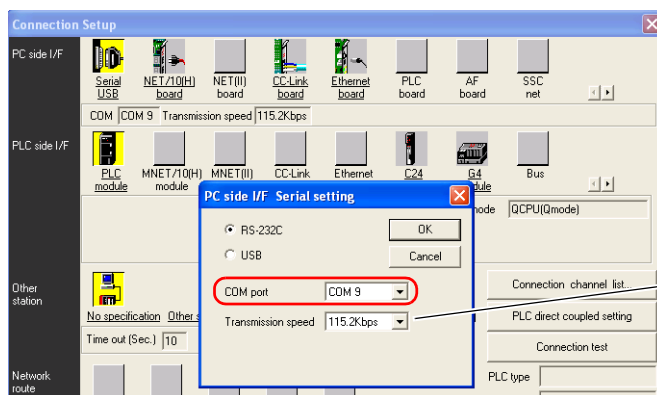

In this field, select the same value as the baud rate between the TS unit and the PLC.

OMRON CX-Programmer

Be sure to select "SYSMAC WAY" for [Network Type].
[Network Settings] dialog → [Driver] → [Port Name]
For [Baud Rate], specify the same value between the TS unit and the PLC.

Panasonic "FPWIN GR"

[Communication Settings] dialog → [Port No.]
For [Baud Rate], specify the same value between the TS unit and the PLC.

Yokogawa Electric "Wide Field2"

[Environmental Settings] dialog → [Communication Settings] → [COM Port No.]

Fuji Electric "SX-Programmer Expert (D300win)"

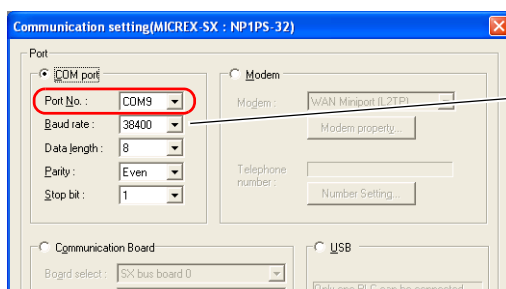

In this field, select the same value as the baud rate between the TS unit and the PLC.

Notes

- Ladder transfer via USB
Observe the following when transferring screen data via a USB cable.
 - Switch to the Main Menu screen on the TS series.
(Ladder communication is enabled on the RUN screen only.)
 - Place LadderComOp version 2 offline.
(For more information on this setting, see “[Ladder Transfer Setting]” (page App5-12).)
- Ladder transfer via Ethernet
For screen data transfer or ladder transfer via Ethernet, either the RUN screen or the Main Menu screen can be displayed on the TS series.

Connection Compatibility List

April, 2013

Manufacturer	Models	1 : 1	1 : n Multi-drop	n : 1 Multi-link2	Multi-link2 Ethernet	1 : n Multi-link2 Ethernet	n : 1 Multi-link
Allen-Bradley	PLC-5	○	○	○	○	○	○
	PLC-5 (Ethernet)	○	○				
	Control Logix / Compact Logix	○					
	Control Logix (Ethernet)	○	○				
	SLC500	○	○	○			
	SLC500 (Ethernet TCP/IP)	○	○				
	NET-ENI (SLC500 Ethernet TCP/IP)	○	○				
	NET-ENI (MicroLogix Ethernet TCP/IP)	○	○				
	Micro Logix	○	○	○			
Micro Logix (Ethernet TCP/IP)	○	○					
Automationdirect	Direct LOGIC (K-Sequence)	○		○			
	Direct LOGIC (Ethernet UDP/IP)	○	○				
	Direct LOGIC (MODBUS RTU)	○	○	○			
Baumuller	BMx-x-PLC	○		○			
BECKHOFF	ADS protocol (Ethernet)	○	○				
CHINO	LT400 Series (MODBUS RTU)	○	○	○	○	○	
	DP1000	○	○	○	○		
	DB100B (MODBUS RTU)	○	○	○	○		
	KR2000 (MODBUS RTU)	○	○	○	○		
	LT230 (MODBUS RTU)	○	○	○	○		
	LT300 (MODBUS RTU)	○	○	○	○		
CIMON	BP series	○		○	○		
	CP series	○		○	○		
DELTA	DVP series	○	○	○			
DELTA TAU DATA SYSTEMS	PMAC	○		○	○		
	PMAC(Ethernet TCP/IP)	○	○				
EATON Cutler-Hammer	ELC	○	○	○			
EMERSON	EC10/20/20H (MODBUS RTU)	○	○	○	○		
FANUC	Power Mate	○		○			
Fatek Automation	FACON FB Series	○	○	○			
FUFENG	APC Series Controller	○	○	○	○	○	
Fuji Electric	MICREX-F series	○	○	○			○
	MICREX-F series V4-compatible	○	○	○			
	SPB (N mode) & FLEX-PC series	○	○	○			
	SPB (N mode) and FLEX-PC CPU	○		○			
	MICREX-SX SPH/SPB series	○		○			
	MICREX-SX SPH/SPB CPU	○		○			
	MICREX-SX (Ethernet)	○	○				
	PYX (MODBUS RTU)	○	○	○			
	PXR (MODBUS RTU)	○	○	○			
	PXG (MODBUS RTU)	○	○	○			
	PXH (MODBUS RTU)	○	○	○			
	PUM (MODBUS RTU)	○	○	○			
	F-MPC04P (loader)	○	○	○			
	F-MPC series / FePSU	○	○	○			
	FVR-E11S	○	○	○	○	○	
	FVR-E11S (MODBUS RTU)	○	○	○			
	FVR-C11S (MODBUS RTU)	○	○	○			
	FRENIC5000 G11S/P11S	○	○	○	○	○	
	FRENIC5000 G11S/P11S (MODBUS RTU)	○	○	○			
	FRENIC5000 VG7S (MODBUS RTU)	○	○	○			
	FRENIC-HVAC/AQUA (MODBUS RTU)	○	○	○	○	○	
	FRENIC-Mini (MODBUS RTU)	○	○	○			
	FRENIC-Eco (MODBUS RTU)	○	○	○			
	FRENIC-Multi (MODBUS RTU)	○	○	○			
	FRENIC-MEGA (MODBUS RTU)	○	○	○			
	FRENIC-MEGA SERVO(MODBUS RTU)	○	○	○	○	○	
	HFR-C9K	○	○	○			
	HFR-C11K	○	○	○			
	PPMC (MODBUS RTU)	○	○	○			

Manufacturer	Models	1 : 1	1 : n Multi-drop	n : 1 Multi-link2	Multi-link2 Ethernet	1 : n Multi-link2 Ethernet	n : 1 Multi-link
Fuji Electric	FALDIC- α series	○	○	○			
	FALDIC-W series	○	○	○	○	○	
	PH series	○	○	○	○	○	
	PHR (MODBUS RTU)	○	○	○			
	WA5000	○	○	○			
	APR-N (MODBUS RTU)	○	○	○			
	ALPHA5 (MODBUS RTU)	○	○	○			
	ALPHA5 Smart (MODBUS RTU)	○	○	○	○	○	
	WE1MA (Ver. A)(MODBUS RTU)	○	○	○	○	○	
	WE1MA (Ver. B)(MODBUS RTU)	○	○	○	○	○	
WSZ series	○	○	○	○	○		
GE Fanuc	90 series	○	○	○	○		
	90 series (SNP-X)	○		○			
	90 series (SNP)	○	○	○	○	○	
	90 series (Ethernet TCP/IP)	○	○				
	RX3i (Ethernet TCP/IP)	○	○				
Hitachi	HIDIC-S10/2 α , S10mini	○		○			
	HIDIC-S10/2 α , S10mini (Ethernet)	○	○				
	HIDIC-S10/4 α	○		○	○		
	HIDIC-S10V	○		○			
	HIDIC-S10V (Ethernet)	○	○				
Hitachi Industrial Equipment Systems	HIDIC-H	○	○	○			○
	HIDIC-H (Ethernet)	○	○				
	HIDIC-EHV	○	○	○			○
	HIDIC-EHV (Ethernet)	○	○				
	SJ300 series	○	○	○	○		
	SJ700 series	○	○	○	○		
IAI	X-SEL controller	○	○	○			
	ROBO CYLINDER (RCP2/ERC)	○	○	○	○	○	
	ROBO CYLINDER (RCS/E-CON)	○	○	○	○	○	
	PCON/ACON/SCON (MODBUS RTU)	○	○				
IDEC	MICRO 3	○	○	○			
	MICRO Smart	○	○	○			
	MICRO Smart pentra	○	○	○	○		
Jetter	JetControl Series2/3 (Ethernet UDP/IP)	○	○				
JTEKT	TOYOPUC	○	○	○			○
	TOYOPUC (Ethernet)	○	○				
	TOYOPUC (Ethernet PC10 mode)	○	○				
KEYENCE	KZ-A500 CPU	○		○			
	KV10/24 CPU	○		○			
	KV-700	○		○			
	KV-700 (Ethernet TCP/IP)	○	○				
	KV-1000	○		○			
	KV-1000 (Ethernet TCP/IP)	○	○				
	KV-3000/5000	○		○			
	KV-3000/5000 (Ethernet TCP/IP)	○	○				
KOYO ELECTRONICS	SU/SG	○	○	○	○		
	SR-T (K protocol)	○		○	○		
	SU/SG (K-Sequence)	○		○			
	SU/SG (Modbus RTU)	○	○	○			
LS	MASTER-KxxxS	○		○			
	MASTER-KxxxS CNET	○	○	○			
	GLOFA CNET	○	○	○	○		○
	GLOFA GM7 CNET	○	○	○	○	○	
	GLOFA GM series CPU	○		○	○		
	XGT/XGK series CNET	○	○	○			
	XGT/XGK series CPU	○		○			
	XGT/XGK series (Ethernet)	○	○				
	XGT/XGI series CNET	○	○	○	○	○	
	XGT/XGI series CPU	○		○	○		
XGT/XGI series (Ethernet)	○	○					

Manufacturer	Models	1 : 1	1 : n Multi-drop	n : 1 Multi-link2	Multi-link2 Ethernet	1 : n Multi-link2 Ethernet	n : 1 Multi-link
MITSUBISHI ELECTRIC	A series link	○	○	○			○
	QnA series link	○	○	○			
	QnA series (Ethernet)	○	○				
	QnH (Q) series link	○	○	○			
	QnH (Q) series CPU	○		○			
	QnU series CPU	○		○			
	Q00J/00/01CPU	○		○			
	QnH (Q) series (Ethernet)	○	○				
	QnH (Q) series link (multi CPU)	○	○	○			
	QnH (Q) series (multi CPU) (Ethernet)	○	○				
	QnH (Q) series CPU (multi CPU)	○		○			
	QnH (Q) series (Ethernet ASCII)	○	○				
	QnH (Q) series (multi CPU) (Ethernet ASCII)	○	○				
	QnU series (built-in Ethernet)	○	○				
	L series link	○	○	○	○		
	L series (built-in Ethernet)	○	○				
	FX2N/1N series CPU	○		○			
	FX1S series CPU	○		○			
	FX series link (A protocol)	○	○	○			○
	FX-3U/3UC/3G series CPU	○		○			
	FX-3U series (Ethernet)	○	○				
	FX3U/3UC/3UG series link (A protocol)	○	○	○			○
	Q170MCP (multi CPU)	○		○	○		
	Q170 series (multi CPU) (Ethernet)	○	○				
	FR-*500	○	○	○			
	FR-V500	○	○	○			
	MR-J2S-*A	○	○	○	○		
MR-J3-*A	○	○	○	○			
MR-J3-*T	○	○	○	○			
FR-E700	○	○	○	○			
MODICON	Modbus RTU	○		○	○		
MOELLER	PS4	○		○	○		
M-SYSTEM	R1M series (MODBUS RTU)	○	○	○	○	○	
OMRON	SYSMAC C	○	○	○			○
	SYSMAC CV	○	○	○			○
	SYSMAC CS1/CJ1	○	○	○			
	SYSMAC CS1/CJ1 DNA	○	○				
	SYSMAC CS1/CJ1 (Ethernet)	○	○				
	SYSMAC CS1/CJ1 (Ethernet Auto)	○	○				
	SYSMAC CS1/CJ1 DNA (Ethernet)	○	○				
	E5AK	○	○	○	○		
	E5AK-T	○	○	○	○	○	
	E5AN/E5EN/E5CN/E5GN	○	○	○			
	E5AR/E5ER	○	○	○			
	E5CK	○	○	○	○		
	E5CK-T	○	○	○	○	○	
	E5CN-HT	○	○	○	○	○	
	E5EK	○	○	○	○		
	E5ZD	○	○	○	○		
	E5ZE	○	○	○	○		
	E5ZN	○	○	○	○		
	V600/620/680	○	○	○			
	KM20	○	○	○	○		
	KM100	○	○	○	○		
Oriental Motor	High-efficiency AR series (MODBUS RTU)	○	○	○	○	○	
	CRK series (MODBUS RTU)	○	○	○	○	○	
Panasonic	FP series	○	○	○			○
	FP series (Ethernet TCP/IP)	○	○				
	FP series (Ethernet UDP/IP)	○	○				
	FP-X (Ethernet TCP/IP)	○	○				
	LP-400	○		○			
	KW Series	○	○	○	○	○	
	MINAS A4 series	○	○	○	○	○	

Manufacturer	Models	1 : 1	1 : n Multi-drop	n : 1 Multi-link2	Multi-link2 Ethernet	1 : n Multi-link2 Ethernet	n : 1 Multi-link
RKC	SR-Mini (MODBUS RTU)	○	○	○			
	CB100/CB400/CB500/CB700/CB900 (MODBUS RTU)	○	○	○			
	SR-Mini (Standard Protocol)	○	○	○			
	REX-F400/F700/F900(Standard Protocol)	○	○	○	○		
	SRV (MODBUS RTU)	○	○	○			
	MA900/MA901 (MODBUS RTU)	○	○	○			
	SRZ (MODBUS RTU)	○	○	○			
	FB100/FB400/FB900 (MODBUS RTU)	○	○	○	○	○	
RS Automation	NX7/NX Plus Series (70P/700P/CCU+)	○	○	○	○	○	○
	N7/NX Series (70/700/750/CCU)	○	○	○			○
	NX700 Series (Ethernet)	○	○				
	X8 Series	○	○	○	○	○	○
	X8 Series (Ethernet)	○	○				
SAIA	PCD	○	○	○			
	PCD S-BUS (Ethernet)	○	○				
SAMSUNG	N_plus	○	○	○	○	○	○
	SECNET	○	○	○			○
SANMEI	Cuty Axis	○	○	○	○	○	
SanRex	DC AUTO (HKD type)	○	○	○			
SHARP	JW series	○	○	○			○
	JW100/70H COM port	○	○	○			○
	JW20 COM port	○	○	○			○
	JW series (Ethernet)	○	○				
	JW300 series	○	○	○	○		○
	JW311/312/321/322 series (Ethernet)	○	○				
	JW331/332/341/342/352/362 series (Ethernet)	○	○				
SHIMADEN	SHIMADEN standard protocol	○	○	○	○		
SHINKO TECHNOS	C Series	○	○	○	○	○	
	FC Series	○	○	○	○	○	
	GC Series	○	○	○	○	○	
	DCL-33A	○	○	○			
	JCx-300 Series	○	○	○	○	○	
	PC-900	○	○	○	○	○	
	PCD-33A	○	○	○	○	○	
	ACS-13A	○	○	○	○	○	
	ACD/ACR Series	○	○	○	○	○	
	WCL-13A	○	○	○	○	○	
Siemens	S5 PG port	○	○	○	○	○	
	S7	○		○			
	S7-200 PPI	○	○				○
	S7-200 (Ethernet ISOTCP)	○	○				
	S7-300/400 MPI	○	○				
	S7-300/400 (Ethernet ISOTCP)	○	○				
	S7-300/400 (Ethernet TCP/IP PG protocol)	○	○				
	S7-1200 (Ethernet ISOTCP)	○	○				
TI500/505	○	○	○	○	○		
SINFONIA TECHNOLOGY	SELMART	○	○	○			○
TECO	TP-03 (MODBUS RTU)	○	○	○			
Telemecanique	TSX Micro						○
TOHO	TTM-000	○	○	○	○	○	
	TTM-00BT	○	○	○			
	TTM-200	○	○	○			
TOSHIBA	T series / TS series (T compatible)	○	○	○	○		○
	EX series	○	○	○	○		
	VF-S7	○	○	○	○		
	VF-S9	○	○	○	○		
	VF-S11	○	○	○	○		
	VF-A7	○	○	○			
	VF-AS1	○	○	○	○		
	VF-P7	○	○	○	○		
	VF-PS1	○	○	○	○		
	VF-FS1	○	○	○	○		
VF-nC1	○	○	○	○			
TOSHIBA MACHINE	TC200	○	○	○			
	VELCONIC series		○				

Manufacturer	Models	1 : 1	1 : n Multi-drop	n : 1 Multi-link2	Multi-link2 Ethernet	1 : n Multi-link2 Ethernet	n : 1 Multi-link
UNIPULSE	F340A	<input type="radio"/>	<input type="radio"/>	<input type="radio"/>	<input type="radio"/>		
	F371	<input type="radio"/>	<input type="radio"/>	<input type="radio"/>	<input type="radio"/>		
	F800	<input type="radio"/>	<input type="radio"/>	<input type="radio"/>	<input type="radio"/>		
	F720A	<input type="radio"/>	<input type="radio"/>	<input type="radio"/>	<input type="radio"/>		
UNITRONICS	M90/M91/Vision Series (ASCII)	<input type="radio"/>	<input type="radio"/>	<input type="radio"/>			
	Vision Series (ASCII Ethernet TCP/IP)	<input type="radio"/>	<input type="radio"/>				
VIGOR	M series	<input type="radio"/>	<input type="radio"/>	<input type="radio"/>	<input type="radio"/>	<input type="radio"/>	
WAGO	750 series (MODBUS RTU)	<input type="radio"/>	<input type="radio"/>	<input type="radio"/>	<input type="radio"/>	<input type="radio"/>	
	750 series (MODBUS ETHERNET)	<input type="radio"/>	<input type="radio"/>				
YAMAHA	RCX142	<input type="radio"/>		<input type="radio"/>			
Yamatake	MX series	<input type="radio"/>	<input type="radio"/>	<input type="radio"/>	<input type="radio"/>	<input type="radio"/>	
	SDC10	<input type="radio"/>	<input type="radio"/>	<input type="radio"/>	<input type="radio"/>		
	SDC20	<input type="radio"/>	<input type="radio"/>	<input type="radio"/>	<input type="radio"/>		
	SDC21	<input type="radio"/>	<input type="radio"/>	<input type="radio"/>	<input type="radio"/>		
	SDC30/31	<input type="radio"/>	<input type="radio"/>	<input type="radio"/>	<input type="radio"/>		
	SDC35/36	<input type="radio"/>	<input type="radio"/>	<input type="radio"/>			
	SDC40A	<input type="radio"/>	<input type="radio"/>	<input type="radio"/>	<input type="radio"/>		
	SDC40G	<input type="radio"/>	<input type="radio"/>	<input type="radio"/>	<input type="radio"/>		
	DMC10	<input type="radio"/>	<input type="radio"/>	<input type="radio"/>			
	DMC50(COM)	<input type="radio"/>	<input type="radio"/>	<input type="radio"/>			
	AHC2001	<input type="radio"/>	<input type="radio"/>	<input type="radio"/>			
	AHC2001+DCP31/32	<input type="radio"/>	<input type="radio"/>	<input type="radio"/>			
	DCP31/32	<input type="radio"/>	<input type="radio"/>	<input type="radio"/>	<input type="radio"/>		
	NX(CPL)	<input type="radio"/>	<input type="radio"/>	<input type="radio"/>	<input type="radio"/>	<input type="radio"/>	
NX(MODBUS RTU)	<input type="radio"/>	<input type="radio"/>	<input type="radio"/>	<input type="radio"/>	<input type="radio"/>		
NX(MODBUS TCP/IP)	<input type="radio"/>	<input type="radio"/>					
Yaskawa Electric	Memobus	<input type="radio"/>	<input type="radio"/>	<input type="radio"/>			
	CP9200SH/MP900	<input type="radio"/>	<input type="radio"/>	<input type="radio"/>			
	MP2000 series	<input type="radio"/>	<input type="radio"/>	<input type="radio"/>	<input type="radio"/>	<input type="radio"/>	
	MP2300 (MODBUS TCP/IP)	<input type="radio"/>	<input type="radio"/>				
	CP MP expansion memobus (UDP/IP)	<input type="radio"/>	<input type="radio"/>				
	MP2000 series (UDP/IP)	<input type="radio"/>	<input type="radio"/>				
Yokogawa Electric	FA-M3	<input type="radio"/>	<input type="radio"/>	<input type="radio"/>			<input type="radio"/>
	FA-M3R	<input type="radio"/>	<input type="radio"/>	<input type="radio"/>			<input type="radio"/>
	FA-M3/FA-M3R(Ethernet UDP/IP)	<input type="radio"/>	<input type="radio"/>				
	FA-M3/FA-M3R (Ethernet UDP/IP ASCII)	<input type="radio"/>	<input type="radio"/>				
	FA-M3/FA-M3R(Ethernet TCP/IP)	<input type="radio"/>	<input type="radio"/>				
	FA-M3/FA-M3R (Ethernet TCP/IP ASCII)	<input type="radio"/>	<input type="radio"/>				
	UT100	<input type="radio"/>	<input type="radio"/>	<input type="radio"/>			
	UT750	<input type="radio"/>	<input type="radio"/>	<input type="radio"/>			
	UT550	<input type="radio"/>	<input type="radio"/>	<input type="radio"/>			
	UT520	<input type="radio"/>	<input type="radio"/>	<input type="radio"/>			
	UT350	<input type="radio"/>	<input type="radio"/>	<input type="radio"/>			
	UT320	<input type="radio"/>	<input type="radio"/>	<input type="radio"/>			
	UT2400/2800	<input type="radio"/>	<input type="radio"/>	<input type="radio"/>			
UT450	<input type="radio"/>	<input type="radio"/>	<input type="radio"/>				
None	MODBUS RTU	<input type="radio"/>	<input type="radio"/>	<input type="radio"/>	<input type="radio"/>	<input type="radio"/>	
	MODBUS RTU EXT Format	<input type="radio"/>	<input type="radio"/>	<input type="radio"/>	<input type="radio"/>	<input type="radio"/>	
	MODBUS TCP/IP (Ethernet)	<input type="radio"/>	<input type="radio"/>				
	MODBUS TCP/IP (Ethernet) Sub Station	<input type="radio"/>	<input type="radio"/>				
	MODBUS TCP/IP (Ethernet) EXT Format	<input type="radio"/>	<input type="radio"/>				

Slave Communication

Manufacturer	Models	Setting	Remarks
None	Universal serial	<input type="radio"/>	
	V-Link	<input type="radio"/>	Ver. 5.0.1.0
	Modbus slave (RTU)	<input type="radio"/>	Ver. 5.0.1.0
	Modbus slave (TCP/IP)	<input type="radio"/>	Ver. 5.0.2.0

MEMO

Please use this page freely.

Hakko Electronics Co., Ltd.
www.monitouch.com

Sales

**890-1, Kamikashiwano-machi, Hakusan-shi,
Ishikawa, 924-0035 Japan
TEL +81-76-274-2144 FAX +81-76-274-5136**