

MONITOUCH

V9 Replacement Guidance [V4 series]

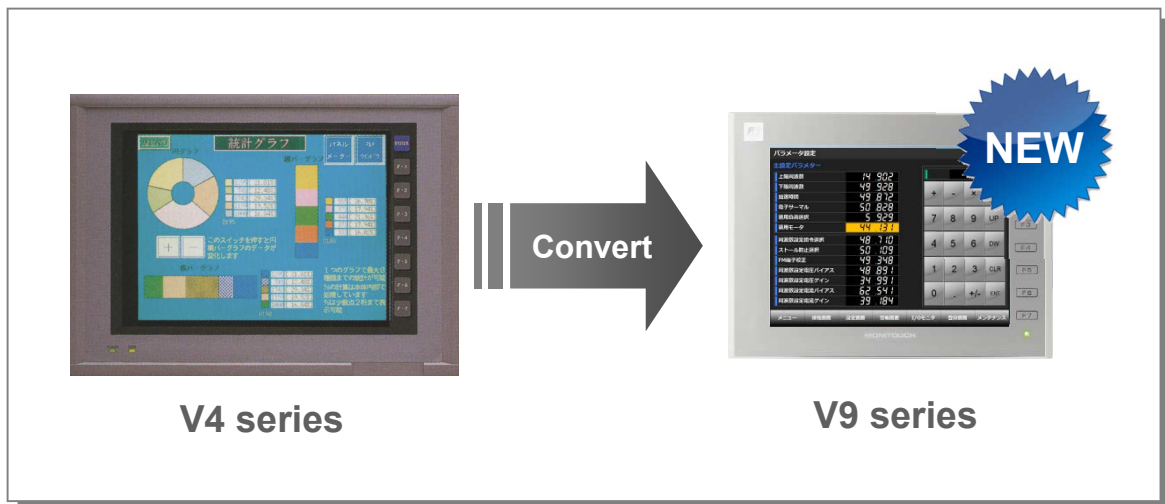

- Recommended models for replacement of V4T series

- Without RGB output

		V4T series	
		V4T0x0x-x	V4T1x0x-x
MONITOUCH	- Front view		
	- Panel cut-out dimensions (mm)		
Display device	TFT color		
Colors	16 colors		8 colors
Resolution	640 × 480 dots		
Touch switch	Matrix		
Comm. I/F	Serial	D-sub 25-pin: RS-232C / RS-422/485 Terminal block: RS-422/485	
	Barcode	D-sub 9-pin (CN7): RS-232C *1	
Storage device	Dedicated memory card *1		
Power supply	85 to 265 VAC		

		Recommended models for replacement	
		V9100iC	
	- Front view		
	- Panel cut-out dimensions (mm) *2		
Display device	TFT color		
Colors	16.77 million colors *3		
Resolution	640 × 480 dots		
Touch switch	Analog *4		
Comm. I/F	D-sub 9-pin: RS-232C / RS-422/485 *5 Modular jack 8-pin (2 ports): RS-232C / RS-485		
Comm. I/F	Modular jack 8-pin (2 ports): RS-232C *6		
Storage device	SD/SDHC card, USB flash drive		
Power supply	100 to 240 VAC		

*1 Only for V4Tx□ (□: 2, 4, 5, 6)

*2 Use Hakko Electronics' mounting panel adaptor "PAD-V610".

*3 Only for "picture" images and 3D parts. The other contents are displayed in 65,536 colors.

*4 Two points on the screen cannot be pressed simultaneously. For two-point pressing, use a switch on the screen and a function switch.

*5 When using the existing cable, use Hakko Electronics' conversion cable "D9-D25". When using a terminal block, use "TC-D9".

*6 Use Hakko Electronics' cable "V6-BCD" and make a conversion cable between MJ ↔ D-sub 9-pin. For the wiring diagram, refer to page 4.

- With RGB output

		V4T series	
		V4T2x0x-x	
MONITOUCH	- Front view		
	- Panel cut-out dimensions (mm)		
Display device	TFT color		
Colors	16 colors		
Resolution	640 × 480 dots		
Touch switch	Matrix		
Comm. I/F	Serial	D-sub 25-pin: RS-232C / RS-422/485 Terminal block: RS-422/485	
	Barcode	D-sub 9-pin (CN7): RS-232C *1	
RGB output	1CH		
Storage device	Dedicated memory card *1		
Power supply	85 to 265 VAC		

		Recommended models for replacement	
		V9100iS	
	- Front view		
	- Panel cut-out dimensions (mm) *2		
Display device	TFT color		
Colors	16.77 million colors *3		
Resolution	800 × 600 dots *4		
Touch switch	Analog *5		
Comm. I/F	D-sub 9-pin: RS-232C / RS-422/485 *6 Modular jack 8-pin (2 ports): RS-232C / RS-485		
Comm. I/F	Modular jack 8-pin (2 ports): RS-232C *7		
Storage device	Optional unit: GUR-02 (1CH) *4 SD/SDHC card, USB flash drive		
Power supply	100 to 240 VAC		

*1 Only for V4T2□ (□: 2, 4, 5, 6)

*2 Use Hakko Electronics' mounting panel adaptor "PAD-V610".

*3 Only for "picture" images, 3D parts, video images, and RGB display (when "GUR-10" or "GUR-11" is used). The other contents are displayed in 65,536 colors.

*4 The resolution specification is SVGA. Use the automatic resizing function when changing the MONITOUCH model setting in the screen program. The RGB signal is output in SVGA resolution.

*5 Two points on the screen cannot be pressed simultaneously. For two-point pressing, use a switch on the screen and a function switch.

*6 When using the existing cable, use Hakko Electronics' conversion cable "D9-D25". When using a terminal block, use "TC-D9".

*7 Use Hakko Electronics' cable "V6-BCD" and make a conversion cable between MJ ↔ D-sub 9-pin. For the wiring diagram, refer to page 4.

- Recommended models for replacement of V4C/V4W/V4B/V4H series

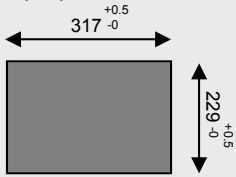
V4C/V4W/V4B/V4H series				
		V4C0x0x-x	V4C1x0x-x	V4W1x0x-x V4B1x0x-x V4H1x0x-x
MONITOUCH	- Front view			
	- Panel cut-out dimensions (mm)	 317 ^{+0.5} ₋₀ (width), 229 ^{+0.5} ₋₀ (height)		
Display device	STN color		STN monochrome	
Colors	16 colors		8 colors, 8-level grayscale	
Resolution	640 × 480 dots			
Touch switch	Matrix			
Comm. I/F	Serial	D-sub 25-pin: RS-232C / RS-422/485 Terminal block: RS-422/485		
	Barcode	D-sub 9-pin (CN7): RS-232C ^{*1}		
Storage device	Dedicated memory card ^{*1}			
Power supply	85 to 265 VAC			

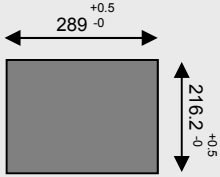
Recommended models for replacement	
V9100iC	
- Front view	
- Panel cut-out dimensions (mm) ^{*2}	 289 ^{+0.5} ₋₀ (width), 216 ^{+0.5} ₋₀ (height)
TFT color	
16.77 million colors ^{*3}	
640 × 480 dots	
Analog ^{*4}	
D-sub 9-pin: RS-232C / RS-422/485 ^{*5} Modular jack 8-pin (2 ports): RS-232C / RS-485	
Modular jack 8-pin (2 ports): RS-232C ^{*6}	
SD/SDHC card, USB flash drive	
100 to 240 VAC	

*1 Only for V4Cx□, V4W1□, V4B1□, and V4H1□ (□: 2, 4, 5, 6)
 *2 Use Hako Electronics' mounting panel adaptor "PAD-V610".
 *3 Only for "picture" images and 3D parts. The other contents are displayed in 65,536 colors.
 *4 Two points on the screen cannot be pressed simultaneously. For two-point pressing, use a switch on the screen and a function switch.
 *5 When using the existing cable, use Hako Electronics' conversion cable "D9-D25". When using a terminal block, use "TC-D9".
 *6 Use Hako Electronics' cable "V6-BCD" and make a conversion cable between MJ ↔ D-sub 9-pin. For the wiring diagram, refer to page 4.

- Recommended models for replacement of V4SC/V4SW/V4SB series

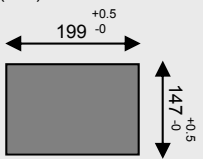
V4SC/V4SW/V4SB series			
		V4SC0x0x-x	V4SW1x0x-x V4SB1x0x-x
MONITOUCH	- Front view		
	- Panel cut-out dimensions (mm)	 199 ^{+0.5} ₋₀ (width), 147 ^{+0.5} ₋₀ (height)	
Display device	STN color		STN monochrome
Colors	16 colors		8-level grayscale
Resolution	320 × 240 dots		
Touch switch	Matrix		
Comm. I/F	Serial	D-sub 25-pin: RS-232C / RS-422/485	
	Barcode	D-sub 9-pin (CN1): RS-232C ^{*1}	
Power supply	24 VDC		

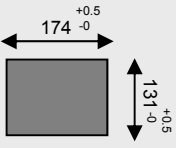
Recommended models for replacement	
V9060iTD	
- Front view	
- Panel cut-out dimensions (mm) ^{*2}	 174 ^{+0.5} ₋₀ (width), 131 ^{+0.5} ₋₀ (height)
TFT color	
260 thousand colors ^{*3}	
640 × 480 dots ^{*4}	
Analog ^{*5}	
D-sub 9-pin (with "DUR-00" attached): RS-232C / RS-422/485 ^{*6} Modular jack 8-pin (2 ports): RS-232C / RS-422/485	
Modular jack 8-pin (2 ports): RS-232C ^{*7}	
24 VDC	

*1 Only for V4SC02, V4SW12, and V4SB12
 *2 Use Hako Electronics' mounting panel adaptor "PAD-V606".
 *3 Only for "picture" images and 3D parts. The other contents are displayed in 65,536 colors.
 *4 The resolution specification is VGA. Use the automatic resizing function when changing the MONITOUCH model setting in the screen program.
 *5 Two points on the screen cannot be pressed simultaneously. For two-point pressing, use a switch on the screen and a function switch.
 *6 When using the existing cable with "DUR-00" attached, use Hako Electronics' conversion cable "D9-D25".
 When "DUR-00" is not attached (except when connecting a Mitsubishi A series CPU), use Hako Electronics' conversion cable "MJ2-PLC". When connecting with a Mitsubishi A series CPU, use "V706-ACPU".
 *7 Use Hako Electronics' cable "V6-BCD" and make a conversion cable between MJ ↔ D-sub 9-pin. For the wiring diagram, refer to page 4.

- Wiring diagram for MJ ↔/ D-sub 9-pin conversion cable for connection with a barcode reader

When replacing the V4 unit with the V9 unit, use Hakko Electronics' cable "V6-BCD" and make a conversion cable between MJ ↔ D-sub 9-pin.

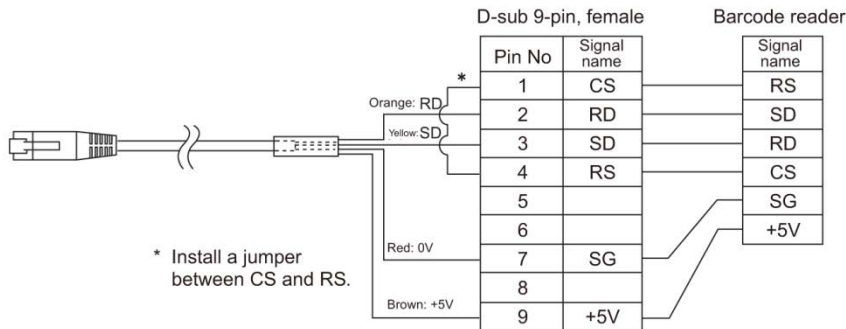

- Screen program transfer

- V4 series

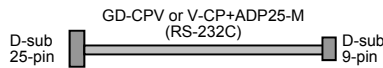

[Screen configuration software]

V-SFT-5 (Ver. 5)
 Windows 98SE / NT4.0 / Me / 2000 / XP / XP 64 Edition / Vista (32bit, 64bit) / 7 (32bit, 64bit) / 8 (32bit, 64bit) / 8.1 (32bit, 64bit) / 10 (32bit, 64bit)

* It is possible to make a cable by yourself. For details on wiring, refer to the Hardware Specifications Manual of the relevant V4 series unit.



- V9 series

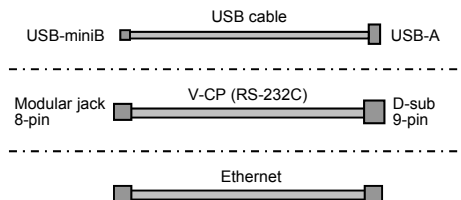

[Screen configuration software]

V-SFT-6 (Ver. 6)
 Windows XP / XP 64 Edition / Vista (32bit, 64bit) / 7 (32bit, 64bit) / 8 (32bit, 64bit) / 8.1 (32bit, 64bit) / 10 (32bit, 64bit)

* Screen programs can also be transferred by using an SD card or USB flash drive.
 * The LAN port of the V9 unit is compatible with Auto-MDIX. Both straight and cross cables are usable in either presence or absence of a hub.

- Screen program conversion

The V4 series can be replaced with the V9 series by converting the V4 series screen program using V-SFT-6 (V series screen configuration software). However, note that 100% compatibility cannot be maintained and some functions may be limited or may not be used after replacement. For details, refer to the V9 Series File Conversion Manual.

- Mounting panel adaptor (PAD-Vxxx)

A mounting panel adaptor is used when installing a new MONITOUCH model into the panel cut-out hole of the V4 series.

(1) Remove the V4 series unit from the panel.

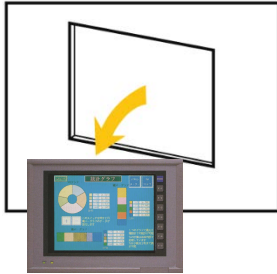

(2) Install the mounting panel adaptor.

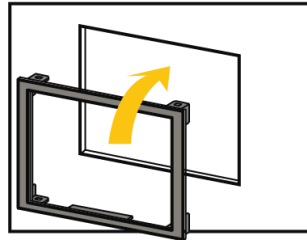

(3) Install a V9 series unit.

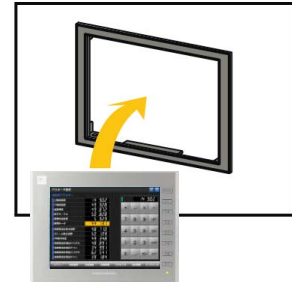

* The indicated recommended model for replacement can be used with minimal restrictions. Please note that other models not described here can also be used; make a selection according to your system requirements.

Hakko Electronics Co., Ltd.

Overseas Sales Dept.

TEL: +81-76-274-2144 FAX: +81-76-274-5136

<https://monitouch.fujielectric.com/>